

Team-building and information flow for large groups such as online hackathons

Building on Laugeri's Three Contracts model,
Leonardo 3.4.5 team profile, and matchmaking process

Fabio Balli

info@openvillage.ch

Last / editable versions

www.openvillage.ch

Archive for

www.doi.org/10.5281/zenodo.3743244



Licence Creative Commons
Attribution ShareAlike 4.0

April 24-26, 60'000 people will join the European Union challenge.¹

Total time invested: 164 years,² plus the wisdom of the crowd.³

Imagine these 60'000 people transform into one living organism.⁴

What could we dream this 'super-body' could achieve?

Clickable links:

1. Euvsvirus.org
2. With an average contribution of 24 hours per person
3. ncase.me/crowds
4. The event is only an example to illustrate the concept.

Common hackathons fails

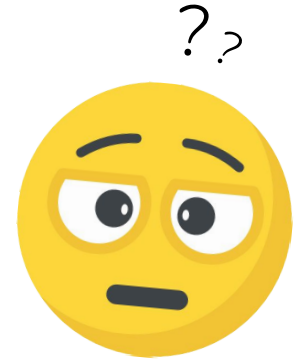
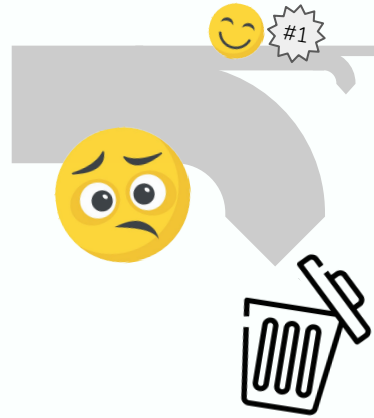
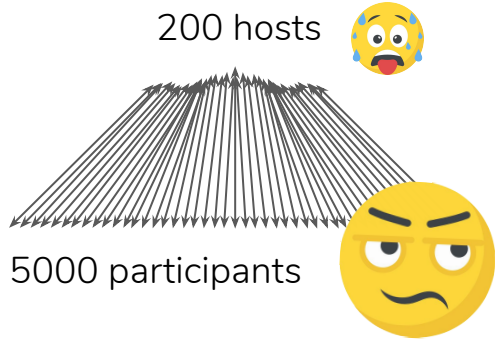

information overload

+ waste of resources

= loss of motivation

as little information
as needed

+ coordinated work
across teams

= feeling of belonging,
projects sustain

Changing group dynamics to value mutual support

Propose me X.
xxx

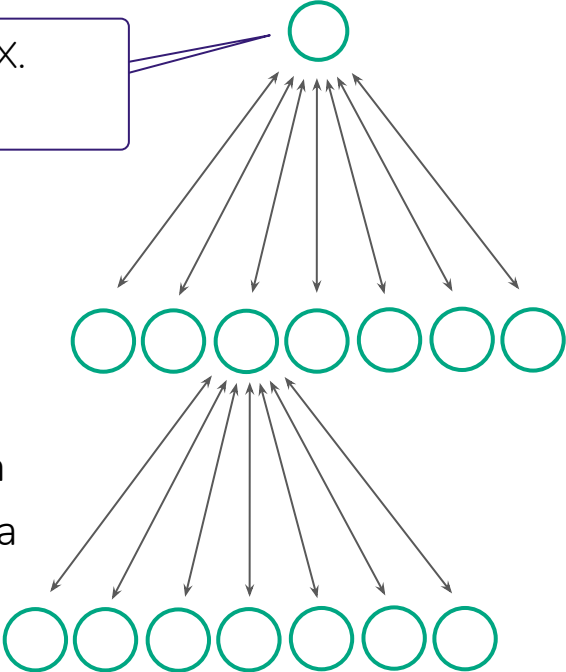

Agree on X and
propose it to me.

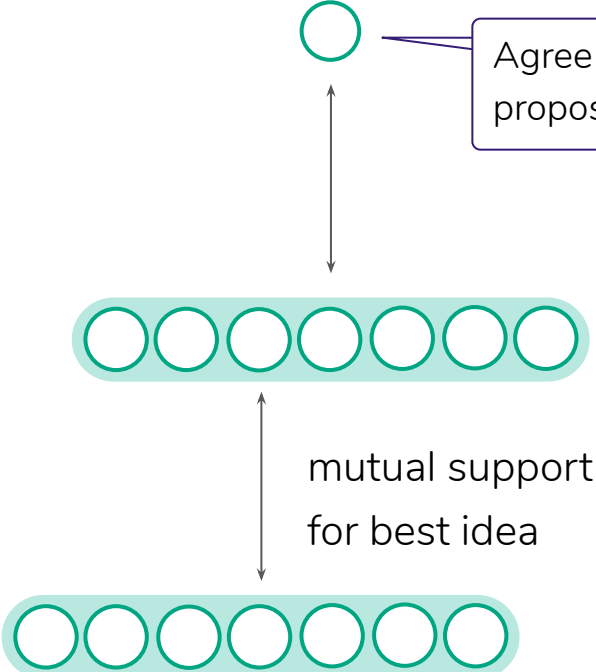

In practice

Onboarding 7 people

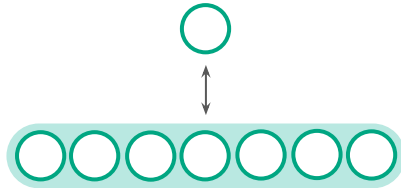

lvl	people	topic	begin
1	1	Fight COVID	
2	7	?	

Onboarding 7 people

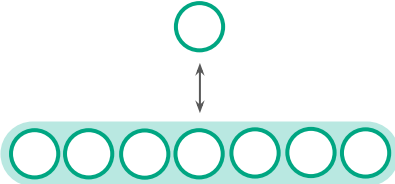

lvl	people	topic	begin
1	1	Fight COVID	
2	7	?	

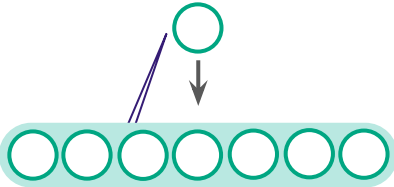

Please agree on 7 topics to fight COVID and propose them to me.

Onboarding 7 people

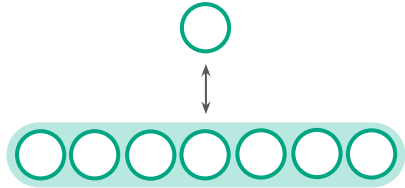

lvl	people	topic	begin
1	1	Fight COVID	
2	7	?	

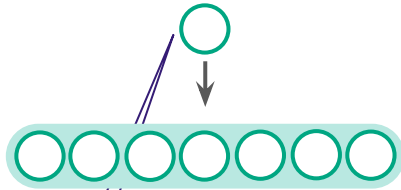

Please agree on 7 topics to fight COVID and propose them to me.



I propose Education, Health

What about Research?

Onboarding 7 people

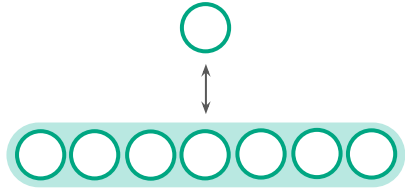

lvl	people	topic	begin
1	1	Fight COVID	
2	7	?	

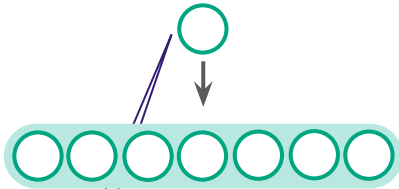

Please agree on 7 topics to fight COVID and propose them to me.



I propose Education, Health

What about Research?

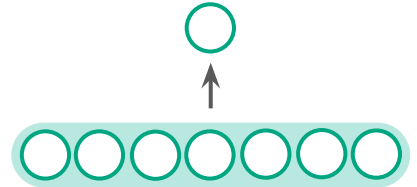

We agree on Health & Medicine, Education, Social Cohesion, ...

Onboarding 49 more people

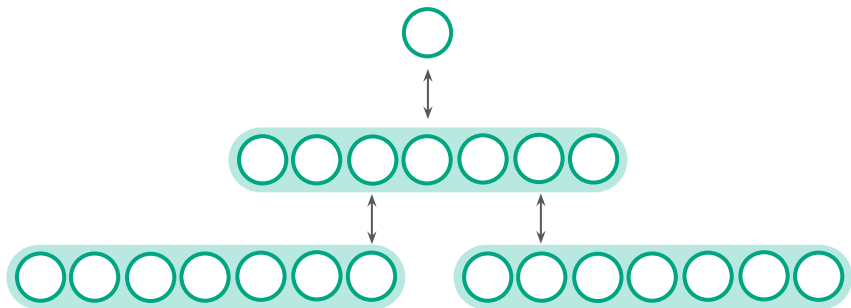

lvl	people	topic	begin
1	1	Fight COVID	
2	7	Health & Medicine	
3	49	?	

Onboarding 49 more people

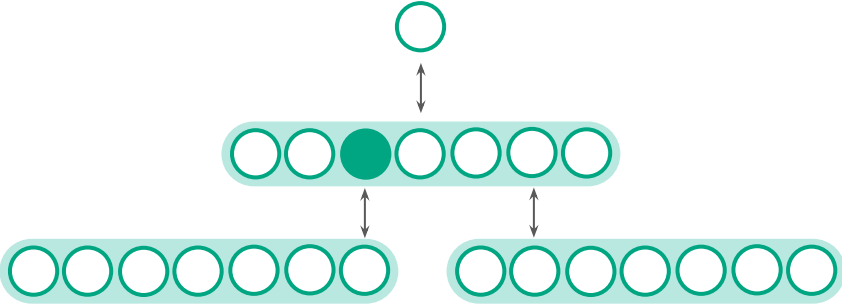

lvl	people	topic	begin
1	1	Fight COVID	
2	7	Health & Medicine	
3	49	?	

Let's take ●.

Onboarding 49 more people

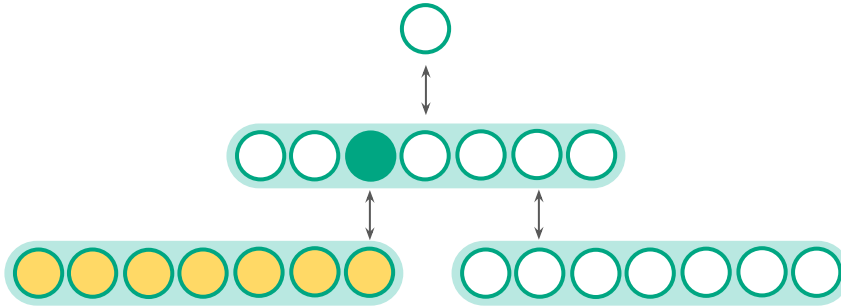

lvl	people	topic	begin
1	1	Fight COVID	
2	7	Health & Medicine	
3	49	?	

● asks ○○○○○○○ to agree on seven topics.

○○○○○○○ share the seven topics they agreed on to ●.

Onboarding 49 more people

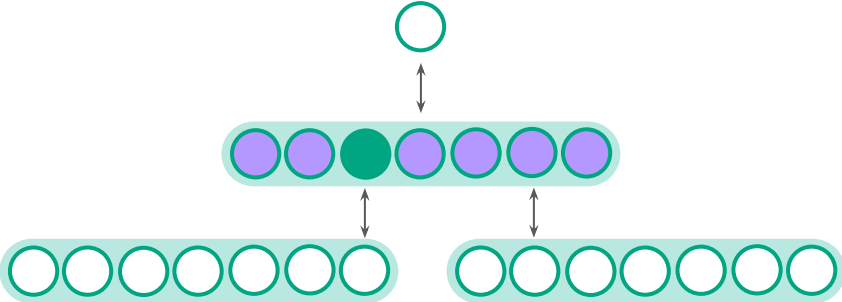

lvl	people	topic	begin
1	1	Fight COVID	
2	7	Health & Medicine	
3	49	?	

● agrees with ○○○○○○○ to validate / adjust the 49 topics.

Onboarding 49 more people

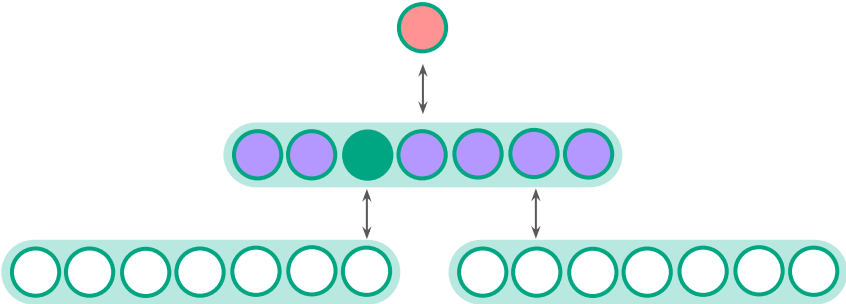

lvl	people	topic	begin
1	1	Fight COVID	
2	7	Health & Medicine	
3	49	?	

If needed, ask questions to , who answers them.

Onboarding 49 more people

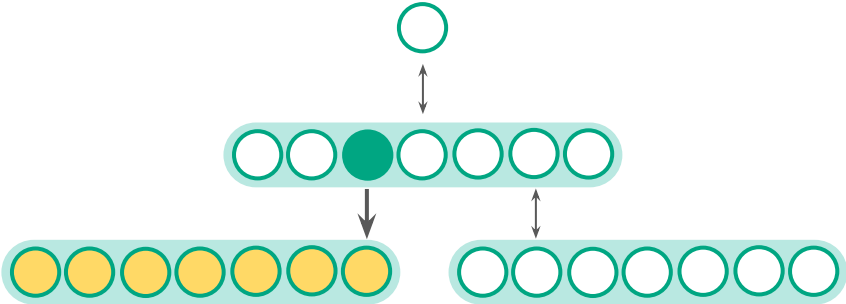

lvl	people	topic	begin
1	1	Fight COVID	
2	7	Health & Medicine	
3	49	One open-science ventilator	

● validates / adjusts and comes back to  .

Scalable

An illustration based on an event with 60'000 people.

343 people

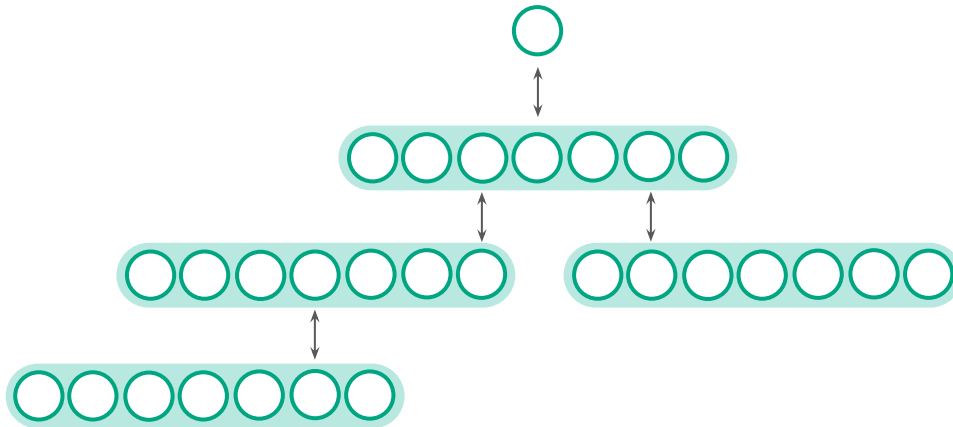

lvl	people	topic	begin
1	1	Fight COVID	
2	7	Health & Medicine	
3	49	One open-science ventilator	
4	343	?	19.04

2401 people

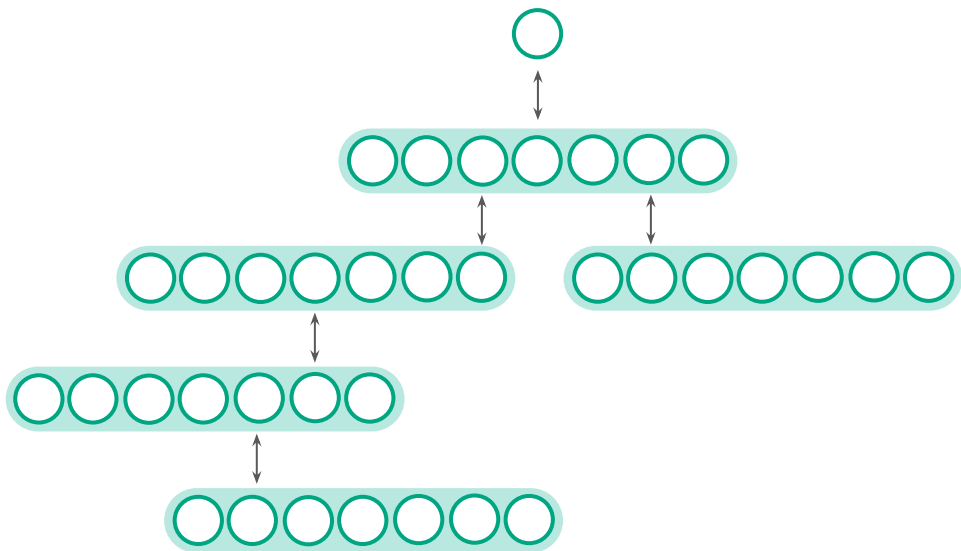

lvl	people	topic	begin
1	1	Fight COVID	
2	7	Health & Medicine	
3	49	One open-science ventilator	
4	343	Gather field needs	19.04
5	2401	?	20.04

16807 people

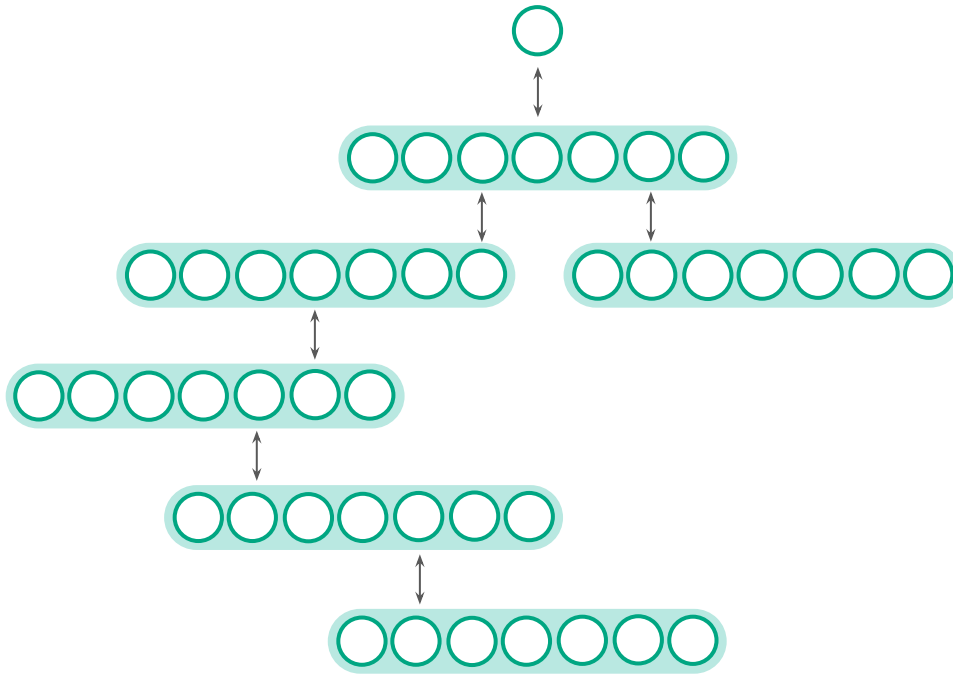

lvl	people	topic	begin
1	1	Fight COVID	
2	7	Health & Medicine	
3	49	One open-science ventilator	
4	343	Gather field needs	19.04
5	2401	List resources required for local production	20.04
6	16807	?	21.04

117649 people

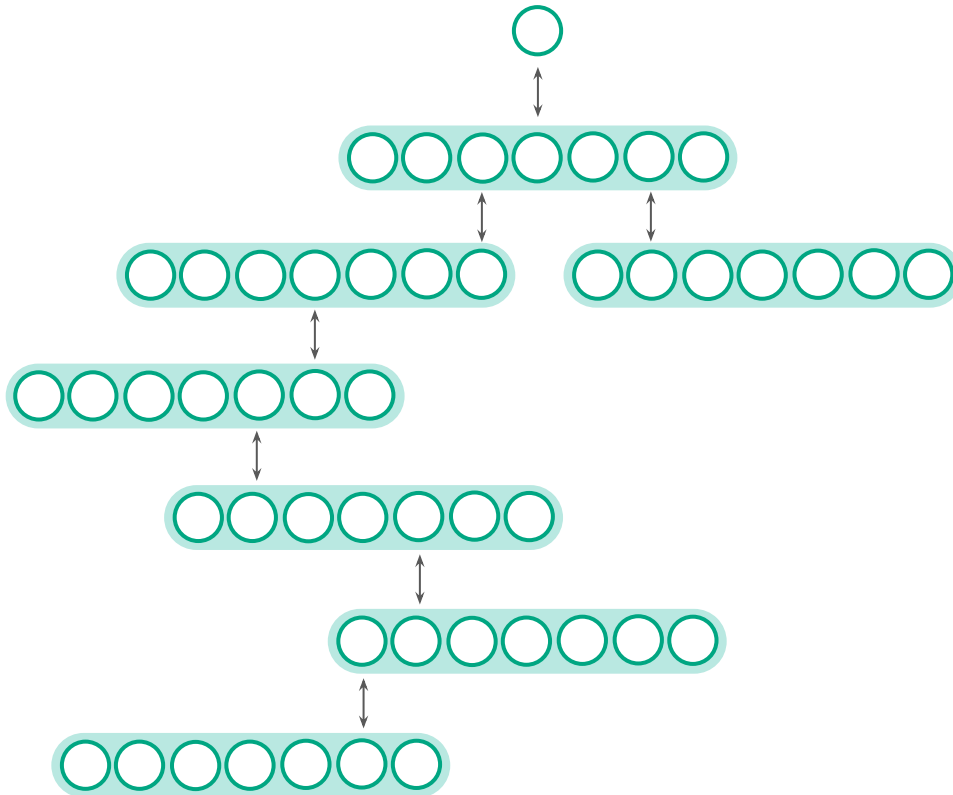

lvl	people	topic	begin
1	1	Fight COVID	
2	7	Health & Medicine	
3	49	One open-science ventilator	
4	343	Gather field needs	19.04
5	2401	List resources required for local production	20.04
6	16807	In Central Europe	21.04
7	117649	?	22.04

117649 people

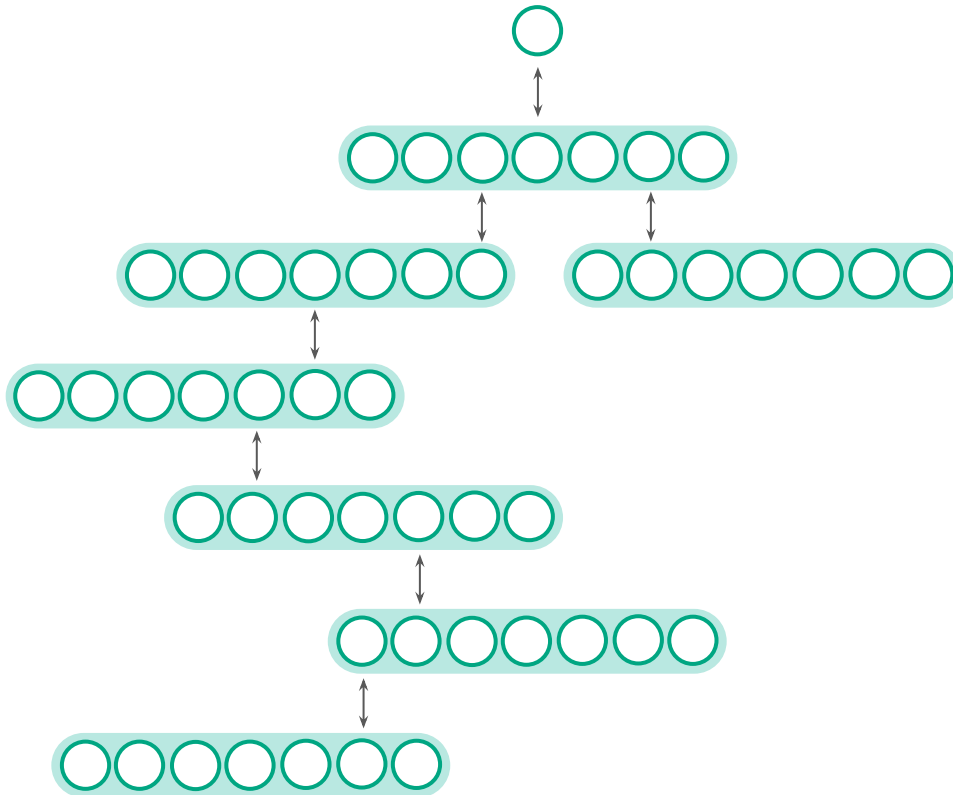

lvl	people	topic	begin
1	1	Fight COVID	
2	7	Health & Medicine	
3	49	One open-science ventilator	
4	343	Gather field needs	19.04
5	2401	List resources required for local production	20.04
6	16807	In Central Europe	21.04
7	117649	In Switzerland	22.04

This replicates how the body works:

- ✓ as little information as needed:
each person closely interacts with **14 people**.
- ✓ coordinated work across teams:
every individual contributes to one congruent whole.

Coordinators can **rely on autonomous teams** to support them.

Individuals support each other to be part of a **meaningful whole**.

There is a feeling of belonging, and projects sustain.

1 in 49 outcomes possible

2'400 participants
coordinate 60 open
versions being built



880'000 ventilation machines
needed to avoid deaths

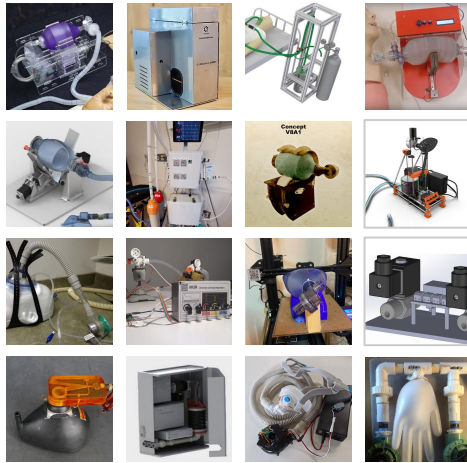

✓one freely reproducible machine

- ready for mass/crowd production in all countries
- iteratively improved/validated

Technical implementation

Team building

L3 agreed on **49 topics** through rapid iterations with L2 (and L2 with L1 if needed)

Prioritize 10 topics you care of

Open source ventilator

Handrub production

Knowledge transfer

Infection prevention

etc.

Your preferences at work

stability		change
short term		long term
product		method
focus		consens
centralized		decentralised

→ To onboard, L4 prioritize **10 topics** they prefer and fill a **team profile** such as EU funded Leonardo 3.4.5

April 19, **343 people** (L4) are invited to a team based on their preferences.



L4 agree on **343 topics** through rapid iterations with L3 (and L3 with L2, L2 with L1 if needed)

Interfaces

User registers

Michele

- **profile:** stabilization
- **available:** from 19.04
- **prioritized topics:**
 - 1.3.2) ventil resources
 - 1.3.4) ventil certification
 - 3.4.2) education for elders

→ gets allocated to highest bucket available

19.04	4	343 p
20.04	5	2401 p
21.04	6	16807 p
22.04	7	117649 p

→ is invited to join team based on preferences (algorithm)

You are invited to join group 1.1.7 ventil certification.

Channel #1.3.4

The topic coordinator 1.3 will contact you.

→ Then

- group agrees on 7 topics to covers 1.3.4
- once topics validated by 1.3, group is asked to create channels 1.3.4.1 to 1.3.4.7

Website, database, matchmaking algorithm

Channels

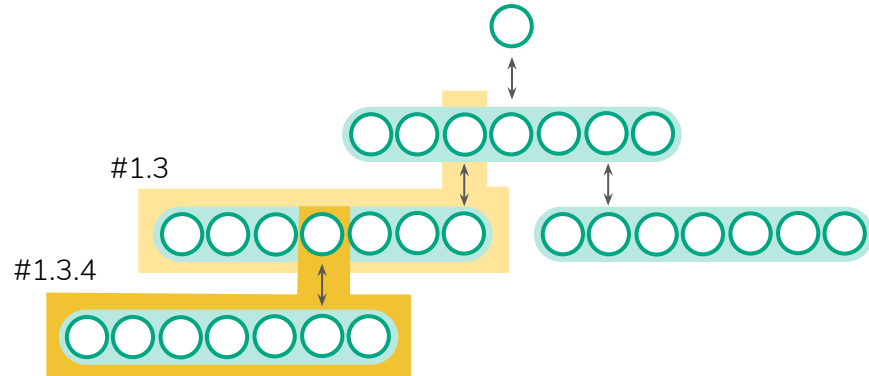

Thank you.