

An Application of a Cost Minimization Model in Determining Safety Stock Level and Location

Bahareh Amirjabbari, Nadia Bhuiyan

Abstract—In recent decades, the lean methodology, and the development of its principles and concepts have widely been applied in supply chain management. One of the most important strategies of being lean is having efficient inventory within the chain. On the other hand, managing inventory efficiently requires appropriate management of safety stock in order to protect against increasing stretch in the breaking points of the supply chain, which in turn can result in possible reduction of inventory. This paper applies a safety stock cost minimization model in a manufacturing company. The model results in optimum levels and locations of safety stock within the company's supply chain in order to minimize total logistics costs.

Keywords—Cost, efficient inventory, optimization, safety stock, supply chain

I. INTRODUCTION

IN today's competitive environment, applying the lean paradigm has been extended to the field of supply chain management [1]-[11]. All contributors of a supply chain, no matter to which industry they belong, aim to follow a lean philosophy to make their business processes more and more efficient in order to survive on the market. Manufacturers are one of these contributors and inventory plays a paramount role in their efforts to become lean [12]-[14]. There are different inventory drivers such as level of supply chain collaboration and visibility, forecast accuracy, order pattern, and safety stock policy, among others. Therefore, proper management of inventory and consequently safety stock as one of its drivers has become critical objective for these chain's contributors towards leanness. In this paper, we propose a safety stock cost minimization model in a manufacturer case company who tries to manage the inventory across its supply chain efficiently, and towards this goal, efficient levels and locations of safety stock becomes more and more highlighted as a precedent condition. According to the literature, there are different approaches and methods for determining the safety stock under different

situations [15]-[27]. Consequently, optimization model of safety stock could be built on different objectives. Minimization cost, maximization service level, and aggregate considerations are examples of such objectives [28]. Optimal determination approaches based on cost and service level objectives are more appropriate for practical applications [26]. One of the vital goals of the enterprise is to maximize earnings under certain investment conditions [29]. On the other hand, as reducing costs of materials, equipment, and labor is difficult at best in today's competitive market, enterprises are more interested in targeting logistics costs in this regard [29]. In this paper, minimization of logistics costs is selected as the basis of the determination of optimum safety stock. Logistics costs are mainly related to procurement and supply, manufacturing process, and after sales service. Thus, holding and shortage costs are selected as representations of logistics costs in the optimization model. "Supply chain is the lifeblood of the corporation and sales revenue depends on the supply chain delivering product availability" [30]. Indeed, product availability is a critical measure for the performance of logistics and supply chain [31]. Any obstacles at any node and level of supply chain can result in unavailability of products to their customers [32]. There are different issues that cause disruptions and unavailability of products in the supply chain, as for example variability, whether in demand or lead time; quality issues; or internal and external issues such as low delivery performances, improper scheduling, inadequate product capacity, poor maintenance, among others. These instabilities in the chain affect costs such as setup and expediting costs and they also affect material plans like shortage or excess of components [18]. Fig. 1 is a schematic of a supply chain with its nodes such as different tiers of suppliers, producer, assembly, distributors, and customer. Any actions taken by any member of the chain can affect the profitability of the others. Therefore, companies have great interest in having better coordination among the contributors of their supply chain [28]. Safety Stock is essential to compensate for the weakness of the supply chain for part availability and this factor has been considered in the selected optimization model. In the next section, we discuss the case study.

Bahareh Amirjabbari is with the Dept. Mechanical and Industrial Engineering of Concordia University, 1515 St. Catherine St. West, Montreal, QC, H3G 1M8, Canada (phone: +1-514-569-9151; e-mail: b_amirja@encs.concordia.ca).

Nadia Bhuiyan is with the Dept. Mechanical and Industrial Engineering of Concordia University, 1515 St. Catherine St. West, Montreal, QC, H3G 1M8, Canada (e-mail: bhuiyan@alcor.concordia.ca).

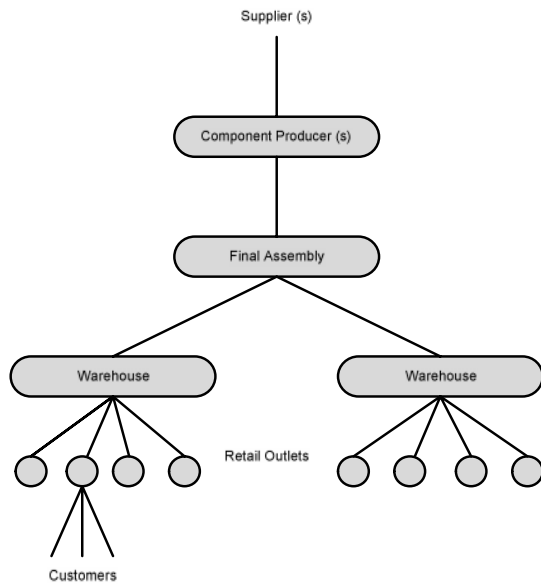

Fig. 1 A Schematic of a Supply Chain

II. CASE STUDY

The company under study, which we will hereinafter refer to as ABC for the purpose of confidentiality, is a manufacturer in the aerospace industry. The company is characterized by high demand variability and long lead time, among others. ABC is a multi-stage manufacturer. Tiers of suppliers, procurement, manufacturing, final assembly, and customers (internal and external) are different nodes of the ABC's supply chain. The downstream nodes are the upstream nodes' customers, and the replenishment lead time of customer nodes is the order waiting time provided by their upstream nodes. In addition, ABC has a generally structured multi-stage system and there is no restriction with respect to the number of predecessors and successors of any node. Such multi-stage systems focus considerable attention on setting and positioning safety stock [33]. ABC has two different manufacturing plants (MFs). The procurement department of the company is responsible for procuring the raw materials or semi-finished parts through suppliers to manufacturing plants or even supplying parts from one manufacturing plant to another (inter plants transfers). Indeed, the word "supplier" in the model could be the representative of the external supplier or internal manufacturing entity. It should be noted that procurement's location can be different from manufacturing ones. Finished parts from manufacturing entities have two internal customers that pull their outputs; they are Assembly (ASSY) and Aftermarket (AFM). These two latter entities are the last stages of the internal chain of the company just before the end customer. There are also some external supplied finished parts required for Assembly and Aftermarket that the procurement department is again in charge of supplying them. The Assembly entity has different finished product families with their own specifications. Therefore, if availability of parts (right parts at right time) can be assured for the internal

customers, on-time delivery performance to the end customer will be assured as well. This availability should be guaranteed through safety stock, but the optimum safety stock level and location should also minimize logistics costs.

III. MODEL DESCRIPTION

The optimization model is presented through different possible value streams of each finished product family of the company to result in the optimum level of safety stock with its optimum location in the stream. Each of these value streams can have different combinations of the chain's contributors before the end customer. In order to limit the number of stages and for simplification, only the last two stages of those value streams that have more than two nodes before the internal customer stage are selected. Therefore, all the previous stages and their connections are being excluded and their performances are being captured only through the input of the latest second stage. The other reason for this limitation is the difficulty in defining the shortage costs in upstream stages of the chain due to lack of visibility and control. Furthermore, the objective of the model is cost minimization, and the upstream stages' contributions towards cost are significantly less than the downstream stages, thus this simplifying assumption should have a negligible effect on overall results. Although, there is a sample (Value Stream 4) presented in "Computational Results" section that goes beyond this limitation just to show the applicability of the model for the whole chain from end to end point.

Shortage cost, overage cost, and delivery performances (percentage of product availability) are the inputs of the model. Different combinations of raw material (semi-finished part) and finished part are considered as indices in the model based on the selected value streams.

IV. MODEL FORMULATION

For all value streams, the notations of the model are as follows:

A. Sets and Indices

- i Raw material/ semi-finished part
- p Finished part
- u Customer (ASSY, AFM)

B. Variables

- K_i Delivery performance of procurement to manufacturing
- K_p Delivery performance of manufacturing or procurement to customers

* Shaded sections are used to make the FFR report applicable.

* Theoretical safety stock based on historical data for the required period.

* Safety Stock On-Hand = Max (0, Min (Stock - Required Past, Theoretical Safety Stock))

* $q^* = \text{Max}(0, \text{Min}(\text{Stock} - \text{Required Past} - \text{Safety Stock On Hand}, \text{Required Current}))$

* $P'_p = (q^*/\text{Required Current}) \times 100$

TABLE I
FIRST FILL RATE REPORT SAMPLE

Part Code	Entity	Calendar Week	Stock	Required Past	Required Current	% Met Global (K'p)	Theoretical Safety Stock	Safety Stock On-Hand	q*	P'p
AF1	MF	11.2010	2100	500	500	100	0	0	500	100%
AF1	MF	12.2010	1100	700	560	100	300	300	100	17.85%

C. Parameters¹

P_i Supplier delivery performance to procurement (if supplier is a manufacturing plant, then P_i would be manufacturing performance for semi-finished part)

P_p Manufacturing performance for finished part (ratio between on time manufactured and planned manufactured of finished part)

C_s Cost of shortage

C_o Cost of overage

x_i Raw material/semi-finished part safety stock

x_f Finished part safety stock

q_i Raw material/semi-finished part quantity ordered

q_p Finished part quantity ordered

* q On-time delivered quantity of raw material/ semi-finished part or finished part

K_i is the summation of the availability percentage of raw material/semi-finished part for manufacturing through procurement based on the absolute suppliers' performances (P_i) and the availability percentage of procurement's safety stock for that part (x_i/q_i). Indeed, procurement can deliver whatever quantities they received on time through suppliers plus their safety stock to the manufacturing. K_p is the summation of the availability percentage of the finished part which is dependent on the manufacturing performance (P_p) and also their previous stages' performances (K_i) and the availability percentage of manufacturing's safety stock for that part (x_p/q_p). Likewise, manufacturing can deliver whatever quantities of finished parts they can produce on time which is also dependent on the deliveries of their previous stages in the chain plus their own safety stock quantities to their customers (ASSY and AFM).

The related formulas of K_i and K_p are as (1) and (2):

$$K_i = P_i + \frac{x_i}{q_i} \tag{1}$$

$$K_p = P_p \times K_i + \frac{x_p}{q_p} \tag{2}$$

In the cases that the finished part is directly procured through the external supplier for the customers, K_p formula will be equal to (1).

P_i and P_p are calculated as average numbers based on historical data from the last year. A report called the First Filled Rate (FFR) is used for calculation of these parameters. This report is used to present the availability of the right part at the time that is required. The FFR result takes into account the total on hand stock in its calculation which does include safety stock as well.

It should be noted that P_i and P_p should be the absolute delivery performance of supplier and manufacturing without the contribution of the safety stock that may be used during last year. Therefore, the safety stock has been excluded from the FFR report for this purpose. In addition, when there are two stages in the selected value stream, the FFR report also includes the contribution of the last second stage's performance in its results for calculating the last stage's performance which is manufacturing. Therefore, this must also be excluded. Indeed, P_p is the manufacturing performance without taking into account the stockout of raw materials [15]. Hence, to calculate the required absolute value of P_p from FFR, three other parameters should be defined. First one is K'_p which is the exact number extracted through FFR, the other one is P'_p which is the FFR's result excluding safety stock contribution. And the third one is K'_i which is the historical previous stage's delivery performance; by dividing this by P'_p the absolute manufacturing performance is measured ($P_p = P'_p / K'_i$). Indeed, there is no direct report for tracking absolute manufacturing performance in the case company. Table I is a snapshot of a sample FFR and presents the formulas used to eliminate the safety stock from its calculation. As shown through the table, in the 12th week of 2010, the FFR report gives 100% ($K'_p = 100\%$) as the delivery performance of manufacturing to its customer because it takes into account the 300 pieces of safety stock for meeting the past and current requirements; however, safety stock must be excluded through this calculation and P'_p becomes 18%. The

¹ It should be noted that in parameters "p" is using for only those finished parts that are manufactured in ABC. Indeed, for those finished parts that are procured directly through suppliers, indices of "i" is used.

next step for calculating the absolute manufacturing performance would be the elimination of the effect of the previous stage's performance (K_i).

About the calculation of P_i in FFR it should be noted that if the supplier delivers a part on time with the right quality, but defects occurs during transportation from procurement to manufacturing or customer, although the delivery performance of the supplier is 100%, P_i will be 0% since the part is not available for use. Therefore, P_i can also be called as "part availability" instead of supplier delivery performance.

It is worth mentioning here that ABC has three different strategies for managing its inventory. It applies a two-bin kanban system for the parts with low costs. On the other hand, the company is moving towards excellence and applying a pull system for managing the inventory of those parts that have high cost with high volume; but this system is not applicable for all parts due to the complexity and lack of required conditions such as having suppliers with delivery performance of higher than 80% and with a supermarket of finished goods, having parts with a robust process and steady volume, among others. Therefore, its inventory strategy for the rest of the parts with high cost and low volume is MRP system. Based on this, a safety stock strategy is really required for this latter category of parts. Consequently for parts managed by the MRP system, quantities within the replenishment lead time have found as the most appropriate definition for q_i and q_p to result in the proper level of safety stock for the company through the model. The first step for their calculation would be identifying the planned order quantity of each specific part (raw/semi or finished part) per week according to its planning parameters which it itself is related to ordering policies. Some of the examples of planning parameters in this regard are Lot for Lot, Weekly Batch, 2 Weeks Batch, and Fixed Order Quantity, among others. The second step would be the calculation of the average weekly forecast demand of that specific part for the next year. After that, the division of the planned order quantity and average weekly demand would result in the replenishment lead time in weeks. ABC has decided to run the model and update it every quarter, therefore, the weekly demand of the next quarter would be merged based on the calculated replenishment lead time. And finally, the maximum quantity of this combination will be selected as q_i/q_p in order to allow the safety stock strategy to support the *worst case*. In addition, it should be mentioned that the planned order quantity for a manufacturing part should always be calculated through its demand only in the plant in which it is being manufactured because the part will be replenished based on the ordering policy in that plant.

Shortage costs (costs of safety stock violation) have different definitions for raw materials (semi-finished parts) and finished parts as they are located in different stages within the chain and their shortages have different effects on the system. The shortage cost of the raw material (semi-finished part) is the summation of the expediting cost on the supplier, expediting cost on transportation, and overtime of the manufacturing section. On the other hand, shortage of the

finished part which is required by Assembly, causes disruptions and stock not pulled for all the other parts related to that finished part and also its finished product in different locations of the supply chain. In addition, shortage of the finished part causes the finished assembled product to be held up unreleased. Therefore, the shortage cost is defined as follows:

$$C_{sp} = (\text{Standard cost of the finished assembled product} * \text{average days of holding finished assembled product due to the shortage of the specific finished part during last year} * 0.1) / 365$$

Coefficient of 10% in the above formula is the annual interest rate that company could receive by putting this amount of money in the bank, although the company has this as inventory buckets instead of cash right now.

The cost of shortage of the finished part required by Aftermarket is defined as the profit that the company will lose by not having the part ready to deliver on-time to the customer, which is the direct cost. Besides that, there are many intangible effects of this shortage that are called indirect costs and are difficult to gauge accurately [34]. One of them is loss of customers' goodwill that may turn them to other competitors in the future. On the other hand, at the time of shortage of a specific part, the Aftermarket department may rent out another more expensive part instead of the required one to the customer until it arrives. Therefore, shortage cost of these parts is defined as four times of the standard cost (Std.Cost) of the finished part.

The cost of overage is defined as the interest that the company is losing by holding inventory instead of having it in cash. Hence, it is the multiplication of standard cost of the part and the annual interest rate (10%).

Some samples of value streams associated with their models' formulas are presented below:

Value stream 1 shown in Fig. 2 consists of one raw material/semi-finished part used to make one finished part which has two customers of ASSY and AFM. The corresponding objective function and constraints are presented by (3).

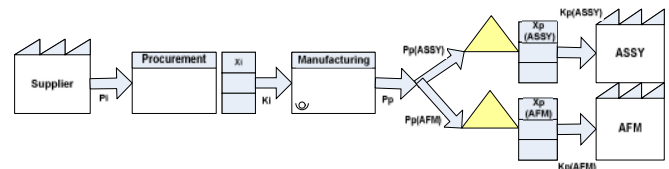

Fig. 2 Value Stream 1

$$\begin{aligned} \text{Min}C &= C_{si}q_i(1 - P_i) + C_{oi}q_i(K_i - P_i) + \sum_{u=1}^2 C_{spu}q_{pu}(1 - K_{pu}) \\ &+ \sum_{u=1}^2 C_{opu}q_{pu}(K_{pu} - (P_{pu} \times K_i)) \end{aligned}$$

SubjectTo:

$$K_i \leq 1$$

$$\begin{aligned}
 &K_i \geq P_i \\
 &K_{pu} \leq 1, \quad u=1,2 \\
 &K_{pu} \geq P_{pu} \times K_i, \quad u=1,2
 \end{aligned} \tag{3}$$

If for this case, there were two different kinds of finished parts but again in demand with both customers, then there should be a summation on both indices of finished part (p) and customer (u) in the objective function:

$$\begin{aligned}
 MinC &= C_{si}q_i(1 - P_i) + C_{oi}q_i(K_i - P_i) \\
 &+ \sum_{p=1}^2 \sum_{u=1}^2 C_{spu}q_{pu}(1 - K_{pu}) \\
 &+ \sum_{p=1}^2 \sum_{u=1}^2 C_{opu}q_{pu}(K_{pu} - (P_{pu} \times K_i))
 \end{aligned}$$

SubjectTo:

$$\begin{aligned}
 &K_i \leq 1 \\
 &K_i \geq P_i \\
 &K_{pu} \leq 1, \quad u, p = 1, 2 \\
 &K_{pu} \geq P_{pu} \times K_i, \quad u, p = 1, 2
 \end{aligned} \tag{4}$$

In value stream 2 which is shown in Fig. 3, two raw materials/semi-finished parts are used to make one finished part which has two customers, ASSY and AFM. The corresponding model is also presented by (5).

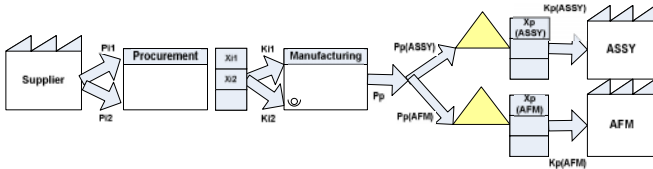

Fig. 3 Value Stream 2

$$\begin{aligned}
 MinC &= \sum_{i=1}^2 C_{si}q_i(1 - P_i) + \sum_{i=1}^2 C_{oi}q_i(K_i - P_i) \\
 &+ \sum_{u=1}^2 C_{spu}q_{pu}(1 - K_{pu}) \\
 &+ \sum_{u=1}^2 C_{opu}q_{pu}(K_{pu} - (P_{pu} \prod_{i=1}^2 K_i))
 \end{aligned}$$

SubjectTo:

$$\begin{aligned}
 &K_i \leq 1, \quad i=1,2 \\
 &K_i \geq P_i, \quad i=1,2 \\
 &K_{pu} \leq 1, \quad u=1,2 \\
 &K_{pu} \geq P_{pu} \prod_{i=1}^2 K_i, \quad u=1,2
 \end{aligned} \tag{5}$$

As before, if there were two different finished parts for the same situation, the model would be changed as (6):

$$\begin{aligned}
 MinC &= \sum_{i=1}^2 C_{si}q_i(1 - P_i) + \sum_{i=1}^2 C_{oi}q_i(K_i - P_i) \\
 &+ \sum_{p=1}^2 \sum_{u=1}^2 C_{spu}q_{pu}(1 - K_{pu}) \\
 &+ \sum_{p=1}^2 \sum_{u=1}^2 C_{opu}q_{pu}(K_{pu} - (P_{pu} \prod_{i=1}^2 k_i))
 \end{aligned}$$

SubjectTo:

$$\begin{aligned}
 &K_i \leq 1, \quad i=1,2 \\
 &K_i \geq P_i, \quad i=1,2 \\
 &K_{pu} \leq 1, \quad p, u = 1, 2 \\
 &K_{pu} \geq P_{pu} \prod_{i=1}^2 K_i, \quad p, u = 1, 2
 \end{aligned} \tag{6}$$

As can be seen through the constraints of the model, the company's objective is to have 100% delivery performances. Therefore, the upper boundaries of both stages are assigned to 1 in order to not to allow the model to impose a shortage to the system. Of course, these upper bounds could be less than 1 based on the service level goals in different cases. By this definition of the model, costs factors would be the indicators for the location of the safety stock and its level would be identified based on the boundaries of the delivery performances. This optimization model will be linear if there is only one raw material/semi-finished part and optimum point with minimum cost will happen only in one of the four boundaries. Based on this, we assume the optimization model as (7) with only one customer for finished part:

$$\begin{aligned}
 MinC &= C_{si}q_i(1 - P_i) + C_{oi}q_i(K_i - P_i) + \\
 &C_{spu}q_{pu}(1 - K_{pu}) + C_{opu}q_{pu}(K_{pu} - (P_{pu} \times K_i))
 \end{aligned}$$

SubjectTo:

$$\begin{aligned}
 &K_i \leq 1 \\
 &K_i \geq P_i \\
 &K_{pu} \leq 1 \\
 &K_{pu} \geq P_{pu} \times K_i
 \end{aligned} \tag{7}$$

Varying the location of the safety stock based on the optimum point in two sample cases of the linear model in (7) are shown with the following feasible regions in Fig. 4 and 5. In addition, Table II presents the comparison between the costs in each of the cases and also the recommended location of the model for the safety stock. In this comparison, it is assumed that q_i and q_p are equal.

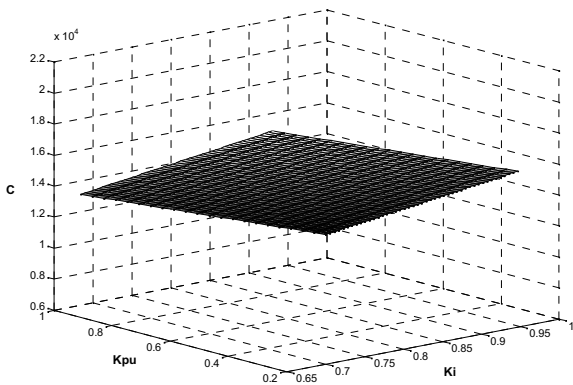

Fig. 4 Location of Safety Stock-Case 1

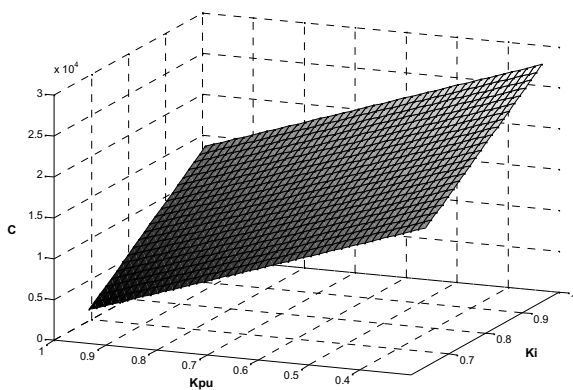

Fig. 5 Location of Safety Stock-Case 2

TABLE II
COST COMPARISON AND SAFETY STOCK LOCATION

Case	Costs Comparison	Safety Stock for Raw Material	Safety Stock for Finished Part
Fig. 4	$C_{sp} > C_{si} > C_{op} > C_{oi}$	Yes	Yes
Fig. 5	$C_{oi} > C_{sp} > C_{op} > C_{si}$	No	Yes

In order to make the results of the model more effective for the company, one of the most problematic finished product families of the Assembly was selected at a time, and value streams of its finished parts that are going to be assembled were reviewed with the model. As each of the selected final product families could have 100 different value streams in the case company, it was decided to apply the optimization model only for those value streams that end with finished parts that were consistently in shortage report during last year in order to limit samples. Value streams of these pacer parts vary. Some of them could have only the supplier stage before the assembly

and some others could be very long. As discussed before, these long value streams were limited by taking into account only parts of level 1 and 2 of its finished product’s bill of materials (BOM).

V. COMPUTATIONAL RESULTS

Results of the model applied to some value stream samples of one finished product family in the company are presented in Table III. This table includes input factors to the model such as delivery performances (P_i, P_p), parts quantities (q_i, q_p), costs (C_s, C_o) along with parameters required to calculate them (K'_i, P'_p, K'_p , standard cost) for each value stream. This table also presents the old and new safety stock levels and total costs to compare previous situation with new one. All historical data presented in this table, as mentioned before in “Model Formulation” section, are based on last year records. In addition, recommendations of the model based on the analysis of the real cases are explained. It should be mentioned that due to confidentiality, masked data are used in this paper.

Value Stream 1:

Shortage costs of ASSY and AFM (customers) are the first two highest costs; therefore, the model has targeted them at first and recommended that the delivery performances in those entities be increased to 100% by keeping safety stock for the finished parts. ASSY and AFM can count on receiving their required demand on time for 0.61% and 0.30% respectively; thus, they need to compensate the 0.39% and 0.70 % of *unavailability* of parts by asking manufacturing to keep safety stock. Then, the third and fourth highest costs are the average costs of the same entities. Hence, the model suggests keeping some level of safety stock in the raw material (semi-finished part) level as well to lower the level of finished parts’ safety stocks. It is shown that procurement can count on on-time delivery performance of supplier(s) for 0.57% and they have to reimburse the remaining 0.43% by having safety stock. As in this case, safety stock has been increased in both levels of supplier and manufacturing, of course before applying the recommendations, the capacity of both should be checked in order to be aligned with the new level of demand and input respectively.

Value Stream 2:

According to the priority of the costs, shortage should be removed for the Assembly entity by keeping safety stock for its required finished part. In this case, the manufacturing performance is zero; therefore, having safety stock for the raw materials’ level in case of improving the input ration to this entity will not make any changes. Consequently, there is no choice but to pay for the holding cost for the finished part, although this holding cost is the second highest cost. On the other hand, as soon as manufacturing performance increases even slightly, the level of safety stock required for the finished part will decrease by recommending holding some safety stock for raw materials.

Value Stream 3:

In this case, the highest cost is related to the shortage of finished part required for Aftermarket; hence, safety stock should be kept for this customer. Then, the biggest loss would happen if the company cannot deliver the required demand of ASSY; As manufacturing's performance in response to Assembly's demand is 100% and it can produce whatever it receives from procurement, delivery performance to ASSY will be improved only by increasing input of the raw material to manufacturing. To make a decision about the value of K_i , the model will hit the third highest cost which is the raw material's shortage cost.

and 7 present the respective value stream and BOM.

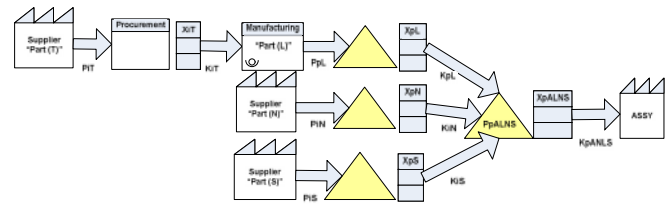

TABLE III COMPUTATIONAL 6 Value Stream

Value Stream	Part Code	Entity	K'_i	P_i	q_i	P'_p	P_p	q_p	K'_p	Std. Cost	C_s	C_o	Old x_i	New x_i	Old x_p	New x_p	Total Old Cost	Total New Cost
VS1	B	MF	0.65	0.57	1400					\$40	\$2	\$4	0&500	602			\$497,732	\$15,116
VS1	AB	ASSY				0.40	0.61	1100	0.53	\$120	\$500	\$12			1&8	429		
VS1	AB	AFM				0.20	0.30	900	0.46	\$120	\$480	\$12			300	630		
VS2	C	MF	0.22	0.22	5					\$2000	\$25	\$200	0	0			\$28,257	\$10,757
VS2	D	MF	0.24	0.24	7					\$8000	\$30	\$800	0	0				
VS2	ACD	ASSY				0	0	7	0	\$15000	\$4000	\$1500			1&2	7		
VS3	F	MF	0.58	0.37	25					\$500	\$150	\$50	5&9	16			\$4,457.5	\$913
VS3	AF	ASSY				0.59	1	12	0.58	\$1000	\$450	\$100			0	0		
VS3	AF	AFM				0.48	0.82	7	1	\$1000	\$4000	\$100			24	2		
VS4	T	MF	0.70	0.59	25					\$200	\$15	\$20	6	10			\$1,249	\$468.96
VS4	L	MF				0.30	0.43	12	0.50	\$300	\$25	\$30			4&3	7		
VS4	N	MF	0.70	0.53	12					\$90	\$2	\$9	14&0&5	6				
VS4	S	MF	0.95	0.95	10					\$160	\$8	\$16	0	1				
VS4	ALNS	ASSY				0.59	1	5	0.85	\$3500	\$200	\$350			6&3	0		

The selected value for K_i will also affect the level of required safety stock for Aftermarket.

Value Stream 4:

This sample shows one of the class A finished parts required for Assembly for the selected product family. This finished part has three semi-finished parts (level 2 in finished product's BOM which are L, N, and S in Table III). "L" is an in-house part and is manufactured in ABC. Furthermore, the manufacturing plant requires raw material (T) to produce this part which is procured through the supplier. Part T is in level 3 in the BOM. Therefore, this sample goes far beyond the limitation of levels 1 and 2, and shows that the model is applicable for all stages of the value streams as long as the input data of the model are provided. Manufacturing, receives the two other semi-finished parts (N and S) required for producing the finished part directly through suppliers. Fig. 6

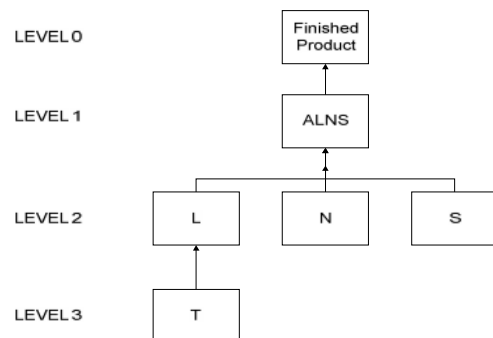

Fig. 7 BOM

This last value stream (value stream 4), can be a representative case to illustrate the error and especially in this case, the overestimating of safety stock result in the analysis of

parts in isolation and not within the chain. If, ALNS was being considered separately and apart of its chain, system may allocate some level of safety stock for that due to the K'_p which is 85%. But, when this part is analyzed within its chain, it is understood that the reason for no availability of the finished part is not due to the last stage performance but it is due to the low delivery performances of the semi-finished parts. Therefore, keeping safety stock in the last stage only increases the holding cost of the system.

VI. VALIDATION

In this section, historical data on a raw material part will be used for analysis and compared to the results of the model. As illustrated in Fig. 8, there were periods in the last 5 months during which the company was in shortage and had negative stock and during that period there was no safety stock assigned to this part. On the other hand, the stock situation became better starting in week 14 by allocating 600 units of safety stock. Thus the theoretical safety stock was 0 and 600 for this part during the last five months. The same analysis for part availability percentage through supplier for procurement (P_i) and also the delivery performance of procurement including their safety stock to manufacturing (K'_i) are also analyzed for the same period, as shown in Fig. 9 and 10.

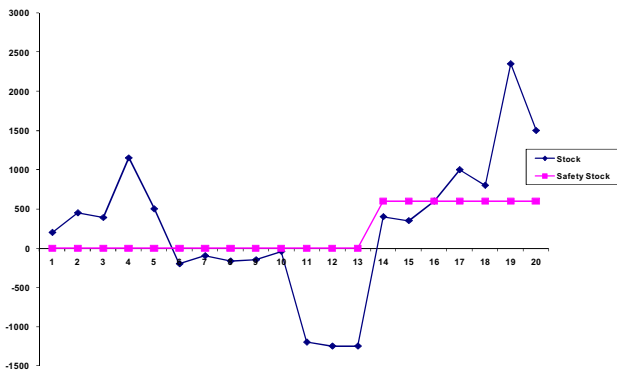

Fig. 8 Past Stock Situation and Safety Stock Level

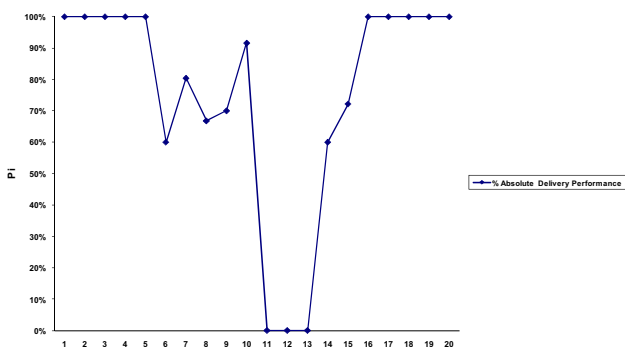

Fig. 9 Absolute Part Availability Percentage without Safety Stock

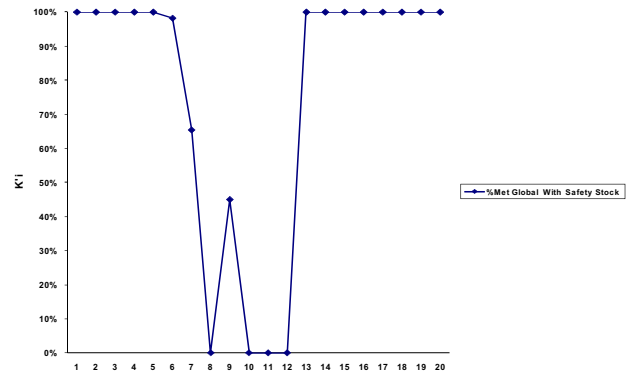

Fig. 10 Procurement Delivery Performance with Safety Stock

It can be seen that the weakness of part availability in weeks 13, 14, and 15 had been compensated by safety stock; although this weakness could not be remunerated previously as there was no safety stock. Therefore, it is concluded that by this amount of availability for this part, safety stock is essential to guarantee on-time delivery to manufacturing.

The optimization model was then run for the raw material's value stream. The result of the model was 394 pieces for the raw material's safety stock; but of course this level is based on the next quarter ratio of demand. Indeed, the lower level of safety stock recommended through the model is related to the maximum quantity of this part that will be required in the next three months based on the forecast. And this maximum number is being considered in the model to decide the level of safety stock to guarantee the worst case. On the other hand, it is shown through Fig. 8 that by keeping 600 pieces of safety stock, the level of stock is going to be increased and this is not a desired case as holding cost is associated with this increase; therefore, lowering the level of safety stock does make sense.

Fig. 11 and 12 show the historical data of three factors, FFR (%), safety stock fulfill rate (SS FR%), and number of parts with quality issues (QN in pieces) for three different parts. The messages of these charts are provided as well. These messages were aligned with the safety stock model's results obtained for the respective parts.

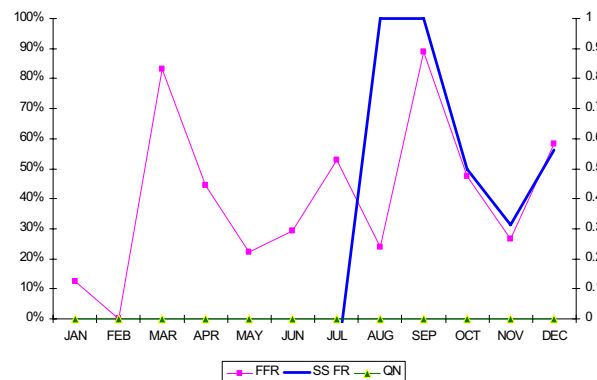

Fig. 11 FFR, SS FR, QN

*There is no quality issue.

*Buffer strategy is required to compensate the low delivery performance.

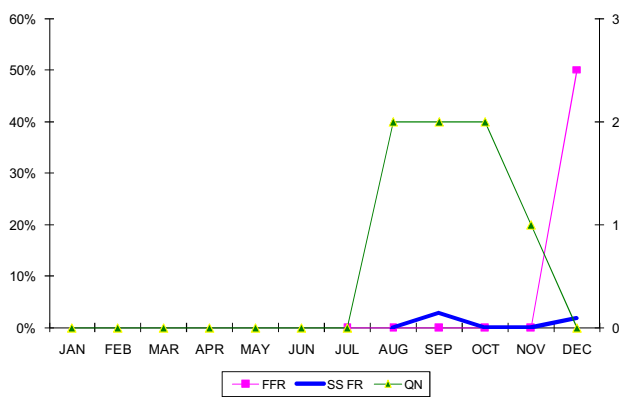

Fig. 12 FFR, SS FR, QN

* Low FFR can be improved by 50% if quality issues solved.

*Additional buffer may be required to increase FFR by 50% and make it 100%.

VII. DISCUSSION AND IMPLICATIONS

The recommendations of the model are according to the current situation of the system. Of course as soon as the company takes action towards improving its system for parts availability within the chain, the results of the model for level and location of required safety stock will be adjusted accordingly. Re-sourcing of the suppliers would be a solution for their low delivery performances and quality problems. Increasing the capacity of manufacturing and improving its quality would be a solution for low availability percentage at semi-finished and finished parts level. On the other hand, in the cases that the company requires keeping some level of safety stock due to the bad performance of vendors (low delivery performance, low quality), it is recommended that a VMI (Vendor Managed Inventory) system be applied to have safety stock at the vendors' place. Existed FFR report in the case company for Aftermarket entity is based on their forecast demand instead of their firmed orders; therefore, the model is not capturing the accurate delivery performance record for them. For solving this problem, it is recommended to design a FFR report specifically for Aftermarket in order to capture the performances in respond to only firmed orders. There may be some parts that are dual sourced and there is a quota arrangement between different suppliers, but the FFR report being used in the case company does not include the vendor field in its results. Therefore, it is recommended that the supplier field in the FFR report be considered as well to allow the company to recognize their delivery performances separately and consequently be able to make decision about re-sourcing more accurately. For some cases where unavailability of a part is solely related to the low delivery performances and not to quality issues, safety lead time can be applied instead of safety stock. Delivery performances of some parts in their last stage are very low due to different engineering issues such as changing the layout and design consistently. Therefore, recommendation of the model to have safety stock for these parts will make sense only if the cost of reverse engineering of these parts is less than their shortage cost. If the model

suggests increasing the level of safety stock for a specific stage, the company will receive it by the end of the *total lead time* of the chain related to that part. Therefore, if the company adds the extra pieces of safety stock to its demand, it will allow all purchase orders to be expedited although this extra amount is not the actual demand and it is required for safety stock. Hence, the company must inform the suppliers that it needs this portion of demand for their next lead time. On the other hand, it is really important to take into account the lead time of the whole chain, otherwise, it will put them in a shortage situation. As a result, knowing the existence of this time lag by adding the required safety stock to the company's demand until receiving it through the chain, the period for calculating q_i and q_p can be selected more accurately. The q_i for those parts that are strategic ones should be validated with the responsible value stream managers. Indeed, quantities of this kind of parts could be really greater than the number which is result in through the mentioned definition for them. There are different indicators that make a part strategic such as the critical parts that are single sourced, or the parts that have limited suppliers or the parts with the resourcing strategy. For example, there could be a single sourced critical part which is received in a batch and based on the experience it is known that if one part of this batch has a quality issue, there is a high possibility that the entire batch needs to be scrapped.

VIII. CONCLUSIONS

This paper applies an optimization safety stock model based on cost minimization objective to a practical real-world problem. Lingo 11.0 was used to solve the linear and non-linear optimization model. The weakness of the supply chain must be compensated with safety stock, while it is optimized to meet the desired objective of the business. It has been shown in this paper that in optimizing the safety stock based on a cost minimization objective, not only its level but also its location in the supply chain is important. Accurate definitions of the inputs of the model such as shortage and overage costs and also quantities of the parts are critical to find the appropriate level and location of safety stock. Through this procedure, the company can improve its profitability and also become a superior competitor with its chain. If a part is procured through more than one supplier, the current model tracks their performance with only one average number representative of all of them. In future work, the model may be extended simultaneously by increasing the accessibility of the other required input data to decide on the level of safety stock for each of these suppliers separately. Due to the inaccessibility of the required data, the model is currently limited to the last two stages before the customer in the chain. Again, by enhancing the visibility and control of the upstream stages in the chain, the model can be applied for each specific part from its starting point until the end of the chain. Furthermore, by increasing the accessibility of the data, the cost of shortage of raw material/semi-finished part can be more accurate by adding the re-sequencing cost of manufacturing. In order to

have a high level view of safety stock kept across the chain, this model can be applied to the aggregate level of stages and entities involved in the chain instead of applying it to the part level. Indeed, q_i and q_p will be the total demand of the downstream stage in a specific period seen by its upstream stage (kits of parts instead of one part) and delivery performances will be delivery performance of each stage to its downstream stage in respond to its whole demand. The parts that were historically pacers with the maximum number of shortages within the total demand of each stage will be selected as the representatives for calculating the shortage and overage costs of the stages for determining the location of safety stock.

REFERENCES

- [1] David Taylor, "Parallel incremental transformation strategy: An Approach to the Development of Lean Supply Chains", *International Journal of Logistics Research and Applications*, Vol.2, No.3, 1999, pp. 305-323.
- [2] R. Mason-Jones, B. Naylor, D. R. Towill, "Lean, agile or leagile? Matching your supply chain to the marketplace", *International Journal of Production Research*, Vol.38, No.17, 2000, pp. 4061-4070.
- [3] J. Ben Naylor, M. M. Naim, D. Berry, "Leagility: Integrating the lean and agile manufacturing paradigms in the total supply chain", *International Journal of Production Economics*, Vol.62, 1999, pp. 107-118.
- [4] A. Agarwal, R. Shankar, M. K. Tiwari, "Modeling the metrics of lean, agile, and leagile supply chain: An ANP-based approach", *European Journal of Operational Research*, Vol.173, 2006, pp. 211-225.
- [5] F. Qi, X. Xuejun, G. Zhiyang, "Research on Lean, Agile and Leagile supply chain", Partially supported by National Natural Science Foundation of China Grand and IOM European "Asia-Link Programme", 2007, pp. 4902-4905.
- [6] Y. Chun Wu, "Lean manufacturing: a perspective of lean suppliers", *International Journal of Operations & Production Management*, Vol.23, No.11, 2003, pp. 1349-1376.
- [7] S. Wu, H. M. Wee, "How Lean supply chain effects product cost and quality- A case study of the Ford Motor Company", 6th International Conference on Service Systems and Service Management, 2009, pp. 236-241.
- [8] S. T. Crino, D. J. McCarthy, J. D. Carier, "Lean Six Sigma for supply chain management as applied to the Army Rapid Fielding Initiative", 1st Annual IEEE Systems Conference, April 2007, pp. 1-7.
- [9] E. D. Adamides, N. Karacapilidis, H. Pylarinou, D. Koumanakos, "Supporting collaboration in the development and management of lean supply networks", *Production Planning & Control*, Vol. 19, No.1, January 2008, pp. 35-52.
- [10] Y. Kainuma, N. Tawara, "A multiple attribute utility theory approach to lean and green supply chain management", *International Journal of Production Economics*, Vol.101, 2006, pp. 99-108.
- [11] Richard Lamming, "Squaring lean supply with supply chain management", *International Journal of Operations & Production Management*, Vol.16, No.2, 1996, pp. 183-196.
- [12] P. McCullen, D. Towill, "Achieving lean supply through agile manufacturing", *Integrated Manufacturing Systems*, 2001, pp. 524-533.
- [13] Hongmai Wu, "The Lean manufacture research in environment of the supply chain of modern industry engineering", 16th Conference on Industrial Engineering and Engineering Management, 2009, pp. 297-300.
- [14] R. Cagliano, F. Caniato, G. Spina, "Lean, Agile and traditional supply: how do they impact manufacturing performance?", *Journal of Purchasing & Supply Management*, Vol.10, 2004, pp. 151-164.
- [15] L. O. Aleotti Maia, R. Y. Qassim, "Minimum cost safety stocks for frequent delivery manufacturing", *International Journal of Production Economics*, October 1998, pp. 233-236.
- [16] R. "Nat" Natarajan, S. K. Goyal, "Safety stocks in JIT environments", *International Journal of Operations & Production Management*, Vol. 14, No.10, 1994, pp. 64-71.
- [17] Stefan Minner, "Dynamic programming algorithms for multi-stage safety stock optimization", *OR Spektrum*, Vol.19, No.4, 1997, pp. 261-271.
- [18] A. P. Kanyalkar, G. K. Adil, "Determining the optimum safety stock under rolling schedules for capacitated multi-item production systems", *International Journal of Services and Operations Management*, Vol. 5, No.4, 2009, pp. 498-519.
- [19] J. Y. Jung, G. Blau, J. F. Pekny, G. V. Reklaitis, D. Eversdyk, "Integrated safety stock management for multi-stage supply chains under production capacity constraints", *Computers and Chemical Engineering*, Vol.32, 2008, pp. 2570-2581.
- [20] Q. y. Li, S. J. Li, "A dynamic model of the safety stock under VMI", *Proceedings of the Eighth International Conference on Machine Learning and Cybernetics*, July 2009, pp. 1304-1308.
- [21] L. Ma, M. Lin, "Determination of safety stock for power enterprises under uncertainty", *International Symposium on Computer Science and Computational Technology*, 2008, pp. 92-94.
- [22] R. Patel, L. L. R. Rodrigues, "Optimizing safety stock in manufacturing supply chain management: A system dynamics approach", 12th International Conference on Computer Modelling and Simulation, 2010, pp. 386-391.
- [23] X. Zhao, F. Lai, T. S. Lee, "Evaluation of safety stock methods in multilevel material requirements planning (MRP) systems", *Production Planning & Control*, Vol. 12, No.8, 2001, pp. 794-803.
- [24] R. D. Badinelli, "Optimal safety-stock investment through subjective evaluation of stockout costs", *Decision Sciences*, Vol. 17, 1986, pp. 312-328.
- [25] B. Desmet, E-H Aghezzaf, H. Vanmaele, "A normal approximation for safety stock optimization in a two-echelon distribution system", *Journal of the Operational Research Society*, Vol.61, No.1, 2010, pp. 156-163.
- [26] K. Inderfurth, "Safety stock optimization in multi-stage inventory systems", *International Journal of Production Economics*, Vol.24, 1991, pp. 103-113.
- [27] K. Inderfurth, "Multistage safety stock planning with item demands correlated across products and through time", *Production and Operations Management*, Vol. 4, No.2, 1995, pp. 127-144.
- [28] E. A. Silver, D. F. Pyke, R. Peterson, "Inventory management and production planning and scheduling (Book style)", 3rd ed., 1998, pp. 241-247.
- [29] Q. Long, L. F. Liu, L. Q. Meng, W. Chen, "Logistics cost optimized election in the manufacturing process based on ELECTURE- II Algorithm", *Proceedings of the IEEE International Conference on Automation and Logistics*, August 2009, pp. 2055-2059.
- [30] J. Paul Dittman, R. Slone, John T. Mentzer, "Supply chain risk: It's time to measure it [Online]", February 2010, Available: http://blogs.hbr.org/cs/2010/02/is_your_supply_chain_at_risk_1.html
- [31] John J.Coyle, Edward J.Bardi, C.John Langley, "Supply chain management: a logistics perspective (Book style)", 2009, Chapter 8, pp. 297.
- [32] "The importance of the supply chain [Online]", supply initiative, meeting the need for reproductive health supplies, pp. 1-2, Available: http://www.rhsupplies.org/fileadmin/user_upload/toolkit/D_Advocacy_Tools/Fact_Sheets/facsheet_4_pdf.pdf
- [33] T. Jonathan, S. E. Omosigho, "Multi-stage manufacturing system-research issues and challenges [Online]", 2003, pp. 1-33, Available: <http://www.hicstatistics.org/2003statsproceedings/Jonathan%20Tsetimi.pdf>
- [34] S. C. Graves, A. H. G. Rinnooy Kan, P. H. Zipkin, "Logistics of production and inventory (Book style)", *Handbooks in Operations Research and Management Science*, Vol.4, Chapter.1, 1993, pp.33.