

Water Vapour Transmission through Weather Resistive Barriers

Tania Mungo

A Thesis in the department of Building, Civil and Environmental Engineering

Presented in Partial Fulfillment of the Requirements
for the Degree of **Master of Applied Science (Building Engineering)** at
Concordia University
Montreal, Quebec

May, 2003

© Tania Mungo, 2003.



Library and
Archives Canada

Bibliothèque et
Archives Canada

Published Heritage
Branch

Direction du
Patrimoine de l'édition

395 Wellington Street
Ottawa ON K1A 0N4
Canada

395, rue Wellington
Ottawa ON K1A 0N4
Canada

Your file *Votre référence*

ISBN: 0-494-10223-3

Our file *Notre référence*

ISBN: 0-494-10223-3

NOTICE:

The author has granted a non-exclusive license allowing Library and Archives Canada to reproduce, publish, archive, preserve, conserve, communicate to the public by telecommunication or on the Internet, loan, distribute and sell theses worldwide, for commercial or non-commercial purposes, in microform, paper, electronic and/or any other formats.

The author retains copyright ownership and moral rights in this thesis. Neither the thesis nor substantial extracts from it may be printed or otherwise reproduced without the author's permission.

AVIS:

L'auteur a accordé une licence non exclusive permettant à la Bibliothèque et Archives Canada de reproduire, publier, archiver, sauvegarder, conserver, transmettre au public par télécommunication ou par l'Internet, prêter, distribuer et vendre des thèses partout dans le monde, à des fins commerciales ou autres, sur support microforme, papier, électronique et/ou autres formats.

L'auteur conserve la propriété du droit d'auteur et des droits moraux qui protègent cette thèse. Ni la thèse ni des extraits substantiels de celle-ci ne doivent être imprimés ou autrement reproduits sans son autorisation.

In compliance with the Canadian Privacy Act some supporting forms may have been removed from this thesis.

Conformément à la loi canadienne sur la protection de la vie privée, quelques formulaires secondaires ont été enlevés de cette thèse.

While these forms may be included in the document page count, their removal does not represent any loss of content from the thesis.

Bien que ces formulaires aient inclus dans la pagination, il n'y aura aucun contenu manquant.

Canada

Abstract

Water vapour transmission through weather resistive barriers

Tania Mungo

The necessity to understand and test water vapour transfer through wall systems has been recognized for over 70 years. Yet, while many aspects have been investigated and many different test methods have been used to determine permeability of materials there are many unanswered questions. This thesis work examines the applicability of steady state test methods in determining water vapour transmission through weather-resistive barriers (WRB). Presently there are different standards for North America, Europe, and Scandinavia, which are implemented for water vapour transmission testing. The test methods require many complex systems in order to be performed. The focus of this work is on determining a simplified and easy to perform test, enabling tests to be performed outside of a laboratory environment.

The scope of this work evaluates two proposed test methods in this field of study. Both are used for measuring water vapour transmission through weather resistive membranes, and both are recently developed test methods. Four types of WRB are evaluated, namely two asphalt impregnated cellulose fibres and two polymeric fibres membranes.

This thesis takes an in depth look at the significance of factors affecting precision of the test e.g., surface and the still air layer resistance.

It is found that temperature control is a factor of great significance. This research also concludes that contrary to recent documentation, surface resistance is material dependent when evaluating these types of test methods.

Acknowledgments

My deepest thanks and sincere appreciation goes to my supervisors, Professor Fariborz Haghighat and Professor Mark Bomberg, for their continual aid and contributions in the creation of this thesis.

My sincere thanks to the sponsors of this work: Canada mortgage and housing corporation (CMHC), Du Pont Inc., Fortifiber Corporation, Hal Industries, Homeowner protection office (A provincial crown corporation serving British Columbia). As well as DMO Associates, and Louisiana Pacific corporations.

My gratitude to the members of the Steering committee of the consortium on External Moisture Control (EMC), including Fred Baker, Sylvio Plescia, Theresa Weston, and Golnar Riahi for their greatly appreciated input and contributions.

Special thanks to Mr. Joseph Hrib and Mr. Joseph Zilhka for their aid in building the equipment needed for the tests performed for this work. Thanks to Mr. Ron Parisella, Mr. Jacques Payer, Ms. Dorina Bannu, and Mr. Luc Demers for their often sought services. Thanks to my laboratory co-researchers for their assistance in the laboratory, Marcin Pazera, Yu Huang, and Jian Zhang.

Deepest gratitude to my parents, for their unconditional love and support, as well as to my brother Mark, sister Melissa, and brother in law Eric.

Table of Contents

	page
List of figures.....	vii
List of tables.....	ix
List of symbols.....	xii
1. Introduction.....	1
1.1. Background.....	1
1.2. Objective and scope of this research.....	5
1.3. Contributions.....	7
2. Literature review.....	8
2.1 Introduction to water vapour transmission.....	8
2.1.1. Diffusion coefficient.....	8
2.1.2. Phenomenons of water vapour transmission.....	10
2.1.3. Test methods.....	13
2.2. Errors in testing.....	37
2.2.1. Introduction.....	37
2.2.2. Apparatus design.....	37
2.2.3. Specimen sealing.....	38
2.2.4. Masked edge effect.....	38
2.2.5. Test chamber conditions.....	40
2.2.6. Cup conditions.....	43
2.2.7. Air space.....	43
2.2.8. Determination of steady state.....	46
2.2.9. Barometric pressure effects.....	47
2.2.10. Frequency of data collection.....	49
3. Test methods.....	50
3.1 Double cup test method.....	50
3.1.1 Ruggedness study for double cup method.....	53
3.1.2 Results and analysis.....	55
3.2 Modified inverted cup method.....	59
3.2.1 Ruggedness study for modified inverted cup method.....	60

3.2.2	Results and analysis.....	62
4.	Corrections for surface resistance and still air layer.....	64
4.1	Calculations.....	64
4.2	Double cup (DC) test method applied to type P products.....	64
4.3	Modified inverted cup (MIC) test method applied to type P products.....	66
4.4	Double cup (DC) test method applied to type C products.....	66
4.5	Modified inverted cup (MIC) test method applied to type C products.....	67
4.6	Discussion on intercepts obtained from different WVT tests on various products.....	67
5.	Results of the WVP measurements and discussion.....	73
5.1.	Type P products.....	73
5.2.	Type C products.....	75
6.	Conclusions.....	77
6.1	Future research.....	79
	References.....	80
	Appendices.....	83
A.1.1.	Double cup test data.....	83
A.1.2.	Modified inverted cup test data.....	161
A.2.1.	Photographs.....	210

List of Figures

Figure 1.1:	Magnification photo of a Class C, Cellulose-impregnated cellulose fibre based WRB rated 60 minutes. Provided by the External Moisture Consortium.....	4
Figure 1.2:	Magnification photo of a Class P, Polymeric fibrous WRB. Provided by the External Moisture Consortium.....	4
Figure 2.1.	Cell used for thick samples. Babbitt (1939).....	15
Figure 2.2.	Cell used for samples up to 1 inch thick. Babbitt (1939).....	15
Figure 2.3.	Testing apparatus for several dish types. ASTM E-96-00.....	16
Figure 2.4.	Spot permeability curve by Joy and Wilson (1965).....	18
Figure 2.5:	Test apperatus, Nordtest method, Materials, thin: Water vapour permeability.....	21
Figure 2.6:	Resistance to water vapour flow, nordtest method, Materials, thin: Water vapour permeability (1984).....	22
Figure 2.7:	Inverted cup method, Thorsen, Symposium on building physics in the Nordic countries, (1987).....	23
Figure 2.8:	Modified cup test method, Schwatz et al. (1989).....	26
Figure 2.9:	Nordtest method, NT BUILD 130 :Example of test cups (1990).....	30
Figure 2.10:	Masked edge effects for 5 inch diameter test area, Joy and Wilson (1965).....	39
Figure 2.11:	R.H. distribution across a painted gypsum board specimen. Burch and Thomas (1992).....	43
Figure 2.12:	W.L. Wilkins and M.R. Pullan (1988).....	48
Figure 3.1:	Double cup test apparatus.....	50
Figure 3.2:	Double cup test ring set-up.....	51
Figure 3.3:	Modified inverted cup test apparatus.....	59

List of Tables

	page
Table 3.1: General ruggedness study set-up.....	54
Table 3.2: Ruggedness study set-up for double cup test method.....	54
Table 3.3: Ruggedness study for DC method desiccant side.....	56
Table 3.4: Ruggedness study for DC method solution side.....	57
Table 3.5: Ruggedness study for DC method comparison of solution & desiccant sides	57
Table 3.6: Ruggedness study set-up for modified inverted cup test method.....	60
Table 3.7: Ruggedness study set-up for modified inverted cup test method.....	62
Table 4.1: Intercept values obtained with different DC tests performed on products P6 and P8.....	65
Table 4.2: Intercepts for the tested materials using the MIC test method.....	66
Table 4.3: Intercepts determined for products C4 and C5.....	66
Table 4.4: The mean values (from both desiccant and solution sides) measured with the DC method and the desiccant side values for the MIC method.....	67
Table 4.5 Intercept data obtained by Burch and Thomas (1992).....	69
Table 4.6 Intercept data obtained from different sources for 25-mm thick air layer.....	70
Table 4.7 Surface resistance calculated from the total intercept values.....	70
Table 5.1: Resistance to water vapour flow measured on single layer of type P products with corrections from individual measured intercepts as well as corrections from mean intercept value, all values in Pa·s·m ² /kg.....	73
Table 5.2: Water vapour permeance as measured for materials P (apparent) and that based on intercept correction in metric and British systems (perms).....	74

Table 5.3 Resistance to water vapour flow measured on single layer of type C product with corrections from individual measured intercepts as well as corrections from mean intercept value, all values in Pa·s·m²/kg.....75

Table 5.4 Water vapour permeance as measured (apparent) and that based on intercept correction in metric and British systems(perms).....75

Figure 4.1:	Intercept values for P8 product obtained with the DC method.....	65
Figure 4.2:	Intercept mean of materials C5, P6, and P8 measured with both DC and MIC methods.....	68
Figure A2.1.	DC Test set-up.....	210
Figure A2.2.	Test apparatus disassembled.....	210
Figure A2.3.	Dry cup assembly.....	211
Figure A2.4.	MIC Test set-up, without water on surface.....	211
Figure A2.5.	MIC test set-up disassembled without water on surface.....	212

List of Symbols

<i>A</i>	Area of the cross sectional flow path	m^2
<i>G</i>	weight change	kg
<i>g</i>	density of moisture flow rate	$kg/(m^2 \cdot s)$
<i>K</i>	water permeability coefficient	$(kg/Pa \cdot m \cdot s)$
<i>k_d</i>	is the vapour permeability coefficient	$kg/Pa \cdot m \cdot s$
<i>L</i>	thickness of the specimen	m
<i>m</i>	mass	kg
<i>P</i>	ambient pressure	Pa
<i>P₀</i>	standard atmospheric pressure	101325 Pa
<i>p</i>	Relative humidity	%
<i>q</i>	equilibrium flux of water vapour through a unit area	$kg/s \cdot m^2$
<i>R_v</i>	ideal gas constant for water	$461.5 J \cdot K^{-1} \cdot kg^{-1}$
<i>S</i>	saturation vapour pressure at test temperature in	Pa
<i>t</i>	time	s
<i>T</i>	temperature of the test chamber	° K
<i>v</i>	Content of vapour in air	kg/m^3
<i>V</i>	volume of the specimen	m^3
<i>W</i>	weight	g
<i>W_p</i>	Permeance	$kg/(m^2 \cdot s \cdot Pa)$
<i>WVT</i>	rate of water vapour transmission,	$kg/s \cdot m^2$
<i>Z</i>	water vapour diffusion resistance	s/m
<i>Z_m</i>	water vapour resistance	$Pa \cdot m^2 \cdot s/kg$

Z_p	resistance of the material itself	$\text{Pa}\cdot\text{m}^2\cdot\text{s}/\text{kg}$
Z_1, Z_2	resistance at the specimen surfaces	$\text{Pa}\cdot\text{m}^2\cdot\text{s}/\text{kg}$
Z_a	resistance of the air layer within the cup	$\text{Pa}\cdot\text{m}^2\cdot\text{s}/\text{kg}$
Δp	vapour pressure difference in	Pa
δ_L	moisture permeability in the air	$\text{kg}/(\text{m}\cdot\text{s}\cdot\text{Pa})$
δ	water vapour permeability	$\text{kg}/(\text{m}\cdot\text{s}\cdot\text{Pa})$
δ_a	permeability of still air	$\text{kg}/(\text{m}\cdot\text{s}\cdot\text{Pa})$
ρ_a	density of air	kg m^{-3}

Chapter 1: Introduction

1.1 Background

Wall design is an important factor in the design of buildings today, most wall design depends on climate and in some cases availability of the desired materials. Climate has proven to have a substantial effect on wall design, as well as the cost of construction. Historically shelters were needed for human survival simply for protection from weather; originally this often was accomplished by living in caves. As time progressed humans began to find alternative measures for shelter such as huts, later developing to log homes then wood framed shelters, and eventually to stone shelters. By creating shelter that could be constructed where desired cities were born, and as the world evolved so did construction methods. Once house construction improved and basic wood frame houses were being built, the standard of life increased. In North America in the late 1940's living standards were higher than they had ever been, most homes consisted of wood frame construction and mechanical heating was present in many homes in the cold regions. The first documentation of the sheathing membrane or weather-resistive barrier (WRB) which at the time was referred to as building paper was based on research conducted at the University of Minnesota, it focused on air leakage through walls. In 1940 water vapour diffusion through building materials was being researched by J.D. Babbitt and also by Rowely and aided in properly understanding the properties of wall systems. Vapour barriers had been recently introduced as well as weather resistive barriers, originally WRB's were created by using Kraft paper and not long after evolved to cellulose fibre, which was asphalt impregnated paper, similar to that of roofing paper. Over time the need for more insulation within walls became apparent, the increased

amounts of insulation decreased heat loss. However, condensation began to occur within the insulation resulting in ice problems thus increasing heat loss, structural issues and in some cases causing mould growth. Condensation also proved to affect the water vapour transmission rate of the material and decreasing their performance significantly. To rectify the situation WRBs as well as vapour barriers were implemented in order to limit the amount of moisture entering the system while allowing trapped moisture to exit the wall. Further research was conducted by multiple scientists, all were in agreement that the placement of the vapour barrier was a key factor in controlling condensation within a wall, and concluded that the vapour barrier must be placed on the warm side of the wall, with a WRB located on the exterior portion of the wall.

By the 1950's the need for WRBs in wall systems was addressed by the National Building Code of Canada, WRBs with a permeance of less than 1 perm was required in all new homes.

In the 1960's electric baseboard heating became the new heating trend due to it reducing the need for combustion fuel and solving the problem of heat distribution through the home. This resulted in an increased demand for wall efficiency became higher due the significantly higher cost of electrical heating.

The oil crisis of the late 1970's and fear of its re-occurrence induced greater attention to heat loss through wall systems. Eventually a program called R-2000 homes was developed, it focused on highly efficient wall systems that significantly reduced heat loss while considering indoor air quality of the home. This program did raise awareness of the environmental (heat, air and moisture) control of wall systems and aided in

informing the general public of its importance relative to health, energy efficiency, and cost.

The necessity to control water and vapour flows through wall systems has become well established as of late. Yet, the focus was always on vapour barriers (VB) and little attention was paid to the other side of the wall, i.e., control of water vapour flow through the WRB. Therefore, this thesis will review the existing test methods and if needed, develop new testing methods for determination of water vapour transmission through WRB products.

Recently the External Moisture Consortium has begun developing a new classification in order to accommodate the large range of existing WRB products. This system aids in organizing the materials and consists of five types of materials, asphalt impregnated cellulose fibre, polymeric fibre, perforated polymeric film, liquid applied, and micro porous films. All current types of WRBs fall under into one of these categories.

Two WRB types will be considered in this research class C & P. Class C is asphalt impregnated cellulose, (Figure 1.1), which consists of Asphalt saturated Kraft paper. Class P is polymeric fibre (Figure 1.2), which consists of spun bounded olefin sheets of high density polyethylene fibres, the sheets are formed by spinning continuous strands of fine interconnected fibres, and are bonded together through a heat and pressure process. In turn, these two categories consist of materials, which can be considered either as barriers or breathers.

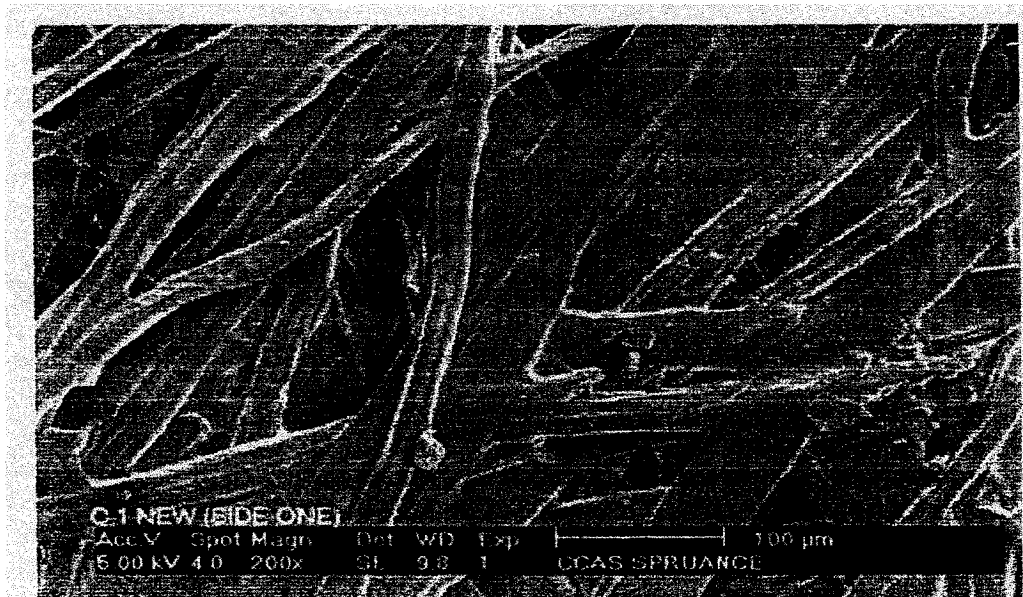

Figure 1.1: Magnified image of a type C, Asphalt-impregnated cellulose fibre based WRB rated 60 minutes. Provided by the External Moisture Consortium.

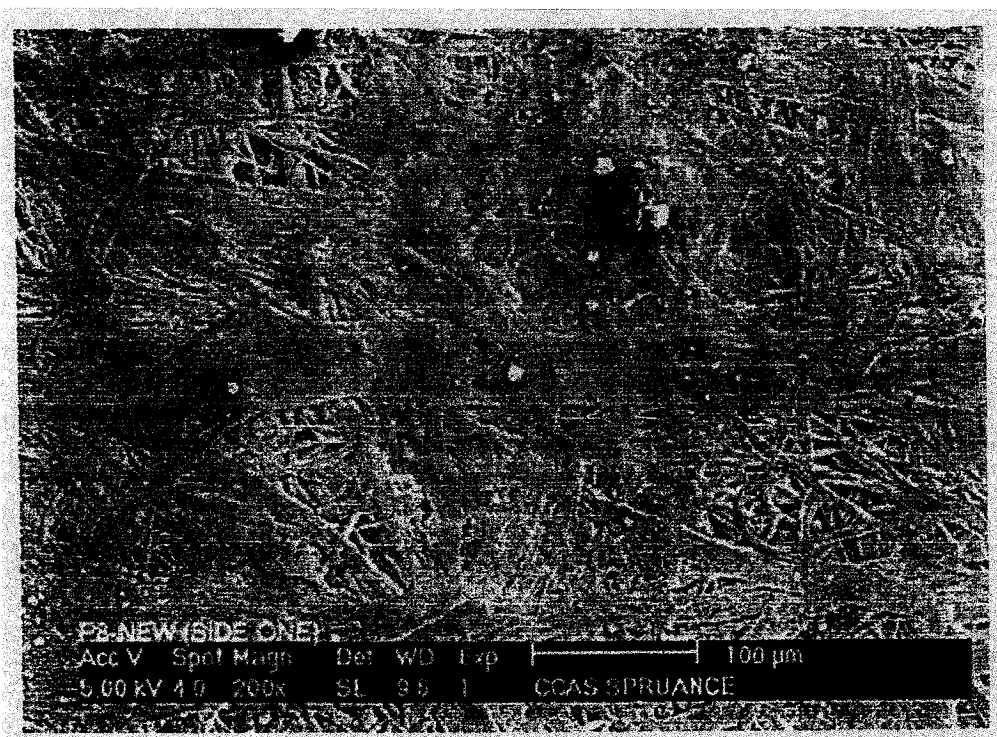

Figure 1.2: Magnified image of a Type P, Polymeric fibrous WRB. Provided by the External Moisture Consortium.

Climate plays a pivotal role in wall design, a vapour barrier or an air barrier may be required to be in different locations within a wall depending on climatic conditions.

Yet, there is an inherent contradiction in the requirements for WRBs in cold climates, namely a WRB should allow interior water vapour to exit the structure while resisting water and water vapour from the exterior to enter the wall system. To address this contradiction we must be able to formulate requirements as they vary depending on the climate as well as to perform precise measurements of water vapour transmission.

1.2 Objective and scope of this research

This research is aimed at determining which test methods are most appropriate for determining water vapour transmission through the breather type materials. Most of the research had been focused on water vapour retarders, there is a need to determine which test methods are most appropriate for breather type materials. It is important to determine which tests are most accurate as well as which tests are more reproducible without affecting the integrity of the test results. Often complicated testing cannot be reproduced easily by different manufacturers, thus researching multiple tests can result in determining a manner to compare results from different test methods and determine the accuracy of a simpler test relative to a more complicated test method. This allows users to conduct simple reproducible tests while addressing their error factors.

Ultimately of all the possible test methods two need to be selected, one as precise as possible, and the other easily reproducible. While the first test method may be used in the national standards for characterization of materials, the latter one is aiming at quality control of WRB products. Yet, the results from the quality control must be compared with results obtained from the national standards for characterization of materials method.

The water vapour test methods most commonly used today are the wet-cup and dry-cup methods. These methods consist of attaching a specimen over an open mouthed cup containing either water (wet-cup) or desiccant (dry-cup). The cups are then placed in a controlled atmosphere and weighed periodically. For the dry cup testing the used desiccant must be replaced with dry desiccant when weighing occurs, which is normally every 48 hours. Once a steady state of weight loss or gain is achieved, permeance, and resistance can be determined. This test method is adequately described in ASTM-E-96 (2003), it is an efficient test method but it requires complicated equipment in order to assure proper climate control.

On the other hand, as the literature review will show, there are not many, easy to perform but precise enough for quality control test methods. This thesis will therefore examine what methods can be used to determine permeability of weather-resistive barriers (WRB) for the quality control. A double cup method in which the specimen is placed between two cups is the method analyzed in this thesis. The main factors evaluated are:

- Precision and reproducibility of test methods.
- Determination of the still air layer and surface resistances.
- Temperature and relative humidity control within the testing environment.
- Determination of accurate testing methods for breather type materials.
- Determination of test method precision within a low temperature controlled environment.

1.3. Contributions

This research determined that the surface resistance is material dependent, thus questioning the validity of using the ASTM E-96-03 approach of applying a constant value regardless of the material being tested.

Tests proved that the stringent temperature control requirements are necessary when dealing with tests performed where one side of the tested materials RH is above 52% RH. While plus minus 1.5 degree of temperature oscillation was acceptable for testing type P with the double cup method, this limit was not stringent enough for type C products.

Chapter 2: Literature review

2.1. Introduction to water vapour transmission (WVT)

Many different test methods have been created to determine permeability of materials. Development of these test methods has evolved since 1930's, and many scientists have aided in the understanding of the factors affecting test methods and have further developed the methods.

2.1.1 Diffusion Coefficient

According to Babbitt (1939), to fully understand moisture movement through building materials three factors must be investigated:

- The temperature distribution through the wall, which is dependent on inside and outside temperatures as well as the thermal resistance of the various parts of the wall.
- The moisture content of the air on both the interior and the exterior of the structure.
- Resistance of the various parts of the wall to vapour movement.

In cold climates, the exterior portion of the wall plays a secondary role to the interior portion, this can be observed by the importance placed on the presence of vapour barriers on the inside portion of the wall. Since any moisture within the wall should have the capability of exiting the exterior portion more rapidly than it enters the interior portion of the wall. This system reduces the possibility of moisture accumulation and allows condensation factors to be eliminated. One method of accomplishing this type of wall system is to have many holes or cracks in the exterior thus allowing moisture to quickly exit the system. This however is not the most desirable solution since it allows for air and rainwater to enter the system. A possible solution to this problem is to create an

interior system impervious to moisture penetration and allowing the exterior portion to be closed without risk of condensation.

The distribution of moisture through a wall under equilibrium can be accurately calculated once the three factors listed above are known. The temperature distribution can be determined through the knowledge of interior and exterior temperatures. Thermal conductivity of each material can be known and through the use of a table of dew-points the probability of condensation can be determined. These calculations can be easily applied and the moisture movement can be determined.

Water vapour transmission can be very complex when examining porous materials. Most building materials used are hygroscopic, thus they are capable of absorption of moisture from the ambient air. The absorption of a material depends on many factors and in most cases a non-linear relation can be obtained.

In most cases, however, water vapour transmission through a porous material is assumed to be simplified so that it is acceptable to refer to the laws of diffusion, which includes Fick's law:

$$W = \frac{dAt}{X}(P_1 - P_2) \quad (1)$$

W = weight of water diffusing (kg)

T = time (hr)

X = material thickness (m)

A = area (m²)

P_1 = vapour pressure on one side (Pa)

P_2 = vapour pressure in the opposite side (Pa)

d = coefficient of diffusion or diffusivity (m²/hr)

The above equation states that the rate of water vapour flow passing through a material slab area is directly proportional to the vapour pressure difference and inversely proportional to the thickness.

2.1.2 Water vapour transmission

Relation between the moisture and the solid, moisture within the solid is often dependent on the pore size, thus if the pore size is large enough moisture may take the form of vapour, liquid, or ice. The moisture may be present as a chemical compound, it may be absorbed on the surface, or it may be dissolved within the crystal structure of the solid. We therefore talk about four states consisting of (added) vapour, liquid water, ice, adsorbed water.

The generalized equation of flow can be determined using the Navier-Stokes equation¹ which, allows for each of the four states to be quantified, the equation is as follows:

$$\rho \frac{Du}{Dt} = -\frac{\partial p}{\partial x} + F_x + A_x \quad (2)$$

Where:

- D/Dt = differentiation following the motion of fluid
- ρ = density
- p = pressure
- u = the component of the velocity in the x – direction
- F_x = the external force
- A_x = the force opposing the motion of the fluid
- $\rho Du/Dt$ = the accelerative or inertial force

External forces may be overlooked in these cases since the pressure gradient is balanced by the resistive or frictional forces, thus at the steady state the equation becomes:

$$\frac{\partial p}{\partial x} - A_x = 0 \quad (3)$$

1. Babbitt J.D., “The movement of moisture through solids”. ASTM Bulletin, February 1956.

The migration of moisture as a gas, the laws of gas flow through a porous solid have been significantly researched in the past, however these laws do not adequately consider the relation between the various flow mechanisms. By applying the above equation, these factors can be determined through A_x .

Gas flow under an absolute pressure gradient is present when vapour moves through a material due to absolute pressure, there are many possible causes of movement, which are dependent on A_x , which is a summation of the forces that effect the movement of the individual molecules through the pores. According to Babbitt (1956), these forces depend on the mean gas pressure, the pore sizes, and the relation between the mean free path of the gas molecules and the dimensions of the pores and capillaries.

Gas flow under a partial pressure gradient is most commonly known as diffusion, this occurs when inter-diffusion of gases in free space takes place. The rate of flow depends on the gradient of partial pressure.

The water flow is driven by the gradient of hydraulic pressure, as defined by Darcy's law:

$$\frac{\partial p}{\partial x} + \frac{\mu}{k} u = 0 \quad (4)$$

Where:

- p = hydraulic pressure (Pa)
- μ = viscosity (N s/m²)
- k = permeability (m²)
- u = velocity of flow (m²/s)

This equation is similar to the Navier-Stokes equation since A_x is equal to $(\mu/k)u$.

In order for movement to take place sufficient space must exist in the pores, thus allowing for the moisture to move as a liquid. This type of liquid movement is greatly affected by capillary forces, and must be considered when calculating the hydraulic head.

The migration of moisture can also take place in the adsorbed state. When the water molecules are bound to the surface of the solid in such a way that they are in equilibrium with water vapour at a pressure lower than that which exists over liquid water at the same temperature, it is considered adsorption. *“The adsorbed molecules are distributed throughout the body of the adsorbing solid, presumably on internal surfaces, and it is evident from elementary considerations that these adsorbed molecules are capable of movement with the solid”*¹. When thickness of the adsorbed layer exceeds a few molecular layers we talk about the absorption process. Often absorption is considered as a major cause of moisture movement in porous materials. This highlights one of the main limitations of the simplified approach based on the “diffusion” of vapour, because Fick’s law does not take into account the surface flow (flow in the absorbed water). In effect, one must consider separately the movement of the molecules that are bound to the surface as well as those that are free in the form of a vapour contained in the pore space.

When looking at adsorbed and absorbed vapour, molecules which are free to move back and fourth in the space will cause pressure fluctuations due to the motion of the molecules. This pressure field will be two-dimensional since the space is confined by the surface. This pressure will cause the gas to remain on the surface causing it to spread, and can be referred to as “spreading pressure”. This pressure (P_{sp}) can be calculated by using the equation:

1. Babbitt J.D., *“The movement of moisture through solids”*. ASTM Bulletin, February 1956.

$$p_{sp} = -\frac{\partial F_{ad}}{\partial A} \quad (5)$$

Where:

F_{ad} = free energy of water molecules adsorbed on an area A . (It can be obtained from adsorption isotherms).

A_x can now be determined from the nature of the resistive force. The resistive force must be represented by the function of the activation energy; this is because the migration occurs due to adsorbed moisture moving from one adsorption site to another through the internal surfaces of the solid. The activation energy is the force required to move the moisture over the resistive barriers from site to site. By using a macroscopic picture of the resistive force an acceptable determination of the force can be found. Based on the phenomenon of the moisture moving with a velocity u over the surface of the solid as a film then the resistive force will be similar to that of a frictional force and will then be proportional to the velocity of flow. It can then be assumed that the force is equal to Cu where C is a coefficient of resistance. The equation will then take the form of:

$$\frac{\partial p_{sp}}{\partial x} + Cu = 0 \quad (6)$$

2.1.3 Test methods

When investigating water vapour transfer through a material the objective is to determine the amount of moisture, which passes through the material relative to time at various relative humidities. The earliest evidence of water vapour transmission testing occurred in 1939 and was documented by J.D. Babbitt at the National Research Council Canada (NRCC). He achieved this by using the cell method, which consists of placing

the material being tested over a dish or cell containing the desired relative humidity solution, or desiccant. The apparatus was then placed inside a controlled environment, where temperature and relative humidity could be controlled. Once equilibrium was obtained, the weight gain of the cell was determined as well as the weight of water diffusing through the specimen.

In Babbitt's research (1989), two types of cells were used as shown in Figures 2.1 & 2.2. The apparatus shown in Figure 2.1 was applied when testing thick samples, similar to a crystallising dish it consisted of a straight-walled glass vessel. The specimen was then placed flush with the upper edge of the vessel, the edges of the specimen were then waxed in order to avoid edge loss and placed in the cell. The edges of the specimen and the wall of the vessel were also sealed with wax.

The apparatus shown in Figure 2.2. was used when testing samples up to 1 inch in thickness. This assembly was constructed with duralumin. The specimen rested on a horizontal rim and was firmly pressed together by a screw cap. The surface was coated with wax and heated in order to insert the specimen.

The cells were filled with a solid desiccant (calcium chloride) and were filled to capacity in order to eliminate the air space between the desiccant and the specimen which reduced error due to vapour pressure assumptions. The cells were then placed inside a constant humidity chamber.

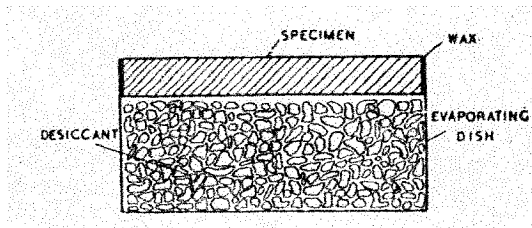

Figure 2.1. Cell used for thick samples.

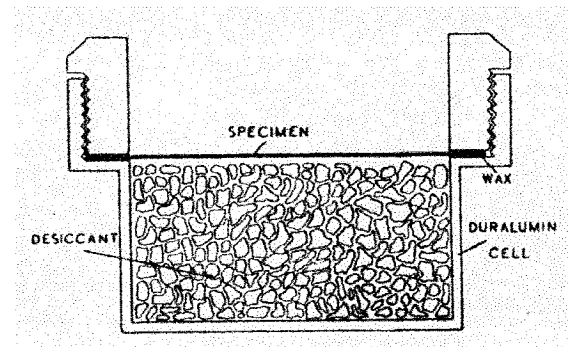

Figure 2.2. Cell used for samples up to 1 inch thick.

The tests were operated at a temperature of 90°F and at a relative humidity of 75%. The cells were weighed every 24 hrs, the increase in weight was plotted against time. The vapour transmission per hour was obtained once a straight line occurred in the measurements the slope was then measured.

Babbitt (1939) tested a variety of different building materials such as Presdwood, fibreboards, many different wood species, Kraft paper, rubber, asphalt papers, and corkboards. Diffusance (diffusivity) values were determined and published. Through a series of calculations the vapour gradient through a wall could be calculated, and the saturated vapour pressure could be plotted resulting in whether or not condensation had the potential of occurring in the wall.

In 1940, Babbitt published a second document regarding permeability of building papers to water vapour. The document provided diffusance (diffusivity) values of more materials than the original document from 1939, the tables included materials such as: sheathing papers, asphalt saturated rag felts, saturated asbestos felts, asphalt saturated and coated sheathing felts, asphalt saturated sheathing papers, asphalt saturated and coated

Kraft papers, asphalt coated Kraft papers, tar-saturated rag felts, tar-saturated sheathing papers, duplex papers, waxed papers, heavy roofing papers, and infused papers.

The first time water vapour transmission was documented by the American standards for test methods (ASTM) was in 1953 and was named E96-53T, “Standard Test Methods for Water Vapour Transmission of Materials”. The objective of this standard was to determine water/vapour transmission through various materials, for thickness as large as 32 mm. The standard defined two test methods called desiccant method and water method, both tests allowed for variations in humidity levels.

The desiccant method consisted of sealing the specimen through the use of wax to the open mouth of a glass dish, the dish contains dry desiccant (calcium chloride). The complete apparatus was then placed in a controlled atmosphere. The water/vapour transmission data was collected by periodically weighing the assembly. The water method was the same as the desiccant method except the desiccant was replaced by distilled water. With both test methods it was important to keep the atmosphere as close to the specimens intended conditions when in use since the results from different test conditions are not applicable to others.

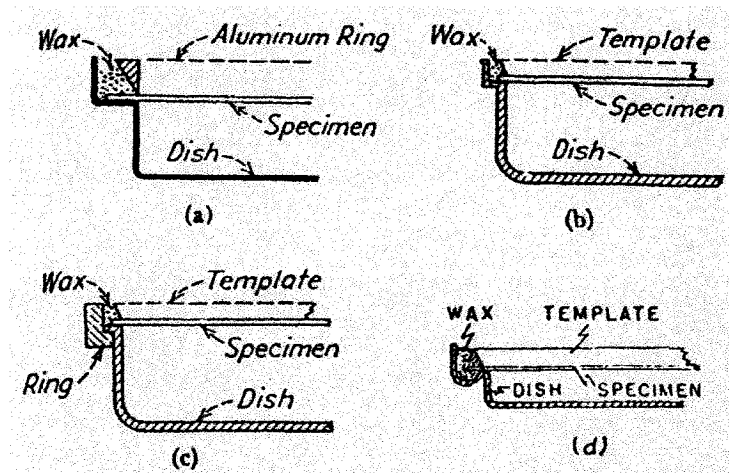

Figure 2.3. Testing apparatus for several dish types, ASTM E-96-00.

ASTM E-96-00 defines that water vapour transmission can be calculated by using the following formula:

$$WVT = \frac{G}{A} = \frac{G}{At} \quad (7)$$

Where:

G = weight change (g)

t = time during which G occurred (h)

A = test area (cup mouth area), (m^2)

WVT = rate of water vapour transmission, ($g/h \cdot m^2$)

In 1965 F.A. Joy and A.G. Wilson published a paper, which investigated the possible errors and their impact on test results based on the dish test methods as per the 1953 ASTM. In addition different possibilities in result calculations and analysis were indicated. This publication seriously considered the validity of the test and through the use of introduced calculations offered much insight to the true value of the test method.

Joy and Wilson first introduced a new manner of analysing of the results of the dry and wet cup test methods, by addressing the fact that vapour permeability is directly affected by the relative humidity surrounding the specimen as well as the absorbed moisture within the specimen. By implementing certain formulas a spot permeability curve could be determined based on research conducted by C. Chang and N.B. Hutcheon in 1956. The spot permeability curve represents the effects of the R.H. of the transmission through the test specimen, and each material had different effects. In order to increase accuracy of the testing of the materials through the use of the two test methods, the temperature conditions need to be identical, since as seen in Figure 2.4. the curve is slightly lower at $-12^\circ C$ ($10^\circ F$) compared to $21^\circ C$ ($70^\circ F$). Also the curve is

flattened by the decrease in temperature and it was determined that better results are acquired when using 21°C (70° F).

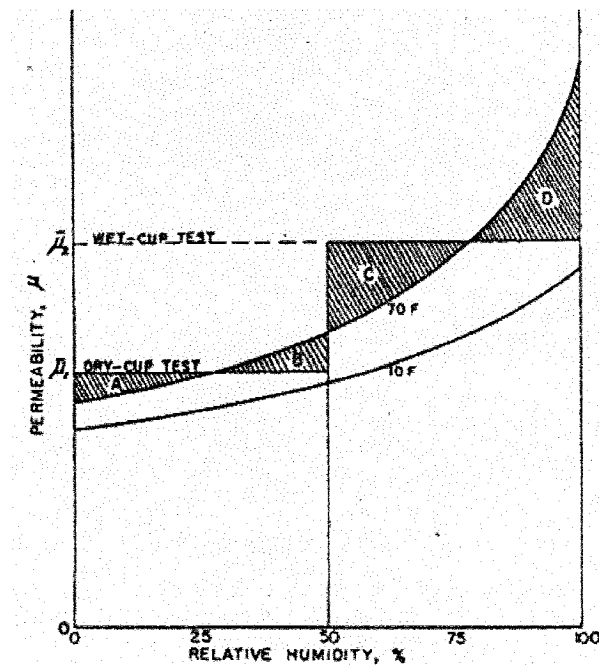

Figure 2.4. Spot permeability curve by Joy and Wilson in 1965.

Joy and Wilson's research covered the errors related to the test cup design and the sealing system. The requirements of both factors were similar to those of the ASTM E-96-53 which was the most recent version of the test method at that time and is similar to ASTM E-96-00 which is in current use today. The masked edge effect was also addressed, introducing a new element to consider when testing. Joy and Wilson's research was the first documentation of the effects of the cup conditions relative to the dry and wet cup test methods. They discussed the effect of the air space and its added resistance to the water vapour transfer. In Babbitt's research the surface resistance of the material was addressed but the air space had not been taken into consideration. The steady state and weight errors like the aforementioned factors will be discussed in full in section 2.2.

The first ASTM relevant to water vapour transmission was ASTM E-96–53, and was the first of its kind, eventually this led to the International Organisation for Standardisation (ISO) to implement the test method in 1970 and was called R 1195 “Determination of the water vapour transmission rate of plastics films and thin sheets, dish method”. In both standards the test methods consisted of Babbitt’s original method and in addition included factors from Joy and Wilson’s research.

German standard (1971) used for testing thermal insulation, through the use of the dry and wet cup tests was the first to introduce a method to calculate for the still air layer resistance. Using the diffusion coefficient, the water vapour diffusion resistance could be determined by:

$$Z = \frac{S_d}{D} \quad (8)$$

Where:

Z = the water vapour diffusion resistance (h/m)

S_d = the equivalent diffusional air layer thickness (m)

D = the diffusion coefficient (m²/hr)

The standard clearly lists the requirements for sample measurements, number of samples, as well as execution. The test lists the chamber environment to consist of an air temperature of ± 0.5 °C, and a mean relative humidity of $\pm 2\%$. In the case of large porous materials the air motion over the samples shall not exceed 0.5 m/sec. A distance of no more than 10 mm between the sample and the surface of the absorbant material must be present in the dry cup test.

Once the test is conducted the equivalent diffusional air layer thickness S_d can be calculated according to:

$$S_d = \delta_L \cdot A \cdot \frac{P_1 - P_2}{I} - S_L \quad (9)$$

For homogeneous materials the following equation shall be used in its place:

$$\mu = \frac{1}{S} (\delta_L \cdot A \cdot \frac{P_1 - P_2}{I} - S_L) \quad (10)$$

Where:

δ_L = the diffusion conduction coefficient of water vapour in air (kg/(mhr(N/m²)))

A = the test area of the sample in (m²)

P₁ & P₂ = the water vapour partial pressure at the sample (N/m²)

I = the steady state condition or the amount of water diffusing through the sample (kg/hr)

S = the mean thickness of the sample (m)

S_L = the mean thickness of the air layer in the test vessel below the sample (m)

When testing materials with a diffusional equivalent air layer thickness (S_d) of less than 1.0 m then the mean thickness of the air layer in the test vessel below the sample (S_L) can be disregarded.

This standard was the first to recognise Schirmer's equation which is:

$$D = 0.083 \cdot \frac{P_o}{p} \cdot \left(\frac{T}{273} \right)^{1.81} \quad (11)$$

Where:

D = the diffusion coefficient in (m²/hr)

T = temperature of the test chamber in (° K)

P_o = the atmospheric pressure at standard state (102325 N/m²)

P = the mean air pressure in the test chamber in (N/m²)

The diffusion coefficient represents the driving water vapour partial pressure and the water vapour mass moved by the diffusion of the water vapour in the air.

The standard expanded the equation and introduced a new method of calculating the air layer:

$$\delta_L = \frac{0.083}{R_D \cdot T} \cdot \frac{P_o}{p} \cdot \left(\frac{T}{273} \right)^{1.81} \quad (12)$$

Where:

δ_L = the moisture permeability in the air in (kg/(m·h·Pa))

R_D = the gas constant of water vapour (462 Nm/(kg K))

T = the temperature of the controlled atmosphere chamber in (K)

P_0 = the standard atmospheric pressure (1013.25 hPa)

p = the mean pressure in the controlled atmosphere chamber (hPa)

The Nordtest methods are standards used in Scandinavia (Norway, Sweden and Finland). The standard “Materials, thin: Water vapour permeability”(1984), consisted of a basic wet and dry cup test methods similar to that of Babbitt’s original method with some evolution.

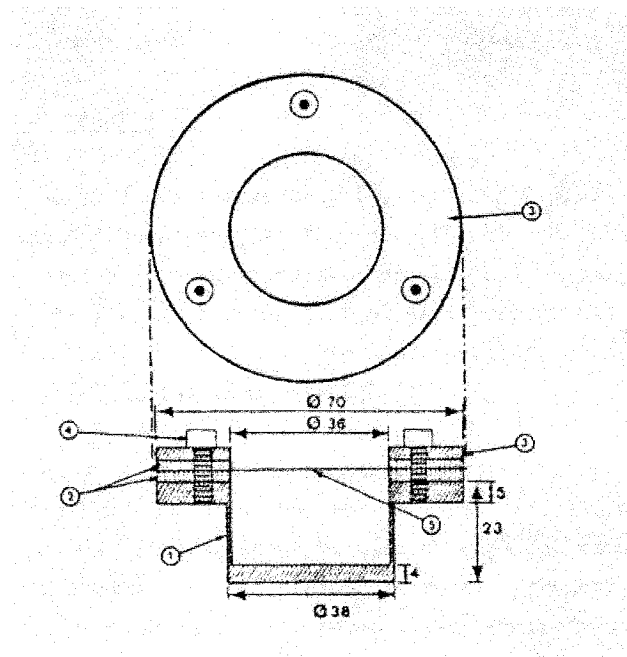

Figure 2.5: Test apparatus, Nordtest method, (1984).

Where 1 is the cup, 2 are rubber gaskets, 3 is the top flange, 4 is a screw, and 5 is the barrier sample.

The standard did however take into consideration many factors in regards to additional resistances in the measuring system.

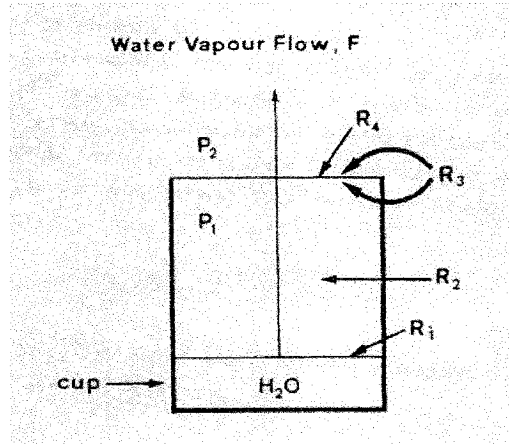

Figure 2.6: Water vapour flow, Nordtest method, (1984).

The above graphic indicates the resistances where R_1 is the water evaporation, R_2 is the air gap diffusion, R_3 is the film surface resistances, R_4 is equal to d/δ_∞ which is the sample resistance, and $p_1 - p_2$ is equal to Δp which is the driving force.

By applying the above information the flux of q , which is the equilibrium flux of water vapour through a unit area of the sample ($\text{kg/s}\cdot\text{m}^2$) and can be determined as:

$$q = \frac{\Delta p}{d/\delta} = \frac{\Delta p}{d/\delta_\infty + R_1 + R_2 + R_3} = \frac{\text{Driving force}}{\sum \text{resistances}} \quad (13)$$

The resistances could then be expressed as:

$$\frac{d}{\delta} = \frac{d}{\delta_\infty} + R_1 + R_2 + R_3 \quad \text{and} \quad \frac{1}{\delta} = \frac{1}{\delta_\infty} + \frac{1}{d} \cdot \sum R_i \quad (14)$$

Where:

δ represents the apparent permeability coefficient calculated from the first equation, and δ_∞ is the corrected permeability coefficient. The document gives little information apart from the test procedure and the above listed equations.

By 1987 an additional method for water vapour transmission was introduced and first published in the proceedings of the symposium on building physics in the Nordic countries, it was called the inverted cup method and was documented by Thorsen. The

method had been first recommended by Bertelsen (1982) and was further developed by the DIAB (Engineering academy of Denmark). This method basically consisted of inverting the ASTM E96 wet cup test method, and three systems were studied, ordinary, inverted and inverted-aired cup. The document focuses mainly on the two inverted test methods.

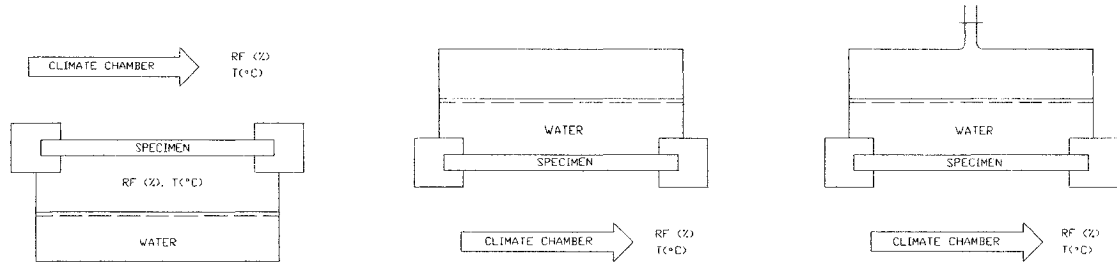

Figure 2.7: Inverted cup method, Thorsen, (1987).

In the de-aired inverted cup test method the Darcy coefficient could be determined since the water is in direct contact with the specimen and the material is vacuum saturated. The test must be conducted in a climate chamber under specific conditions in order to produce reliable values for the Darcy coefficient and the permeability. The document lists the difficulty in determining the coefficient when performing tests on hydrophobic membranes but the permeability can be determined despite this factor. The tests were conducted under identical conditions and weighed periodically as a unit the steady state condition was achieved.

Thorsen calculated the water flow through the use of Darcy's law, and assumed that the Vapour diffusion could be calculated using the mass of moisture under stationary conditions:

$$q = K \left[\frac{(P_1 - P_2)}{L} \right] \quad (15)$$

Where:

K = water permeability coefficient (kg/Pa•m•s)

L = the thickness of the specimen (m)

P_1 & P_2 = Vapour pressure (Pa)

To date these tests have been carried out on membranes in contact with porous materials, and was placed either on the “wet” or “dry” side of the porous materials.

Thorsen’s research concludes that it seems that it is possible to estimate the coefficients of vapour diffusion.

In 1986 G.H. Galbraith and R.C. McLean published a document named “Realistic vapour permeability values”, the document dealt with ongoing debatable issues regarding permeability testing at the time. The paper discussed the problems related to testing under certain conditions and how often those conditions were not representative of the climates where the materials being tested would be used, thus determining that the differential permeability is simply a prediction. The standards of that time for Britain, America, and France were considered to be of concern since the standards, which were suggested for determination of permeability of many different building materials, included porous materials. The problem with the tests was that the permeability values for the porous materials were applicable for the test conditions but were not considered precise enough to predict permeability for different service conditions. Also, the British standard of that time did not use an accurate temperature for the performance of the material during cold months and thus the values from the test could be deemed inaccurate.

When studying the three standards Galbraith and McLean noted that the standards from one country to another varied significantly. They also examined published values of plywood permeability from 5 different sources and determined that in many cases the

test conditions were not stated, and the values from the different sources were contradictory to one another, also none of the specimens were properly described.

The experimental procedures all indicated the need for a dry cup test and only the American standard suggested the use of a wet cup test as well. The testing using the dry cup method under different climatic conditions was deemed too lengthy and Galbriath and McLean decided to investigate the use of different salt solutions in order to generate a proper differential permeability curve that reduced the length of testing. They chose to test plywood since many variations were present with existing values from multiple sources. Once the tests were completed and the curve generated results that were deemed credible with an error range never more than 10%. They concluded that two humidity regimes existed and the range between the two regimes was within the RH levels of 60% to 70%. When the material was subjected to humidities below the range the decrease in permeability was small, however, above the range the permeability increased significantly with the increase of RH levels. Thus proving that using published values for permeability where test conditions were not properly referenced was not safe practice when designing. Also, even when the test conditions were referenced the material in question often bared little resemblance to the material used in practice, especially when dealing with porous materials. They concluded that there was a necessity for a standard test method with realistic results to be determined.

Bomberg (1989) in a paper "Testing Water Vapour transmission: Unresolved issues" lists the most significant factors affecting the WVT, such as mean temperature of the specimen, mean relative humidity, temperature and humidity gradients associated with different thickness of the test specimen. This paper stressed that the test selection

should be based on the objectives to be achieved. For tests aimed at comparing materials, the used test method should be an isothermal test such as the dry cup procedure of ASTM E-96. For examining the effects of boundary conditions on the WVT, the desired service conditions may be implemented however, this system does not necessarily produce accurate WVT.

The most significant portion of this paper was the stress on that the ASTM E96 was deemed most accurate only in the dry cup version. This test method produced more reliable results when testing all types of material including hygroscopic materials. The uncertainties of the dry cup test method are fully discussed and consist of sealing edges, RH oscillations, air flow, insufficient surface area, barometric pressure, stabilisation of vapour flux, and calculation technique.

Another paper by N. Schwartz, M. Bomberg and M. Kumaran (1989) introduced a new method which consisted of combining the dry and wet cup test methods and was named the modified cup method.

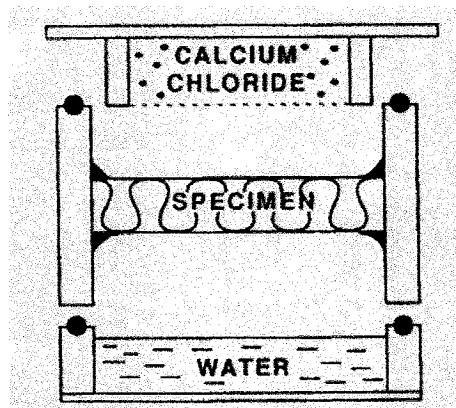

Figure 2.8: Modified cup test method, Schwartz et al. (1989).

This method requires temperature control but not control of relative humidity since it is a closed system, unlike the systems specified in ASTM E96. This test system allows for water loss as well as moisture gain to be monitored, and results in the users

awareness of a system failure should one be present. Also, this test method determines if any water accumulation occurs within the material being tested. Furthermore the test method was adapted for thermal gradient testing, and it was concluded that moisture accumulation occurs under these circumstances and not under isothermal conditions for the types of foams tested.

The tests were conducted using two types of foam consisting of polyurethane and polyisocyanurate foams. Previous research suggested that these foams were fairly resistant to moisture movement when under isothermal conditions and that resistance decreased under thermal gradient conditions. It had also been proven that the foams had a smaller resistance after 100 days of testing than after 200 days of testing when the resistance was so high that moisture movement could be overlooked.

The testing process considered three test methods, first was the ASTM E96 dry cup test method, second was the newly developed modified cup test method, and third was the temperature gradient method where the modified cup apparatus was used with a hot plate located below the water cup and a cold plate located above the desiccant cup. The results proved that the dry cup and the modified cup test methods were identical in their determination of the materials permeability. They also concluded that the modified cup test method was more reliable since only temperature control is necessary, and that the test method provides moisture accumulation values within the specimen if it is present, as opposed to the dry cup method where this factor cannot be accounted for.

The temperature gradient test method was deemed less precise than the other two test methods since the water vapour pressure gradient across the specimen could be determined, this was not the case with the temperature gradient test method and thus

induced a higher level of uncertainty. When analysing the results an increase in moisture transfer was observed when the testing temperature was above 21.5 °C, this is the case with all three test methods, thus determining that the water vapour pressure gradient may not have been available for proper calculations of the temperature gradient method but the test method may in fact be credible since the materials moisture increase pattern was identical for all test methods used.

The results also proved that the material did not suffer from moisture accumulation under isothermal methods, and did have moisture accumulation under the temperature gradient method. It was concluded that most likely moisture was trapped within the material in the warmer regions at the beginning of testing, and it also proved that the phenomenon of moisture movement can occur whether there is through transport or not, since the moisture movement patterns of the three test methods were identical. With certain materials tested, with the temperature gradient method, steady state could be observed after 37 days and with others the steady state was achieved only after 64 days. The conclusion was that with the materials, which took longer to achieve steady state, there was no increase in moisture content thus suggesting that the moisture was trapped and that these conditions would significantly reduce the thermal performance of the material. The moisture content and the rate at which the material absorbs the moisture is primarily dependent on the boundary conditions. One factor, which needs to be further investigated, is that of the rate of moisture transmission being unaffected by the amount of moisture accumulated within the specimen, it was concluded that this could be caused by unique physicochemical processes associated with the moisture transmission through the foams.

The following year, 1990, K.K. Hansen and H.B. Lund published a paper in the proceedings of the 2nd symposium, Building physics in the Nordic countries. The paper was named “Cup method for determination of water vapour transmission properties of building materials, sources of uncertainty in the method”. The paper looked at the various sources of uncertainty in the test method and how they relate to the objectives of the test.

The errors which are discussed in depth consist of barometric pressure, surface diffusion resistance and air layer thickness, boundary effect by specimen connection to cup, relative humidity oscillations, errors in measuring instruments, final calculation of permeability, and reporting of test results. These factors will be further discussed in section 2.2.

The report determined that when testing building materials consisting of low WVT coefficients the barometric pressure is a significant factor, thus buoyancy effects should be included in the calculations or the test should be conducted for a long period of time in order to result in values which are representative of the material. When conducting tests on materials of high permeability a significant factor of uncertainty is the air layer thickness within the cup, tests proved that the RH levels of the solutions were not apparent in the air layer.

The document also found that the diffusion resistance of the material is often lower than the overall measured diffusion, which were corrected values taking into account the effects of surface diffusion resistances and air layer thickness.

Hansen and Lund also discussed the need for more stringent reporting of results and referred to a round robin test performed in multiple laboratories within America,

where results were erratic at best among the laboratories. They concluded that the values tested among different laboratories should be compared in order to assure proper results.

In 1990 a new Nordtest method was published titled, "Building materials: Water vapour transfer rate, permeance and diffusion resistance". The document was an extension of the 1984 standard as previously discussed and the new standard included a new requirement for the cup assemblies (Figure 2.9).

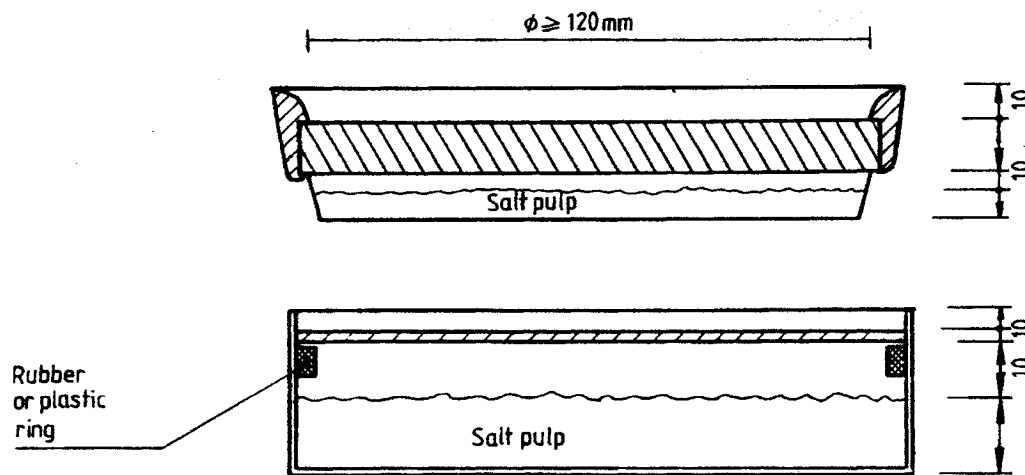

Figure 2.9: Nordtest method, (1990).

In ASHRAE transaction 1991 a paper named "Measurement of moisture diffusion in building materials" was published by Fanney, Thomas, Burch, and Mathena. The document focused on techniques they had developed related to moisture coefficients and consisted of a modified version of ASTM E96-80 of that time. The materials tests were white pine, gypsum board, and a latex paint coating at 24° C (75° F) and 7° C (44° F). Although moisture diffusivity and permeability had been well established the correlations between diffusivity, moisture content and temperature had not been adequately developed.

Tests were performed using the ASTM dry and wet cup methods, due to a particularly higher air velocity within the chamber dummy tests were conducted to study their effects. A third test was introduced called the modified cup method which consisted of placing the wet and dry cups within a dessicator with salt solutions in order to maintain certain RH levels within the dessicator. The modified cup method consisted of a larger space between the specimen and the solutions, and a wood dowel was placed within this space in order to monitor the moisture content at the specimen surface, however the values from the dowels proved to be erratic and thus determined that this space needed to be further investigated.

The results from the dry and wet cup tests showed that the tests were sensitive to temperature fluctuations, as well as changes in RH levels within the chamber. The tests proved that significant variations in diffusivity were apparent in white pine, and further tests were conducted in order to determine what was causing an error of 17.9%, multiple specimens from the same wood species varied depending on the different lots they were obtained from. When testing gypsum an error of up to 27.5% was recorded. The error factors were deemed to be caused by neglecting the external resistance on both sides of the specimen. Thus, discrediting any previous values published since this factor had not been accounted for, and any previous results would be significantly lower than what was reported.

When evaluating paint coatings on gypsum the addition of the paint coating proved to represent only 20% of the overall resistance, and increased the external resistance by 30%. The results obtained at a temperature of 44° F were erratic and could

not be considered accurate, thus explaining why previous values for paint coatings were not similar from one source to another.

When comparing results from tests with a small or a large distance between the specimens and the solutions the results varied, thus proving that air movement is still present within a closed compartment, most likely due to convection. In conclusion the external resistance was proven to have a significant effect on moisture transfer and must be taken into consideration when determining diffusivity or permeability of building materials. This resistance was determined to be affected by the temperature and relative humidity adjacent to the test specimens.

A similar document was published in ASHRAE, by Burch, Thomas and Fanney (1992), this document was an extension of their previous work reported in the 1991 paper, it included testing of additional materials. The tested materials were predominantly within the wood family and consisted of sugar pine, sturdy brace fibreboard, fibreboard sheathing, particle board, exterior grade plywood, plain gypsum board, Kraft paper, wafer board siding, vinyl covered gypsum board, and foam core sheathing. The document focused on combined heat and moisture transfer, multi layer construction under non-steady-state conditions and their relation to the introduced developed mathematical models of the time. The necessity for water vapour permeability data of varying materials was significant since these models were dependent on the values for the computer generated predictions, aimed at reducing moisture accumulation in construction.

They found that as the permeance of the material increases the resistance caused by the air layer also increases, therefore this factor was further investigated. The study

concluded that materials with a permeance of less than 1 perm ($5.7 \times 10^{-11} \text{ kg/Pa}\cdot\text{s}\cdot\text{m}^2$) the error factor was 3%, and materials with a permeance of more than 10 perms ($5.7 \times 10^{-10} \text{ kg/Pa}\cdot\text{s}\cdot\text{m}^2$) an error factor of more than 20% was present. Therefore with materials which have a permeance of more than 10 perms the calculations should take the air layer resistance into account, otherwise a significant error could be present in the results.

In addition the paper introduced a formula for calculating the resistance of the two air layers:

$$R_f = \frac{Ap_g(p_u - p_l)}{WVT} \quad (16)$$

Where:

$p_u - p_l$ = the equilibrium relative humidity of the saturated salt solutions at the upper and lower surface of the specimen, respectively.

A = the surface area of the specimen

P_g = the saturation pressure of water vapour

WVT is the water vapour transfer rate

R_f is the water vapour resistance from the two air layers.

However the formula does present a source of uncertainty due to the fact that the water vapour transfer rate is based on the difference in two measurements. Since the large difference in the salt solutions RH levels, their saturation is diminished over time. The formula for the resistance of the two air layers was based on researched performed in 1991 where one, two, and three layers of corkboard were tested. Once the resistance for all three layers was plotted a relatively linear relationship was identified and the resistance observed at layer zero was determined to be representative of the resistances present at the upper and lower locations of the cup. This value also agreed with the values obtained from the “dummy” tests, where no specimens were present in the test

apparatus. They concluded that further research was needed in order to fully understand the properties of the air layers.

Burch, Thomas and Fanney (1992), studied the many different materials previously listed, however only the Kraft paper values are relevant for this thesis and therefore the other materials mentioned will not be discussed here. The Kraft paper tested had a thickness of 0.15 mm and a density of 839 kg/m³. All permeance values were plotted over relative humidity and the Kraft paper fell into the criteria of a non-vapour retarder material, being slightly higher than 1 perm. Also, the material showed a relatively constant behaviour from 0% to 50% RH, and from 50 % to 100% showed a significant increase relative to the RH increase. The results were not conclusive with values from previous publications of Kraft paper permeance, this was deemed to be due to the fact that previous test methods did not consider the air layer resistance. The paper concluded that the temperature control had a significant effect on the permeability.

The ASTM E96-53 “Standard test methods for water vapour transmission of materials” has been revised and updated over the years and the latest published version of the test method is ASTM E96-00, thus published in 2000. This ASTM standard is often referenced and implemented in order to obtain permeability values for various materials.

This test method can be used to determine water/vapour transmission through various materials. These materials must not exceed 32 mm in thickness. Two methods are discussed in this document, the dry-cup and wet-cup methods, also included are variations of humidity levels. Though two types of methods are discussed it is important to realise that results from the different methods are not necessarily applicable to the materials being tested. The conditions of one test will not necessarily resemble those

under different conditions this is why the test method chosen should be one that resembles the actual conditions of use. The standards intent is for the results obtained to be expressed in suitable units in order to be of use in design, manufacturing, and marketing if desired.

The desiccant method can be seen in Figure 2.3, it consists of attaching a specimen to an open mouth dish, containing desiccant and sealing all connections between to two compartments. The assembly should then be placed in a controlled atmosphere and weighed periodically. The water method is similar to the desiccant method except the dish is filled with distilled water.

The apparatus used consists of the test dish, the test chamber, and the balance. The test dish must be made of a non corroding material which is impermeable to water and vapour, its size and shape is not specified, but it is important to realise that a light weight dish is necessary when using an analytical balance. The mouth of the dish has no maximum size but must be no less than 3000 mm² (4.65 in²), a ledge or flange around the mouth of the dish is necessary in order to accommodate the specimen placement, however when the specimen is larger than the mouth area the overlay becomes a source of error especially in the case of thick specimens. The overlay area should be covered to ensure the exact area being tested. This overlay can have effects on the test results from a 10% to 12% reduction in precision. The depth of the desiccant and water from the rim of the dish may range, the suggested depth is 19 mm for both methods.

The standard specifies that test chamber should consist of a room or cabinet where the temperature and relative humidity are controlled. The required temperature is between 21 and 32°C and must be maintained within ±1°C. The relative humidity should

be maintained at $50 \pm 2\%$. The temperature and relative humidity should be measured frequently or recorded continuously. Air circulation is necessary within the chamber and a velocity of between 0.02 and 0.3 m/s (0.066 and 1 ft/s) is specified.

The document states that the balance should be sensitive to weight changes of 1% at anytime during the testing, an analytical balance is recommended. The standard also defines requirements for materials, sampling, test specimens, and attachment of the specimen to the test dish. Both procedures are well described and an inverted cup method is introduced but not well defined within the standard.

The calculations consist of determining the water vapour transmission (WVT) (resistance) as in formula (16). Permeance values are then calculated as the inverse of resistance.

The standard states that when water is used the RH level at the specimen is assumed to be 100%, and when desiccant is used the RH level is assumed to be 0%, this is not always the case and a 3% error in the RH value can be present when testing specimens of less than 4 perms.

The standard includes a table showing results from an inter-laboratory test series where 12 laboratories tested identical materials, the repeatability was low and other sources concluded that the cause of the irreproducibility was due to improper sealing of the specimens.

ASTM E96-00 is the most current version of the test methods in circulation, however the ASTM is currently revising this standard and E96-03 is under development. The new version includes new results from inter-laboratory testing, and new correction factors are being introduced. They consist of buoyancy, air layer thickness, surface

resistance of the material, and the masked edge effect. These factors will be further discussed in section 2.2.

2.2. Errors in testing

2.2.1 Introduction

The systematic errors in most cases can be quantified and accounted for, thus improving the accuracy of a test method.

J.D. Babbitt (1939) and Joy and Wilson (1965) documented many errors and aided in understanding of factors affecting the precision of measurements. This chapter represents a collection of all pertinent research regarding error factors to date.

2.2.2 Apparatus design

Problems in the dry cup, wet cup as well as double cup methods (introduced in this thesis) often occur with the assembly of the different test components. The ASTM E-96 clearly lists purpose of the materials to be used when constructing the cups, they are to be of non corroding material, impermeable to water or water vapour, and a lightweight materials is preferable. While cups in the past were made of glass or metals, the joint between two components varied considerably from caulking compound to masking tape. Some of the materials proved to be unsuitable for low transmission testing and caused unreliable results. When aluminium cups are used for dry cup testing it is sometimes convenient to remove the lower portion of the cup for measurement purposes, certain sealing techniques can accommodate this type of procedure without increasing error. Aluminium cups can also be used for wet cup test but it is important to either anodise them or give them a protective coating to avoid corrosion, this can also be accomplished by applying epoxy resin.

2.2.3. Specimen sealing

Sealing of the specimens has proven to be vital when acquiring accurate results and has often been addressed when discussing these test methods. Toas (1980) concluded that improper sealing was the reason why a round robin test of ASTM E-96-00 failed, out of twelve laboratories deemed skilled in sealing techniques only three obtained acceptable results.

Sealing can be accomplished through the use of a template ensuring, identical areas on both sides of the specimen is necessary. According to different sources the sealant may consists of one of four mixtures:

- 50% beeswax and 50% rosin colophane heated to 275° C
- Asphalt heated to 82 to 93° C or its softening point. This can be further studied by referring to ASTM D 449, type C.
- 60% microcrystalline wax and 40% refined crystalline paraffin wax.
- 90% microcrystalline wax and 10% plasticizer.

2.2.4. Masked edge effect

The masked edge effect is a source of error, which is caused by a difference in the diameter of the specimen and the diameter of the cup. Research documented by P. Greebler (1952) addresses this issue, by using the method of conformal transformations and the following equation was applied:

Percent Excess WVT:

$$ExcessWVT = \frac{400t}{\pi S} \log_e \left(\frac{2}{1 + e^{-(2\pi b/t)}} \right) \quad (17)$$

Where:

t = specimen thickness (m)

b = width of masked edge (m)

S = four times the test area divided by the perimeter (m)

In Joy and Wilson's paper (1965), certain restrictions are stated relative to the masked edge when testing. The requirements are that when the specimen is less than 3mm and not larger than 30mm the tested area will be no less than 130mm with a masked edge no larger than 15mm. Should the test area increase then the masked edge may increase 3mm for every inch of increase to the test area. By applying these restrictions to the masked edge the error factor is decreased to 12% for homogeneous specimens.

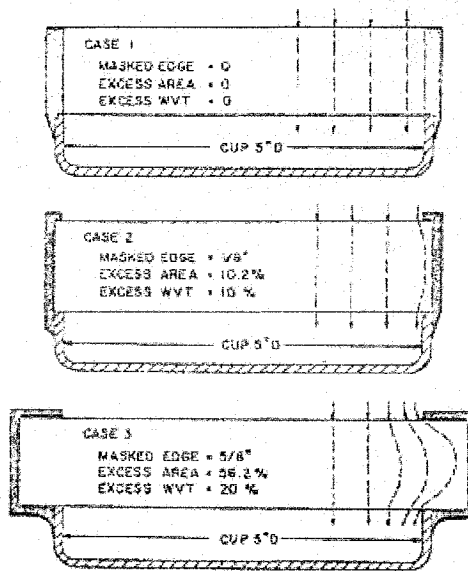

Figure 2.10: Masked edge effects for 5 inch diameter test area, Joy and Wilson (1965).

Figure 2.10 shows that based on Greebler's research of the masked edge effect it can be seen in case 1, with no edge the effect is 0% error, case 2 with 3mm edge 10% error is present, and case 3 with 6mm (half the thickness of the specimen) edge 20% error is present in the resulting transmission rate. It is important to note that these masked edge restrictions are only applicable to homogeneous materials, also if the material is laminated then the error may increase due to the higher resistance of the mid-plane and

its increase of permeable surfaces. In ASTM E-96-00 the masked edge effect restrictions have been implemented relative to the test area. In the recently proposed revisions of the standard (ASTM E-96-00) Joy and Wilson's equation is included, thus the masked edge effect can be accounted for more precisely.

2.2.5. Test chamber conditions

Test chamber conditions can often vary in temperature setting as well as temperature control, these effects can significantly alter test results. In some cases, where a closed chamber is used certain salt solutions are used to acquire different relative humidities, this system is a good method for achieving the desired relative humidity but in retrospect can create more uncertainty in results than a properly constructed test chamber. This is due to the fact that often these systems require the specimens to be removed from the chamber in order for measurements to be recorded, once the specimens are removed from the constant conditions then the relative humidity is altered and equilibrium becomes difficult to establish. If measurements are acquired often, such as once every 24 hours, once the chamber is opened the relative humidity will not be re-established within a significant amount of time. When salt solutions are used in testing the relative humidities are often documented and assumed to be accurate, in most cases this has been deemed accurate but some studies have shown that the stated relative humidity only occurs within the thin air layer directly above the salt solution and is not necessarily the case within the whole testing chamber.

One method used that may diminish the effects of salt solution uncertainty is to constantly record the relative humidity and to calculate the average. The saturated salt solutions are used and their respective pressure conditions are often applied in water

vapour transmission calculations, however their equilibrium is obtained from published sources and often the dynamic performance is not accounted for, thus their equilibrium is inaccurate since the relative humidity is a function of the rate of moisture gain or loss by the solution. The actual value at the surface of the specimen is not attainable since a measuring device is not usually continuously within the closed compartment. Hansen and Lund (1990) discussed the effects of assumed relative humidity levels in closed chambers through the use of solutions, they determined that temperature and air velocity directly affect the RH levels, and the only method for RH level control is to maintain an accurate temperature. They determined that a temperature control of 0.2° C will result in an error of 3%, and a 1° C temperature control will result in a 15% error, concluding that temperature control should be as precise as possible for testing.

According to ASTM E-96, when performing tests it is important that the temperature inside the chamber is within 2.5 ° C of the temperature of the location where weighing will occur, a temperature difference greater than 2.5° C has the potential to cause unwanted condensation on the surface of the specimen. ASTM E-96 states the need for performing a test on a “dummy specimen”. When specimens being tested are assumed to result in transmission of less than 7.5E-10 g/Pa·s·m, (0.5 perms), the dummy specimen is a test set-up without a specimen in place. By performing a dummy test any temperature and buoyancy oscillations within the testing chamber can be accounted for in the calculations. This dummy test is applicable to the dry cup, wet cup and double cup methods, but not possible when performing the modified inverted cup method. This is due to the fact that the inverted cup method requires desiccant in the lower portion of the cup with the specimen placed above it, and water is placed above the specimen. Without

a specimen in place the water would flow directly into the lower cup and no results would be achieved.

ASTM E-96 states that all methods listed in the standard have been successfully performed at 23° C and at 32.2° C as well as 37.8° C, however the standard requires that testing be performed within 21° C and 32° C, the latter being strongly recommended, the temperature should be maintained within $\pm 1^\circ\text{C}$.

The relative humidity in the chamber defined is $50\% \pm 2\%$, if the purpose of the test is to determine performance at a set relative humidity the range should be $\pm 2\%$ of the set R.H.

In the past control of air velocity over the specimen was defined in the test method and required to be above 2.54 m/s, information on air velocity can be acquired in many documents, however most documents are not consistent with each other. It is believed that air velocity does not need to be defined since different heat, air, and moisture (HAM) control systems may require low air velocities in order to be efficient. However, ASTM E-96 defines an air velocity between 0.02 and 0.3 m/s. Joy and Wilson's documentation (1965) provides a formula for laminar flow:

$$h_d = 8.64 \left(\frac{V}{L} \right)^{1/2} \quad (18)$$

Where:

h_d = average surface mass transfer coefficient, ($\text{kg}/\text{m}^2 \cdot \text{h}$)

V = air velocity, (m/h)

L = length of plate, (m)

When performing dry cup testing on highly permeable materials air velocity is a significant factor since the air pressure gradient can result in variation of air flow in and out of the cup. The tests results can be seriously altered due to variations in the air flow.

Another method to counter act the effect of air flow is to test 2 layers of materials as opposed to one.

In the double cup test method air flow is not present since the upper portion of the apparatus consists of a closed cup containing desiccant.

2.2.6. Cup conditions

When performing dry and wet cup testing the R.H. levels are assumed to be 0% for dry cup, and 100% for the wet cup, which is the R.H. value at the surface of the water or desiccant at the chamber temperature. This factor has been proven by Joy and Wilson to be minimal for low permeable materials and insignificant for high permeable materials.

2.2.7. Air space (surface resistance and the still air layer)

According to Joy and Wilson in 1965 the air gap between the wet cup and the specimen as well as the dry cup and specimen provides a resistance that should be considered. The air gap becomes an issue due to a pressure drop within the space. This is referred to as the still air layer and the typical value for still air at standard atmospheric pressure for 23°C is $181\text{E-}07 \text{ g/Pa}\cdot\text{s}\cdot\text{m}$, at 32°C is $209\text{E-}07 \text{ g/Pa}\cdot\text{s}\cdot\text{m}$.

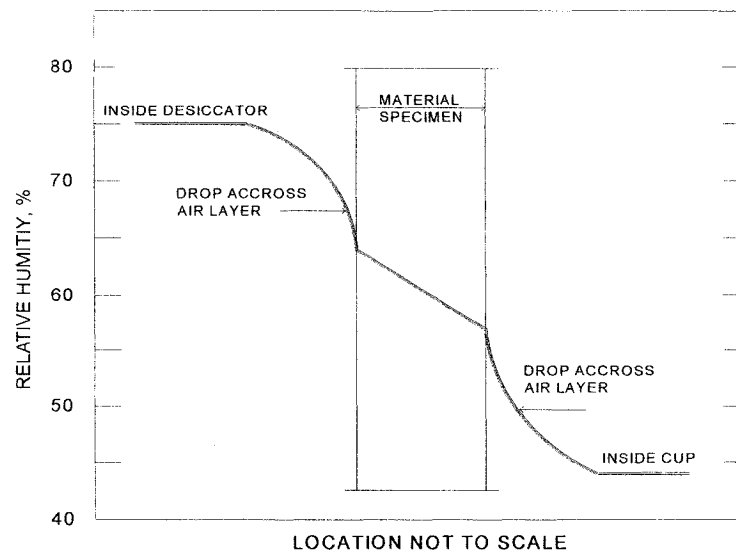

Figure 2.11: R.H. distribution across a painted gypsum board specimen. Burch and Thomas (1992).

ASTM E-96 limits this air gap by specifying the desiccant layer to be at a distance of 6mm from the specimen for dry cup testing. For the wet cup tests the water layer specified is to be at a distance of 12mm to 6mm from the specimen, this however can result in the water splashing and thus cause the testing to suffer from a greater source of error. One suggested manner to limit splashing is to place a grate within the cup. If the air gap is 16 mm or less then the error factor is less than 1% for a $1.45\text{E-}09$ g/Pa·s·m (1 perm) specimen according to Joy and Wilson. For a $8.7\text{E-}09$ g/Pa·s·m (6 perm) specimen the error increases to 5%.

Research conducted by Burch, Thomas & Fanney in 1992 used a slightly modified version of the ASTM E-96 it consisted of both dry and wet cup test methods where low permeability plastic films were placed above the air spaces in order to limit air movement. The specimens were placed inside dessicators, once the layer above the specimens reached equilibrium they were weighed then replaced and left for a one week time span, once weighed a second time the results for one, two, and three layers of corkboard proved that the factors could be accounted for. The air layers for both sides of the specimen could be determined through the use of formula (16).

When D.M. Burch and W. Thomas further studied this factor in 1992 they determined that the still air layer has a 5% error for a material of $1.45\text{E-}09$ kg/Pa·s·m or less, and more than 20% error for materials larger than $14.5\text{E-}09$ kg/Pa·s·m, which is similar to Joy and Wilson's (1965) aforementioned conclusions.

Another factor to consider when studying the air space is the surface resistance of the material, which is the thin layer of air directly above the surface of the specimen, the roughness of the surface determines the effect that the air velocity will have on the

overall movement of air over the material. Research conducted by Babbitt in 1939 addressed the surface resistance, materials were tested at different thickness' test results were then plotted and a line was drawn through the resistance points, the line was then extended to zero layers, if the line intercepted at zero on the origin (zero) then no surface resistance was present and Fick's law could be deemed as accurate. If the line intercepted at a different point on the y-axis then that value could be used as both the surface resistance and the still air layer correction together of the material and could be accounted for in the calculations. When testing materials such as wood the thickness of the specimens could be easily altered, however when testing thin sheet type materials this was not an option, thus multiple layer testing was created. Babbitt performed tests on Kraft paper and set-ups of 1 through 8 layers were tested.

In 1990 Hansen and Lund fully addressed both the surface resistance and the air layer thickness, they concluded that the following equation could be implemented in order to determined a way to find the water vapour pressure:

$$p_{1s} = p_1 - \frac{Z_a + Z_1}{Z_a + Z_1 + Z_p + Z_2} \cdot (p_1 - p_2) \quad (19)$$

Where:

Z_m = the water vapour resistance (Pa·s·m/kg)

Z_p = the resistance of the material itself (Pa·s·m/kg)

Z_1 and Z_2 = the resistance at the specimen surfaces, found by separate measurements or by Lewis' law (Pa·s·m/kg)

Z_a = the resistance of the air layer within the cup (Pa·s·m/kg)

p_{1s} = water vapour pressure (Pa)

The latest revisions of ASTM E-96-03 (under development) also address this factor, however in the past these factors had not been addressed in the standard. The corrections for resistance due to the still air layer and the specimen surface are deemed to

have a larger importance when testing materials of high permeability. They can be calculated using an equation based on the materials permeability and the thickness of the air space. The equation is as follows:

$$\delta_a = \frac{2.306 \cdot 10^{-5} P_o}{R_v T P} \left(\frac{T}{273.15} \right)^{1.81} \quad (20)$$

Where:

δ_a is the permeability of still air ($\text{kg} \cdot \text{m}^{-1} \cdot \text{s}^{-1} \cdot \text{Pa}^{-1}$)

T is temperature (K)

P is the ambient pressure (Pa)

P_o is the standard atmospheric pressure in (101325 Pa)

R_v = the ideal gas constant for water ($461.5 \text{ J} \cdot \text{K}^{-1} \cdot \text{kg}^{-1}$)

2.2.8. Determination of steady state

The determination of steady state is vital for proper water vapour transmission ratings. Steady state is accomplished once the measurements are plotted against time and a straight line parallel to the time axis is present. Steady state is dependent on the material being tests, and can be acquired after several days or several weeks. It has been observed that materials of low vapour permeability make take a longer period of time than those of high vapour permeability. When the specimens are frequently removed from the testing chamber the test conditions are affected, and may result in evaporation or moisture gain during weighing. Especially in the case of highly permeable materials a correction should be applied to the WVT of the material. In 1994, Hinchley and Himus conducted tests in temperatures ranging from 20° C to 70° C, they used a temperature controlled pan and placed it on a balance and counter posed it, eventually the balance stood level and by studying the original weight and comparing it to the time elapsed the following formula was produced, which was a modification of Dalton's law on evaporation from 1834:

$$J = 0.103(p_w - p_a)^{1.20} \quad (21)$$

Where J is the evaporation rate, p_w is the vapour pressure of the water surface, and p_a is the partial pressure of the water at ambient air temperature.

Joy and Wilson determined that a significant factor in determining steady state was that of the moisture content of the material before testing relative to the testing R.H. In order to minimise this factor the materials can be pre-dried or conditioned before hand in order to limit the time to reach steady state. Once weight change is minimal, barometric pressure can become a factor in achieving steady state and can be incorporated in the calculations to aid in acquiring the straight line when results are plotted, this can often prove to be useful when testing materials with low permeance. When testing highly permeable materials such as breathers which have a small moisture capacity steady state is established in a short amount of time and thus this error factor is of no significance to the results.

2.2.9. Barometric pressure effects

Barometric pressure can prove to be difficult to determine and to control, ASTM E-96-00 did not address the need to focus on barometric pressure when testing, unless the materials are of low permeability, then a dummy specimen should be used to determine whether or not there is an effect on the results. In 1989 Wilkins and Pullan addressed the effects of barometric pressure on WVT testing, when testing the WVT increased when the barometric pressure decreased and vice versa, thus proving that the effects could result in some error in testing.

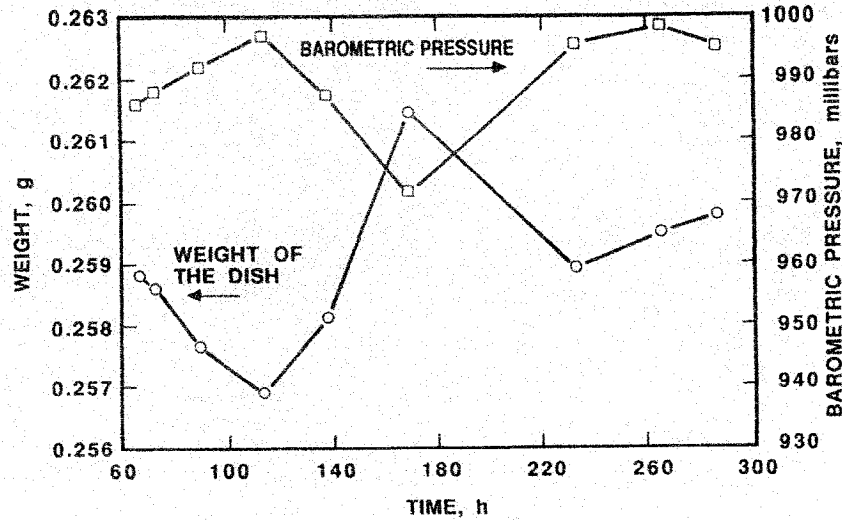

Figure 2.12: W.L. Wilkins and M.R. Pullan (1988).

Their research concluded that barometric pressure must be accounted for in the WWT coefficient calculations when testing low permeable materials of less than 0.05 perms (2.9 Ng/ Pa·s·m²). The ASTM E-96-03 (Under development) indicates that when testing materials which are highly permeable the gravimetric changes often override the changes in mass due to vapour transport. It is also stated that the calculation is needed when the mass change ranges from 0 to 100mg. These factors can be calculated using the equation:

$$\frac{m_2}{m_1} = 1 + \frac{\rho_a(\rho_1 - \rho_2)}{\rho_1(\rho_2 - \rho_a)} \quad (22)$$

Where:

- m_1 = mass recorded by balance (kg)
- m_2 = mass after buoyancy correction (kg)
- ρ_a = density of air (kg m⁻³)
- ρ_1 = density of material of balance weights (kg m⁻³)
- ρ_2 = bulk density of test assembly (kg m⁻³)

The calculation for the density of air can be determined by applying the ideal gas law for the measured atmospheric pressure and ambient temperature.

2.2.10. Frequency of data collection

Data collection often varies depending on type of specimen to be tested, as well as the condition of the specimen before testing. Specimens of high permeability often reach steady state in a lesser time than those of low permeability, thus measurements can be taken more often to ensure the accuracy of the data. However, if the test method requires the test specimen and cups to be removed from the testing chamber where a temperature gradient is present then the measurements should be conducted as little as possible without jeopardising the accuracy of the test results.

The condition of the specimen before testing can have an affect on the length of time of testing. Should the relative humidity difference of the specimen and the cup conditions be too great then this difference factor will extend the length of time until steady state is accomplished.

Chapter 3: Test methods

3.1 Double cup test method

The test method used consists of a double cup system developed by Schwartz, Bomberg, and Kumaran in 1989 (referred as the modified cup method). The method encompasses a moisture source, a membrane (or layers of membranes), and a moisture sink. The experiment is set up in a manner that moisture transmission can occur through the membrane and be absorbed by the moisture sink while transmission is monitored. This test method is similar to methods known as dry cup as well as wet cup but is not comparable to either.

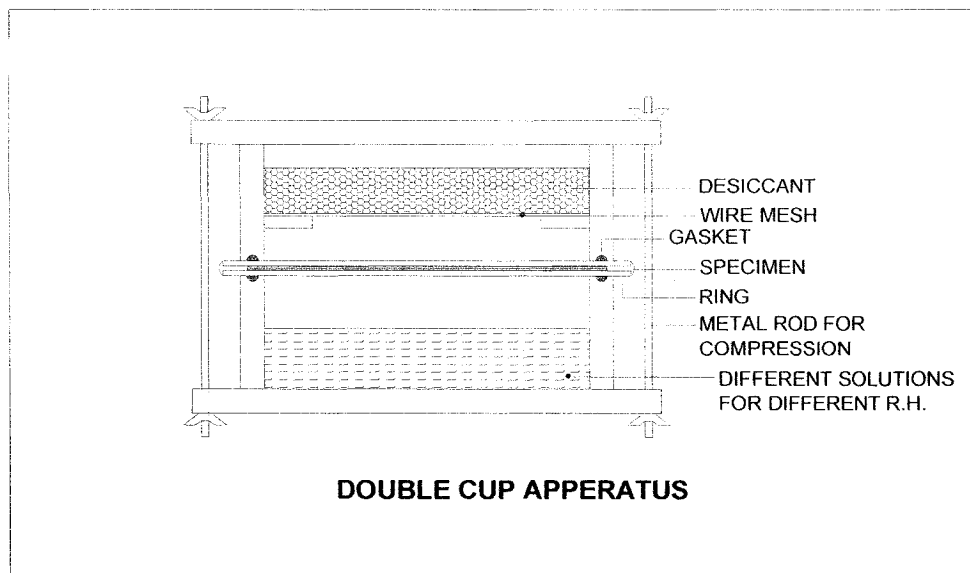

Figure 3.1: Double cup test apparatus.

The specimen after being cut, weighed and its thickness measured, is placed within two rings and waxed on the perimeter in order to form an air tight seal. The rings made of PVC and are 130 mm in diameter on the inside, 150 mm in diameter on the outside and are 2 mm in thickness. Wax is also placed on the inside edge of the rings, on

the solution side as well as the desiccant side. The wax mixture consists of 50% beeswax and 50% rosin. A circle is drawn on the specimen in order to wax the specific area being tested.

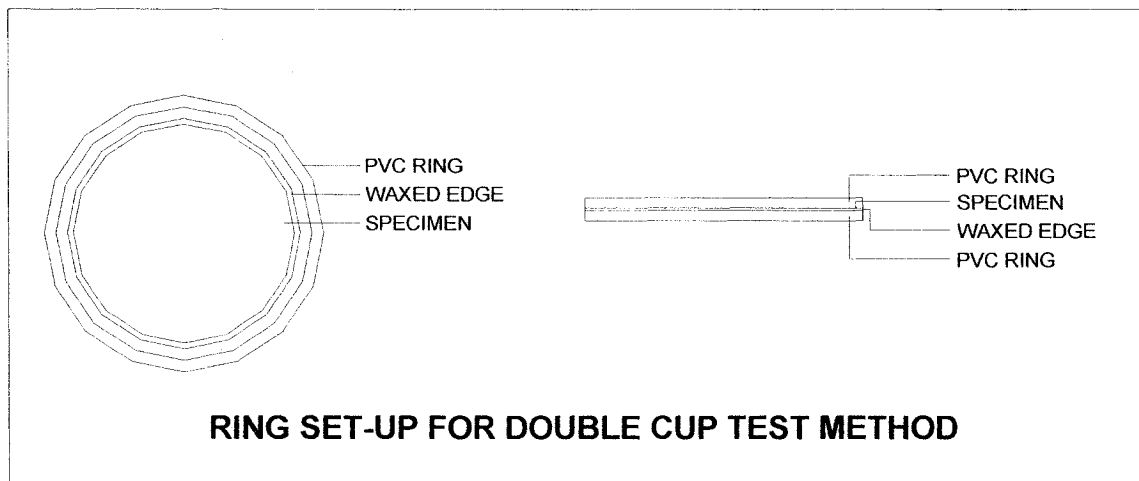

Figure 3.2: Double cup test ring set-up.

Both the upper cup and lower cup are constructed in the same manner, a 130 mm diameter PVC pipe is cut at a height of 50 mm it is then welded to a 190 mm flat round bottom 5 mm in height. A small opening is then cut into the top edge of the pipe to allow for the placement of a rubber gasket. Three holes are evenly drilled into the overhang of the flat bottom to allow for the compression rods.

The desiccant is placed in the upper cup, a thin wire mesh that is sewn to a thin filter fabric and is placed over the desiccant and it is held in place by a slightly oversized ring which is forced into position. The upper cup, containing desiccant, is then placed upside down, over the membrane rings. The connection between the desiccant cup, the solution cup and the membrane rings is air tight through the use of gaskets. The desiccant used is calcium chloride which must be dried in an oven at 200° C for a minimum of 1 hour, and must be allowed to lose its heat before use, this results in a

relative humidity of 0%. Past ruggedness studies show that for the area being tested 200g of desiccant is the most efficient quantity for these tests.

Tests can vary depending on the desired relative humidity on the solution side. Many different solutions can allow for many different relative humidities. To date three solutions have been used:

- 100%
- 75%
- 52%

When testing 100% distilled water was placed in the solution cup and an air space of 25 mm was left between the specimen and the solution, this was due to the fact that when moved the specimen could have been splashed by the water causing errors in the testing. In addition to increasing the air space cotton was added to limit the water movement in the cup. When using 75% relative humidity table salt was used along with distilled water, in order to assure proper saturation of the water table salt was added until a significant quantity of salt grains could be seen at the bottom of the solution. In this case cotton was also added to reduce splashing and a 25 mm air space was also used. For testing at 52% relative humidity magnesium nitrate was used, in order to acquire the desired relative humidity the magnesium nitrate was added to water until a slurry was achieved, the air space was kept at 25 mm to create proper consistency throughout the testing.

Once the specimen has been prepared, the solution mixed and the desiccant dried, the testing commenced. All three components were weighed and noted separately before the test begins. The specimen was placed on top of the solution cup facing the desired

relative humidity. The desiccant cup was then placed on top of the specimen and the compression rods are placed and tightened to ensure air tightness. The test was left untouched for 48 hours, then the three components were separated and weighed individually. The used desiccant was removed and replaced by new desiccant, which had been properly dried. The test continued and the desiccant was changed every 48 hours until steady state was achieved. Steady state varied depending on the type of specimen being tested. Each time the desiccant was changed measurements were taken as well as recording the date, time, and room conditions.

The difference in weight was calculated in grams and divided by the elapsed time in seconds and area of the specimen resulting in the weight change quantity relative to time and area. The results were then calculated into $\text{kg}/\text{Pa}\cdot\text{s}\cdot\text{m}^2$. When using different solutions the air pressure was based on temperature and divided by the relative humidity being used, thus for 75% the number was multiplied by 0.75. The resistance was acquired by calculating $1/\text{permeance}$, which is $\text{Pa}\cdot\text{s}\cdot\text{m}^2/\text{kg}$. These calculations can be done in order to acquire resistance and permeance for both the water side as well as the desiccant side.

3.1.1. Ruggedness study for double cup method

The purpose of conducting a ruggedness study is to determine possible factors affecting or influencing test results. Questionable factors can be determined and tested in order to confirm which factors should be used or to what degree they should be controlled for the test method. A ruggedness study is a necessity for most newly developed test methods since it can help in determining the test methods accuracy. A ruggedness study does not however determine the optimum test conditions. The

ruggedness study used in this series of tests is based on ASTM E 1169-87, “Standard guide for conducting ruggedness tests” which, follow the “Plackett-Burman” designs. While being limited to two levels per variables, they are easy to apply and efficient when evaluating most test methods.

The ruggedness study set-up consists of determining high and low ranges for each factor in question. The high ranges are illustrated as + and the low ranges are illustrated by -. The factors vary from test to test and are typically determined by the test developer. Since it has been proven that cellulose membranes are most affected by variations in R.H. levels, the tests were all performed on those materials. The table set-up for this study is as follows:

Table 3.1: General ruggedness study set-up.

Ruggedness study					
Set-up	1	2	3	4	5
1	-	-	+	-	+
2	-	+	-	+	+
3	+	-	+	+	-
4	+	+	-	-	-

Table 3.2: Ruggedness study set-up for double cup test method.

Ruggedness study for Double Cup Test Method					
Set-up	Desiccant Change (D)	Still air layer	Specimen condition	Area	Wet Cup condition
	1	2	3	4	5
1	- 1 Day	- 5mm	+ Wet	- 100 mm (4")	+ 100%
2	- 1 Day	+ 25mm	- Dry	+ 130mm (5")	+ 100%
3	+ 2 Days	- 5mm	+ Wet	+ 130mm (5")	- 52%
4	+ 2 Days	+ 25mm	- Dry	- 100mm (4")	- 52%

- Desiccant change: The desiccant used in this test method is calcium chloride and is considered solid absorptive desiccant, this factor is significant since the moisture transmission will decrease as the saturation of the desiccant increases. The high range is set at 2 days elapsed before the desiccant is changed and the low range is set at 1 day.

- Still air layer: The still air layer is the air space between the desiccant and the specimen, it has been proven that in some cases the still air layer can have an effect on water vapour transmission, by having a low and high range of the still air layer its significance on this test method can be determined. The high range is set at 25 mm still air layer and the low range is set at 5 mm.
- Specimen condition: In tests similar to this test method the specimen is dry throughout the testing process. However, in some on site cases materials are subjected to rain during construction, it is important to determine if the test is affected by the specimen being wet or dry before testing. The high range is set at a wet specimen before testing and the low range is set at a dry specimen.
- Area: The area of the specimen can be an important factor in testing since an increase in area may be relative to the increase in transmission. The high range is set at 130 mm specimen diameter and the low range is set at 100 mm in diameter.
- Wet cup condition: This test method is intended to be used with varying relative humidity if deemed necessary, it is important to determine the effects of a difference in relative humidity. The high range is set at 100% relative humidity and the low range is set at 52%.

3.1.2. Results and analysis

For each factor the average is calculated as the sum of the positive values (+) over 2 (number of values), then the sum of the negative values (-) over 2 (number of values). Then the positive values (+) are subtracted from the negative values (-) to give what is called the “Effect”. The equation is as follows:

$$Effect = \left(\frac{2}{N} \right) \left[\sum (+) - \sum (-) \right]$$

The tests are performed on two (or more) identical set-ups and the second data set is calculated the same as the first. The Effects from both sets of data are subtracted from one another and the difference between the two effects can be determined as well as the average of the two effects. The variance of d must then be determined where the sum of all the values of d² are divided by the number of factors in the test. Once this is executed then the t-value can be calculated using:

$$t - value = \frac{\text{average effect}}{\frac{2\sqrt{\text{Variance of (d)}}}{\sqrt{16}}}$$

In this case the ruggedness study can be evaluated in three different ways due to the fact that two sets of values are produced when performing this test, first the values from the wet and dry cups respectively and can be analysed, also the values from the averages of the two factors can be evaluated. The first to analyse is that of the desiccant side values.

Table 3.3 : Ruggedness study for DC method desiccant side.

Ruggedness study for double cup desiccant side										
Factor	Level High Low (+) or (-)	Set-up 1		Set-up 2		Difference of effects (d)	Average of effects	(d) ²	t-value (Absolute)	
		Average Resistance (kg/Pa s m)	Effect	Average Resistance (kg/Pa s m)	Effect					
1	2 days	2.32E+07		2.20E+07						
1	1 day	1.35E+07	9.72E+06	1.54E+07	6.63E+06	-3.09E+06	8.18E+06	9.53E+12	5.76	
2	25mm-SAL	2.24E+07		2.42E+07						
2	5mm-SAL	1.44E+07	7.98E+06	1.33E+07	1.09E+07	2.91E+06	9.43E+06	8.49E+12	6.64	
3	Wet	1.44E+07		1.33E+07						
3	Dry	2.24E+07	-7.98E+06	2.42E+07	-1.09E+07	-2.91E+06	-9.43E+06	8.49E+12	6.64	
4	130mm	1.87E+07		1.80E+07						
4	100mm	1.80E+07	7.03E+05	1.94E+07	-1.37E+06	-2.07E+06	-3.31E+05	4.28E+12	0.23	
5	100%	1.35E+07		1.54E+07						
5	52%	2.32E+07	-9.72E+06	2.20E+07	-6.63E+06	3.09E+06	-8.18E+06	9.53E+12	5.76	
								Variance (d)	8.06E+12	

The standard statistical factor to be used when analysing ruggedness values relative to the t-values with 95% confidence and 5 degrees of freedom is 2.015, therefore any value above 2.015 is deemed as a factor affecting the test results. In this case four factors were proven to be significant.

Since there are two sources of measurement the wet cup results can be evaluated as well as the averages of the wet cup and dry cup values, in all cases the results agree with one another.

Table 3.4: Ruggedness study for DC method solution side.

Ruggedness study for double cup solution side									
Factor	Level High Low (+) or (-)	Set-up 1		Set-up 2		Difference of effects (d)	Average of effects	(d)2	t-value (Absolute)
		Average Resistance (kg/Pa s m)	Effect	Average Resistance (kg/Pa s m)	Effect				
1	2 days	1.90E+07		1.80E+07					
1	1 day	1.27E+07	6.26E+06	1.17E+07	6.36E+06	9.67E+04	6.31E+06	9.35E+09	9.92
2	25mm-SAL	1.89E+07		1.84E+07					
2	5mm-SAL	1.28E+07	6.11E+06	1.12E+07	7.18E+06	1.07E+06	6.65E+06	1.15E+12	10.44
3	Wet	1.28E+07		1.12E+07					
3	Dry	1.89E+07	-6.11E+06	1.84E+07	-7.18E+06	-1.07E+06	-6.65E+06	1.15E+12	10.44
4	130mm	1.58E+07		1.60E+07					
4	100mm	1.59E+07	-9.58E+04	1.37E+07	2.31E+06	2.41E+06	1.11E+06	5.79E+12	1.74
5	100%	1.27E+07		1.17E+07					
5	52%	1.90E+07	-6.26E+06	1.80E+07	-6.36E+06	-9.67E+04	-6.31E+06	9.35E+09	9.92
								Variance (d)	1.62E+12

Table 3.5: Ruggedness study for DC method comparison of solution and desiccant sides.

Ruggedness study for double cup both sides									
Factor	Level High Low (+) or (-)	Set-up 1		Set-up 2		Difference of effects (d)	Average of effects	(d)2	t-value (Absolute)
		Average Resistance (kg/Pa s m)	Effect	Average Resistance (kg/Pa s m)	Effect				
1	2 days	1.86E+07		2.26E+07					
1	1 day	1.50E+07	3.60E+06	1.45E+07	8.18E+06	4.58E+06	5.89E+06	2.10E+13	3.90
2	25mm-SAL	2.13E+07		2.33E+07					
2	5mm-SAL	1.24E+07	8.92E+06	1.38E+07	9.43E+06	5.09E+05	9.18E+06	2.59E+11	6.08
3	Wet	1.24E+07		1.38E+07					
3	Dry	2.13E+07	-8.92E+06	2.33E+07	-9.43E+06	-5.09E+05	-9.18E+06	2.59E+11	6.08
4	130mm	1.58E+07		1.84E+07					
4	100mm	1.79E+07	-2.11E+06	1.87E+07	-3.31E+05	1.78E+06	-1.22E+06	3.15E+12	0.81
5	100%	1.50E+07		1.45E+07					
5	52%	1.86E+07	-3.60E+06	2.26E+07	-8.18E+06	-4.58E+06	-5.89E+06	2.10E+13	3.90
								Variance (d)	9.11E+12

The t-values are all in agreement with one another and the factors of significance can now be evaluated.

- Desiccant change factor: This factor is referenced in the ASTM E-96 where the desiccant should not be allowed to increase more than 10% water content. Also the standard indicates that this factor cannot be exactly determined and is an area where the operators judgment is deemed necessary. It can be determined that in order to be cautious the desiccant can be changed every day, however since this is a closed system (unlike the ASTM E-96-00) the frequent opening and closing of the system may be influenced by possible temperature and relative humidity oscillations, since the weighing is not performed within the chamber. Also, the affects of the barometric pressure changes may be the cause of the influence of the effect. Due to the fact that the weighing is not performed within the temperature chamber the tests should be changed every two days.
- Still air layer: this factor had proven to be complex in determining and will be further discussed in the next chapter
- Specimen condition before testing: Since the test method is based on water vapour transfer its intent is to focus on dry materials.
- Wet cup contents: This test is useful at determining the transmission rates at different relative humidity levels, thus it was important for this factor to have a significant effect on the test method.

The only factor of no significance is that of the area, thus, enabling the operator to perform the testing based on availability of materials, since apparatus size may vary.

3.2 Modified inverted cup test method

This test method consists of a modified inverted cup system, which includes a moisture source, a membrane and a moisture sink developed by Pazera (2003). The experiment is set up in a manner that water vapour transmission can occur through the membrane and be absorbed by the moisture sink. This test method is similar to the test method known as dry cup. The purpose of using a water head is to eliminate the presence of a still air layer on one side of the specimen. The test allows for determination of the maximum possible water vapour transmission.

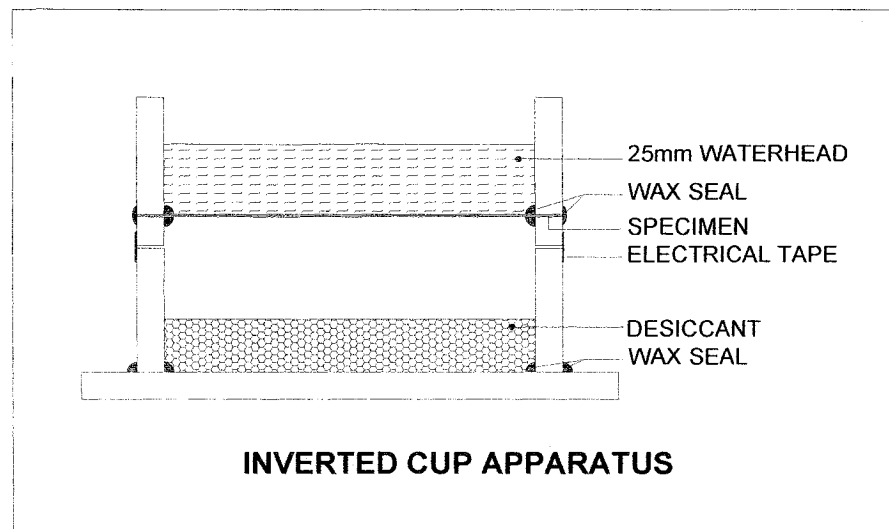

Figure 3.3: Modified inverted cup test apparatus.

The test specimen is cut to the size of the test ring its weight and its thickness recorded it is then waxed to the perimeter of the inside of the ring. The wax mixture is 50% paraffin wax and 50% rosin. The lower ring is placed on the underside of the specimen and wax is also placed around the perimeter. The two rings are then waxed on the outside joint to resist room conditions. The test rings consist of ABS pipe 100 mm in diameter and 2 are 190 mm in height and one is 25 mm in height. One ring is connected to a flat surfaced bottom with the wax mixture on the inside and outside perimeter.

The desiccant used is calcium chloride which is dried in an oven at 200° C for 1 hour and is left to cool before use. The two assemblies weight must be recorded before testing. 200g of dried desiccant is placed inside the lower cup and the assembly weighed, the upper portion of the apparatus is placed above the lower portion and is held in place with a high quality electrical tape, which is placed twice around the set-up.

The test is left untouched for 48 hours, then the water is removed and the specimen is gently wiped to remove any excess water. The electrical tape is removed and the two components are separated and weighed individually. The used desiccant is removed and replaced by new desiccant. The electrical tape is replaced and the test continued the desiccant being changed every 48 hours until steady state is achieved. Steady state may vary depending on the type of specimen being tested.

Each time the desiccant is changed measurements must be taken as well as the date, time, and room conditions. The weight change is calculated in the same manner as the double cup method.

3.2.1. Ruggedness study for modified inverted cup method

For the modified inverted cup test method the ruggedness study set-up was as follows:

Table 3.6: Ruggedness study set-up for modified inverted cup test method.

Ruggedness study for Modified Inverted Cup Test Method					
Set-up	Desiccant Change (D)	Water Head	Still air layer	Area	Specimen condition
	1	2	3	4	5
1	- 1 Day	- 5mm	+ 25mm	+ 100 mm (4")	+ Wet
2	- 1 Day	+ 25mm	- 5mm	- 90mm (3.5")	+ Wet
3	+ 2 Days	- 5mm	+ 25mm	- 90mm (3.5")	- Dry
4	+ 2 Days	+ 25mm	- 5mm	+ 100mm (4")	- Dry

- Desiccant change: The desiccant used in this test method is calcium chloride and is considered solid absorptive desiccant, this factor is significant since the moisture

transmission will decrease as the saturation of the desiccant increases. The high range is set at 2 days elapsed before the desiccant is changed and the low range is set at 1 day.

- **Water head:** Although in some cases the water head level causing hydrostatic pressure has proven to be insignificant, unless a large water head is present, it may prove to be an important factor in testing. The high range is set at 25 mm and low range is set at 5 mm.
- **Still air layer:** The still air layer is the air space between the desiccant and the specimen, it has been proven that in some cases the still air layer can have an effect on water vapour transmission, by having a low and high range of the still air layer its significance on this test method can be determined. The high range is set at 25 mm still air layer and the low range is set at 5 mm.
- **Area:** The area of the specimen can be an important factor in testing since an increase in area may be relative to the increase in transmission. The high range is set at 100 mm specimen diameter and the low range is set at 90 mm in diameter.
- **Specimen condition before testing:** In tests similar to this test method the specimen is dry throughout the testing process. However, in some on site cases materials are subjected to rain during construction, it is important to determine if the test is affected by the specimen being wet or dry before testing. The high range is set at a wet specimen before testing and the low range is set at a dry specimen.

3.2.2. Results and analysis

The modified inverted cup test method produces only one set of results unlike that of the double cup test method, therefore the ruggedness study can have only one table of evaluations.

Table 3.7: Ruggedness study set-up for modified inverted cup test method.

Ruggedness study for modified inverted cup									
Factor	Level High Low (+) or (-)	Set-up 1		Set-up 2		Difference of effects (d)	Average of effects	(d) ²	t-value (Absolute)
		Average Resistance (kg/Pa s m)	Effect	Average Resistance (kg/Pa s m)	Effect				
1	2 days	4.42E+08		4.80E+08					
1	1 day	3.53E+08	8.92E+07	4.31E+08	4.92E+07	-3.99E+07	6.92E+07	3.98E+14	2.74
2	25mm-WH	3.74E+08		4.25E+08					
2	5mm-WH	4.22E+08	-4.78E+07	4.86E+08	-6.14E+07	-1.35E+07	-5.46E+07	1.83E+14	2.16
3	25mm-SAL	4.22E+08		4.86E+08					
3	5mm-SAL	3.74E+08	4.78E+07	4.25E+08	6.14E+07	1.35E+07	5.46E+07	1.83E+14	2.16
4	96mm	3.83E+08		4.92E+08					
4	46mm	4.12E+08	-2.85E+07	4.19E+08	7.36E+07	1.02E+08	2.25E+07	1.04E+16	0.89
5	Wet	3.53E+08		4.31E+08					
5	Dry	4.42E+08	-8.92E+07	4.80E+08	-4.92E+07	3.99E+07	-6.92E+07	1.59E+15	2.74
								Variance (d)	2.56E+15

These results show that four factors are significant in this test method they consist of:

- Desiccant change factor: This factor is referenced in the ASTM E-96 where the desiccant should not be allowed to increase more than 10% water content. This requirement is related to the dry cup test method and due to the lack of documentation in regard to this test method the requirements can be applied in this case. Also the standard indicates that this factor cannot be exactly determined and is an area where the operator's judgment is deemed necessary.
- Water head: The level of the water head has proven significant due to hydrostatic pressure, the main purpose of this test method is to eliminate the still air layer on one side of the material, any unnecessary additional pressure may be harmful when

analysing results, thus a 5 mm water head is efficient, anything lower could have the potential to evaporate and cause increased uncertainty in the results.

- Still air layer: this factor had proven to be complex in determining and will be further discussed in the next chapter.
- Specimen condition before testing: Since the ruggedness study is based on all recorded measurements the specimen's condition has proven to be a factor. When the test is conducted for usable results only values from steady state are analysed, thus the time period from when the dry material is dry to when it is saturated is not a factor when steady state results are evaluated.

The factor of insignificance is that of the area of the specimen.

Chapter 4

Corrections for surface resistance and still air layer

Double cup tests were performed on multiple layers. In many cases the conditions of the tests varied to examine the effect of relative humidity or the temperature oscillation during the test. The main focus of this research was to determine a joint effect of the still air layer and the surface resistance (SAL+SR) since separating them is quite difficult. The linear fit to the multiple specimen layers was extended to zero layers to determine the value of the intercept. Type P (polymeric fiber-membranes) were selected for the primary study since this type of material has been proven to have water vapour permeance constant over the RH range.

4.1 Calculations

One must first calculate the water vapour transmission (WVT) as per equation (16). Yet, to examine different components of water vapour permeance one must use the inverse of WVP namely the resistance to water vapour flow (WVR), which can be determined as $1/\text{permeance}$.

4.2 Double cup (DC) test method applied to type P products

Tests were performed using the double cup methods as discussed in chapter 3. Four types of materials were evaluated falling into the two categories of polymeric membranes (P), and cellulose membranes (C). Table 4.1 shows all measurements performed on type P (polymeric) product P8.

Table 4.1: Intercept values obtained with different DC tests performed on products P6 and P8

Specimen	Wet cup Solution	Temp control + - °C	Intercept Solution Side	Intercept Desiccant Side	Mean	Standard Deviation
8	52%	2.5	8.00E+08	8.84E+08	8.42E+08	5.94E+07
8	75%	1.5	4.75E+08	5.67E+08	5.21E+08	6.51E+07
8	75%	2.5	7.00E+08	7.01E+08	7.01E+08	7.07E+05
8	100%	2.5	5.79E+08	5.74E+08	5.77E+08	3.54E+06
6	52%	2.5	8.47E+08	7.72E+08	8.10E+08	5.30E+07

Table 4.1 shows that the precision of the test is acceptable because for membrane P8 the values measured on both water and desiccant side are close to one another (see Figure 4.1, sides 1 & 2 represent the two different values for 75%). For P6 membrane the agreement between water and desiccant sides is also acceptable.

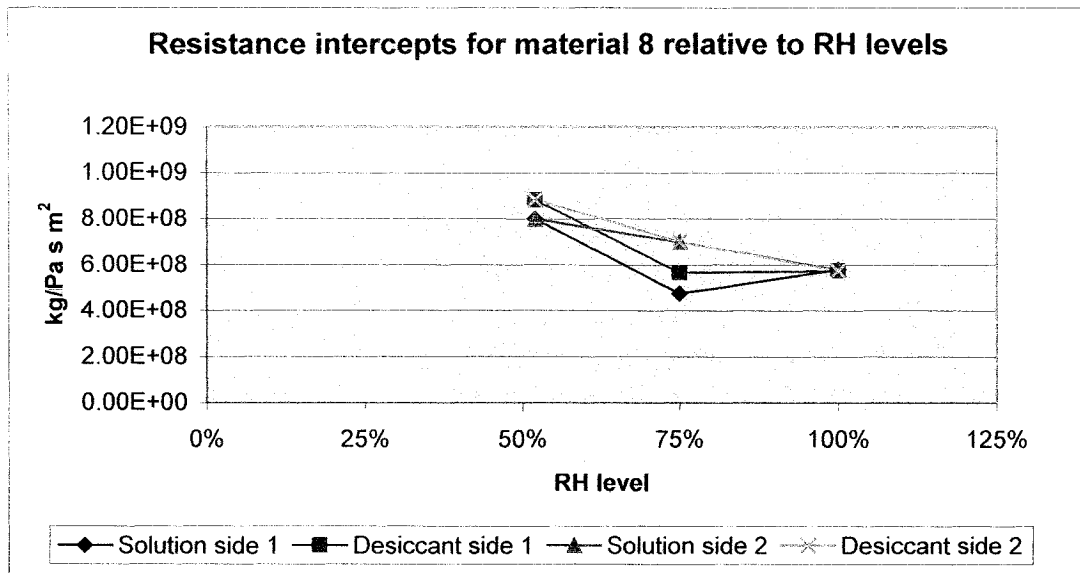

Figure 4.1: Intercept values for P8 product obtained with the DC method.

The mean value of intercept for type P products was 6.9E+08 and the standard deviation of 1.4E08. Since there were 5 measurements, for 95% confidence interval from the statistical table and 4 degree of freedom a multiplier of 2.78E08 was determined and the

uncertainly range became 3.9E08. The intercept was determined as 6.9E08 plus or minus 3.9E08.

4.3. Modified inverted cup (MIC) test method applied to type P products

The modified inverted cup tests with a 25-mm thick air layer were also performed on the aforementioned materials and intercepts were obtained in the same manner.

Table 4.2: Intercepts for the tested materials using the MIC test method.

Specimen	Temp control + - °C	Intercept Desiccant Side
P6	2	9.12E+08
P6	1	9.01E+08
P8	2	1.17E+09
P8	1	9.71E+08

The values are all close in range and the average intercept from 4 MIC measurements is 9.89E08 and the standard deviation of 1.25E08. Since there were 4 measurements for 95% confidence interval from the statistical table and 5 degree of freedom a multiplier of 3.18E08 was determined and the uncertainly range became 3.97E08. The intercept was determined as 9.89E08 plus or minus an uncertainty of 3.97E08.

4.4 Double cup (DC) test method applied to type C products

Three tests series were performed on product C5 and one on product C4 (Table 4.3).

Table 4.3: Intercepts determined for products C4 and C5.

Specimen	Wet cup Solution	Temp control + - °C	Intercept Solution Side	Intercept Desiccant Side	Mean	Standard Deviation
C5	52%	2.5	7.12E+08	7.69E+08	7.41E+08	4.03E+07
C5	75%	2.5	9.74E+08	1.08E+09	1.03E+09	7.50E+07
C5	100%	2.5	8.84E+08	7.21E+08	8.03E+08	1.15E+08
C4	52%	2.5	5.13E+09	4.61E+09	2.85E+09	2.62E+08

Table 4.3 shows that intercept measured for product C4 is much different than those measured for product C5. For 3 measurements on product C5 one obtains an

average intercept of 8.6E08 and the standard deviation of 1.5E08. For 95% confidence interval from the statistical table and 3 degree of freedom a multiplier of 4.3E08 was implemented and the uncertainly range became 6.5E08. Thus, the maximum probable intercept is 8.6E08 plus 6.5 E08, much less than one measured for product C4. We must treat this measurement as a statistical outlier, thus not within an acceptable range of the other values.

4.5. Modified inverted cup (MIC) test method applied to type C products

Two measurements performed on product C5 yield intercepts of 7.25E08 and 6.35E08 i.e., in the range of probable results.

4.6. Discussion on intercepts obtained from different WVT tests on various products

Table 4.4 lists all measured values of intercept from both double cup and modified inverted cup measurements and Figure 4.2 shows them graphically to highlight that no systematic trend can be observed.

Table 4.4: The mean values (from both desiccant and solution sides) measured with the DC method and the desiccant side values for the MIC method.

Method	Temperature Control +/- °C	Cup Solution RH	Material		
			C	P	
			5	6	8
DC	2.5	52%	7.41E+08	8.10E+08	8.42E+08
	1.5	75%	-	-	5.21E+08
	2.5	75%	1.03E+09	-	7.01E+08
	2.5	100%	8.03E+08	-	5.77E+08
MIC	1.5	100%	6.53E+08	9.01E+08	9.71E+08
	2	100%	7.25E+08	9.12E+08	1.17E+09

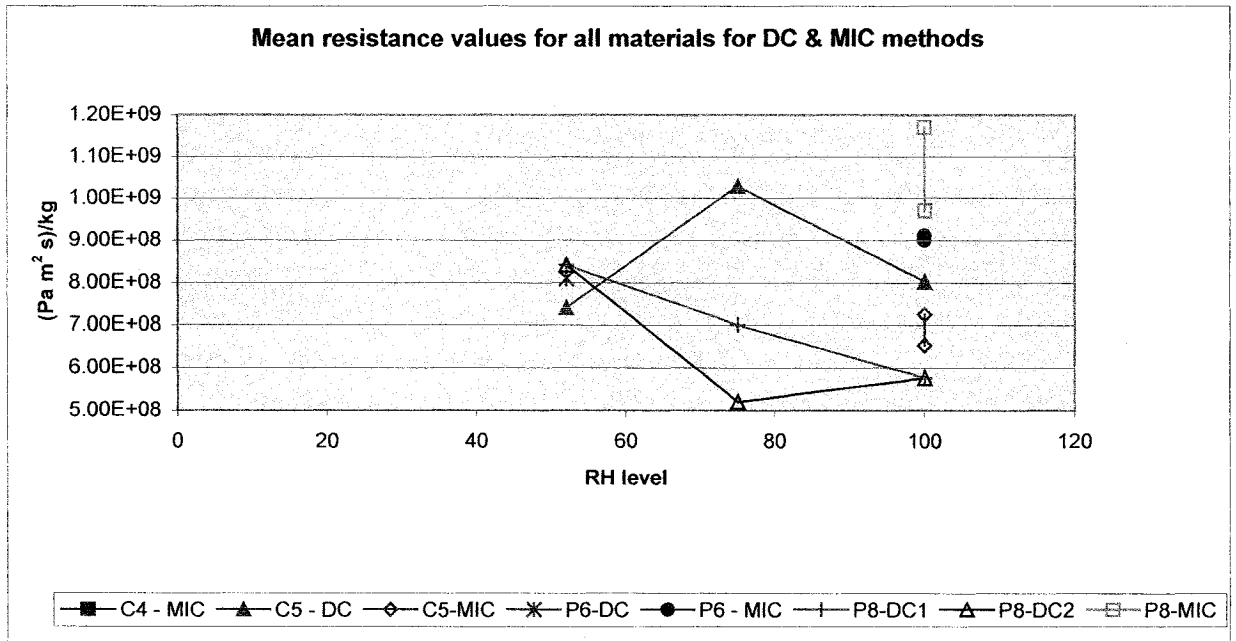

Figure 4.2: Intercept mean of materials C5, P6, and P8 measured with both DC and MIC methods.

Figure 4.2 highlights the relative errors in measurements performed at 52% RH which appear to be much smaller than those obtained at 75 %RH or 100 %RH. Surprisingly enough, the scatter of MIC test method where only one surface resistance is included appears even larger than that of double cup measurements.

The mean value of intercepts measured at 52 %RH is 7.98E08 and the mean value of all DC measurements is 7.53E08, MIC measurements is 8.89E08, the total mean value for both test methods is 8.11E08 with a standard deviation of 1.78E08. There are 14 measurements and 95% confidence with 14 degrees of freedom, the multiplier becomes 2.145, which gives the uncertainty of plus or minus 3.8E08. One may compare the measured values with those measured by Burch, Thomas & Fanney (1992).

Table 4.5 Intercept data obtained by Burch and Thomas (1992).

Cup No.	R.H.		Air layer Resistance (Pa s m ² /kg)	
	Cup	Vessel	24°C	7°C
1	11.27	23.2	4.87E+08	5.76E+08
2	33.56	43.13	5.23E+08	4.69E+08
3	63.06	72.89	7.58E+08	5.55E+08
4	75.65	87.36	4.27E+08	5.23E+08
5	91.76	98.38	4.39E+08	4.40E+08

The same conclusion may be reached about the random character of intercept over the full range of relative humidity measurements. The mean value of all measurements performed at 24 °C is 5.27E08.

Finally the results of this work can be compared with the resistance of the still air layer alone. Typically, the resistance of SAL is determined from Schirmer's equation (1938), which describes diffusion of water vapour in still air as per equation (12). The German standard DIN 52615 (1987), applies Schirmer's equation as per equation (13). By applying the ASTM E-96-03 calculation method equation (29) to the test method conditions used here, one obtains the WV permeability of 1m of still air layer 1.99E-10, for a still air layer of 25mm the resistance is 1.25E08.

The ASTM E96-03 also takes into consideration the surface resistance of the material based on research reported by Hansen and Lund (1990). It is assumed as constant 0.4E08 and is added to give a total resistance of 1.57E08 for a 25mm air layer. Table 4.6 summarizes all intercept data obtained here and in other known work.

Table 4.6 Intercept data obtained from different sources for 25-mm thick air layer, Babbitt thickness unknown.

Source	Description	Resistance
Own work	14 measurements, 52%, 75%, and 100% RH, mean value	8.11E+08
Own work	3 measurements at 52% RH, mean value	7.98E+08
Literature	Burch and Thomas (1992), mean value	5.27E+08
Literature	Babbitt (1939)	3.76E+08
ASTM	SAL-Schirmer	1.17E+08
ASTM	Total of SAL and SR values, calculated	1.57E+08

Table 4.6 permits drawing a few conclusions on the effect of still air layer and the surface resistance. First of all one may assume that diffusion of water vapour through the still air layer does not change in the range of 10 – 25 mm typically used in the cup methods. Secondly, one may assume that this process is approximated with the Schirmer equation to a satisfactory degree of precision. One may therefore separate the effect of still air layer and surface resistance by subtracting the SAL resistance from the total intercept measured. The results are shown in Table 4.7.

Table 4.7 Surface resistance calculated from the total intercept values.

Source	Description	Surface Resistance
Own work	14 measurements, 52%, 75%, and 100% RH, mean value	6.94E+08
Literature	Burch and Thomas (1992)	5.10E+08
Literature	Babbitt (1939)	3.76E+08
ASTM	Hansen & Lund (1990)	4.00E+07

Table 4.7 indicates that surface resistance is material dependent and that values used by ASTM may be one magnitude lower than those determined for WRB products. Thus, the fact that the ASTM E-96-03 uses a constant value for the surface resistance based on research performed by Hansen and Lund (1990) is not an ideal application. First, because as shown here, each material has the potential to cause a variation in the surface resistance. Second, equation (26) developed by Hansen and Lund (1990) utilizes either measurements for the surface diffusion resistances, which are not described, or if unavailable can be determined through the use of Lewis' law. This law has caused much controversy in the area of quantum physics to date and many sources have deemed it to be unappropriate for scientific use. Thus if ASTM-E-96-03 has determined the constant used through the use of Lewis' law then the method of calculation is strongly questionable.

There are a few reasons for it. First, equation (19) developed by Hansen and Lund (1990) utilizes either measurements for the surface diffusion resistances, which are not described, or those that can be determined from Lewis' law. While this law assumes a full correspondence between heat and mass film transfer coefficients, one typically assumes a difference between mass transfer coefficient when moisture content of the material is above the critical moisture content for drying (division between the first and the second stage of the drying rate) and when moisture content is below this characteristic point of drying rate.

Second, experimental results of Burch and Thomas (1992) show that the surface resistance in their measurements is much higher than that determined by Lund and Hansen (1990).

Third, experimental results of Burch and Thomas (1992) indicated a dependence of the surface resistance on the RH level. This work (Table 4.7) shows that while so far all measured surface resistance data does not have sufficient precision to support or reject this statement, the surface resistance is, however, affected by the nature of tested material.

Chapter 5: Results of the WVP measurements and discussion

The mean value of the intercept determined in chapter 4 was subtracted from the measured resistance of the single layer, and compared with the results calculated for the measured difference between one and two layers calculated from the linear regression on multiple layers.

5.1. Type P products.

The water vapour permeance of P type products is not expected to vary with the relative humidity, thus we will analyze these results first.

Table 5.1 Resistance to water vapour flow measured on single layer of type P products with corrections from individual measured intercepts as well as corrections from mean intercept value, all values in Pa·s·m²/kg.

Material	RH wet side	Apparent WVR	Measured Intercept	Corrected w/intercept	Corrected w/ mean	% difference
P6	52	9.64E08	8.10E08	1.55E08	1.53E08	1.3
P6	75	1.10E09	N/A	N/A	2.99E08	N/A
P6	100	1.33E09	N/A	N/A	5.19E08	N/A
MIC P6	100	1.25E09	9.12E08	3.38E08	4.39E08	29.9
MIC P6	100	1.23E09	9.01E08	3.29E08	4.19E08	27.4
P8	52	1.16E09	8.42E08	3.18E08	3.49E08	9.7
P8	75	1.05E09	7.01E08	3.49E08	2.39E08	31.5
P8	75	1.41E09	5.21E08	8.89E08	5.99E08	32.6
P8	100	1.03E09	5.77E08	4.53E08	2.19E08	51.7
MIC P8	100	1.58E09	1.17E09	4.10E08	7.69E08	87.6
MIC P8	100	1.44E09	9.71E08	4.69E08	6.29E08	34.1

One measurement performed at 75 %RH (corrected with the measured intercept, of 8.89E08) is a statistical outlier. The mean of the corrected intercept values remaining (5 measurements) performed on product P8 is 4.0E08, and the standard deviation is 6.52E07. For 4 degrees of freedom one has an uncertainty range of 1.81E08 implying

that for product P8, with the probability of 95%, thus the maximum water vapour resistance is 5.81E08 (Pa·s·m²/kg).

Table 5.1 shows that the corrected values of water vapour resistance are two or three times lower than those measured without any correction (apparent WV permeance). Even if an ASTM correction is applied this difference would still be more than two times the measured values.

Table 5.2 Water vapour permeance as measured (apparent) and that based on intercept correction in metric and British systems (perms).

Material	RH on wet side	Apparent WV Permeance kg/(Pa s m ²)	Water vapour Permeance kg/(Pa s m ²)	Water vapour permeance perms
P6	52	1.03E-09	6.45E-09	113
P6	75	9.81E-10	N/A	N/A
P6	100	7.50E-10	N/A	N/A
MIC P6	100	8.00E-10	2.95E-09	51
MIC P6	100	8.13E-10	3.04E-09	53
P8	52	8.62E-10	3.14E-09	55
P8	75	9.52E-10	2.87E-09	50
P8	75	7.09E-10	N/A	N/A
P8	100	9.70E-10	2.21E-09	39
MIC P8	100	6.33E-10	2.44E-09	43
MIC P8	100	6.94E-10	2.13E-09	37

This work shows that the significance of the surface resistance cannot be neglected even for this type of membranes. While results obtained with 52% RH show much smaller differences between two examined approaches (Tables 5.1 and 5.2), yet repeated test on product P6 (compare Table 5.1. with 52) do not indicate sufficient precision of the method.

5.2. Type C products.

The water vapour permeance of these products is expected to increase with the relative humidity.

Table 5.3 Resistance to water vapour flow measured on single layer of type C product with corrections from individual measured intercepts as well as corrections from mean intercept value, all values in Pa·s·m²/kg.

Material	RH wet	Apparent WVR	Measured Intercept	Corrected w/intercept	Corrected w/ mean	% difference
C5	52	1.76E09	7.41E08	1.02E09	9.49E08	7
C5	75	1.45E09	1.03E09	4.15E08	6.31E08	52
C5	100	1.61E09	8.03E08	8.05E08	7.96E08	1
MIC C5	100	1.23E09	7.25E08	5.05E08	4.19E08	17
MIC C5	100	1.29E09	6.35E08	6.55E08	4.79E08	27

The results shown in Table 5.3 may now be recalculated into water vapour permeance, which is more commonly used when evaluating these types of materials.

Table 5.4 Water vapour permeance as measured (apparent) and that based on intercept correction in metric and British systems (perms).

Material	RH on wet side	Apparent WV Permeance kg/(Pa s m ²)	Water vapour Permeance kg/(Pa s m ²)	Water vapour permeance perms
C5	52	5.68E-10	0.980E-09	17
C5	75	6.89E-10	2.41E-09	42
C5	100	8.61E-10	1.24E-09	22
MIC C5	100	0.81E-10	1.98E-09	34
MIC C5	100	7.75E-10	1.53E-09	27

Table 5.3 shows that the corrected values of water vapour resistance are about two times lower than those measured without any correction (apparent water vapour permeance). Even if an ASTM correction is applied this difference would still be close to a double of the measured values. In other words, the significance of surface resistance cannot be neglected for this type of membranes.

Table 5.4 shows an apparent water vapour permeance measurements for type C products, increasing from $5.68\text{E-}10$ kg/(m²sPa), through $6.89\text{E-}10$ kg/(m²sPa) to $8.61\text{E-}10$ kg/(m²sPa) for 52, 75, and 100%RH respectively. Yet, after introducing the intercept correction the permeance at 75 % RH [$2.41\text{E-}09$ kg/(m²sPa)], exceeds the measurements at 52% RH and 100 %RH. It appears that unless the temperature oscillation in the room is significantly reduced the intercept correction may not be the preferred manner of correcting for surface resistance.

This also explains the differences in the DC method results compared to those of the MIC method, in some cases the values from the MIC method are higher than the DC method and in other cases it is the inverse. This research shows that the temperature oscillations have proven to be a significant factor for type C WRB products.

Chapter 6: Conclusions

The measurements reported in this work were performed in conditions expected in a typical manufacturing situation (large conditioned space in which the laboratory space is poorly controlled). The objective was to examine limitations of the double cup method, realizing that standard WVT testing requires much better temperature and humidity control.

Because of the assumed conditions of large and poorly controlled space, some of these measurements were found beyond the probable range of statistically determined uncertainty. For instance, the intercept of multi-layered tests was found to be a statistical outlier, yet the measured values of this product fall within a probable range of results. Similarly, even though the intercept measured on product P8 was within a probable range, the corrected value of water vapour resistance for product P8 clearly fall outside the probable range.

The focus in this research was on the determination of the effect of still air layer and the surface resistance. As it is not possible to separate these two sources of resistance to water vapor flow, one may assume that diffusion of water vapour through still air layer does not change in the range of 10 – 25 mm typically used in the cup methods. This process may be approximated as diffusion of water vapour through still air, by using Schirmer's equation, to a satisfactory degree of precision. When subtracting the resistance of the still air layer from the total resistance measured by the intercept in a multi-layered configuration, the remaining part of the resistance is therefore ascribed to the surface resistance.

The results shown in Table 4.7 indicate that surface resistance depends on the tested material. The values used by ASTM [$0.4E08 \text{ (m}^2\text{s Pa)/kg}$] is one magnitude lower than those determined for WRB products in this work [$6.94E08 \text{ (m}^2\text{s Pa)/kg}$]. Thus, the fact that the ASTM E-96-03 uses a constant value for the surface resistance based on research performed by Hansen and Lund (1990) is questionable.

There are a few reasons for it, first equation (26) developed by Hansen and Lund (1990) utilizes either measurements for the surface diffusion resistances, which are not described, or those that can be determined from Lewis' law. While this law assumes a full correspondence between heat and mass film transfer coefficients, one typically assumes a difference between mass transfer coefficient when moisture content of the material is above the critical moisture content for drying (division between the first and the second stage of the drying rate) and when moisture content is below this characteristic point of drying rate.

Second, experimental results of Burch and Thomas (1992) show that the surface resistance in their measurements is much higher than that determined by Lund and Hansen (1990).

Third, experimental results of Burch and Thomas (1992) indicated a dependence of the surface resistance on the RH level. This work (Table 4.7) shows that while all so far measured surface resistance data do not have sufficient precision to support or reject this statement, the surface resistance is, however, affected by the nature of tested material.

Since the water vapour permeance of P type products is not expected to vary with the relative humidity, multiple tests performed on these materials may be used to assess

precision of the test method. This work shows that the significance of the surface resistance cannot be neglected even for this type of membranes. While results obtained with 52% RH show much smaller differences between two examined approaches (Tables 5.1 and 5.2), yet repeated test on product P6 (compare Table 5.1. with Table 5.2) do not indicate a sufficient precision of the method.

6.1. Future research

While this thesis showed that with a proper surface resistance correction the double cup method can be applied to certain materials under certain conditions in quality control situations, there is a number of outstanding issues. First, to determine surface resistance corrections one needs to repeat the same experiments with a temperature stability required by the modern European standards i.e., 0.2 °C.

Second, there is a popular belief that the uncertainty at 100 % RH is much higher than that at 75%. If a high precision temperature control is available one should continue this work to examine if this is the case.

Third, in the continuation of the work one should also examine thicker and thinner homogenous materials to see if the surface resistance correction is dependent on the rate of moisture flow or is entirely material related.

Fourth the MIC test method should be conducted parallel to DC testing in order to determine the relation between the two, should the MIC test method prove to be effective it would be of great value to research since it is a much easier test apparatus to create.

Having resolved these questions one could move to performing transient measurements of WVT e.g. such when desiccant that is not changed and total weight increase is recorded by an automatic balance.

References

1. ASHRAE, "AHSRAE 1993 Fundamentals". 1993.
2. ASTM D 779-94, "Standard test method for water resistance of paper, paperboard, and other sheet materials by the dry indicator method". Reapproved 1998.
3. ASTM C 755-97, "Standard practice for selection of vapor retarders for thermal insulation". 1997.
4. ASTM E96-00, "Standard test methods for water vapor transmission of materials". 2000.
5. ASTM E96-03, "Standard test methods for water vapor transmission of materials", Current version under development during 2003.
6. ASTM E 1169-87, "Standard guide for conducting ruggedness tests". 1987.
7. Babbitt J.D., "The diffusion of water through various building materials". Canadian journal of research, 17,15. 1939.
8. Babbitt J.D., "The permeability of building papers to water vapour". National research council of Canada (NRCC-900), 1940.
9. Babbitt J.D., "The movement of moisture through solids". ASTM Bulletin, February 1956.
10. Burch M.D., Thomas W.C., and Fanney A.H., "Water vapor permeability measurements of common building materials". ASHRAE transactions, 1992, Vol. 98.
11. Batdorf V., "Effect of relative humidity on permeance of coating". Journal of testing and evaluation (JTEVA), Vol. 17, No. 5, September 1989, pp. 299-306.
12. Bomberg M., "Testing water vapor transmission: Unresolved issues". Insitute for research in construction (IRC), National research council of Canada (NRCC – 30891), 1989.
13. Bomberg M, and Onysko D, "Heat air and moisture control in walls of Canadian houses: A review of the historic basis for current practices". Journal of thermal env. & bldg. sci., Vol. 00, No. 0, January 2002. pp. 1-25.
14. Chang S.C., and Hutcheon N.B., "Dependence of water vapor permability on temperature and humidity". ASHRAE Transactions, 62, 1956.

15. Douglas J.S., Kuehn T.H., Ramsey J.W. “A new moisture permeability measurement method and representative test data”. ASHRAE Transactions 1992, Vol. 98, Part – 2.
16. Ferro V. and Sacchi A, “On the water vapor transmission through porous materials”. International institute of refrigeration, 1969.
17. German standard, “Testing of thermal insulation, determination of water vapour permeability of building and insulating materials”. DIN 52615, June 1973.
18. Greebler, P. “Error in Vapor Permeance Measurements due to Diffusion in Lip Section”. unpublished memorandum, Johns-Manville Research Center, 1952.
19. Hansen K.K. and Lund H.B., “Cup method for determination of water vapour transmission properties of building materials. Sources of uncertainty in the methods”. Proceedings of the 2nd symposium, building physics in the Nordic countries, Trondheim, 1990, pp. 291-298.
20. Hinchley, J.W., Himus, G.W., “Evaporation in currents of air”, Transactions – Institute of Chemical Engineering, 2, 1924. pp.57-62.
21. International organization for standardization (ISO), “ISO Recommendation R 1195 – Determination of the water vapour transmission rate of plastics films and thin sheets”. June 1970.
22. International organization for standardization (ISO), “Revision to ISO 1663 Cellular plastics rigid – determination of water vapour transmission properties”. September 1989.
23. Joy F.A. and Wilson A.G., “Standardisation of the dish method for measuring water vapor transmission”. National research council of Canada, 31. 1965.
24. Kumaran M.K., “An alternative procedure for the analysis of data from the cup method measurements for determination of water vapor transmission properties”. National research council of Canada, Institute for research in construction (IRC), 1998.
25. McLean R.C. and Galbraith G.H., “Realistic vapour permeability values”. The journal of CIB, building research and practice, number 14,2, March/April, 1986.
26. McLean R.C., Galbraith G.H., and Sanders C.H., “Testing building materials moisture transmission testing of building materials and the presentation of vapour permeability values”. The journal of CIB, building research and practice, number 2, 1990.
27. Pazera M., “Evaluation of laboratory performance of weather resistive barriers”. Concordia University Thesis, 2003.

28. Pedersen C.R. "Ph.D. thesis, Thermal insulation laboratory". University of Denmark, 1990.
29. Schirmer, R. "ZVDI Beiheft Verfahrenstechnik". Nr. 6. S. 170, 1938.
30. Schwartz N.V. "Water vapor transmission and moisture accumulation in cellular plastics". Institute for research in construction (ISC), National research council of Canada (NRCC – 29771), 1988.
31. Schwartz N.V., Bomberg M., and Kumaran M.K., "Water vapor transmission and moisture accumulation in polyurethane and polyisocyanurate foams". ASTM reprint from standard technical publication 1039, 1989.
32. Teesdale, L.V., "Comparitive resistance to vapour transmission of various building materials". ASHVE Transactions, 49, 1943.
33. Thorsen T., "Inverted – Cup method". Proceedings of the symposium, building physics in the Nordic countries, Sweden, 1987, pp. 380-385.
34. Toas, M., "Results of the 1985 round robin test series using ASTM E 96-80" – "Water vapour transmission through building materials and systems, Mechanisms and measurement", ASTM-STP 1039. 1989. pp.73-90.

Appendix 1.1: Double cup test data

Material P6
Double cup test method (DC)
Liquid cup: Water, 100% relative humidity
Temperature control: $\pm 2.0^{\circ}\text{C}$

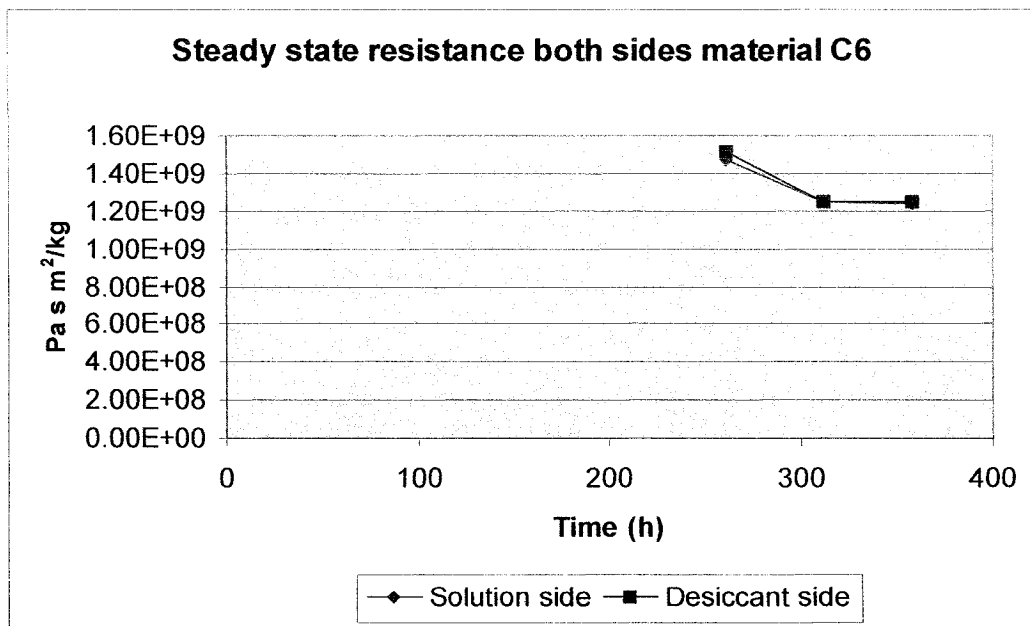
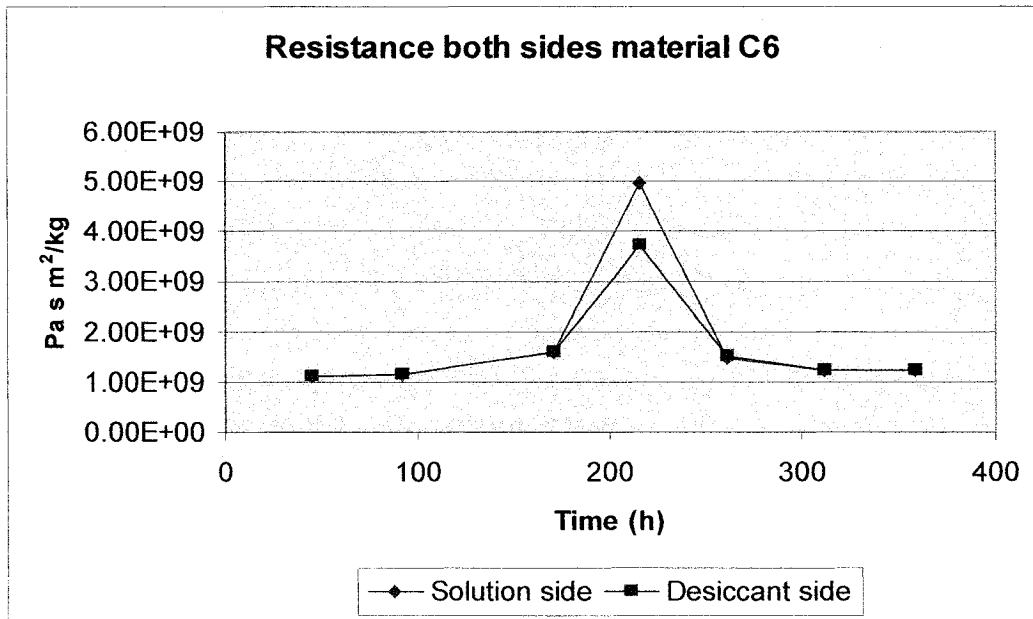

Material P6
 Double cup test method (DC)
 Liquid cup: Water, 100% R.H.
 August 23rd 2002 - Beginning of test
 Temperature control: ± 2.0 °C

Area of specimen: 0.01327 sq.m.

Thickness of material P6 in mm

Sample	Layer	Point 1	Point 2	Point 3	Point 4	Average thickness
6-A	1	0.14	0.14	0.15	0.16	0.148

Weight of paper in grammes
 6-A 1.09

Table 1: Recordings of weights for 6-A

Sr. No.	Date	Time		Hours	Mass			Temp. °C	Relative Humidity %	Pressure difference Δ P
		Time	Time		Wt. Of liquid Cup	New wt. Of Dry Cup	Wt. Of Ring + Specimen			
1	27/08/2002	16:40		0:00	1040.534	n/a	921.317	86.199	45	2950
2	29/08/2002	13:40		45:00	1034.924	920.865	926.903	86.184	46	2915
3	31/08/2002	14:25		46:75	1029.338	919.505	926.425	86.187	43	2880
4	03/09/2002	19:15		79:50	1022.377	926.000	926.383	86.181	45	2915
5	05/09/2002	16:15		44:00	1021.149	921.603	927.634	86.197	40	2898
6	07/09/2002	14:45		46:50	1016.743	920.100	925.868	86.194	46	2915
7	09/09/2002	16:45		50:00	1011.247	920.586	925.591	86.198	44	2880
8	11/09/2002	15:15		46:50	1005.993	924.702	925.817	86.203	46	2933

Table 2: Water Vapour Transmission through material in 6-A

Sr. No.	Weight change in cups			Time		Weight change per unit time		q/A		Permeance		Resistance			
	Water Cup	Dry Cup	Specimen Cup	Days	Hours	Seconds	dW/dt	dDes/dt	dSp/dt	Solution Side	Desiccant Side	Solution Side	Desiccant Side		
1	0.000	0.000	0.000	0	0:00	0	-0.0000346	0.0000345	-0.0000001	-0.0000026	0.0000026	8.951E-10	8.973E-10	1.12E+09	1.12E+09
2	-5.610	5.586	-0.015	2	45:00	162000	-0.0000332	0.0000330	0.0000000	-0.0000025	0.0000025	8.684E-10	8.643E-10	1.15E+09	1.16E+09
3	-5.586	5.560	0.003	2	45:75	168300	-0.0000243	0.0000240	0.0000000	-0.0000018	0.0000018	6.287E-10	6.212E-10	1.59E+09	1.61E+09
4	-6.961	6.878	-0.006	2	79:50	286200	-0.0000078	0.0000103	0.0000001	-0.0000006	0.0000008	2.016E-10	2.683E-10	4.96E+09	3.73E+09
5	-1.228	1.634	0.016	2	44:00	158400	-0.0000263	0.0000255	0.0000000	-0.0000020	0.0000019	6.803E-10	6.566E-10	1.47E+09	1.52E+09
6	-4.406	4.265	-0.003	2	46:50	167400	-0.0000305	0.0000305	0.0000000	-0.0000023	0.0000023	7.989E-10	7.981E-10	1.25E+09	1.25E+09
7	-5.496	5.491	0.004	2	50:00	180000	-0.0000314	0.0000312	0.0000000	-0.0000024	0.0000024	8.065E-10	8.029E-10	1.24E+09	1.25E+09
8	-5.254	5.231	0.005	2	46:50	167400									
Total average										2.058E+09	1.827E+09				
Steady state average										1.32E+09	1.34E+09				

Material P6
Double cup test method (DC)
Liquid cup: Salt concentration of 75% relative humidity
Temperature control: $\pm 2.0^{\circ}\text{C}$

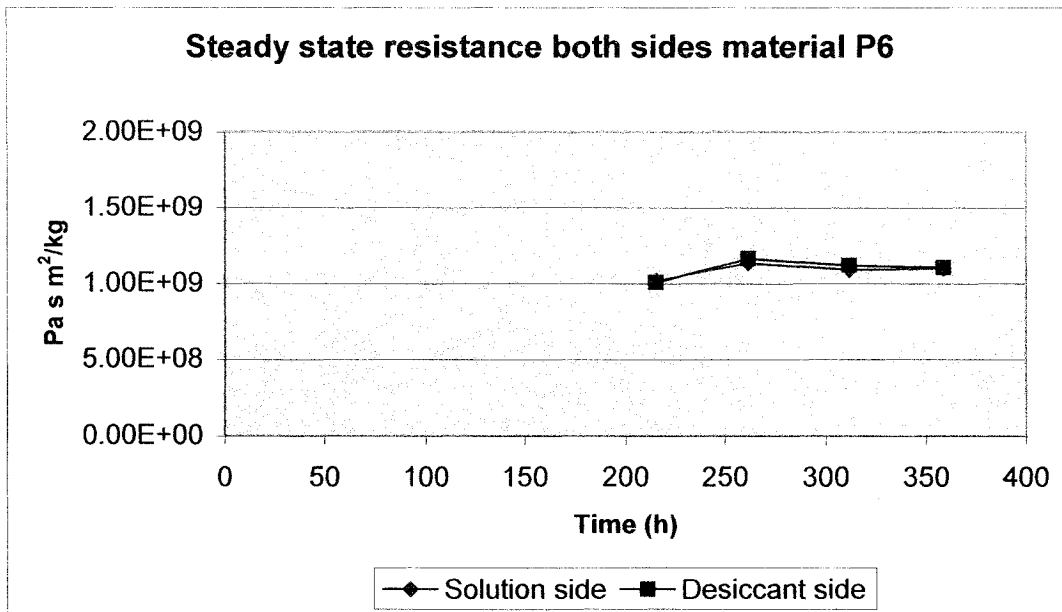
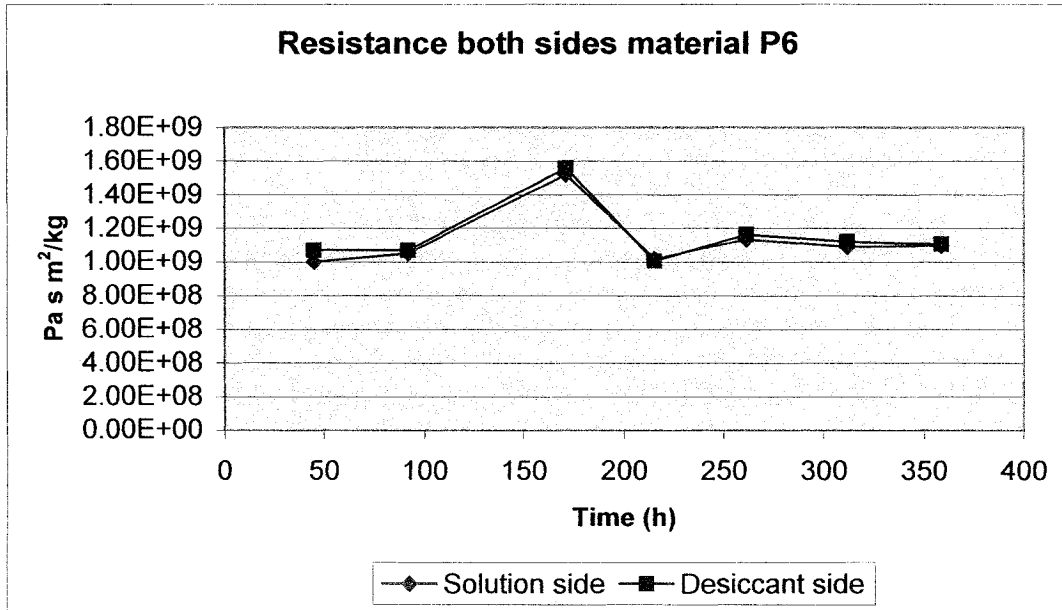

Material P6
 Double cup test method (DC)
 August 23rd 2002 - Beginning of test
 Liquid cup: Salt concentration of 75% Relative Humidity
 Temperature control: +- 2.0 °C

Area of specimen: 0.01327 sq.m.

Thickness of material 6 in mm

Sample Layer Point 1 Point 2 Point 3 Point 4 Average thickness
 6-A 1 0.17 0.15 0.12 0.15 0.1475

Weight of paper in grammes

6-A 1.07

Table 1.: Recordings of weights for 6-A

Sr. No.	Time		Hours	Wt. Of liquid Cup	Mass		Temp. °C	Relative Humidity %	Pressure difference ΔP	
	Date	Time			New wt. Of Dry Cup	Wt. Of Ring + Specimen Cup			Pa at 100%	Pa at 75%
1	27/08/2002	16:50	0.00	1142.560	n/a	956.397	23.8	45	2950	2212.70
2	29/08/2002	13:50	45.00	1137.866	946.306	962.784	23.6	46	2915	2186.49
3	31/08/2002	12:30	46.75	1133.290	944.720	950.808	23.4	43	2880	2180.29
4	03/09/2002	19:00	79.50	1127.824	952.751	950.051	25.9	45	2915	2186.49
5	05/09/2002	16:00	44.00	1123.349	946.255	957.284	23.6	40	2898	2173.39
6	07/09/2002	14:30	46.50	1119.074	945.292	950.424	23.6	46	2915	2186.49
7	09/09/2002	16:30	50.00	1114.318	954.525	949.920	22.6	44	2898	2173.39
8	11/09/2002	15:30	47.00	1109.828	N/A	958.986	23.7	46	2933	2195.59

Table 2.: Water Vapour Transmission through material in 6-A

Sr. No.	Weight change in cups		Specimen Cup	Time		Weight change per unit time		q/A		Permeance		Resistance			
	Water Cup	Dry Cup		Days	Hours	Seconds	dW/dt	dDes/dt	Solution Side	Desiccant Side	Solution Side	Desiccant Side	Solution Side	Desiccant Side	
1	0.000	0.000	0.000	0.00	0	0	-0.0000290	0.0000271	-0.0000001	0.0000020	9.9864E-10	9.333E-10	1.001E+09	1.071E+09	
2	-4.694	4.387	-0.022	45.00	162000	162000	-0.0000272	0.0000267	0.0000003	0.0000020	9.4846E-10	9.331E-10	1.054E+09	1.072E+09	
3	-4.576	4.502	0.046	46.75	168300	168300	-0.0000191	0.0000186	-0.0000014	0.0000014	6.5824E-10	6.42E-10	1.519E+09	1.558E+09	
4	-5.466	5.331	-0.059	79.50	286200	286200	-0.0000283	0.0000286	0.0000001	0.0000022	9.7956E-10	9.923E-10	1.021E+09	1.008E+09	
5	-4.475	4.533	0.023	44.00	158400	158400	-0.0000255	0.0000249	0.0000000	0.0000019	8.8016E-10	8.583E-10	1.366E+09	1.656E+09	
6	-4.275	4.169	-0.004	46.50	167400	167400	-0.0000264	0.0000257	0.0000000	0.0000020	9.1614E-10	8.915E-10	1.092E+09	1.122E+09	
7	-4.756	4.628	0.002	50.00	180000	180000	-0.0000265	0.0000264	0.0000000	0.0000020	9.0914E-10	9.033E-10	1.1E+09	1.107E+09	
8	-4.490	4.461	-0.001	47.00	169200	169200	-0.0000265	0.0000264	0.0000000	0.0000020	9.0914E-10	9.033E-10	1.1E+09	1.107E+09	
Total Average										1.132E+09	1.157E+09	Steady state average		1.087E+09	1.1E+09

Material P6
Double cup test method (DC)
Liquid cup: Magnesium nitrate hexahydrate, 52% relative humidity
Temperature control: $\pm 1.5^\circ\text{C}$

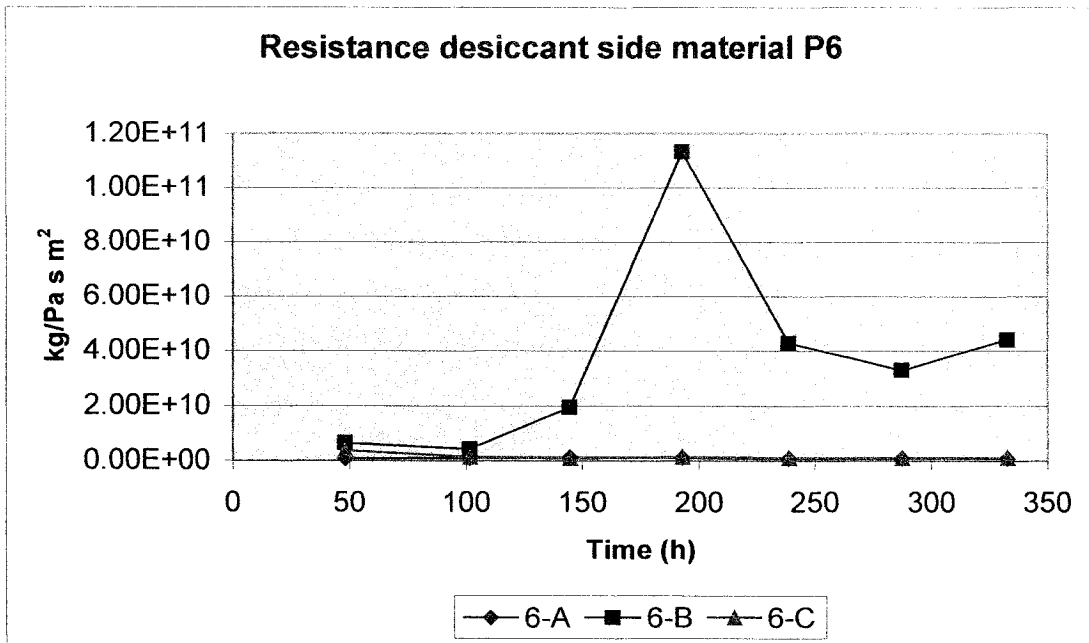
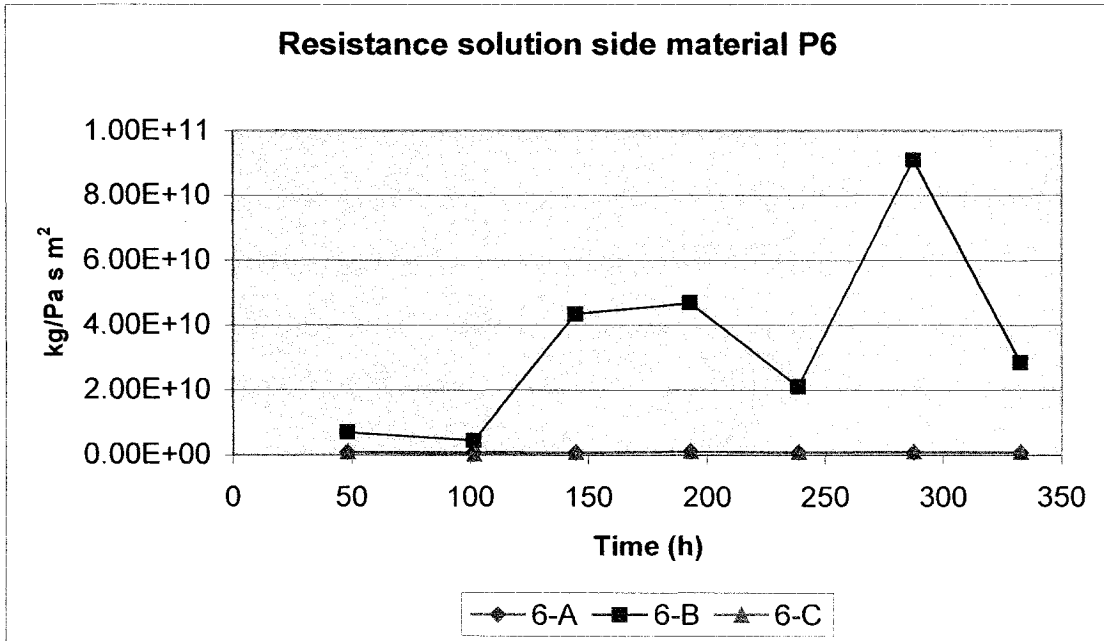

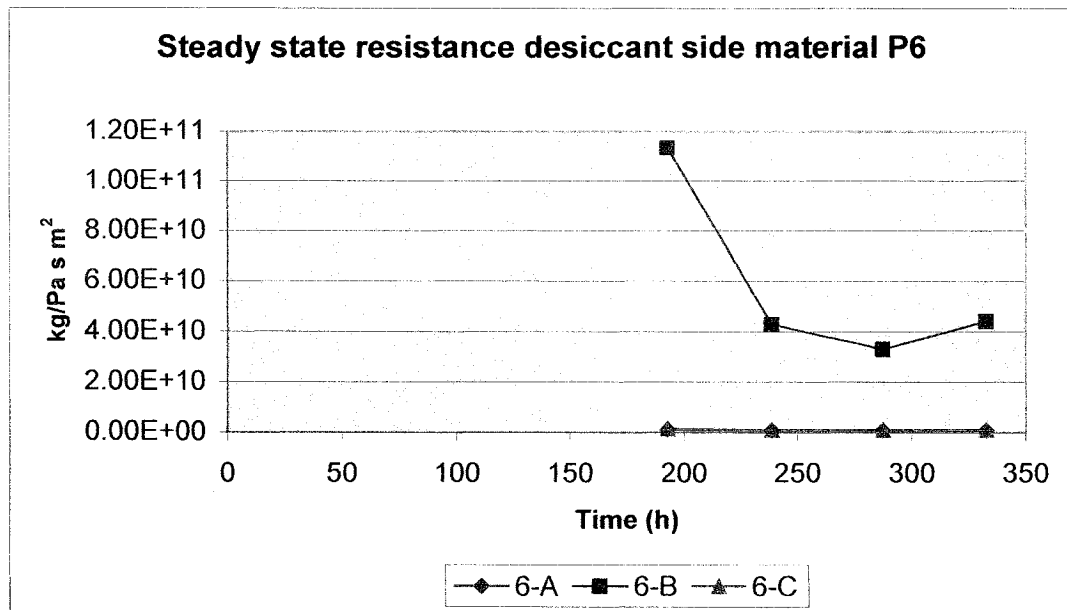
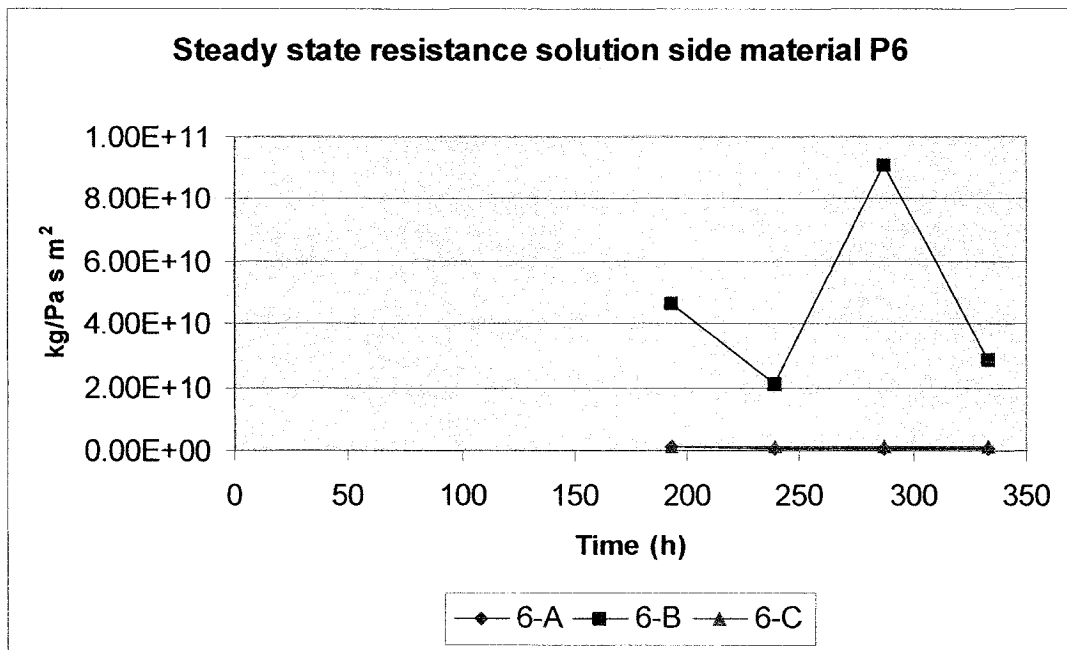

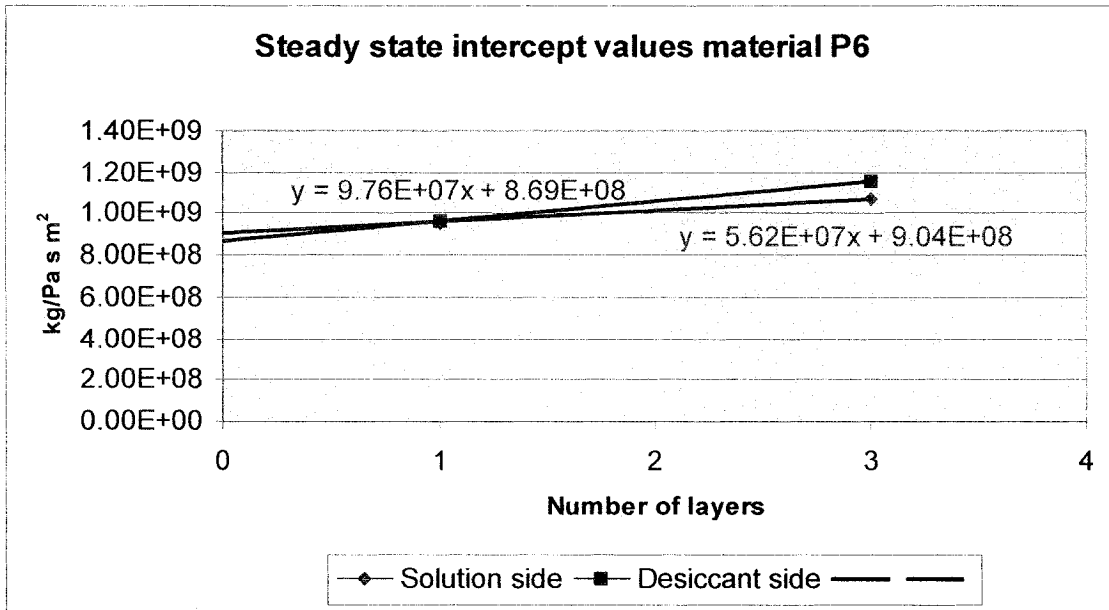
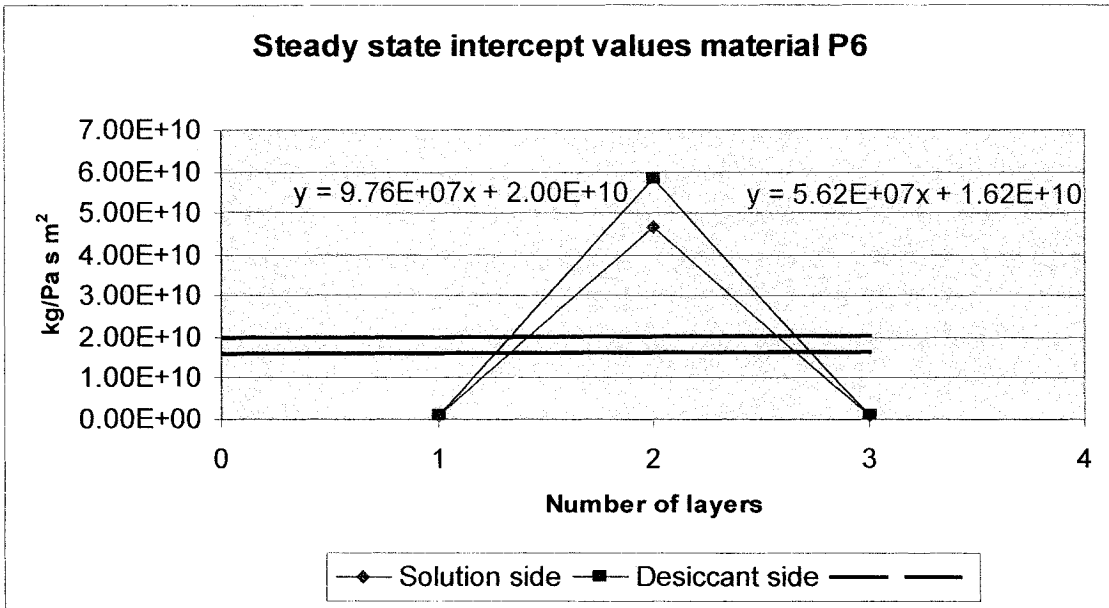

Material P6
 Double cup test method (DC)
 Liquid cup: Magnesium nitrate hexahydrate, 52% Relative Humidity
 August 7th 2002 - Beginning of test
 Temperature control: +- 1.5 °C

Area of specimen: 0.01327 sq.m.

Thickness of material P6 in mm

Sample Layer Point 1 Point 2 Point 3 Point 4 Average thickness
 6-A 1 0.15 0.15 0.14 0.16 0.15

Weight of paper in grammes

6-A 1.09

Table 1: Recordings of weights for 6-A

Sr. No.	Time		Hours	Mass			Temp. °C	Relative Humidity %	Pressure difference ΔP	
	Date	Time		Wt. Of liquid Cup	New wt. Of Dry Cup	Wt. Of Ring + Specimen			Pa at 100%	Pa at 52%
1	07/08/2002	14:15	0.00	N/A	958.200	84.860	23.1	44	2898	1507
2	09/08/2002	14:15	48.00	1013.330	959.460	84.800	23.4	47	2860	1498
3	11/08/2002	19:45	53.50	1009.310	958.630	84.790	23.8	49	2950	1534
4	13/08/2002	14:45	43.00	1005.000	953.355	84.785	24.7	56	3114	1619
5	15/08/2002	15:00	48.25	1001.620	956.690	84.775	25.8	55	3208	1668
6	17/08/2002	14:00	46.00	997.650	957.410	84.830	24.8	49	3132	1629
7	16/07/2002	14:30	48.50	993.665	959.715	84.805	24.2	44	3022	1571
8	19/07/2002	12:00	45.50	989.950	963.280	84.700	23.6	45	2915	1516

Table 2: Water Vapour Transmission through material in 6-A

Sr. No.	Weight change in cups			Time			Weight change per unit time			q/A		Permeance		Resistance			
	Water Cup	Dry Cup	Specimen Cup	Days	Hours	Seconds	dW/dt	dDes/dt	dSp/dt	Solution Side	Desiccant Side	Solution Side	Desiccant Side	Solution Side	Desiccant Side		
1	0.000	0.000	0.000	0	0.00	0	-0.0000226	0.0000240	-0.0000003	-0.0000017	0.0000018	1.1384E-09	1.2054E-09	8.78E+08	8.30E+08		
2	-3.910	4.140	-0.060	2	48.00	172800	-0.0000209	0.0000202	-0.0000001	-0.0000016	0.0000015	1.0253E-09	9.94658E-10	9.75E+08	1.01E+09		
3	-4.020	3.900	-0.100	2	53.50	192600	-0.0000278	0.0000163	0.0000000	-0.0000021	0.0000012	1.2957E-09	7.57577E-10	7.72E+08	1.32E+09		
4	-4.310	2.520	-0.005	2	43.00	154800	-0.0000195	0.0000192	-0.0000001	-0.0000015	0.0000014	8.7901E-10	8.67309E-10	1.14E+09	1.19E+09		
5	-3.380	3.335	-0.010	2	48.25	173700	-0.0000240	0.0000248	0.0000003	-0.0000018	0.0000019	1.1091E-09	1.1482E-09	9.02E+08	6.7E+08		
6	-3.970	4.110	0.055	2	46.00	165600	-0.0000228	0.0000227	-0.0000001	-0.0000017	0.0000017	1.0945E-09	1.08763E-09	9.14E+08	9.19E+08		
7	-3.965	3.960	-0.025	2	48.50	174600	-0.0000227	0.0000227	-0.0000006	-0.0000017	0.0000016	1.1274E-09	1.0819E-09	6.67E+08	9.24E+08		
8	-3.715	3.565	-0.105	3	45.50	163800	-0.0000227	0.0000218	-0.0000006	-0.0000017	0.0000016	Total Average		9.24E+08	1.00E+09		
														Steady state average		9.60E+08	9.67E+08

Material P6
 Double cup test method (DC)
 Liquid cup: Magnesium nitrate hexahydrate, 52% Relative Humidity
 October 18th 2002 - Beginning of test
 Temperature control: $\pm 1.5^\circ\text{C}$

Area of specimen: 0.01327 sq.m.

Thickness of material P6 in mm

Sample	Layer	Point 1	Point 2	Point 3	Point 4	Average thickness
6-B	1	0.11	0.14	0.15	0.15	0.1375
	2	0.12	0.11	0.12	0.14	0.1225
Total avg thickness						0.13

Weight of paper in grammes
 6-B
 2.207

Table 1.: Recordings of weights for 6-B

Sr. No.	Time		Hours	Mass			Temp. $^\circ\text{C}$	Relative Humidity %	Pressure difference ΔP	
	Date	Time		Wt. Of liquid Cup	New wt. Of Dry Cup	Wt. Of Ring + Specimen			Pa at 100%	Pa at 52%
1	18/10/2002	15:50	0.00	1007.900	n/a	957.838	25	20	3169	1648
2	20/10/2002	18:30	50.87	1007.296	958.260	958.493	26	23	3363	1749
3	22/10/2002	16:55	46.42	1006.442	957.434	959.142	26	22	3363	1749
4	24/10/2002	16:55	48.00	1006.355	960.970	957.628	25	21	3169	1648
5	26/10/2002	16:25	47.50	1006.275	957.745	961.003	25	29	3169	1648
6	28/10/2002	16:25	49.00	1006.092	957.661	957.835	25	23	3169	1648
7	30/10/2002	16:55	48.50	1006.050	957.756	957.777	25	18	3169	1648
8	01/11/2002	17:25	48.50	1005.917	0.000	957.842	24	22	3151	1638

Daylight savings time, one hour added.

Table 2.: Water Vapour Transmission through material in 6-B

Sr. No.	Weight change in cups		Time		Weight change per unit time		q/A		Permeance		Resistance				
	Water Cup	Dry Cup	Specimen Cup	Days	Hours	Seconds	dW/dt	dDes/dt	(g/s)	Solution Side	Desiccant Side	Solution Side	Desiccant Side		
1	0.000	0.000	0.000	0	0.00	0	-0.0000033	0.0000036	0.0000000	0.0000000	0.0000003	1.4268E-10	1.5473E-10	7.009E+09	6.463E+09
2	-0.604	0.655	0.003	2	50.67	182400	-0.0000051	0.0000053	0.0000000	0.0000004	0.0000000	2.2021E-10	2.2743E-10	4.541E+09	4.397E+09
3	-0.854	0.852	-0.004	2	46.42	167100	-0.0000005	0.0000011	0.0000000	0.0000000	0.0000000	2.3022E-11	5.1336E-11	4.344E+10	1.948E+10
4	-0.087	0.194	0.003	3	48.00	172800	-0.0000005	0.0000002	0.0000000	0.0000000	0.0000000	2.1392E-11	8.8243E-12	4.675E+10	3.33E+10
5	-0.080	0.033	0.036	2	47.50	171000	-0.0000005	0.0000005	0.0000000	0.0000001	0.0000000	4.7437E-11	2.333E-11	2.108E+10	4.288E+10
6	-0.183	0.090	-0.022	3	49.00	176400	-0.0000010	0.0000007	0.0000002	0.0000000	0.0000000	1.0999E-11	3.0379E-11	9.091E+10	3.292E+10
7	-0.042	0.116	0.027	2	48.50	174600	-0.0000002	0.0000005	0.0000001	0.0000000	0.0000000	3.5035E-11	2.2654E-11	2.654E+10	4.14E+10
8	-0.133	0.086	0.023	2	48.50	174600	-0.0000008	0.0000005	0.0000001	0.0000000	0.0000000	Total Average	3.461E+10	3.766E+10	
											Steady state average	4.682E+10	5.831E+10		

Material P6

Double cup test method (DC)
 Liquid cup: Magnesium nitrate hexahydrate, 52% Relative Humidity
 August 23rd 2002 - Beginning of test
 Temperature control: +- 1.5 °C

Area of specimen: 0.01327 sq.m.

Thickness of material P6 in mm

Sample Layer	Point 1	Point 2	Point 3	Point 4	Average thickness
6-C	1	0.15	0.14	0.12	0.1425
	2	0.13	0.17	0.15	0.155
	3	0.12	0.13	0.15	0.1375
					Total avg thickness 0.145

Weight of paper in grammes

6-C 22.57

Table 1: Recordings of weights for 6-C

Sr. No.	Time		Mass			Temp. °C	Relative Humidity %	Pressure difference Δ P	
	Date	Time	Hours	Wt. Of Liquid Cup	New wt. Of Dry Cup			Wt. Of Dry Cup	Wt. Of Ring + Specimen
1	29/08/2002	13:25	45.00	1183.738	n/a	959.402	90.863	2915	1516
2	31/08/2002	12:10	46.75	1180.461	958.321	960.280	90.994	2880	1498
3	03/09/2002	19:40	79.50	1163.452	995.272	962.554	90.878	2915	1516
4	05/09/2002	15:40	44.00	1159.773	957.661	998.662	90.946	2898	1507
5	07/09/2002	14:10	46.50	1156.969	957.741	960.061	90.977	2915	1516
6	09/09/2002	16:10	50.00	1153.473	957.632	961.139	90.030	2880	1498
7	11/09/2002	15:10	47.00	1150.199	960.099	960.867	91.026	2933	1525
8	13/09/2002	13:40	46.00	1146.834	N/A	963.125	91.149	3003	1561

Table 2: Water Vapour Transmission through material in 6-C

Sr. No.	Weight change in cups			Time			Weight change per unit time			q/A		Permeance		Resistance	
	Water Cup	Dry Cup	Specimen Cup	Days	Hours	Seconds	dW/dt (g/s)	dDes/dt (g/s)	dSp/dt	Solution Side	Desiccant Side	Solution Side	Desiccant Side	Solution Side	Desiccant Side
1	0.000	0.000	0.000	0	0.00	0	-0.0000195	0.0000052	0.0000008	-0.0000015	0.0000004	9.7964E-10	2.6247E-10	1.021E+09	3.81E+09
2	-3.277	0.878	0.131	2	46.75	168300	-0.0000594	0.0000148	-0.0000004	-0.0000045	0.0000011	2.9543E-09	7.3522E-10	3.38E+08	1.36E+09
3	-17.009	4.233	-0.116	3	79.50	286200	-0.0002232	0.0000215	0.0000004	-0.0000018	0.0000016	1.1615E-09	1.0766E-09	8.61E+08	9.29E+08
4	-3.679	3.410	0.088	2	44.00	158400	-0.0000168	0.0000143	0.0000002	-0.0000013	0.0000011	8.3265E-10	7.1268E-10	2.01E+09	3.03E+09
5	-2.804	2.400	0.031	2	46.50	167400	-0.0000194	0.0000189	-0.0000053	-0.0000015	0.0000014	9.7718E-10	9.4979E-10	1.023E+09	1.053E+09
6	-3.496	3.398	-0.947	2	50.00	180000	-0.0000193	0.0000191	0.0000059	-0.0000015	0.0000014	9.5614E-10	9.4475E-10	1.048E+09	1.058E+09
7	-3.274	3.235	0.996	2	47.00	169200	-0.0000203	0.0000183	0.0000007	-0.0000015	0.0000014	9.8072E-10	8.8191E-10	1.02E+09	1.34E+09
8	-3.365	3.026	0.123	3	46.00	165600	-0.0000203	0.0000183	0.0000007	-0.0000015	0.0000014	9.8072E-10	8.8191E-10	1.02E+09	1.34E+09
										Total Average		9.30E+08		1.54E+09	
										Steady state average		1.072E+09		1.162E+09	

Material P8
Double cup test method (DC)
Liquid cup: Water, 100% relative humidity
Temperature control: $\pm 1.0^{\circ}\text{C}$

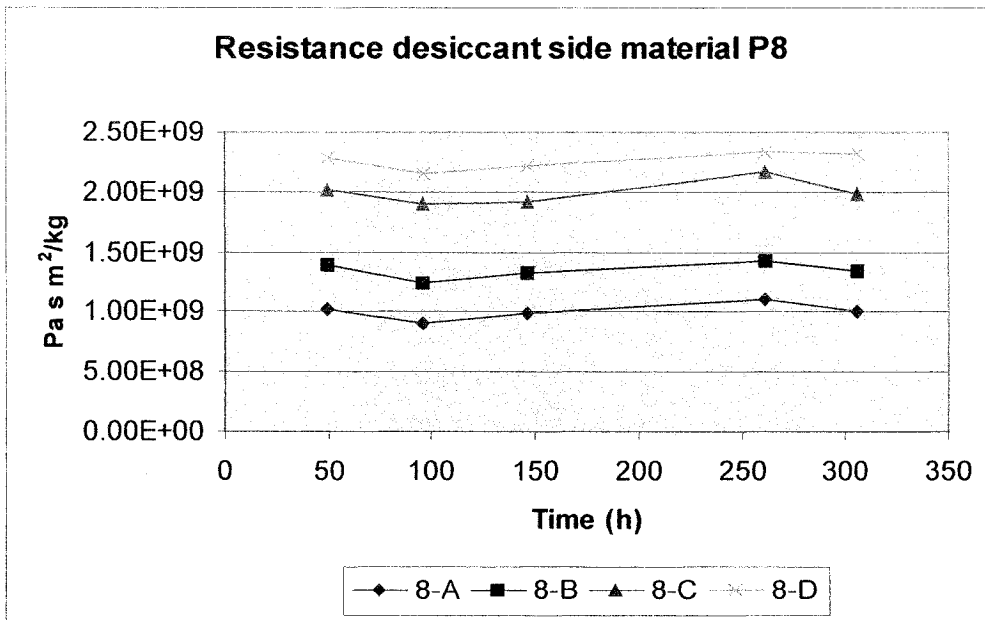
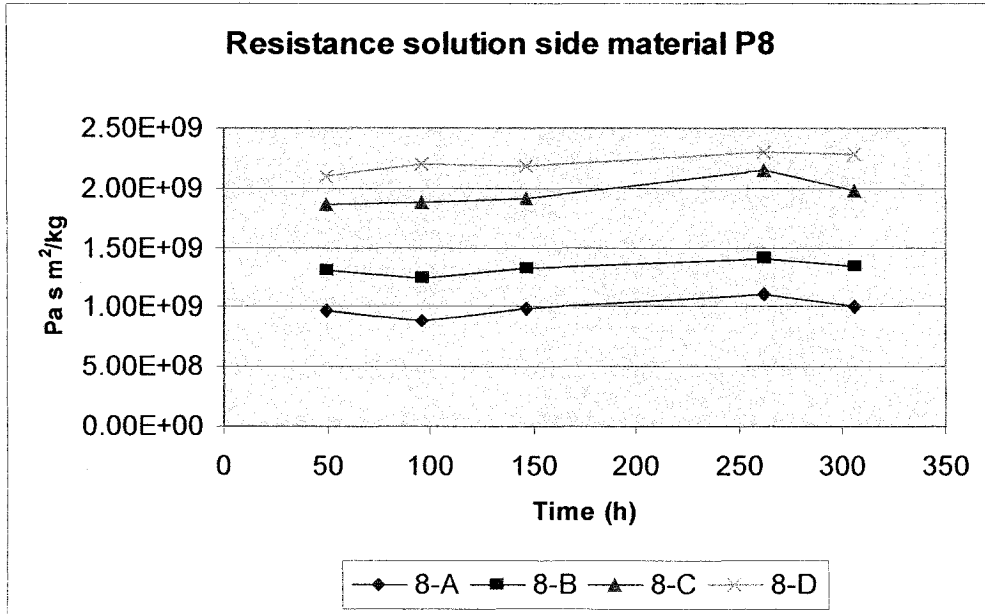

Steady state resistance solution side material P8

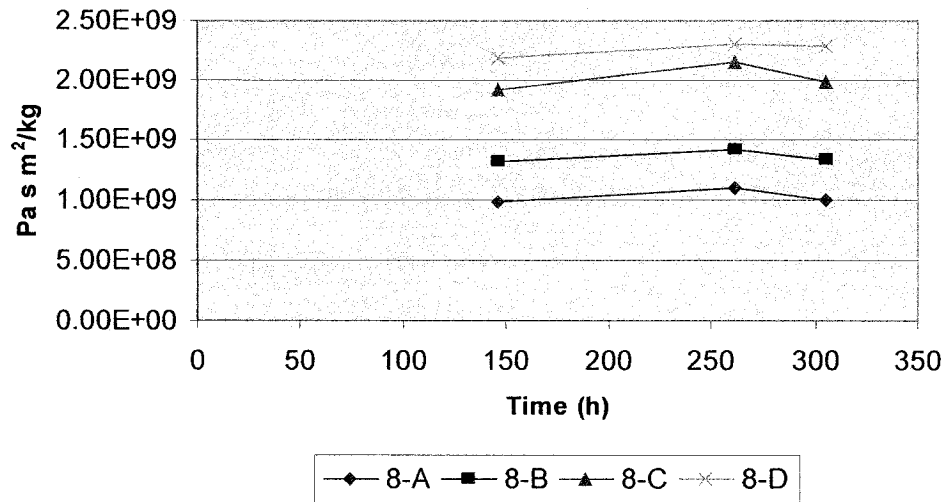

Steady state resistance desiccant side material P8

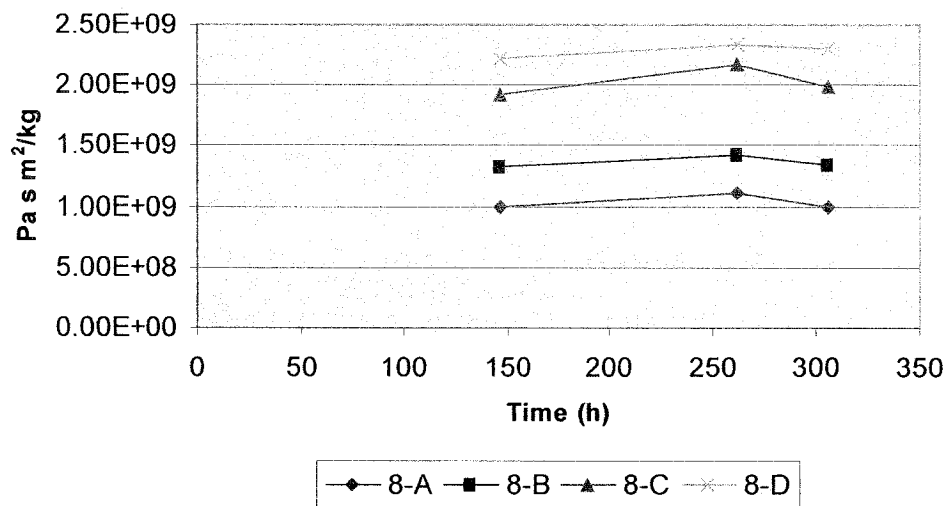

Steady state intercept values material P8

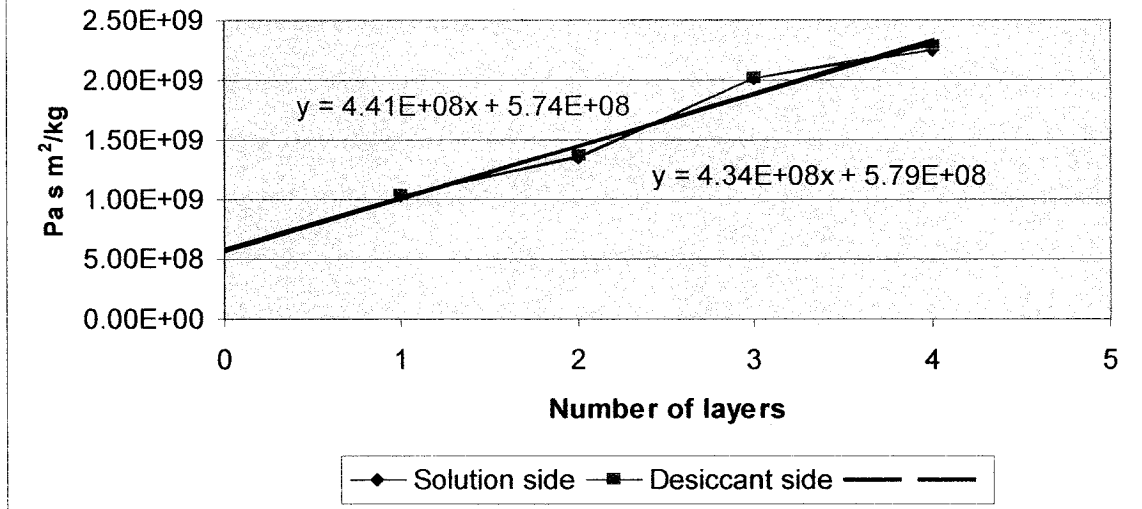

Material P8
 Double cup test method (DC)
 Liquid cup: Water, 100% R.H.
 December 6th 2001 - Beginning of test
 Temperature control: +/- 1.0 °C

Area of specimen: 0.01327 sq.m.

Thickness of material P8 in mm
 Sample Layer Point 1 Point 2 Point 3 Point 4
 8-A 1 0.19 0.16 0.2 0.15

Average thickness
 0.175

Weight of paper in grammes
 8-A 1.61

Table 1: Recordings of weights for 8-A

Sr. No.	Date	Time		Mass			Temp. °C	Relative Humidity %	Pressure difference Δ P
		Time	Hours	Wt. Of liquid Cup	New wt. Of Dry Cup	Wt. Of Ring + Specimen			
1	06/12/2001	17:30	0.00	1133.132	N/A	943.777	26	48	3363
2	08/12/2001	19:15	49.75	1125.368	943.424	951.181	25	38	3169
3	10/12/2001	17:00	45.75	1117.610	943.666	951.095	25	42	3169
4	12/12/2001	19:30	50.50	1109.824	943.933	951.348	25	42	3169
5	17/12/2001	14:00	115.50	1093.978	943.453	959.715	25	41	3169
6	19/12/2001	9:35	43.58	1086.972	943.554	950.445	26	43	3363

Table 2: Water Vapour Transmission through material in 8-A

Sr. No.	Weight change in cups			Time			Weight change per unit time			q/A		Permeance		Resistance			
	Water Cup	Dry Cup	Specimen Cup	Days	Hours	Seconds	dW/dt	dDes/dt	dSP/dt	Solution Side	Desiccant Side	Solution Side	Desiccant Side	Solution Side	Desiccant Side		
1	0.000	0.000	0.000	0	0:00	0	-0.0000434	0.0000413	0.0000000	-0.0000033	0.0000031	1.0308E-09	9.83E-10	9.70E+08	1.02E+09		
2	-7.764	7.404	0.005	2	49:75	179100	-0.0000471	0.0000466	0.0000000	-0.0000035	0.0000035	1.12E-09	1.107E-09	8.93E+08	9.03E+08		
3	-7.786	7.671	0.006	2	45:75	164700	-0.0000428	0.0000423	-0.0000001	-0.0000032	0.0000032	1.0183E-09	1.005E-09	9.82E+08	9.95E+08		
4	-7.786	7.682	-0.017	2	50:50	181800	-0.0000381	0.0000380	0.0000001	-0.0000029	0.0000029	9.0615E-10	9.025E-10	1.10E+09	1.11E+09		
5	-15.846	15.782	0.031	2	115:50	415800	-0.0000447	0.0000446	0.0000001	-0.0000034	0.0000034	1.0005E-09	9.985E-10	1.00E+09	1.00E+09		
6	-7.006	6.992	0.015	2	43:58	156900	-0.0000447	0.0000446	0.0000001	-0.0000034	0.0000034	1.0005E-09	9.985E-10	1.00E+09	1.00E+09		
Total average										9.90E+08		1.005E+09		9.90E+08		1.005E+09	
Steady state average										1.028E+09		1.036E+09		1.028E+09		1.036E+09	

Material P8
 Double cup test method (DC)
 Liquid cup: Water, 100% R.H.
 December 6th 2001 - Beginning of test
 Temperature control: +- 1.0 °C

Area of specimen: 0.01327 sq.m.

Thickness of material P8 in mm

Sample Layer	Point 1	Point 2	Point 3	Point 4	Average thickness
1	0.15	0.15	0.18	0.17	0.1625
2	0.15	0.14	0.17	0.17	0.1575
Total avrg.					0.160

Weight of paper in grammes
 8-B 3.22

Table 1.: Recordings of weights for 8-B

Sr. No.	Time		Mass		Temp. °C	Relative Humidity %	Pressure difference Δ P		
	Date	Time	Wt. Of liquid Cup	New wt. Of Dry Cup				Wt. Of Ring + Specimen	
1	08/12/2001	17:40	0.00	1180.815	N/A	943.373	85.270	48	3363
2	08/12/2001	19:20	49.67	1175.102	942.861	948.785	85.276	38	3169
3	10/12/2001	17:10	45.83	1169.491	940.560	948.419	85.288	25	3189
4	12/12/2001	19:35	50.42	1163.707	943.196	946.312	85.285	25	3169
5	17/12/2001	14:05	115.50	1151.368	942.864	955.471	85.275	25	3169
6	19/12/2001	9:40	43.58	1146.120	943.306	948.102	85.277	26	3363

Table 2.: Water Vapour Transmission through material in 8-B

Sr. No.	Weight change in cups			Time			Weight change per unit time			q/A		Permeance		Resistance	
	Water Cup	Dry Cup	Specimen Cup	Days	Hours	Seconds	dW/dt	dDes/dt	dSp/dt	Solution Side	Desiccant Side	Solution Side	Desiccant side	Solution Side	Desiccant side
1	0.000	0.000	0.000	0	0.00	0	-0.0000320	0.0000303	0.0000000	-0.0000024	0.0000023	7.5974E-10	7.197E-10	1.32E+09	1.39E+09
2	-5.713	5.412	0.006	2	49.67	178800	-0.0000340	0.0000337	0.0000000	-0.0000026	0.0000025	8.0858E-10	8.009E-10	1.24E+09	1.25E+09
3	-5.611	5.558	-0.008	2	45.83	165000	-0.0000319	0.0000317	0.0000001	-0.0000024	0.0000024	7.5774E-10	7.535E-10	1.32E+09	1.33E+09
4	-5.784	5.752	0.017	2	50.42	181500	-0.0000297	0.0000295	0.0000000	-0.0000022	0.0000022	7.056E-10	7.019E-10	1.42E+09	1.42E+09
5	-12.339	12.275	-0.010	2	115.50	415800	-0.0000334	0.0000334	0.0000000	-0.0000025	0.0000025	7.4944E-10	7.48E-10	1.38E+09	1.34E+09
6	-5.248	5.238	0.002	2	43.58	156900	-0.0000334	0.0000334	0.0000000	-0.0000025	0.0000025	7.4944E-10	7.48E-10	1.38E+09	1.34E+09
										Total average		1.325E+09		1.35E+09	
										Steady state average		1.357E+09		1.36E+09	

Material P8
 Double cup test method (DC)
 Liquid cup: Water, 100% R.H.
 December 6th 2001 - Beginning of test
 Temperature control: +- 1.0 °C

Area of specimen: 0.01327 sq. m.

Thickness of material P8 in mm
 Sample Layer Point 1 Point 2 Point 3 Point 4 Average thickness
 8-C 1 0.14 0.19 0.14 0.19 0.165
 2 0.15 0.19 0.17 0.16 0.1675
 3 0.17 0.19 0.17 0.2 0.1825
 Total avrg 0.172

Weight of paper in grammes
 8-C 4.955

Table 1.: Recordings of weights for 8-C

Sr. No.	Time		Hours	Mass		Temp. °C	Relative Humidity %	Pressure difference Δ P
	Date	Time		Wt. Of liquid Cup	New wt. Of Dry Cup			
1	08/12/2001	17:50	0.00	1185.832	N/A	26	48	3363
2	08/12/2001	19:25	49.58	1181.800	944.003	25	38	3169
3	10/12/2001	17:20	46.92	1178.004	944.259	25	42	3169
4	12/12/2001	19:40	50.33	1174.015	943.811	25	42	3169
5	17/12/2001	14:10	115.50	1165.870	943.751	25	41	3169
6	19/12/2001	9:45	43.58	1162.331	943.688	26	43	3363

Table 2.: Water Vapour Transmission through material in 8-C

Sr. No.	Weight change in cups			Time		Weight change per unit time			a/A		Permeance		Resistance		
	Water Cup	Dry Cup	Specimen Cup	Days	Hours	Seconds	dW/dt	dDes/dt	dSp/dt	Solution Side	Desiccant Side	Solution Side	Desiccant Side		
1	0.000	0.000	0.000	0	0.00	0	-0.0000226	0.0000209	0.0000000	-0.0000017	0.0000016	5.3709E-10	4.965E-10	1.86E+09	2.01E+09
2	-4.032	3.727	0.004	2	49.58	178500	-0.0000225	0.0000222	-0.0000002	-0.0000017	0.0000017	5.3439E-10	5.272E-10	1.87E+09	1.90E+09
3	-3.796	3.745	-0.026	2	46.92	168900	-0.0000220	0.0000220	0.0000001	-0.0000017	0.0000017	5.2345E-10	5.228E-10	1.91E+09	1.91E+09
4	-3.989	3.984	0.022	2	50.33	181200	-0.0000196	0.0000194	0.0000000	-0.0000015	0.0000015	4.6577E-10	4.609E-10	2.15E+09	2.17E+09
5	-8.145	8.060	0.000	2	115.50	415800	-0.0000226	0.0000225	0.0000000	-0.0000017	0.0000017	5.0538E-10	5.035E-10	1.98E+09	1.99E+09
6	-3.539	3.526	-0.002	2	43.58	156900	-0.0000226	0.0000225	0.0000000	-0.0000017	0.0000017	5.0538E-10	5.035E-10	1.98E+09	1.99E+09
Total average											1.954E+09	2.00E+09			
Steady state average											2.012E+09	2.02E+09			

Material P8
 Double cup test method (DC)
 Liquid cup: Water, 100% R.H.
 December 6th 2001 - Beginning of test
 Temperature control: +/- 1.0 °C

Area of specimen: 0.01327 sq.m.

Thickness of material P8 in mm

Sample Layer	Point 1	Point 2	Point 3	Point 4	Average thickness
1	0.18	0.14	0.17	0.17	0.165
2	0.17	0.18	0.15	0.18	0.17
3	0.17	0.2	0.17	0.17	0.1775
4	0.16	0.19	0.17	0.15	0.1675
Total avrg.					0.170

Weight of paper in grammes

8-D 6.5

Table 1.: Recordings of weights for 8-D

Sr. No.	Time		Mass		Temp. °C	Relative Humidity %	Pressure difference Δ P	
	Date	Time	Hours	Wt. Of liquid Cup				New wt. Of Dry Cup
1	06/12/2001	17:55	0.00	1174.228	N/A	944.076	90.321	3363
2	08/12/2001	19:35	49.67	1170.632	943.017	947.360	90.319	3169
3	10/12/2001	18:05	47.50	1167.362	943.639	946.371	90.332	3169
4	12/12/2001	19:45	49.67	1163.911	943.278	947.026	90.310	3169
5	17/12/2001	14:15	115.50	1156.330	943.595	950.795	90.303	3169
6	19/12/2001	9:50	43.58	1153.265	943.482	946.630	90.303	3363

Table 2.: Water Vapour Transmission through material in 8-D

Sr. No.	Weight change in cups		Time		Weight change per unit time		q/A		Permeance		Resistance				
	Water Cup	Dry Cup	Specimen Cup	Days	Hours	Seconds	dW/dt (g/s)	dDes/dt	dSp/dt	Solution Side	Desiccant Side	Solution Side	Desiccant Side		
1	0.000	0.000	0.000	0	0.00	0	-0.0000201	0.0000184	0.0000000	-0.0000015	0.0000014	4.7821E-10	4.367E-10	2.09E+09	2.29E+09
2	-3.596	3.284	-0.002	2	49.67	17800	-0.0000191	0.0000196	0.0000001	-0.0000014	0.0000015	4.5469E-10	4.664E-10	2.20E+09	2.14E+09
3	-3.270	3.354	0.013	2	47.50	171000	-0.0000189	0.0000189	-0.0000001	-0.0000015	0.0000014	4.5893E-10	4.504E-10	2.18E+09	2.22E+09
4	-7.581	7.517	-0.007	2	115.50	415800	-0.0000182	0.0000181	0.0000000	-0.0000014	0.0000014	4.3352E-10	4.299E-10	2.31E+09	2.33E+09
5	-3.065	3.035	0.000	2	43.58	156900	-0.0000195	0.0000193	0.0000000	-0.0000015	0.0000015	4.3789E-10	4.334E-10	2.28E+09	2.31E+09
Total average										2.21E+09		2.26E+09		2.28E+09	
Steady state average										2.26E+09		2.28E+09		2.28E+09	

Material P8
Double cup test method (DC)
Liquid cup: Salt concentration of 75% relative humidity
Temperature control: $\pm 2.0^{\circ}\text{C}$

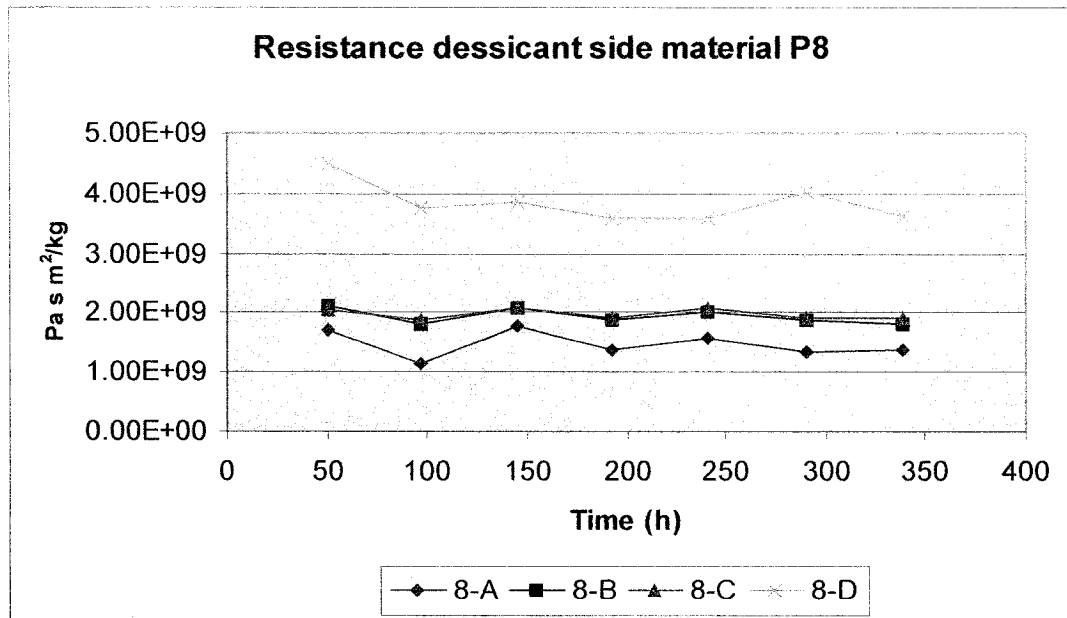
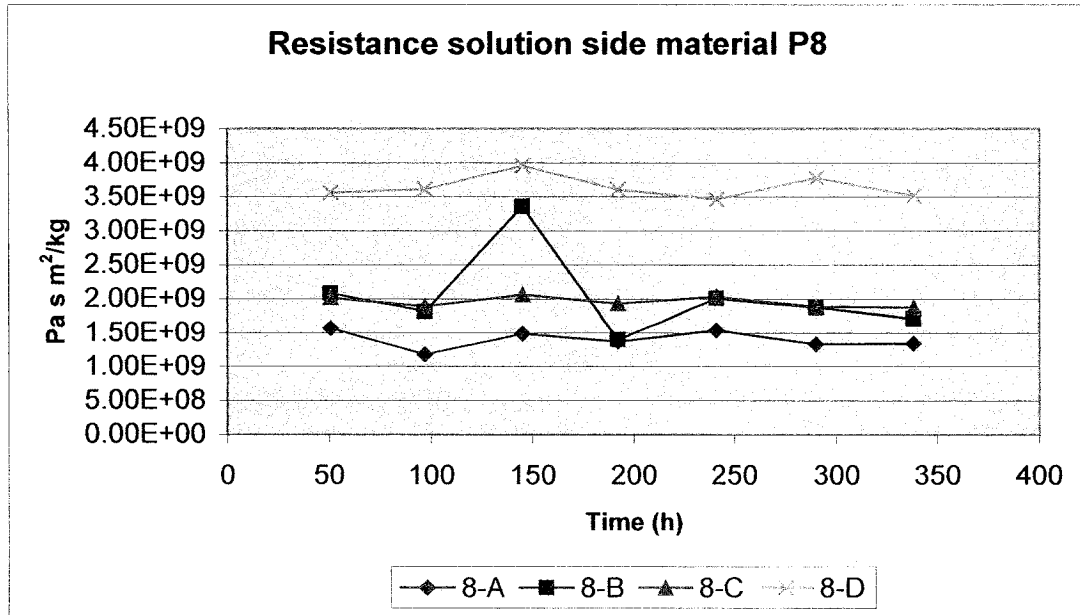

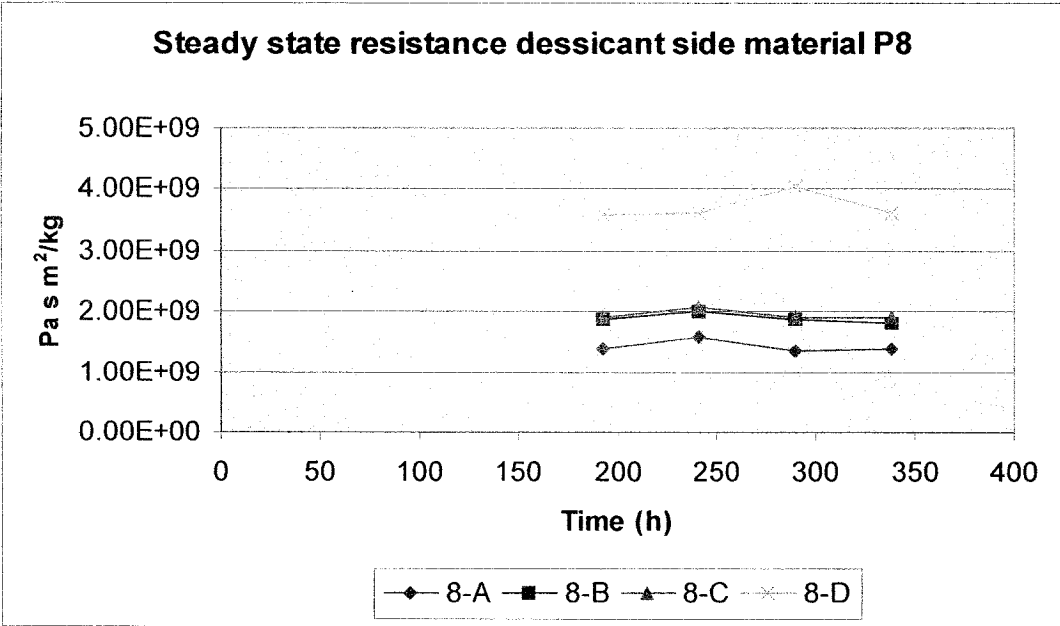
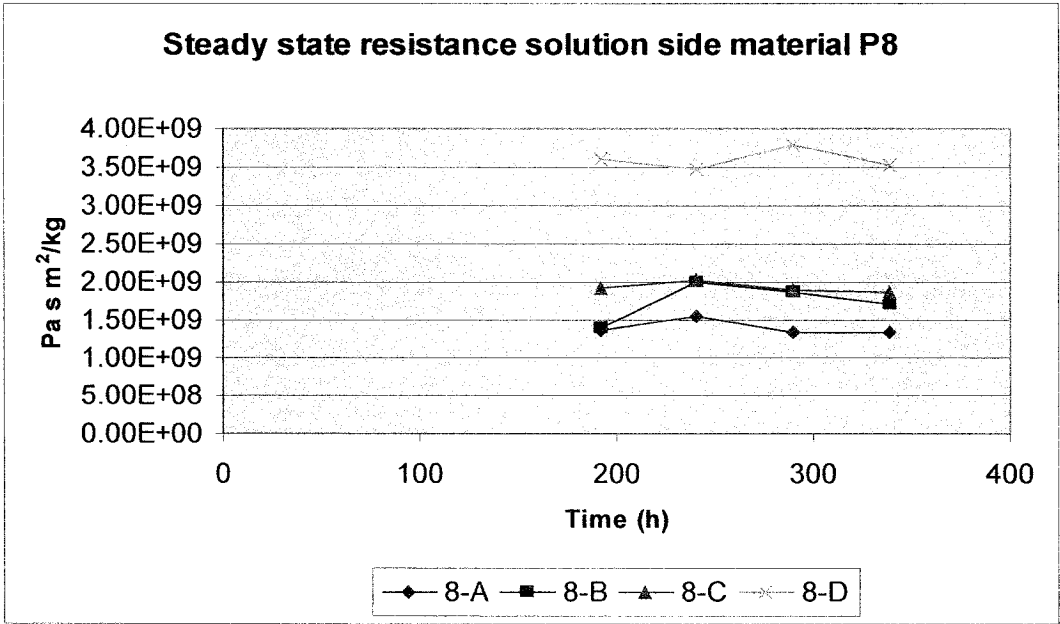

Steady state intercept values material P8

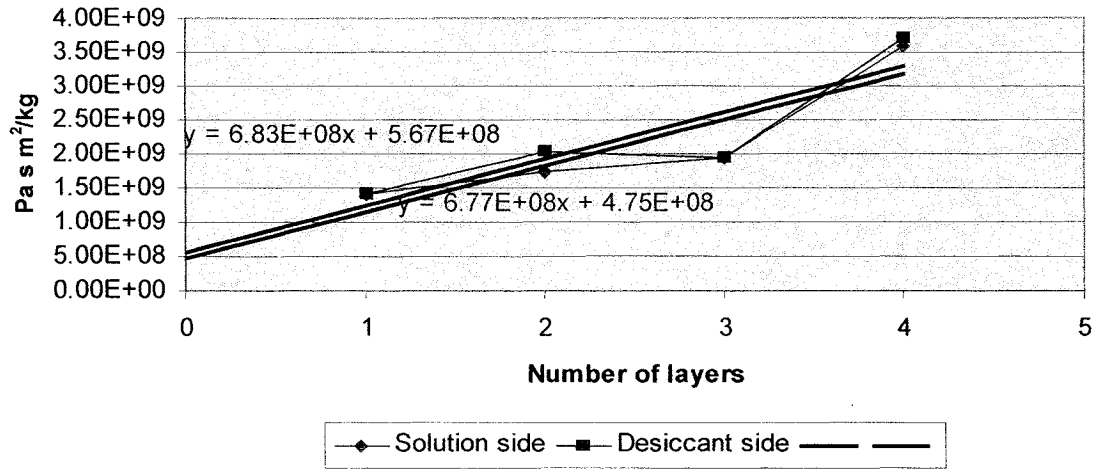

Material P8
 Double cup test method (DC)
 October 18th 2002 - Beginning of test
 Liquid cup: Salt concentration of 75% Relative Humidity
 Temperature control: +- 2.0 °C

Area of specimen: 0.01327 sq.m.

Thickness of material P8 in mm

Sample Layer	Point 1	Point 2	Point 3	Point 4	Average thickness
1	0.15	0.18	0.18	0.17	0.17
2	0.2	0.16	0.16	0.2	0.18
3	0.15	0.16	0.14	0.18	0.1575
4	0.2	0.19	0.19	0.21	0.1975
Total avg.					0.176

Weight of paper in grammes

8-D 6.643

Table 1.: Recordings of weights for 8-D

Sr. No.	Time		Hours	Mass		Temp. °C	Relative Humidity %	Pressure difference ΔP	
	Date	Time		Wt. Of liquid Cup	New wt. Of Dry Cup			Wt. Of Ring + Specimen	Pa at 100%
1	18/10/2002	16:15	0.00	1032.890	0.000	25	20	3196	2397.225
2	20/10/2002	18:55	50.67	1031.176	920.563	26	23	3363	2522.475
3	22/10/2002	17:20	46.42	1029.629	921.145	26	22	3363	2522.475
4	24/10/2002	17:20	48.00	1028.241	921.536	25	21	3196	2397.225
5	26/10/2002	16:20	47.00	1026.750	921.796	25	29	3196	2397.225
6	28/10/2002	16:20	49.00	1025.129	919.511	25	23	3196	2397.225
7	30/10/2002	17:20	49.00	1023.584	921.108	25	18	3325	2493.375
8	01/11/2002	17:35	48.25	1022.037	922.608	24	22	3151	2363.25

Daylight savings time, one hour added

Table 2.: Water Vapour Transmission through material in 8-D

Sr. No.	Weight change in cups			Time			Weight change per unit time			g/A		Permeance		Resistance	
	Water Cup	Dry Cup	Specimen Cup	Days	Hours	Seconds	dW/dt	dDes/dt	dSp/dt	Solution Side	Desiccant Side	Solution Side	Desiccant Side	Solution Side	Desiccant Side
1	0.000	0.000	0.000	0	0.00	0	-0.0000094	0.0000074	0.0000001	(kg/s m ²)	(kg/Pa s m ²)	2.8073E-10	2.2242E-10	3.56E+09	4.50E+09
2	-1.714	1.358	0.016	2	50.67	182400	-0.0000093	0.0000089	0.0000000	-0.0000007	0.0000007	2.7658E-10	2.6549E-10	3.62E+09	3.77E+09
3	-1.547	1.485	0.005	2	46.42	167100	-0.0000080	0.0000082	0.0000001	-0.0000006	0.0000006	2.525E-10	2.5887E-10	3.96E+09	3.86E+09
4	-1.388	1.423	0.009	2	48.00	172800	-0.0000088	0.0000089	0.0000000	-0.0000007	0.0000007	2.7701E-10	2.7906E-10	3.61E+09	3.58E+09
5	-1.491	1.502	-0.001	2	47.00	169200	-0.0000092	0.0000092	0.0000001	-0.0000007	0.0000007	2.8887E-10	2.7729E-10	3.46E+09	3.61E+09
6	-1.621	1.556	0.009	2	49.00	176400	-0.0000088	0.0000088	0.0000000	-0.0000006	0.0000006	2.8471E-10	2.4741E-10	3.78E+09	4.04E+09
7	-1.545	1.444	-0.008	2	49.00	176400	-0.0000089	0.0000089	0.0000001	-0.0000007	0.0000007	2.8399E-10	2.7537E-10	3.52E+09	3.63E+09
8	-1.547	1.500	0.017	2	48.25	173700	-0.0000089	0.0000086	0.0000001	-0.0000007	0.0000007	Total Average	3.844E+09	3.86E+09	
											Steady state average		3.693E+09	3.72E+09	

Material P8
 Double cup test method (DC)
 October 18th 2002 - Beginning of test
 Liquid cup: Salt concentration of 75% Relative Humidity
 Temperature control: +/- 2.0 °C

Area of specimen: 0.01327 sq.m.

Average Thickness

Thickness of material P8 in mm
 Sample Layer Point 1 Point 2 Point 3 Point 4
 8-C 1 0.15 0.16 0.16 0.16
 2 0.18 0.15 0.16 0.18
 3 0.16 0.16 0.13 0.16
 Total Avrg. 0.159

Weight of paper in grammes
 8-C 4.974

Table 1.: Recordings of weights for 8-C

Sr. No.	Date	Time	Time		Mass		Temp. °C	Relative Humidity %	Pressure difference ΔP	
			Hours	Wt. Of liquid Cup	New wt. Of Dry Cup	Wt. Of Dry Cup			Pa at 100%	Pa at 75%
1	18/10/2002	16:10	0:00	1015.675	N/A	922.451	25	20	3196	2397.225
2	20/10/2002	18:50	50:67	1012.651	922.840	925.436	26	23	3363	2522.475
3	22/10/2002	17:15	46:42	1009.693	922.026	925.803	26	22	3363	2522.475
4	24/10/2002	17:15	48:00	1007.030	923.007	924.672	25	21	3196	2397.225
5	26/10/2002	16:15	47:00	1004.243	919.486	925.813	25	23	3196	2397.225
6	28/10/2002	16:15	49:00	1001.484	921.736	922.189	25	23	3196	2397.225
7	30/10/2002	17:15	49:00	998.505	922.340	924.675	25	18	3196	2397.225
8	01/11/2002	17:30	48:25	995.594	0.000	925.209	24	22	3151	2363.25

Daylight savings time one hour added

Table 2.: Water Vapour Transmission through material in 8-C

Sr. No.	Weight change in cups		Time			Weight change per unit time		q/A		Permeance		Resistance		
	Water Cup	Dry Cup	Days	Hours	Seconds	dW/dt	dDes/dt	dSp/dt	Solution Side	Desiccant Side	Solution Side	Desiccant Side		
1	0.000	0.000	0	0:00	0	-0.0000166	0.0000164	0.0000001	-0.0000012	0.0000012	4.9529E-10	4.889E-10	2.02E+09	2.05E+09
2	-3.024	2.985	2	50:67	182400	-0.0000177	0.0000000	0.0000000	-0.0000013	0.0000013	5.2884E-10	5.2973E-10	1.89E+09	1.89E+09
3	-2.958	2.963	2	46:42	167100	-0.0000154	0.0000153	0.0000002	-0.0000012	0.0000012	4.8445E-10	4.8136E-10	2.06E+09	2.08E+09
4	-2.663	2.846	2	48:00	172800	-0.0000165	0.0000166	0.0000000	-0.0000012	0.0000012	5.1779E-10	5.2132E-10	1.93E+09	1.92E+09
5	-2.787	2.908	2	47:00	169200	-0.0000156	0.0000153	0.0000001	-0.0000012	0.0000012	4.9167E-10	4.8169E-10	2.03E+09	2.08E+09
6	-2.759	2.703	2	49:00	176400	-0.0000169	0.0000167	0.0000000	-0.0000013	0.0000013	5.3087E-10	5.2375E-10	1.88E+09	1.91E+09
7	-2.979	2.939	2	49:00	176400	-0.0000168	0.0000168	0.0000000	-0.0000013	0.0000013	5.3439E-10	5.2668E-10	1.87E+09	1.90E+09
8	-2.911	2.869	2	48:25	173700	-0.0000168	0.0000165	0.0000001	-0.0000013	0.0000013	Total Average	Total Average	1.93E+09	1.95E+09

Material P8
 Double cup test method (DC)
 October 18th 2002 - Beginning of test
 Liquid cup: Salt concentration of 75% Relative Humidity
 Temperature control: +- 2.0 °C

Area of specimen: 0.01327 sq.m.

Thickness of material P8 in mm

Sample	Layer	Point 1	Point 2	Point 3	Point 4	Average Thickness
8-B	1	0.17	0.16	0.13	0.15	0.1525
	2	0.16	0.16	0.15	0.17	0.16
						Total Avrg. 0.156

Weight of paper in grammes
 8-B 3.302

Table 1: Recordings of weights for 8-B

Sr. No.	Time		Hours	Mass		Temp. °C	Relative Humidity %	Pressure difference Δ P	
	Date	Time		Wt. Of liquid Cup	New wt. Of Dry Cup			Wt. Of Ring + Specimen	Pa at 100%
1	18/10/2002	18:05	0.00	1087.639	N/A	25	20	3196	2397.225
2	20/10/2002	18:45	50.67	1084.705	958.310	26	23	3363	2522.475
3	22/10/2002	17:10	46.42	1081.619	959.315	26	22	3363	2522.475
4	24/10/2002	17:10	48.00	1079.982	956.210	25	21	3196	2397.225
5	26/10/2002	16:10	47.00	1078.142	957.901	25	29	3196	2397.225
6	28/10/2002	16:10	49.00	1073.347	956.408	25	23	3196	2397.225
7	30/10/2002	17:10	49.00	1070.349	957.630	25	18	3196	2397.225
8	01/11/2002	17:25	48.25	1067.163	960.544	24	22	3151	2363.25

Daylight savings time: one hour added

Table 2: Water Vapour Transmission through material in 8-B

Sr. No.	Weight change in cups			Time		Weight change per unit time		q/A		Permeance		Resistance			
	Water Cup	Dry Cup	Specimen Cup	Days	Hours	Seconds	dW/dt	dDes/dt	dSp/dt	Solution Side	Desiccant Side	Solution Side	Desiccant Side		
1	0.000	0.000	0.000	0	0.00	0	-0.0000161	0.0000160	0.0000000	-0.0000012	0.0000012	4.805E-10	4.7678E-10	2.081E+09	2.097E+09
2	-2.934	2.911	0.004	2	50.67	182400	-0.0000185	0.0000185	0.0000000	-0.0000014	0.0000014	5.517E-10	5.5154E-10	1.813E+09	1.813E+09
3	-3.086	3.085	-0.004	2	46.42	167100	-0.0000095	0.0000153	0.0000000	-0.0000007	0.0000007	2.978E-10	4.799E-10	3.358E+09	2.084E+09
4	-1.637	2.638	0.005	2	48.00	172800	-0.0000227	0.0000169	0.0000000	-0.0000013	0.0000013	7.134E-10	5.3043E-10	1.402E+09	1.885E+09
5	-3.840	2.855	0.000	2	47.00	169200	-0.0000158	0.0000157	0.0000000	-0.0000013	0.0000013	4.981E-10	4.9506E-10	2.008E+09	2.02E+09
6	-2.795	2.778	0.006	2	49.00	176400	-0.0000170	0.0000169	0.0000000	-0.0000013	0.0000013	5.343E-10	5.3105E-10	1.872E+09	1.883E+09
7	-2.998	2.980	0.004	2	49.00	176400	-0.0000183	0.0000174	0.0000000	-0.0000014	0.0000014	5.849E-10	5.533E-10	1.71E+09	1.807E+09
8	-3.186	3.014	-0.006	2	48.25	173700									
										Total Average		2.035E+09		1.941E+09	
										Steady state average		1.748E+09		1.899E+09	

Material P8
 Double cup test method (DC)
 October 18th 2002 - Beginning of test
 Liquid cup: Salt concentration of 75% Relative Humidity
 Temperature control: +- 2.0 °C

Area of specimen: 0.01327 sq.m.

Thickness of material P8 in mm

Sample Layer Point 1 Point 2 Point 3 Point 4 Average thickness
 8-A 1 0.16 0.15 0.15 0.16 0.155

Weight of paper in grammes

8-A 1.607

Table 1.: Recordings of weights for 8-A

Sr. No.	Time		Mass				Temp. °C	Relative Humidity %	Pressure difference	
	Date	Time	Hours	Wt. Of liquid Cup	New wt. Of Dry Cup	Wt. Of Ring + Specimen			Pa at 100%	Δ P Pa at 75%
1	18/10/2002	16:00	0.00	1072.219	N/A	87.019	20	3196	2397.225	
2	20/10/2002	18:40	50.67	1068.325	943.254	87.035	23	3363	2522.475	
3	22/10/2002	17:05	48.42	1063.575	946.481	87.051	22	3363	2522.475	
4	24/10/2002	17:05	48.00	1059.880	943.246	87.041	21	3196	2397.225	
5	26/10/2002	16:05	47.00	1055.957	945.289	87.042	29	3196	2397.225	
6	28/10/2002	16:05	49.00	1052.312	944.591	87.042	25	3196	2397.225	
7	30/10/2002	17:05	49.00	1048.110	943.947	87.047	18	3196	2397.225	
8	01/11/2002	17:20	48.25	1044.055	0.000	87.057	22	3151	2363.25	

Daylight savings time, one hour added

Table 2.: Water Vapour Transmission through material in 8-A

Sr. No.	Weight change in cups			Time			Weight change per unit time			g/A		Permeance		Resistance	
	Water Cup	Dry Cup	Specimen Cup	Days	Hours	Seconds	dW/dt (g/s)	dDes/dt (g/s)	dSpr/dt	Solution Side	Desiccant Side	Solution Side	Desiccant Side	Solution Side	Desiccant Side
1	0.000	0.000	0.000	0	0.00	0	-0.0000213	0.0000195	0.0000001	-0.0000016	0.0000015	6.3778E-10	5.8308E-10	1.568E+09	1.715E+09
2	-3.894	3.560	0.016	2	50.67	182400	-0.0000284	0.0000295	0.0000001	-0.0000021	0.0000022	8.4922E-10	8.8051E-10	1.178E+09	1.136E+09
3	-4.750	4.925	0.016	2	46.42	167100	-0.0000214	0.0000179	-0.0000001	-0.0000016	0.0000013	6.7219E-10	5.6195E-10	1.488E+09	1.78E+09
4	-3.695	3.689	-0.010	2	48.00	172800	-0.0000232	0.0000232	0.0000000	-0.0000017	0.0000017	7.2885E-10	7.2811E-10	1.372E+09	1.373E+09
5	-3.923	3.919	0.001	2	47.00	169200	-0.0000207	0.0000203	0.0000000	-0.0000016	0.0000015	6.4956E-10	6.3922E-10	1.54E+09	1.564E+09
6	-3.645	3.587	0.000	2	49.00	176400	-0.0000238	0.0000237	0.0000000	-0.0000018	0.0000018	7.4862E-10	7.4581E-10	1.335E+09	1.341E+09
7	-4.202	4.184	0.005	2	49.00	176400	-0.0000233	0.0000227	0.0000001	-0.0000018	0.0000017	7.4441E-10	7.2385E-10	1.343E+09	1.382E+09
8	-4.055	3.943	0.010	2	48.25	173700	-0.0000233	0.0000227	0.0000001	-0.0000018	0.0000017	7.4441E-10	7.2385E-10	1.403E+09	1.47E+09
										Total Average		1.403E+09		1.47E+09	
										Steady state average		1.388E+09		1.415E+09	

Material P8
Double cup test method (DC)
Liquid cup: Salt concentration of 75% relative humidity
Temperature control: $\pm 1.5^{\circ}\text{C}$

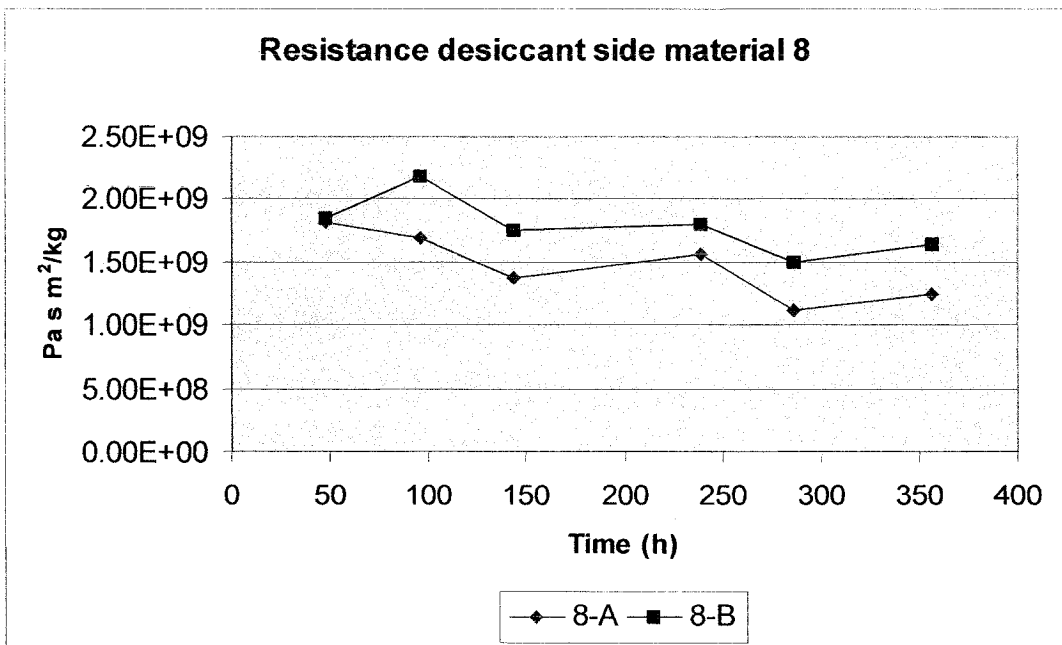
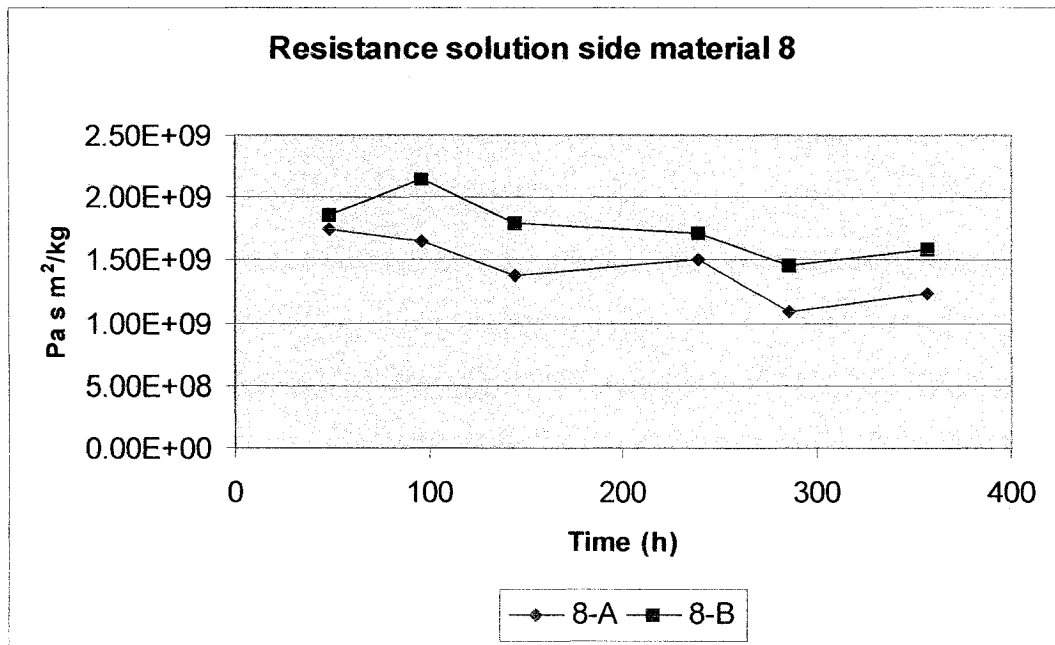

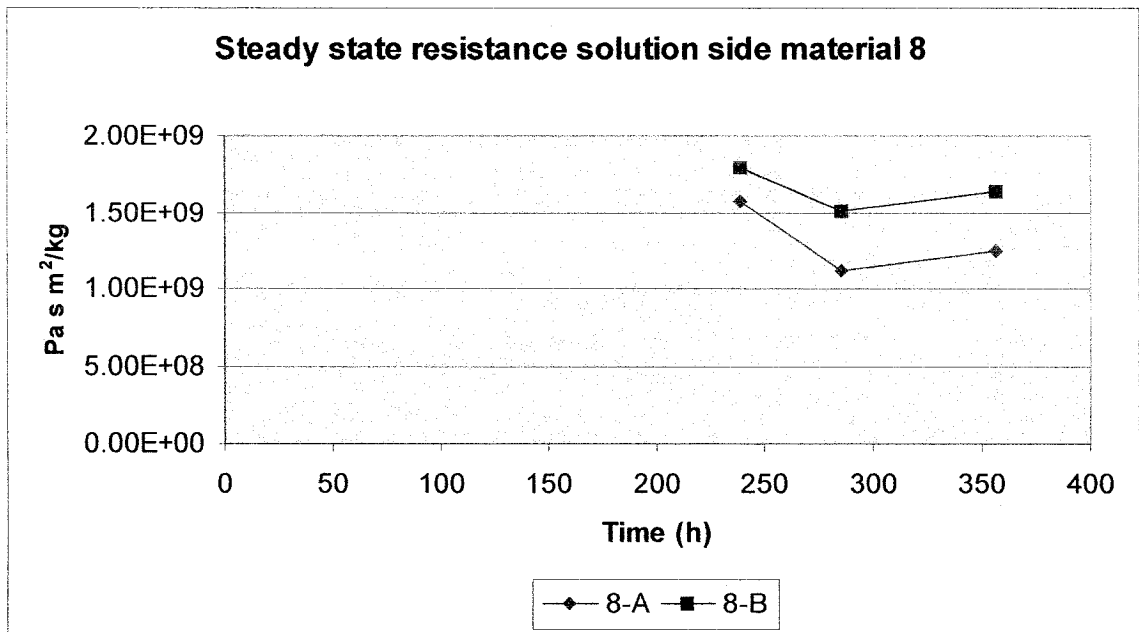
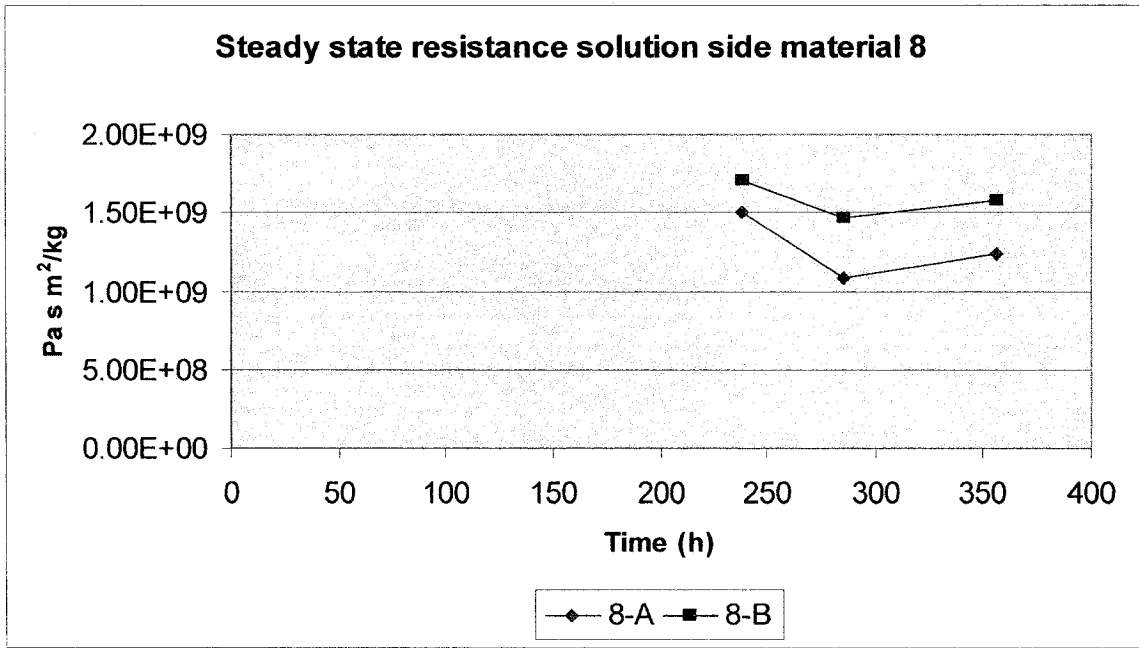

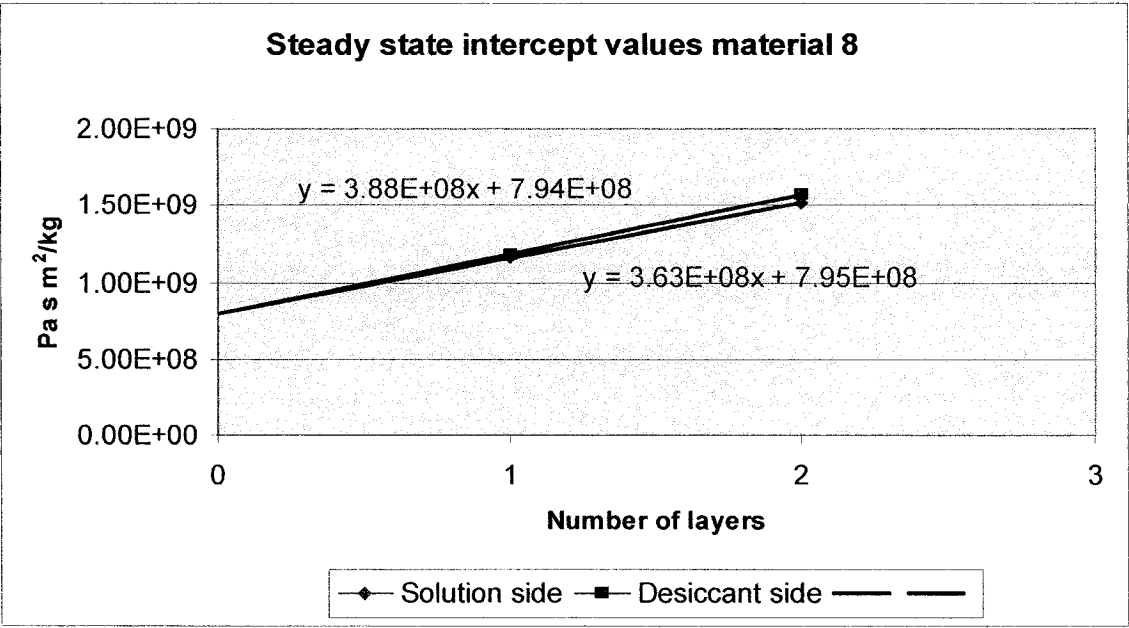

Material P8
 Double cup test method (DC)
 July 4th 2002 - Beginning of test
 Liquid cup: Salt concentration of 75% Relative Humidity
 Temperature control: +/- 1.5 °C

Area of specimen: 0.01327 sq.m.

Thickness of material 8 in mm
 Sample Layer Point 1 Point 2 Point 3 Point 4 Average thickness per layer
 8-A 1 0.19 0.18 0.14 0.19 0.175

Weight of paper in grammes
 8-A 1.62

Table 1.: Recordings of weights for 8-A

Sr. No.	Date	Time		Hours	Wt. Of liquid		Mass (g)		Temp. °C	Relative Humidity %	Pressure difference ΔP	
		Dry Cup	Specimen Cup		New wt. Of Dry Cup	Wt. Of Ring + Specimen	Pa at 100%	Pa at 75%				
1	04/07/2002	15:25	0:00	0.00	1180.175	N/A	943.558	85.905	24.1	49	3004	2252.71
2	06/07/2002	15:25	48:00	48.00	1177.262	944.608	946.377	85.910	23.9	45	2968	2225.80
3	08/07/2002	15:25	48:00	48.00	1174.224	943.489	947.585	85.892	23.6	47	2915	2186.49
4	10/07/2002	15:25	48:00	48.00	1170.590	943.194	947.147	85.904	23.5	46	2898	2173.39
5	12/07/2002	15:25	48:00	48.00	1165.000	943.494	946.425	85.910	26.1	50	3384	2537.78
6	14/07/2002	14:25	47:00	47.00	1161.220	943.639	947.132	85.916	24.2	49	3022	2266.52
7	16/07/2002	12:55	46:50	46.50	1156.577	943.780	948.141	85.903	23.8	52	2950	2212.70
8	19/07/2002	11:55	71:00	71.00	1150.481	N/A	949.804	85.895				

Table 2.: Water Vapour Transmission through material In 5-C

Sr. No.	Weight change in cups		Specimen		Time		Weight change per unit time		q/A		Permeance		Resistance			
	Water Cup	Dry Cup	Water Cup	Dry Cup	Days	Hours	Seconds	dW/dt	dDes/dt	dSp/dt	Solution Side	Desiccant Side	Solution Side	Desiccant Side		
														(Pa.s m ² /kg)		
1	0.000	0.000	0.000	0.000	0	0:00	0	-0.0000169	0.0000163	0.0000000	-0.0000013	0.0000012	5.7074E-10	5.523E-10	1.75E+09	1.81E+09
2	-2.913	2.819	0.005	-0.018	2	48:00	172800	-0.0000176	0.0000172	-0.0000001	-0.0000013	0.0000013	6.0593E-10	5.942E-10	1.65E+09	1.68E+09
3	-3.038	2.979	-0.018	0.012	2	48:00	172800	-0.0000210	0.0000212	0.0000001	-0.0000016	0.0000016	7.2918E-10	7.34E-10	1.37E+09	1.36E+09
4	-3.634	3.658	0.012	-0.006	2	48:00	172800	0.0000303	0.0000305	0.0000000	-0.0000024	0.0000023	9.1114E-10	8.526E-10	1.1E+09	1.17E+09
5	-5.590	5.231	0.006	-0.006	2	47:00	169200	-0.0000223	0.0000215	0.0000000	-0.0000017	0.0000016	6.6339E-10	6.365E-10	1.51E+09	1.57E+09
6	-3.780	3.638	0.006	-0.013	2	47:00	167400	-0.0000277	0.0000269	-0.0000001	-0.0000021	0.0000020	9.2218E-10	8.942E-10	1.08E+09	1.12E+09
7	-4.643	4.502	-0.013	-0.008	2	46:50	167400	-0.0000238	0.0000236	0.0000000	-0.0000018	0.0000018	8.1225E-10	8.027E-10	1.23E+09	1.25E+09
8	-6.096	6.024	-0.008	-0.008	3	71:00	255600	-0.0000238	0.0000236	0.0000000	-0.0000018	0.0000018				
Total Average														1.43E+09	1.46E+09	
Steady state average														1.16E+09	1.18E+09	

Material P8
 Double cup test method (DC)
 July 4th 2002 - Beginning of test
 Liquid cup: Salt concentration of 75% Relative Humidity
 Temperature control: +/- 1.5 °C

Area of specimen: 0.01327 sq.m.

Thickness of material 8 in mm

Sample	Layer	Point 1	Point 2	Point 3	Point 4	Average thickness per layer
8-B	1	0.19	0.2	0.17	0.18	0.185
	2	0.17	0.18	0.19	0.2	0.185
						Average thickness 0.185

Weight of paper in grammes
 8-B
 3.35

Table 1: Recordings of weights for 8-B

Sr. No.	Time		Mass (g)			Temp. °C	Relative Humidity		Pressure difference ΔP	
	Date	Hours	Wt. Of liquid Cup	New wt. Of Dry Cup	Wt. Of Ring + Specimen		Pa at 100%	Pa at 75%		
1	04/07/2002	15:30	0.00	1176.777	N/A	956.779	89.587	24.1	3004	2252.71
2	06/07/2002	15:30	48.00	956.301	956.301	959.536	89.361	23.9	2968	2225.80
3	08/07/2002	15:30	48.00	1171.692	956.416	958.595	89.355	23.6	2915	2186.49
4	10/07/2002	15:30	48.00	1168.927	956.185	959.274	89.349	23.3	2898	2173.39
5	12/07/2002	15:30	48.00	1163.132	956.591	961.496	89.513	48.1	3567	2675.65
6	14/07/2002	14:30	47.00	1159.804	956.025	959.768	89.574	25.8	3384	2537.78
7	16/07/2002	13:00	46.50	1156.356	956.139	959.374	89.549	24.2	3022	2266.52
8	19/07/2002	12:00	71.00	1151.611	N/A	960.722	89.537	23.8	2950	2212.70

Table 2: Water Vapour Transmission through material in 5-D

Sr. No.	Weight change in cups			Time			Weight change per unit time			q/A		Permeance		Resistance	
	Water Cup	Dry Cup	Specimen Cup	Days	Hours	Seconds	dW/dt	dDes/dt	dSp/dt	Solution Side	Desiccant Side	Solution Side	Desiccant Side	Solution Side	Desiccant Side
1	0.000	0.000	0.000	0	0.00	0	-0.0000159	0.0000160	-0.0000013	-0.0000012	0.0000012	5.3763E-10	5.402E-10	1.86E+09	1.851E+09
2	-2.744	2.757	-0.226	2	48.00	172800	-0.0000135	0.0000133	0.0000000	-0.0000010	0.0000010	4.8692E-10	4.575E-10	2.142E+09	2.186E+09
3	-2.341	2.294	-0.006	2	48.00	172800	-0.0000160	0.0000165	0.0000000	-0.0000012	0.0000012	5.6481E-10	5.735E-10	1.802E+09	1.744E+09
4	-2.765	2.858	-0.006	2	48.00	172800	-0.0000197	0.0000188	0.0000004	-0.0000015	0.0000014	8.4495E-10	8.657E-10	1.059E+09	1.155E+09
5	-5.795	5.311	0.164	2	43.00	154800	-0.0000206	0.0000200	-0.0000001	-0.0000016	0.0000015	5.8406E-10	5.576E-10	1.712E+09	1.794E+09
6	-3.328	3.177	0.061	2	47.00	169200	-0.0000186	0.0000179	0.0000000	-0.0000014	0.0000014	6.8483E-10	6.652E-10	1.46E+09	1.503E+09
7	-3.448	3.349	-0.025	2	46.50	167400	-0.0000186	0.0000179	0.0000000	-0.0000014	0.0000014	6.3224E-10	6.107E-10	1.582E+09	1.538E+09
8	-4.745	4.583	-0.012	3	71.00	255600	-0.0000186	0.0000179	0.0000000	-0.0000014	0.0000014	6.3224E-10	6.107E-10	1.582E+09	1.538E+09
										Total Average		1.66E+09		1.696E+09	
										Steady state average		1.521E+09		1.57E+09	

Material P8
Double cup test method (DC)
Liquid cup: Salt concentration of 75% relative humidity
Temperature control: $\pm 2.0^\circ\text{C}$

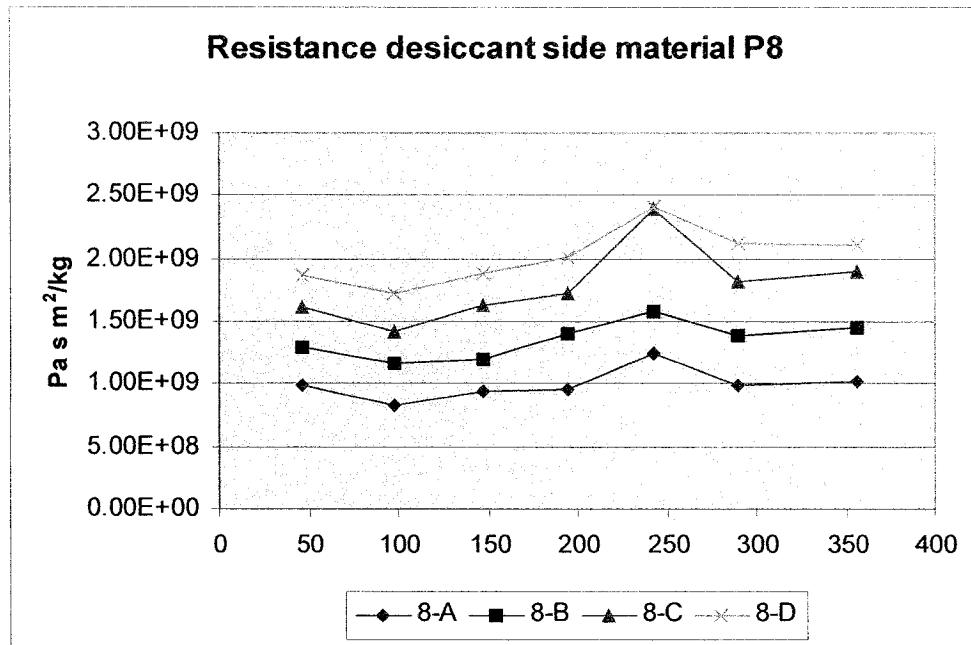
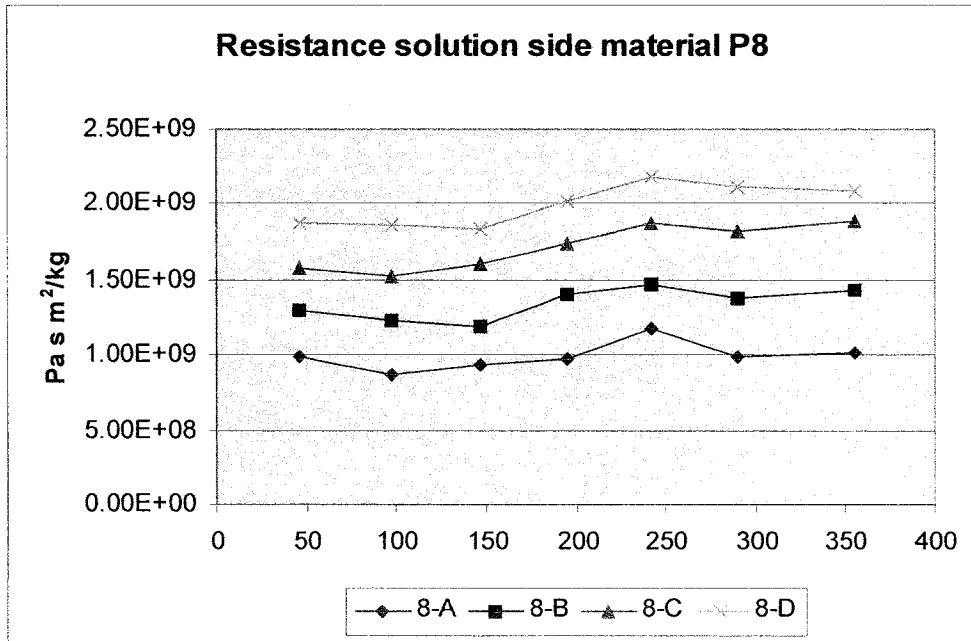

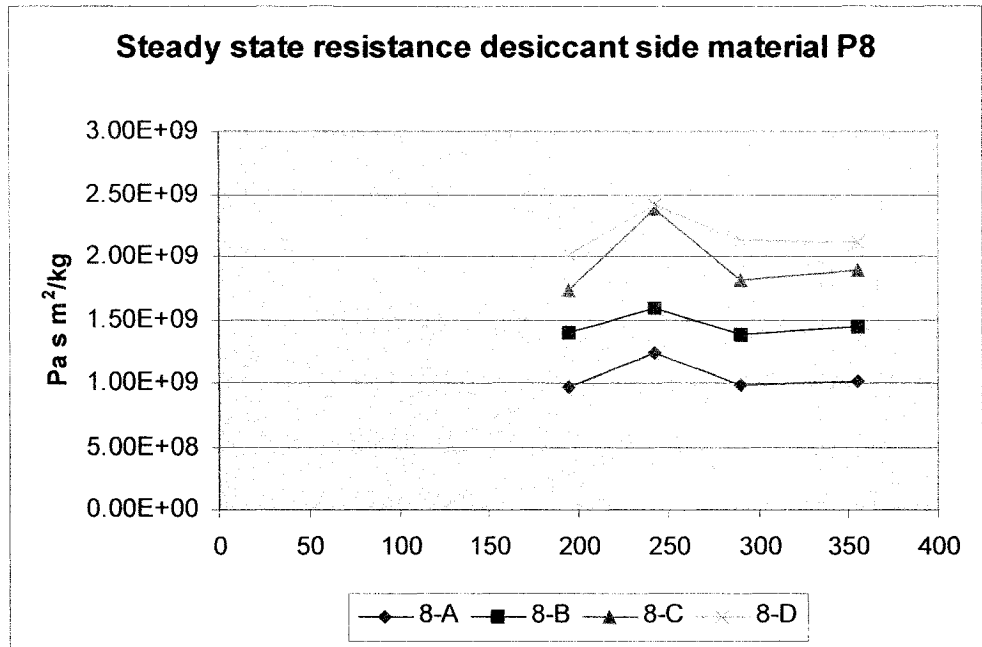
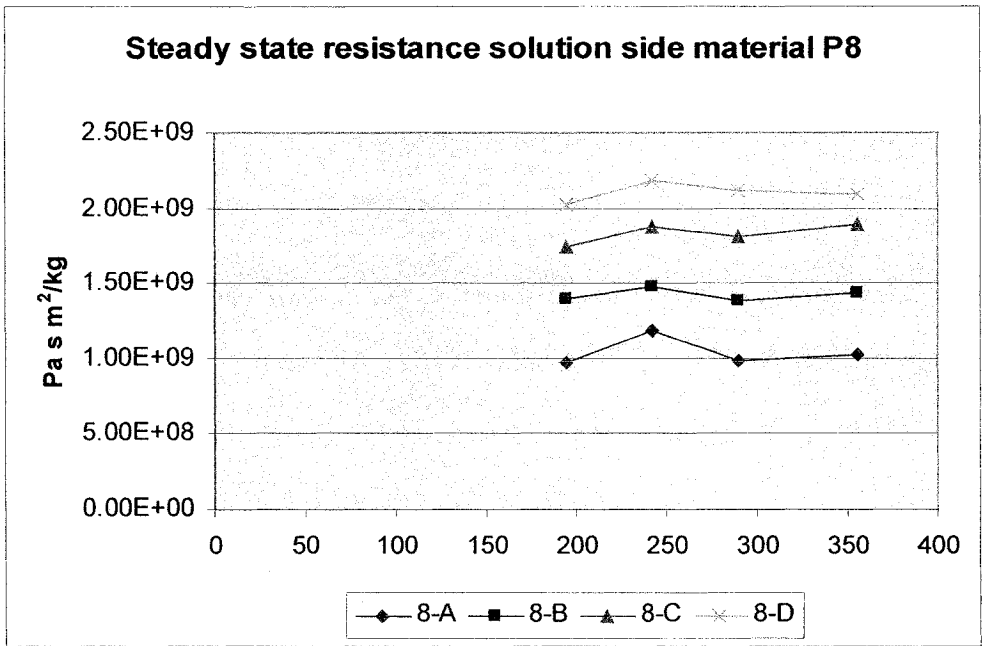

Steady state intercept values material P8

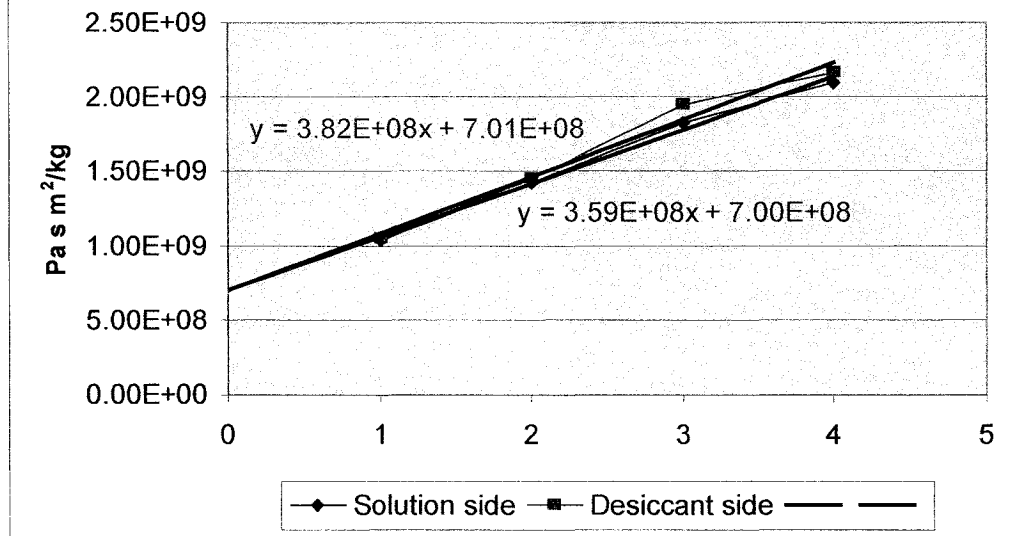

Material P8
 Double cup method (DC)
 Liquid cup: Salt concentration of 75% Relative Humidity
 Jan. 30th 2002 - Beginning of test
 Temperature control: +- 2.0 °C

Area of specimen: 0.01327 sq.m.

Thickness of material P8 in mm

Sample Layer Point 1 Point 2 Point 3 Point 4 Average thickness
 8-A 1 0.18 0.14 0.15 0.16 0.1575

Weight of paper in grammes

8-A 1.734

Table 1.: Recordings of weights for 8-A

Sr. No.	Time		Hours	Wt. Of liquid Cup	Weights (1)		Temp. °C	Barometric Pressure Pa	Relative Humidity %	Pressure difference ΔP	
	Date	Time			New wt. Of Dry Cup	Wt. Of Ring + Specimen				Pa at 100%	Pa at 75%
1	30/01/2002	21:00	0.00	1193.783	N/A	933.066	24.9	1020	43	3151	2363.17
2	01/02/2002	19:10	46.17	1188.525	936.965	938.317	24.8	987	42	3132	2349.36
3	03/02/2002	22:30	51.33	1182.312	935.944	943.431	23.7	999	38	2933	2199.59
4	05/02/2002	0:15	49.75	1176.789	936.293	941.420	23.4	1008	36	2915	2186.49
5	07/02/2002	23:40	47.42	1171.069	933.139	942.059	25.5	998	38	3266	2449.73
6	09/02/2002	23:30	47.83	1165.594	938.406	938.330	26.6	1025	33	3772	2628.63
7	11/02/2002	23:20	47.83	1159.834	968.165	942.161	25.8	1013	34	3325	2493.38
8	14/02/2002	16:40	65.33	1152.204	927.636	975.784	25.8	1010	36	3325	2493.38

Table 2.: Water Vapour Transmission through material in 8-A

Sr. No.	Weight change in cups			Time			Weight change per unit time			q/A		Permeance		Resistance	
	Water Cup	Dry Cup	Specimen	Days	Hours	Seconds	dt/wdt	dDes/dt	dSp/dt	Solution Side	Desiccant Side	Solution Side	Desiccant Side	Solution Side	Desiccant Side
1	0.000	0.000	0.000	0	0.00	0	-0.0000316	0.0000316	0.0000001	-0.0000024	0.0000024	1.0148E-09	1.013E-09	9.85E+08	9.87E+08
2	-5.258	5.251	0.020	2	46.17	166200	-0.0000336	0.0000350	0.0000000	-0.0000025	0.0000026	1.1518E-09	1.199E-09	8.68E+08	8.34E+08
3	-6.213	6.466	-0.007	2	51.33	184800	-0.0000308	0.0000306	0.0000000	-0.0000023	0.0000023	1.0628E-09	1.054E-09	9.41E+08	9.49E+08
4	-5.523	5.476	0.002	2	49.75	179100	-0.0000335	0.0000338	0.0000000	-0.0000025	0.0000025	1.0308E-09	1.039E-09	9.70E+08	9.62E+08
5	-5.720	5.766	-0.008	2	47.42	170700	-0.0000318	0.0000301	0.0000000	-0.0000024	0.0000023	8.4704E-10	8.031E-10	1.18E+09	1.25E+09
6	-5.475	5.191	0.006	2	47.83	172200	-0.0000334	0.0000334	0.0000000	-0.0000025	0.0000025	1.011E-09	1.01E-09	9.89E+08	9.90E+08
7	-5.760	5.755	0.003	2	47.83	172200	-0.0000324	0.0000324	-0.0000001	-0.0000024	0.0000024	9.8046E-10	9.79E-10	1.02E+09	1.02E+09
8	-7.630	7.619	-0.015	3	65.33	235200	-0.0000324	0.0000324	-0.0000001	-0.0000024	0.0000024	9.8046E-10	9.79E-10	1.02E+09	1.02E+09
										Total average		9.93E+08		9.98E+08	
										Steady state average		1.04E+09		1.05E+09	

Material P8
 Double cup method (DC)
 Liquid cup: Salt concentration of 75% Relative Humidity
 Jan. 30th 2002 - Beginning of test
 Temperature control: +- 2.0 °C

Area of specimen: 0.01327 sq.m.

Thickness of material P8 in mm

Sample Layer	Point 1	Point 2	Point 3	Point 4	Average Thickness
1	0.18	0.18	0.17	0.18	0.1775
2	0.23	0.19	0.15	0.2	0.1925
Total Avg.					0.185

Weight of paper in grammes
 8-B 3.312

Table 1.: Recordings of weights for 8-B

Sr. No.	Time		Weights (1)				Temp. °C	Barometric Pressure Pa	Relative Humidity %		Pressure difference Δ P Pa at 100% Pa at 75%	
	Date	Time	Hours	Wt. Of liquid Cup	New wt. Of Dry Cup	Wt. Of Dry Cup			Wt. Of Ring + Specimen	%	Pa at 100%	Pa at 75%
1	30/01/2002	21:00	0.00	1193.468	N/A	933.253	87.905	1020	43	3151	2363.17	
2	01/02/2002	19:15	46.25	1189.453	939.795	937.272	87.896	987	42	3132	2349.36	
3	03/02/2002	22:33	51.30	1185.066	931.300	944.392	87.903	999	38	2933	2199.59	
4	05/02/2002	0:20	49.78	1180.674	960.218	935.624	87.893	1008	36	2915	2186.49	
5	07/02/2002	23:45	47.42	1176.714	930.702	964.173	87.892	998	38	3266	2449.73	
6	09/02/2002	23:35	47.83	1172.319	933.863	934.793	87.877	1025	33	3772	2828.63	
7	11/02/2002	23:25	47.83	1168.188	930.837	937.968	87.885	1013	34	3325	2493.38	
8	14/02/2002	16:45	65.33	1162.747	941.904	936.210	87.881	1010	36	3325	2493.38	

Table 2.: Water Vapour Transmission through material in 8-B

Sr. No.	Weight change in cups			Time			Weight change per unit time			q/A		Permeance		Resistance	
	Water Cup	Dry Cup	Specimen	Days	Hours	Seconds	dW/dt	dDes/dt	dSp/dt	Solution Side	Desiccant side	Solution Side	Desiccant side	Solution Side	Desiccant side
g/s															
(kg/s m ²)															
(kg/Pa s m ²)															
1	0.000	0.000	0.000	0	0.00	0	-0.0000241	0.0000241	-0.0000001	-0.0000018	0.0000018	7.7348E-10	7.743E-10	1.29E+09	1.29E+09
2	-4.015	4.019	-0.009	2	46.25	166500	-0.0000238	0.0000249	0.0000000	-0.0000018	0.0000019	8.1383E-10	8.528E-10	1.23E+09	1.17E+09
3	-4.387	4.597	0.007	2	51.30	184880	-0.0000245	0.0000241	-0.0000001	-0.0000018	0.0000018	8.4461E-10	8.315E-10	1.18E+09	1.20E+09
4	-4.392	4.324	-0.010	2	49.78	179220	-0.0000232	0.0000238	-0.0000001	-0.0000017	0.0000017	7.1363E-10	7.127E-10	1.40E+09	1.40E+09
5	-3.960	3.955	-0.001	2	47.42	170700	-0.0000265	0.0000238	-0.0000001	-0.0000019	0.0000018	6.7995E-10	6.329E-10	1.47E+09	1.58E+09
6	-4.395	4.091	-0.015	2	47.83	172200	-0.0000240	0.0000238	0.0000000	-0.0000018	0.0000018	7.2504E-10	7.205E-10	1.38E+09	1.39E+09
7	-4.131	4.105	0.008	2	47.83	172200	-0.0000231	0.0000228	0.0000000	-0.0000017	0.0000017	6.9917E-10	6.904E-10	1.43E+09	1.48E+09
8	-5.441	5.373	-0.004	3	65.33	235200	-0.0000231	0.0000228	0.0000000	-0.0000017	0.0000017	6.9917E-10	6.904E-10	1.43E+09	1.48E+09
Total average														1.34E+09	1.35E+09
Steady state average														1.42E+09	1.46E+09

Material P8
 Double cup method (DC)
 Liquid cup: Salt concentration of 75% Relative Humidity
 Jan. 30th 2002 - Beginning of test
 Temperature control: +/- 2.0 °C

Area of specimen: 0.01327 sq.m.

Thickness of material P8 in mm
 Sample Layer Point 1 Point 2 Point 3 Point 4
 8-C 1 0.16 0.16 0.21 0.17
 2 0.16 0.18 0.18 0.15
 3 0.2 0.19 0.17 0.17
 Total Avg. 0.175

Average Thickness
 0.175
 0.1675
 0.1825
 0.175

Weight of paper in grammes
 8-C 4.938

Table 1: Recordings of weights for 8-C

Sr. No.	Time		Weights (1)				Temp. °C	Barometric Pressure Pa	Relative Humidity %		Pressure difference ΔP	
	Date	Time	Hours	Wt. Of liquid Cup	New wt. Of Dry Cup	Wt. Of Dry Cup			Wt. Of Ring + Specimen	Pa at 100%	Pa at 75%	
1	30/01/2002	21:10	0.00	1192.888	N/A	905.637	90.487	24.9	1020	43	3151	2363.17
2	01/02/2002	19:20	46.17	1189.609	909.972	908.843	90.464	24.8	987	42	3132	2349.36
3	03/02/2002	22:35	51.25	1186.063	898.848	913.752	90.452	23.7	999	38	2933	2199.59
4	05/02/2002	0:25	49.83	1182.806	946.223	902.051	90.460	23.4	1008	36	2915	2186.49
5	07/02/2002	23:50	47.42	1179.613	933.947	949.434	90.454	25.5	998	38	3266	2449.73
6	09/02/2002	23:40	47.83	1176.166	901.129	936.653	90.445	26.6	1025	33	3772	2828.63
7	11/02/2002	23:30	47.83	1173.022	900.589	904.273	90.445	25.8	1013	34	3325	2493.38
8	14/02/2002	16:50	65.33	1168.901	925.804	904.702	90.444	25.8	1010	36	3325	2493.38

Table 2: Water Vapour Transmission through material in 8-C

Sr. No.	Weight change in cups		Time			Weight change per unit time			q/A		Permeance		Resistance		
	Water Cup	Dry Cup	Specimen	Days	Hours	Seconds	dW/dt	dDes/dt	dSp/dt	Solution Side	Desiccant Side	Solution Side	Desiccant Side	Solution Side	Desiccant Side
1	0.000	0.000	0.000	0	0.00	0	-0.0000197	0.0000193	-0.0000001	0.0000015	0.0000015	6.3283E-10	6.187E-10	1.58E+09	1.62E+09
2	-3.279	3.206	-0.023	2	46.17	166200	-0.0000192	0.0000205	-0.0000001	0.0000014	0.0000015	6.5846E-10	7.019E-10	1.52E+09	1.42E+09
3	-3.546	3.780	-0.012	2	51.25	184500	-0.0000182	0.0000179	0.0000000	0.0000014	0.0000013	6.2572E-10	6.163E-10	1.60E+09	1.63E+09
4	-3.257	3.203	0.008	2	49.83	179400	-0.0000187	0.0000188	0.0000000	0.0000014	0.0000014	5.7541E-10	5.787E-10	1.74E+09	1.73E+09
5	-3.193	3.211	-0.009	2	47.42	170700	-0.0000200	0.0000157	-0.0000001	0.0000015	0.0000012	5.3329E-10	4.186E-10	1.88E+09	2.39E+09
6	-3.447	2.706	-0.009	2	47.83	172200	-0.0000183	0.0000183	0.0000000	0.0000014	0.0000014	5.5181E-10	5.518E-10	1.81E+09	1.81E+09
7	-3.144	3.144	0.000	2	47.83	172200	-0.0000175	0.0000175	0.0000000	0.0000013	0.0000013	5.2955E-10	5.285E-10	1.89E+09	1.89E+09
8	-4.121	4.113	-0.001	3	65.33	235200	-0.0000175	0.0000175	0.0000000	0.0000013	0.0000013	5.2955E-10	5.285E-10	1.89E+09	1.89E+09
Total average											1.72E+09	1.68E+09			
Steady state average											1.83E+09	1.86E+09			

Material P8
 Double cup method (DC)
 Liquid cup: Salt concentration of 75% Relative Humidity
 Jan. 30th 2002 - Beginning of test
 Temperature control: +/- 2.0 °C

Area of specimen: 0.01327 sq.m.
 Thickness of material P8 in mm
 Sample Layer Point 1 Point 2 Point 3 Point 4 Average thickness
 8-D 1 0.16 0.18 0.19 0.18 0.1775
 2 0.18 0.17 0.17 0.18 0.175
 3 0.19 0.15 0.19 0.16 0.1725
 4 0.16 0.19 0.19 0.25 0.1975
 Total avrg. 0.723

Weight of paper in grammes
 8-D 6.666

Table 1.: Recordings of weights for 8-D

Sr. No.	Time		Weights (1)				Temp. °C	Barometric Pressure Pa	Relative Humidity %	Pressure difference ΔP	
	Date	Time	Hours	Wt. Of liquid Cup	New wt. Of Dry Cup	Wt. Of Ring + Specimen				Pa at 100%	Pa at 75%
1	30/01/2002	21:05	0.00	1193.515	N/A	934.704	24.9	1020	43	3151	2363.17
2	01/02/2002	19:25	46.33	1190.743	944.331	937.483	24.8	987	42	3132	2349.36
3	03/02/2002	22:40	51.25	1187.852	936.142	947.446	23.7	999	38	2933	2199.59
4	05/02/2002	0:30	49.83	1185.000	941.783	938.900	23.4	1008	36	2915	2186.49
5	07/02/2002	23:55	47.42	1182.247	942.530	944.545	25.5	998	38	3266	2449.73
6	09/02/2002	23:45	47.83	1179.282	950.876	945.211	26.6	1025	33	3772	2828.63
7	11/02/2002	23:35	47.83	1176.583	935.599	953.559	25.8	1013	34	3325	2493.38
8	14/02/2002	16:55	65.33	1172.862	941.481	939.295	25.8	1010	36	3325	2493.38

Table 2.: Water Vapour Transmission through material in 8-D

Sr. No.	Weight change in cups		Time			Weight change per unit time		q/A		Permeance		Resistance			
	Water Cup	Dry Cup	Specimen	Days	Hours	Seconds	dW/dt (g/s)	dDes/dt (g/s)	dSp/dt (kg/s m ²)	Solution Side	Desiccant Side	Solution Side	Desiccant Side		
1	0.000	0.000	0.000	0	0.00	0	-0.0000166	0.0000167	-0.0000001	0.0000013	0.0000013	5.331E-10	5.344E-10	1.88E+09	1.87E+09
2	-2.772	2.779	-0.010	2	46.33	166800	0.0000157	0.0000169	0.0000001	0.0000013	0.0000013	5.368E-10	5.784E-10	1.86E+09	1.73E+09
3	-2.891	3.115	0.015	2	51.25	184500	-0.0000159	0.0000154	0.0000000	0.0000012	0.0000012	5.479E-10	5.299E-10	1.83E+09	1.89E+09
4	-2.852	2.758	-0.005	2	49.83	179400	-0.0000161	0.0000162	0.0000000	0.0000012	0.0000012	4.961E-10	4.977E-10	2.02E+09	2.01E+09
5	-2.753	2.762	0.002	2	47.42	170700	-0.0000172	0.0000156	-0.0000001	0.0000013	0.0000012	4.587E-10	4.148E-10	2.18E+09	2.41E+09
6	-2.965	2.681	-0.010	2	47.83	172200	-0.0000157	0.0000156	0.0000000	0.0000012	0.0000012	4.737E-10	4.709E-10	2.11E+09	2.12E+09
7	-2.699	2.683	0.002	2	47.83	172200	-0.0000158	0.0000157	0.0000000	0.0000012	0.0000012	4.781E-10	4.749E-10	2.09E+09	2.18E+09
8	-3.721	3.696	-0.005	3	65.33	235200	-0.0000157	0.0000157	0.0000000	0.0000012	0.0000012	4.781E-10	4.749E-10	2.09E+09	2.18E+09
										Total average		1.99E+09		2.02E+09	
										Steady state average		2.10E+09		2.16E+09	

Material P8
Double cup test method (DC)
Liquid cup: Magnesium nitrate hexahydrate, 52% relative humidity
Temperature control: $\pm 1.5^{\circ}\text{C}$

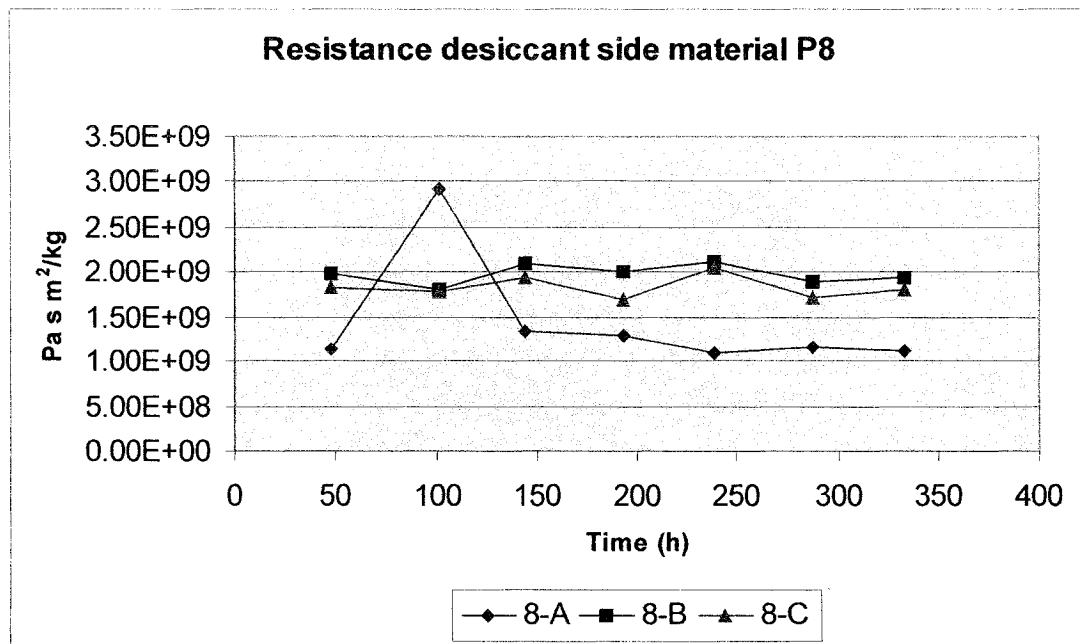
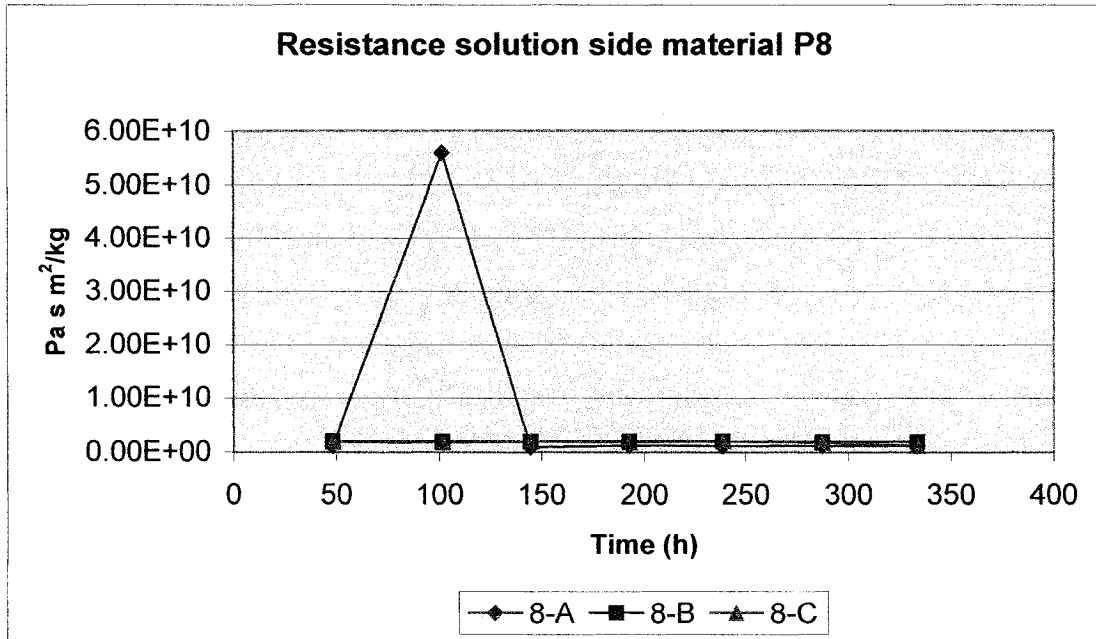

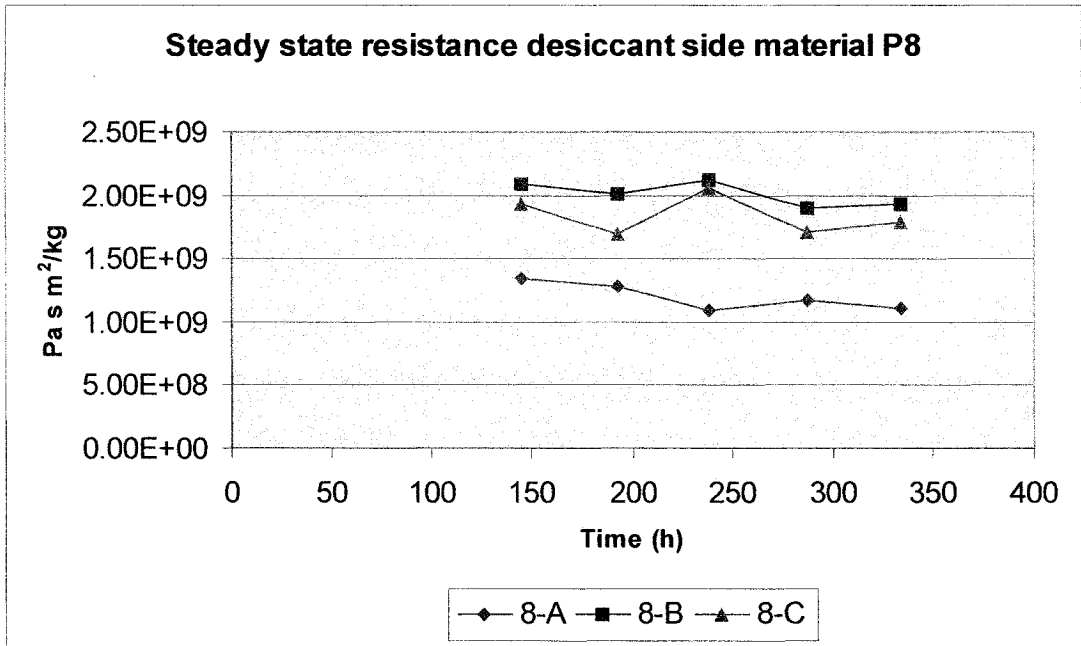
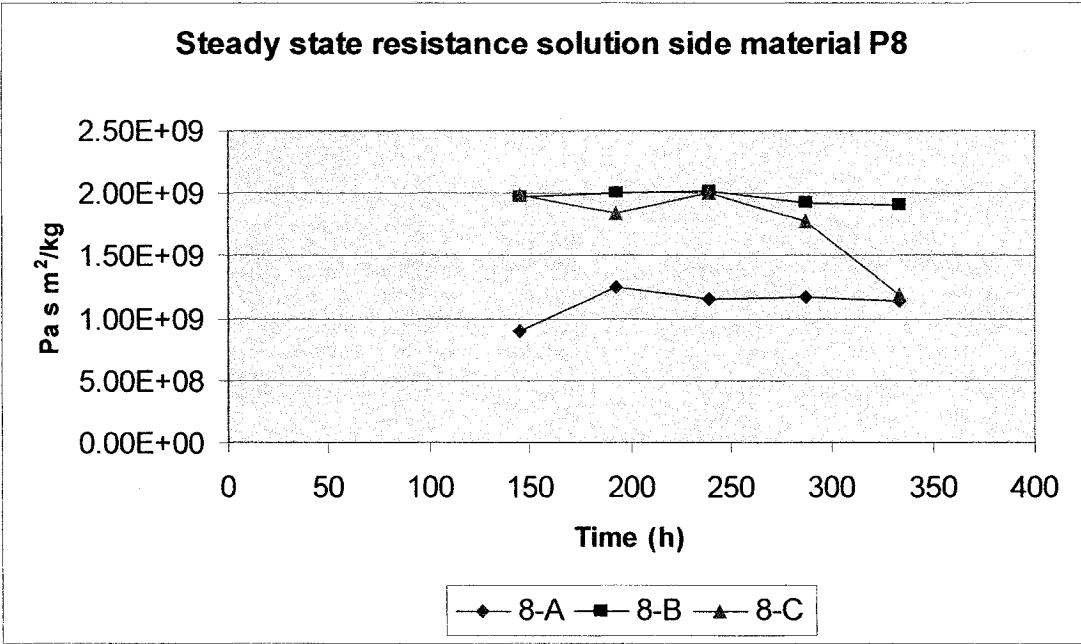

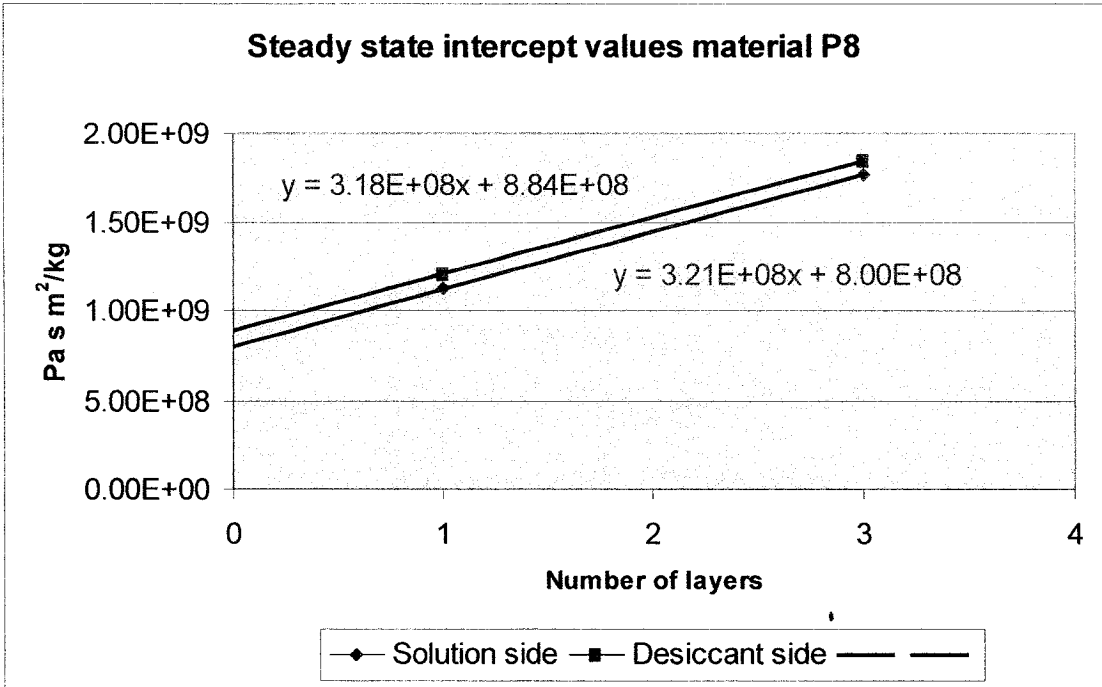
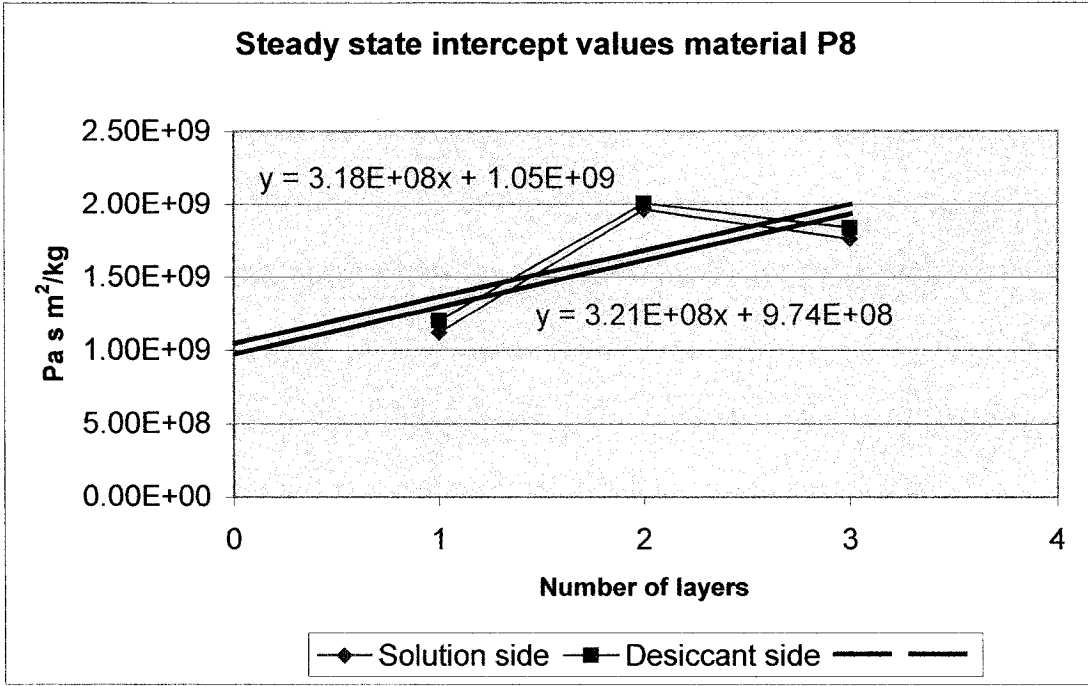

Material P8
 Double cup test method (DC)
 Liquid cup: Magnesium nitrate hexahydrate, 52% Relative Humidity
 August 7th 2002 - Beginning of test
 Temperature control: +/- 1.5 °C

Area of specimen: 0.01327 sq.m.

Thickness of material P8 in mm

Sample Layer Point 1 Point 2 Point 3 Point 4 Average thickness
 8-A 1 0.17 0.19 0.16 0.19 0.1775

Weight of paper in grammes
 8-A 1.65

Table 1.: Recordings of weights for 8-A

Sr. No.	Time		Hours	Weights (1)		Temp. °C	Relative Humidity %	Pressure difference ΔP	
	Date	Time		Wt. Of liquid Cup	New wt. Of Dry Cup			Wt. Of Ring + Specimen	Pa at 100%
1	07/08/2002	14:20	0.00	1056.860	N/A	23.1	44	2898	1507
2	09/08/2002	14:25	48.08	1053.900	947.310	23.4	47	2880	1498
3	11/08/2002	19:55	53.50	1053.830	947.130	23.8	49	2950	1534
4	13/08/2002	14:55	43.00	1050.120	944.880	24.7	56	3114	1619
5	15/08/2002	15:05	48.17	1047.040	945.000	25.8	55	3208	1668
6	17/08/2002	14:05	46.00	1043.970	947.080	24.8	49	3114	1619
7	16/07/2002	14:35	48.50	1040.855	945.020	24.2	44	3022	1571
8	19/07/2002	12:05	46.50	1037.880	N/A	23.6	45	2915	1516

Table 2.: Water Vapour Transmission through material in 8-A

Sr. No.	Weight change in cups			Time			Weight change per unit time			q/A		Permeance		Resistance	
	Water Cup	Dry Cup	Specimen Cup	Days	Hours	Seconds	dW/dt	dDes/dt	dSp/dt	Solution Side	Desiccant Side	Solution Side	Desiccant Side	Solution Side	Desiccant Side
1	0.000	0.000	0.000	0	0.00	0	-0.0000172	0.0000176	-0.0000002	-0.0000013	0.0000013	8.6615E-10	8.865E-10	1.155E+09	1.128E+09
2	-2.980	3.050	-0.040	2	48.08	173100	-0.0000004	0.0000070	-0.0000001	0.0000000	0.0000005	1.7853E-11	3.418E-10	5.601E+10	2.926E+09
3	-0.070	1.340	-0.020	2	53.50	192600	-0.0000240	0.0000160	0.0000001	-0.0000018	0.0000012	1.1153E-09	7.425E-10	8.97E+08	1.347E+09
4	-3.710	2.470	0.010	2	43.00	154800	-0.0000178	0.0000172	-0.0000001	-0.0000013	0.0000013	8.0239E-10	7.776E-10	1.246E+09	1.288E+09
5	-3.080	2.985	-0.020	2	48.17	173400	-0.0000185	0.0000196	0.0000003	-0.0000014	0.0000015	8.6273E-10	9.133E-10	1.59E+09	1.095E+09
6	-3.070	3.250	0.050	2	46.00	165600	-0.0000178	0.0000178	-0.0000001	-0.0000013	0.0000013	8.5554E-10	8.555E-10	1.69E+09	1.69E+09
7	-3.115	3.115	-0.025	2	48.50	174600	-0.0000178	0.0000178	-0.0000001	-0.0000013	0.0000014	8.8343E-10	8.968E-10	1.32E+09	1.15E+09
8	-2.975	3.020	0.005	3	46.50	167400	-0.0000178	0.0000180	0.0000000	-0.0000013	0.0000013	8.8343E-10	8.968E-10	1.126E+09	1.435E+09
Total Average															
Steady state average															

Material P8
 Double cup test method (DC)
 Liquid cup: Magnesium nitrate hexahydrate, 52% Relative Humidity
 October 18th 2002 - Beginning of test
 Temperature control: $\pm 1.5^\circ\text{C}$

Area of specimen: 0.01327 sq.m.
 Thickness of material P8 in mm
 Sample Layer Point 1 Point 2 Point 3 Point 4 Average thickness
 8-B 1 0.15 0.15 0.16 0.17 0.1575
 2 0.15 0.16 0.14 0.15 0.150
 Total avg thickness 0.15375

Weight of paper in grammes
 8-B 3.369

Table 1: Recordings of weights for 8-B

Sr. No.	Time		Hours	Weights (1)		Temp. °C	Relative Humidity %	Pressure difference ΔP	
	Date	Time		Wt. Of liquid Cup	New wt. Of Dry Cup			Wt. Of Ring + Specimen	Pa at 100%
1	18/10/2002	15:55	0.00	1042.716	n/a	25	20	3169	1648
2	20/10/2002	18:35	50.67	1040.645	943.657	26	23	3363	1749
3	22/10/2002	17:00	46.42	1038.655	944.200	26	22	3363	1749
4	24/10/2002	17:00	48.00	1036.732	942.914	25	21	3169	1648
5	26/10/2002	16:30	47.50	1034.872	945.864	25	23	3169	1648
6	28/10/2002	16:30	49.00	1032.958	944.710	25	23	3169	1648
7	30/10/2002	17:00	49.50	1030.928	943.814	25	18	3169	1648
8	01/11/2002	17:30	48.50	1028.938	0.000	24	22	3151	1638

Daylight savings time one hour added

Table 2: Water Vapour Transmission through material in 8-B

Sr. No.	Weight change in cups		Time		Weight change per unit time		q/A		Permeance		Resistance		
	Water Cup	Dry Specimen Cup	Days	Hours	dW/dt	dDes/dt (g/s)	Solution Side	Desiccant Side	Solution Side	Desiccant Side	Solution Side	Desiccant Side	
1	0.000	0.000	0	0.00	-0.0000114	0.0000117	-0.0000009	0.0000009	4.8923E-10	5.053E-10	2.044E+09	1.979E+09	
2	-2.071	2.139	2	50.67	-0.0000119	0.0000129	-0.0000009	0.0000010	5.1314E-10	5.544E-10	1.949E+09	1.804E+09	
3	-1.990	2.150	2	46.42	-0.0000111	0.0000105	-0.0000008	0.0000008	5.0886E-10	4.7896E-10	1.965E+09	2.086E+09	
4	-1.923	1.810	3	48.00	-0.0000109	0.0000109	-0.0000008	0.0000008	4.9737E-10	4.9951E-10	2.011E+09	2.002E+09	
5	-1.860	1.868	2	47.50	-0.0000109	0.0000103	-0.0000008	0.0000008	4.9614E-10	4.71E-10	2.016E+09	2.123E+09	
6	-1.914	1.817	3	49.00	-0.0000114	0.0000116	-0.0000009	0.0000009	5.209E-10	5.2859E-10	1.92E+09	1.892E+09	
7	-2.030	2.060	2	49.50	-0.0000114	0.0000112	-0.0000009	0.0000009	5.2421E-10	5.1736E-10	1.908E+09	1.933E+09	
8	-1.990	1.964	2	48.50	-0.0000114	0.0000112	-0.0000009	0.0000009	5.2421E-10	5.1736E-10	1.908E+09	1.933E+09	
Total Average										1.973E+09	1.974E+09		
Steady state average										1.964E+09	2.008E+09		

Material P8
 Double cup test method (DC)
 Liquid cup: Magnesium nitrate hexahydrate, 52% Relative Humidity
 August 23rd 2002 - Beginning of test
 Temperature control: +/- 1.5 °C

Area of specimen: 0.01327 sq.m.

Thickness of material P8 in mm
 Sample Layer Point 1 Point 2 Point 3 Point 4 Average thickness
 8-C 1 0.15 0.16 0.19 0.19 0.173
 2 0.16 0.16 0.17 0.19 0.170
 3 0.16 0.17 0.16 0.19 0.170
 Total avg thickness 0.171

Weight of paper in grammes
 8-C 4.88

Table 1: Recordings of weights for 8-C

Sr. No.	Date		Time		Weights (1)				Temp. °C	Relative Humidity %	Pressure difference ΔP	
	Time	Hours	Wt. Of liquid Cup	New wt. Of Dry Cup	Wt. Of Dry Cup	Wt. Of Ring + Specimen	Pa at 100%	Pa at 52%				
1	27/08/2002	16:30	47.75	1034.690	n/a	944.755	90.721	24.7	45	2950	1534	
2	29/08/2002	13:30	45.00	1032.992	943.991	946.541	90.727	23.6	46	2915	1516	
3	31/08/2002	12:15	46.75	1031.101	948.383	945.868	90.735	23.4	43	2880	1498	
4	03/09/2002	19:05	79.50	1028.200	979.380	951.362	90.728	23.6	45	2915	1516	
5	05/09/2002	15:40	44.00	1026.483	943.741	981.256	90.745	23.5	40	2898	1507	
6	07/09/2002	14:10	46.50	1024.805	945.172	945.376	90.720	23.6	46	2915	1516	
7	09/09/2002	16:10	48.00	1022.878	944.053	947.174	90.731	22.6	44	2860	1498	
8	11/09/2002	15:10	47.00	1020.000	943.768	945.961	90.725	23.7	46	2933	1525	

Table 2: Water Vapour Transmission through material in 8-C

Sr. No.	Weight change in cups			Time			Weight change per unit time			q/A		Permeance		Resistance	
	Water Cup	Dry Cup	Specimen Cup	Days	Hours	Seconds	dW/dt	dDes/dt	dSpr/dt	Solution Side	Desiccant Side	Solution Side	Desiccant Side	Solution Side	Desiccant Side
1	0.000	0.000	0.000	0	0.00	0	-0.0000105	0.0000110	0.0000000	-0.0000008	0.0000008	5.2103E-10	5.4803E-10	1.92E+09	1.82E+09
2	-1.698	1.786	0.006	2	45.00	162000	-0.0000112	0.0000112	0.0000000	-0.0000008	0.0000008	5.6531E-10	5.6112E-10	1.77E+09	1.78E+09
3	-1.891	1.877	0.008	2	46.75	168300	-0.0000101	0.0000104	0.0000000	-0.0000008	0.0000008	5.0387E-10	5.1742E-10	1.98E+09	1.93E+09
4	-2.901	2.979	-0.009	3	79.50	286200	-0.0000108	0.0000118	0.0000001	-0.0000008	0.0000009	5.4208E-10	5.9228E-10	1.84E+09	1.69E+09
5	-1.717	1.876	0.019	2	44.00	158400	-0.0000100	0.0000098	-0.0000001	-0.0000008	0.0000007	4.9828E-10	4.8551E-10	2.01E+09	2.06E+09
6	-1.678	1.635	-0.025	2	46.50	167400	-0.0000112	0.0000116	0.0000001	-0.0000008	0.0000009	5.6107E-10	5.8299E-10	1.78E+09	1.72E+09
7	-1.927	2.002	0.011	2	48.00	172800	-0.0000170	0.0000113	0.0000000	-0.0000013	0.0000008	8.405E-10	5.5721E-10	1.19E+09	1.79E+09
8	-2.878	1.908	-0.006	2	47.00	169200	-0.0000170	0.0000113	0.0000000	-0.0000013	0.0000008	8.405E-10	5.5721E-10	1.79E+09	1.83E+09
										Total Average		1.76E+09		1.84E+09	
										Steady state average		1.76E+09		1.84E+09	

Material C4
Double cup test method (DC)
Liquid cup: Water, 100% relative humidity
Temperature control: $\pm 2.0^{\circ}\text{C}$

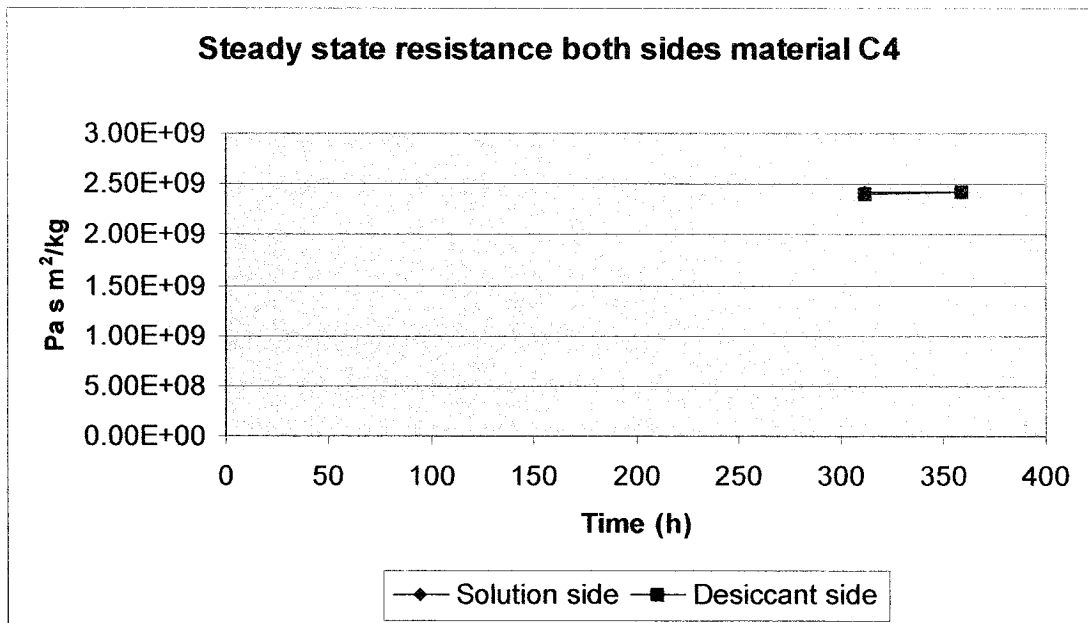
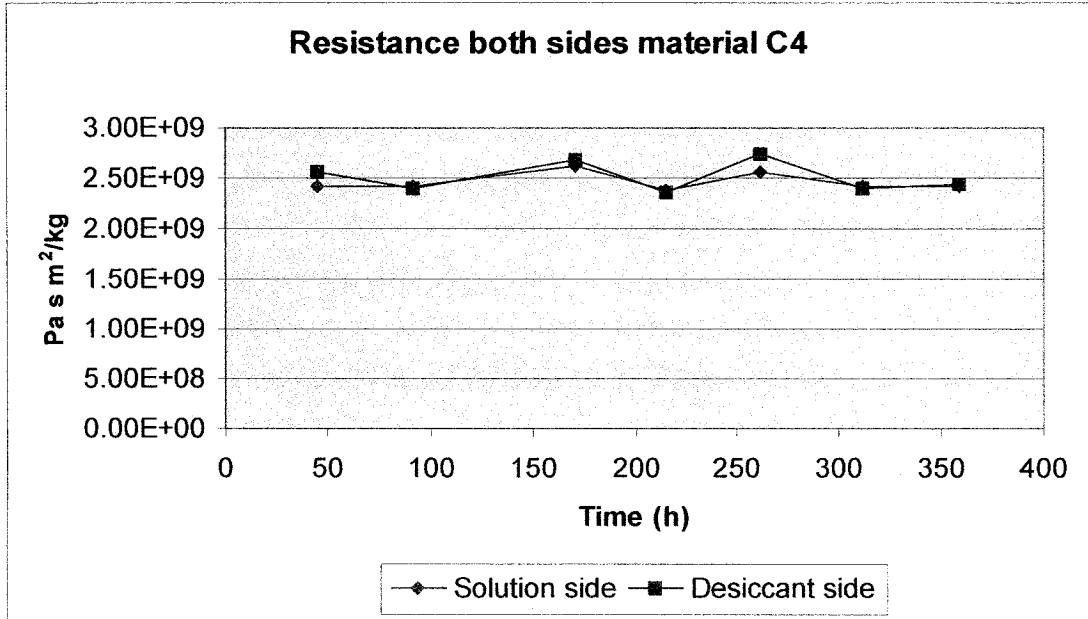

Material C4

Double cup test method (DC)
Liquid cup: Water, 100% R.H.
August 23rd 2002 - Beginning of test
Temperature control: ± 2.0 °C

Area of specimen: 0.01327 sq.m.

Thickness of material C4 in mm:

Sample Layer	Point 1	Point 2	Point 3	Point 4	Average thickness
4-A	1	0.34	0.35	0.36	0.348

Weight of paper in grammes

4-A

Table 1: Recordings of weights for 4-A

Sr. No.	Time		Weights (1)				Temp. °C	Relative Humidity %	Pressure difference Δ P
	Date	Time	Hours	Wt. Of liquid Cup	New wt. Of Dry Cup	Wt. Of Ring + Specimen			
1	27/08/2002	16:35	0:00	1040.271	n/a	921.644	25.8	45	2950
2	29/08/2002	13:35	45:00	1037.683	921.022	924.090	23.6	46	2915
3	31/08/2002	12:20	46:75	1035.030	920.678	923.692	23.4	43	2880
4	03/09/2002	19:10	79:50	1030.807	919.706	924.801	23.6	45	2915
5	09/09/2002	15:10	44:00	1028.239	920.388	922.291	23.5	40	2898
6	07/09/2002	14:40	46:50	1025.716	922.452	922.746	23.6	46	2915
7	09/09/2002	16:40	50:00	1022.870	922.165	925.315	22.9	44	2880
8	11/09/2002	15:40	47:00	1020.152	921.850	924.873	23.7	46	2933

Table 2: Water Vapour Transmission through material in 4-A

Sr. No.	Weight change in cups			Time			Weight change per unit time			g/A		Permeance		Resistance	
	Water Cup	Dry Cup	Specimen Cup	Days	Hours	Seconds	dW/dt	dDes/dt	dSp/dt	Solution Side	Desiccant Side	Solution Side	Desiccant Side	Solution Side	Desiccant Side
(kg/Pa s m ²)															
1	0.000	0.000	0.000	0	0:00	0	-0.0000160	0.0000151	0.0000001	-0.0000012	0.0000011	4.129E-10	3.903E-10	2.42E+09	2.56E+09
2	-2.588	2.446	0.011	2	45:00	162000	-0.0000158	0.0000159	0.0000001	-0.0000012	0.0000012	4.124E-10	4.151E-10	2.42E+09	2.41E+09
3	-2.653	2.670	0.010	2	46:75	168300	-0.0000148	0.0000144	0.0000002	-0.0000011	0.0000011	3.814E-10	3.724E-10	2.62E+09	2.69E+09
4	-4.223	4.123	0.055	2	79:50	286200	-0.0000162	0.0000163	-0.0000003	-0.0000012	0.0000012	4.216E-10	4.244E-10	2.37E+09	2.36E+09
5	-2.568	2.585	-0.040	2	44:00	158400	-0.0000151	0.0000141	0.0000002	-0.0000011	0.0000011	3.896E-10	3.844E-10	2.57E+09	2.74E+09
6	-2.523	2.360	0.026	3	46:50	167400	-0.0000158	0.0000159	-0.0000001	-0.0000012	0.0000012	4.137E-10	4.161E-10	2.42E+09	2.40E+09
7	-2.846	2.863	-0.016	2	50:00	180000	-0.0000161	0.0000160	0.0000000	-0.0000012	0.0000012	4.128E-10	4.112E-10	2.42E+09	2.43E+09
8	-2.718	2.708	0.006	2	47:00	169200	-0.0000161	0.0000160	0.0000000	-0.0000012	0.0000012	Total average		2.481E+09	2.551E+09
Steady state average												2.42E+09	2.42E+09		

Material C4
Double cup test method (DC)
Liquid cup: Salt concentration of 75% relative humidity
Temperature control: $\pm 2.0^{\circ}\text{C}$

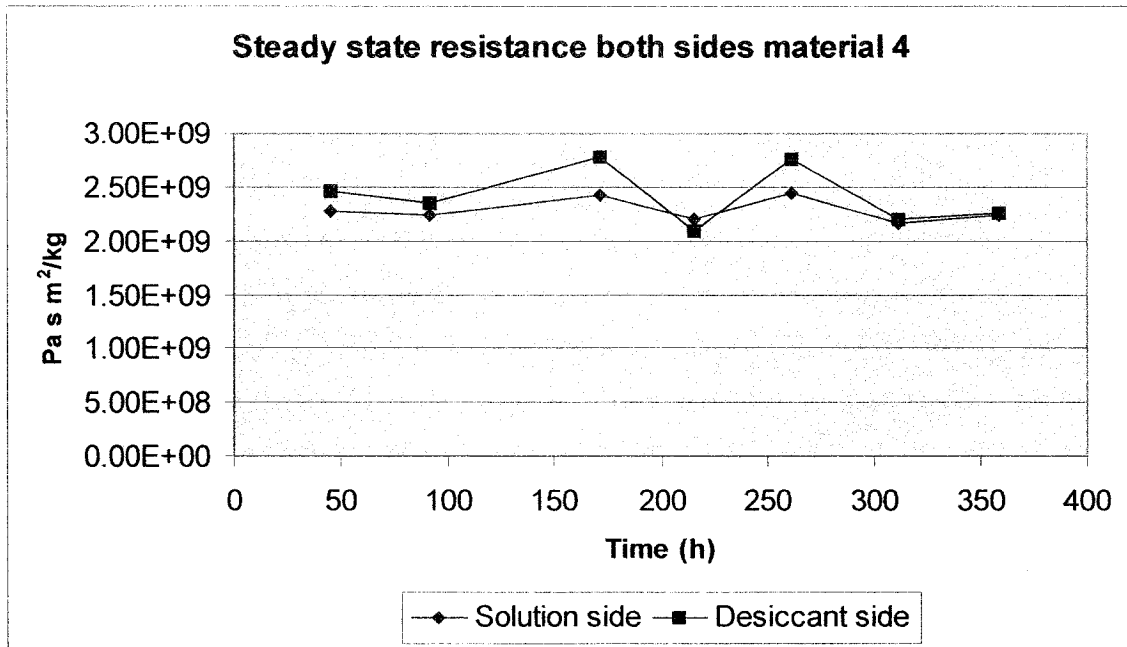
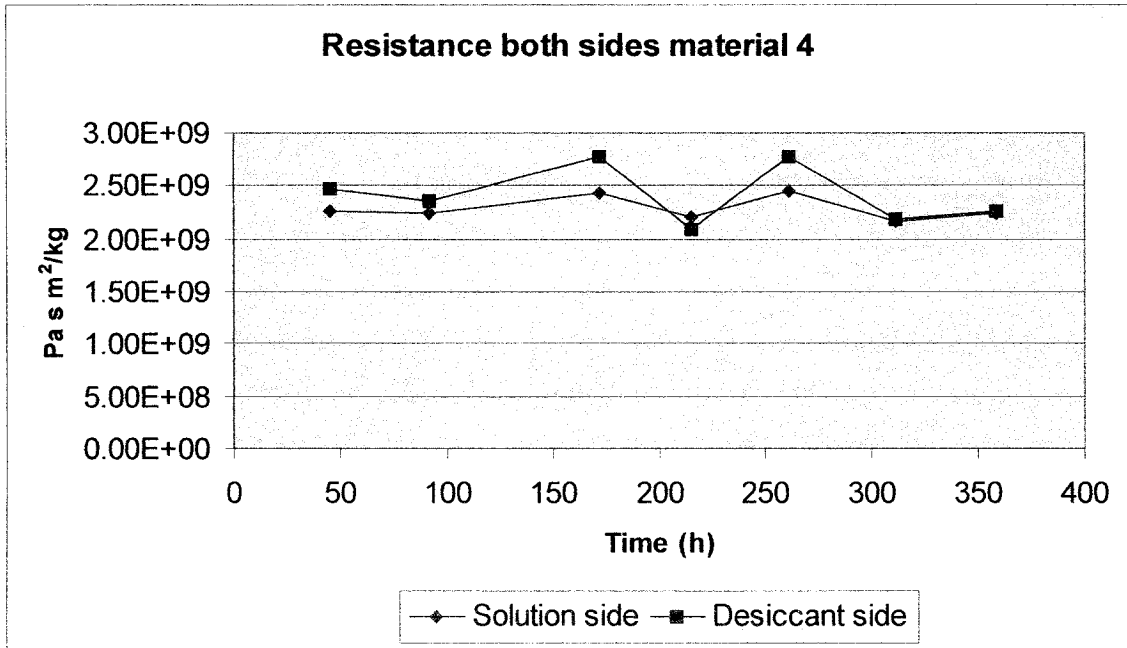

Material C4
 Double cup method (DC)
 August 23rd 2002 - Beginning of test
 Liquid cup: Salt concentration of 75% Relative Humidity
 Temperature control: +- 2.0 °C

Area of specimen: 0.01327 sq.m.

Thickness of material 4 in mm

Sample Layer 1 Point 1 0.35 Point 2 0.35 Point 3 0.35 Point 4 0.36 Average thickness 0.3525

Weight of paper in grammes
 4-A 5.66

Table 1: Recordings of weights for 4-A

Sr. No.	Date	Time		Hours	Weights (1)		Wt. Of Ring + Specimen	Temp. °C	Relative Humidity %	Pressure difference Δ P	
		Dry Cup	Wt. Of liquid Cup		New wt. Of Dry Cup	Cup				Pa at 100%	Pa at 75%
1	27/08/2002	16:45	1052.342	0.00	n/a	961.321	91.390	23.8	45	2950	2212.70
2	29/08/2002	13:45	1050.268	45.00	957.559	963.228	91.389	23.6	46	2915	2186.49
3	31/08/2002	12:30	1048.113	46:75	957.789	959.616	91.396	23.4	43	2880	2160.29
4	03/09/2002	19:00	1044.689	79:50	960.261	960.779	91.409	25.9	45	2915	2186.49
5	05/09/2002	16:00	1042.613	44:00	957.677	962.457	91.398	23.6	40	2898	2173.39
6	07/09/2002	14:30	1040.628	46:50	958.806	959.435	91.413	23.6	46	2915	2186.49
7	09/09/2002	16:30	1038.250	50:00	957.440	961.160	91.397	22.6	44	2880	2160.29
8	11/09/2002	15:30	1036.040	47:00	N/A	959.630	91.402	23.7	46	2933	2199.59

Table 2: Water Vapour Transmission through material in 4-A

Sr. No.	Weight change in cups		Time		Weight change per unit time		q/A		Permeance		Resistance				
	Water Cup	Dry Cup	Specimen Cup	Days	Hours	Seconds	dW/dt	dDes/dt	dSp/dt	Solution Side	Desiccant Side	Solution Side	Desiccant Side		
1	0.000	0.000	0.000	0	0:00	0	-0.0000128	0.0000118	0.0000000	-0.0000010	0.0000009	4.4124E-10	4.057E-10	2.266E+09	2.465E+09
2	-2.074	1.907	-0.001	2	45:00	162000	-0.0000128	0.0000122	0.0000000	-0.0000010	0.0000009	4.4666E-10	4.264E-10	2.239E+09	2.345E+09
3	-3.424	2.990	0.013	2	46:75	168300	-0.0000120	0.0000104	0.0000000	-0.0000009	0.0000008	4.1233E-10	3.601E-10	2.425E+09	2.777E+09
4	-2.076	2.196	-0.011	2	44:00	158400	-0.0000131	0.0000139	-0.0000001	-0.0000010	0.0000010	4.5443E-10	4.807E-10	2.201E+09	2.08E+09
5	-1.985	1.758	0.015	3	46:50	167400	-0.0000119	0.0000105	0.0000001	-0.0000009	0.0000008	4.0869E-10	3.619E-10	2.447E+09	2.783E+09
6	-2.378	2.354	-0.016	2	50:00	180000	-0.0000132	0.0000131	-0.0000001	-0.0000010	0.0000010	4.6085E-10	4.562E-10	2.17E+09	2.192E+09
7	-2.210	2.190	0.005	2	47:00	169200	-0.0000131	0.0000129	0.0000000	-0.0000010	0.0000010	4.4749E-10	4.434E-10	2.235E+09	2.355E+09
8	Total Average												2.283E+09	2.411E+09	
Steady state average												2.283E+09	2.059E+09		

Material C4
Double cup test method (DC)
Liquid cup: Magnesium nitrate hexahydrate, 52% relative humidity
Temperature control: $\pm 1.5^\circ\text{C}$

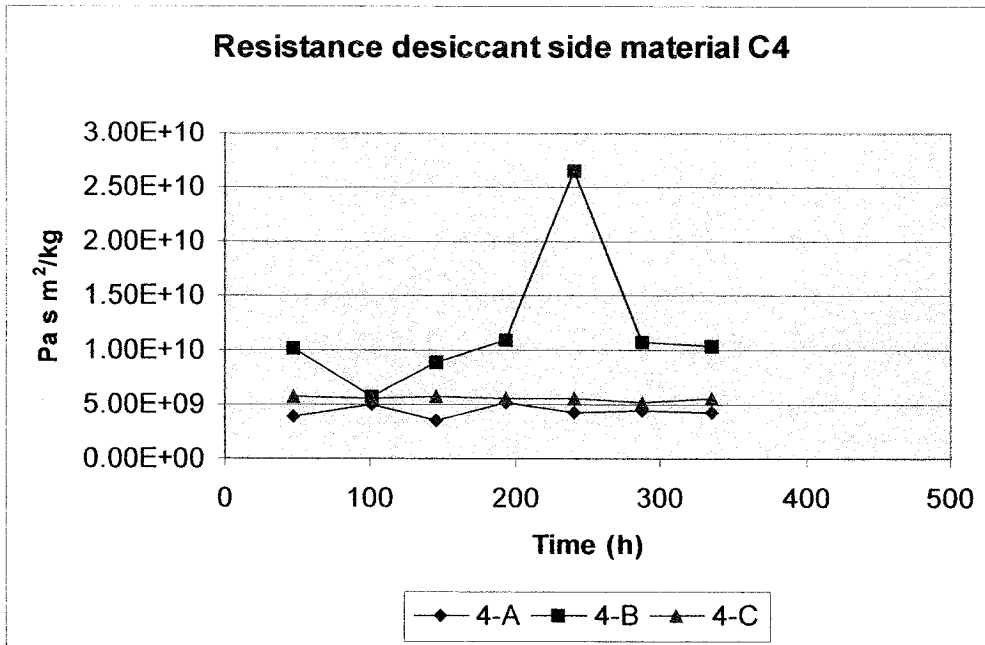
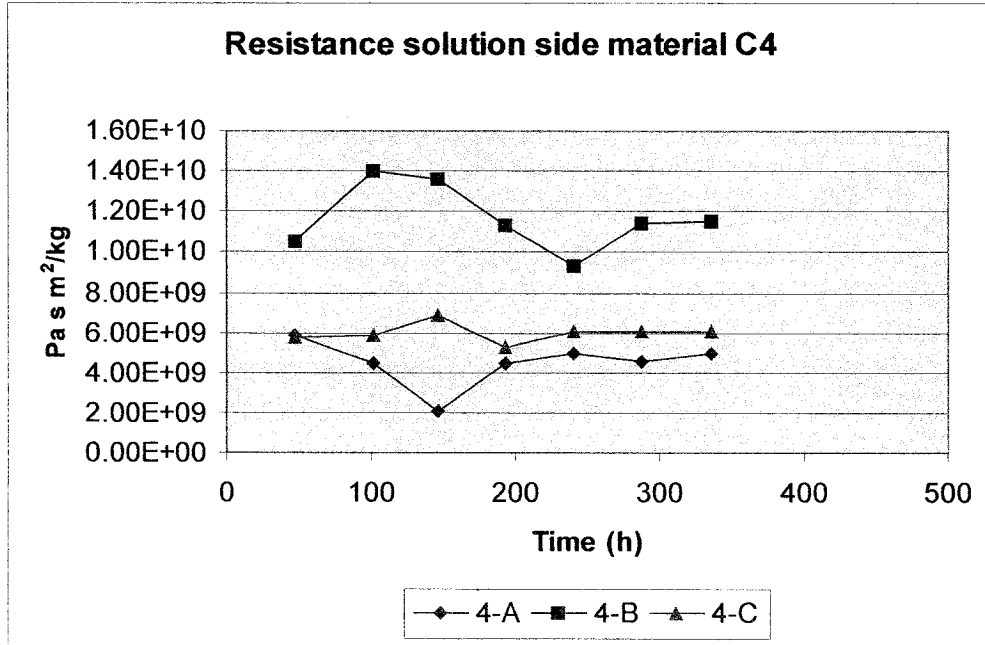

Steady state resistance solution side material C4

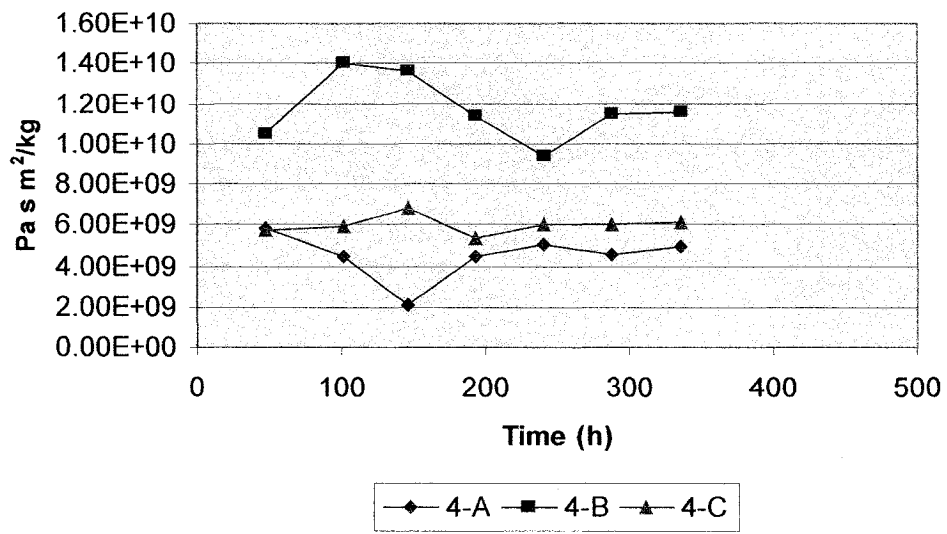

Resistance desiccant side material C4

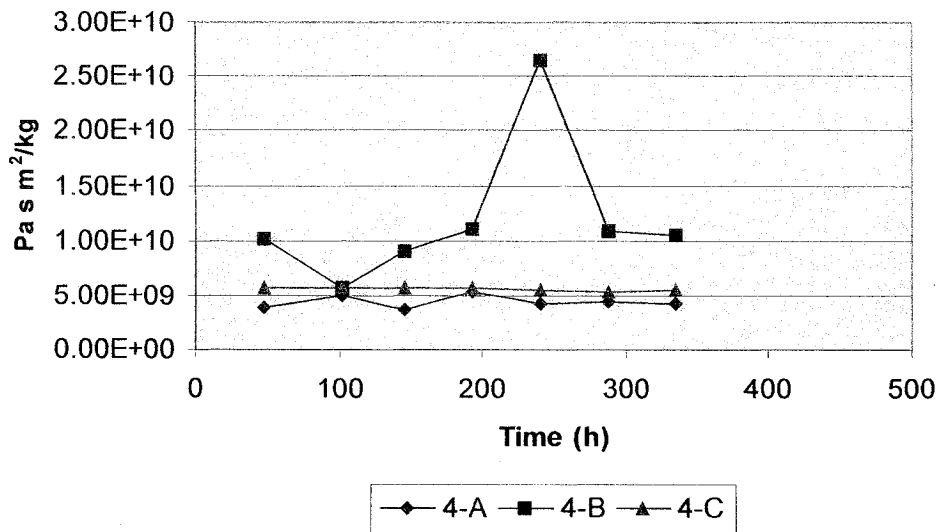

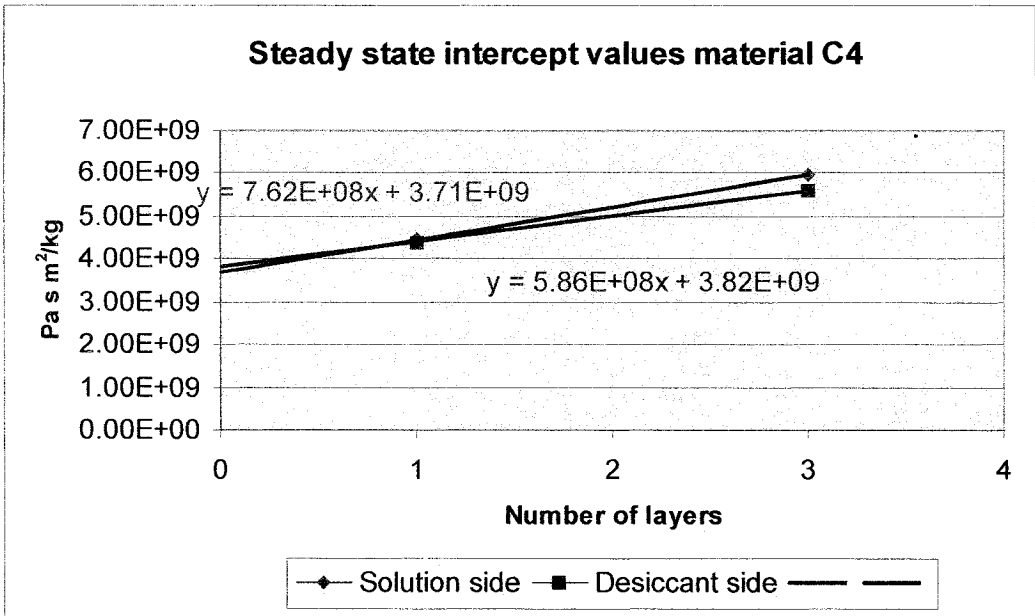
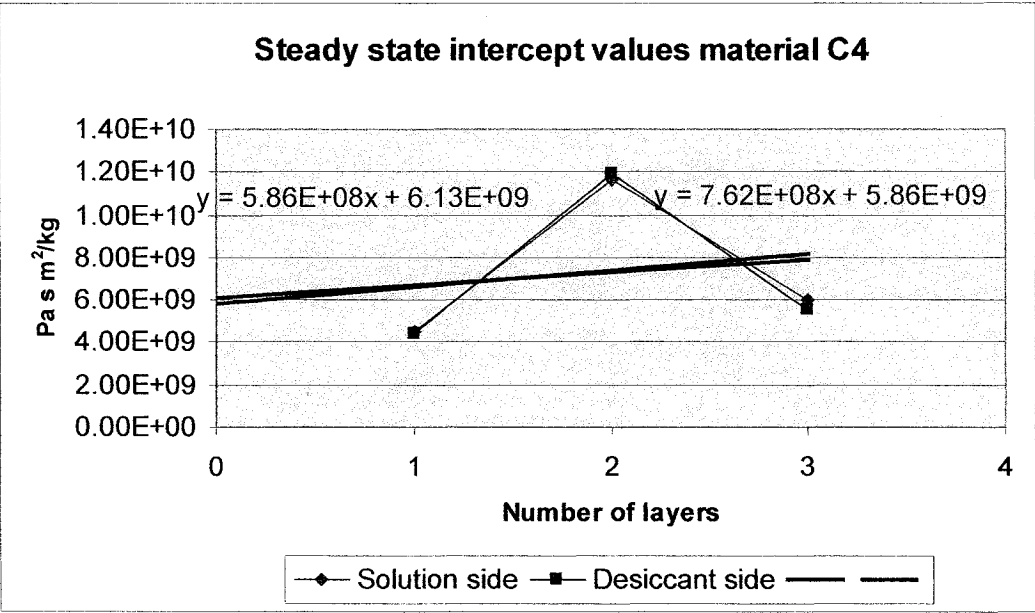

Material C4
 Double cup test method (DC)
 Liquid cup: Magnesium nitrate hexahydrate, 52% Relative Humidity
 August 7th 2002 - Beginning of test
 Temperature control: +/- 1.5 °C

Area of specimen: 0.01327 sq.m.

Thickness of material C4 in mm

Sample Layer 1 Point 1 0.34 Point 2 0.34 Point 3 0.36 Point 4 0.34 Averagethickness 0.345

Weight of paper in grammes
 4-A 5.85

Table 1.: Recordings of weights for 4-A

Sr. No.	Time		Weights (1)				Temp. °C	Relative Humidity %	Pressure difference ΔP	
	Date	Time	Hours	Wt. Of liquid Cup	New wt. Of Dry Cup	Wt. Of Ring + Specimen			Pa at 100%	Pa at 52%
1	07/08/2002	14:25	0:00	1074.760	N/A	88.900	23.1	44	2898	1507
2	09/08/2002	14:00	47:58	1074.180	944.540	951.260	23.4	47	2880	1498
3	11/08/2002	19:50	53:83	1073.290	967.580	945.320	23.8	49	2950	1534
4	13/08/2002	15:00	43:83	1071.640	945.030	968.521	24.7	56	3114	1619
5	15/08/2002	14:50	47:83	1070.780	947.890	945.755	25.8	55	3208	1668
6	17/08/2002	13:50	47:00	1070.050	945.190	948.740	24.8	49	3132	1629
7	16/07/2002	14:20	48:50	1069.245	945.685	946.000	24.2	44	3022	1571
8	19/07/2002	11:50	45:50	1068.580	N/A	946.470	23.6	45	2915	1516

Table 2.: Water Vapour Transmission through material in 4-A

Sr. No.	Weight change in cups		Time			Weight change per unit time			q/A		Permeance		Resistance							
	Water Cup	Dry Cup	Specimen Cup	Days	Hours	Seconds	dW/dt	dDes/dt	dSp/dt	Solution Side	Desiccant Side	Solution Side	Desiccant Side	Solution Side	Desiccant Side					
															(kg/Pa s m ²)		(kg/Pa s m ²)			
1	0.000	0.000	0.000	0	0:00	0	-0.0000034	0.0000051	-0.0000004	-0.0000003	0.0000004	1.7035E-10	2.555E-10	5.87E+09	3.91E+09					
2	-0.580	0.870	-0.060	2	47:58	171300	-0.0000046	0.0000040	-0.0000001	-0.0000003	0.0000003	2.2558E-10	1.977E-10	4.43E+09	5.06E+09					
3	-0.890	0.780	-0.020	2	53:83	193800	-0.0000105	0.0000060	0.0000001	-0.0000008	0.0000004	4.866E-10	2.775E-10	2.06E+09	3.60E+09					
4	-1.650	0.941	0.010	2	43:83	157800	-0.0000050	0.0000042	-0.0000002	-0.0000004	0.0000003	2.256E-10	1.902E-10	4.43E+09	5.26E+09					
5	-0.860	0.725	-0.035	2	47:83	172200	-0.0000043	0.0000050	0.0000001	-0.0000003	0.0000004	1.996E-10	2.324E-10	5.01E+09	4.30E+09					
6	-0.730	0.850	0.020	2	47:00	169200	-0.0000046	0.0000046	0.0000000	-0.0000003	0.0000003	2.211E-10	2.225E-10	4.52E+09	4.50E+09					
7	-0.805	0.810	0.000	2	48:50	174600	-0.0000041	0.0000048	-0.0000001	-0.0000003	0.0000004	2.0181E-10	2.382E-10	4.96E+09	4.20E+09					
8	-0.665	0.785	-0.015	2	45:50	163800	-0.0000041	0.0000048	-0.0000001	-0.0000003	0.0000004	Total Average	4.47E+09	4.40E+09						
															Steady state average		4.468E+09		4.404E+09	

Material C4
 Double cup test method (DC)
 Liquid cup: Magnesium nitrate hexahydrate, 52% Relative Humidity
 October 18th 2002 - Beginning of test
 Temperature control: +/- 1.5 °C

Area of specimen: 0.01327 sq.m.

Thickness of material C4 in mm

Sample	Layer	Point 1	Point 2	Point 3	Point 4	Average thickness
4-B	1	0.34	0.31	0.32	0.34	0.3275
	2	0.34	0.34	0.33	0.31	0.33
Total avg thickness						0.32875

Weight of paper in grammes
 4-B 11.731

Table 1.: Recordings of weights for 4-B

Sr. No.	Date	Time		Weights (1)			Temp. °C	Relative Humidity %	Pressure difference Δ P	
		Time	Hours	Wt. Of liquid Cup	New wt. Of Dry Cup	Wt. Of Ring + Specimen			Pa at 100%	Pa at 52%
1	18/10/2002	15:40	0.00	1059.066	n/a	942.808	25	20	3169	1648
2	20/10/2002	18:20	50.67	1058.663	942.569	943.227	26	23	3363	1749
3	22/10/2002	16:45	46.42	1058.386	945.794	943.242	26	22	3363	1749
4	24/10/2002	16:45	48.00	1058.109	943.630	946.217	25	21	3169	1648
5	26/10/2002	16:15	47.50	1057.780	945.452	943.970	25	29	3169	1648
6	28/10/2002	16:15	48.00	1057.367	942.874	945.598	25	23	3169	1648
7	30/10/2002	16:45	48.50	1057.033	943.321	943.227	25	18	3169	1648
8	01/11/2002	17:15	48.50	1056.705	0.000	943.685	24	22	3151	1638

Daylight savings time: one hour added

Table 2.: Water Vapour Transmission through material in 4-B

Sr. No.	Weight change in cups		Time		Weight change per unit time		q/A		Permeance		Resistance		
	Water Cup	Dry Cup	Days	Hours	dW/dt	dDes/dt	dSp/dt	Solution Side	Desiccant Side	Solution Side	Desiccant Side		
1	0.000	0.000	0	0.00	-0.0000022	0.0000023	-0.0000001	-0.0000002	0.0000002	9.5201E-11	9.898E-11	1.05E+10	1.01E+10
2	-0.403	0.419	2	50.67	-0.0000017	0.0000040	0.0000000	-0.0000001	0.0000003	7.1427E-11	1.7354E-10	1.4E+10	5.762E+09
3	-0.277	0.673	2	46.42	-0.0000016	0.0000024	0.0000000	-0.0000001	0.0000002	7.3299E-11	1.1193E-10	1.364E+10	8.934E+09
4	-0.277	0.423	3	48.00	-0.0000019	0.0000020	0.0000000	-0.0000001	0.0000001	8.7976E-11	9.0917E-11	1.137E+10	1.1E+10
5	-0.329	0.340	2	47.50	-0.0000023	0.0000008	0.0000000	-0.0000001	0.0000001	1.0706E-10	3.7846E-11	9.341E+09	2.642E+10
6	-0.413	0.146	3	49.00	-0.0000019	0.0000020	0.0000000	-0.0000001	0.0000002	8.7471E-11	9.2447E-11	1.143E+10	1.082E+10
7	-0.334	0.353	2	48.50	-0.0000019	0.0000021	0.0000000	-0.0000001	0.0000002	8.6402E-11	9.5885E-11	1.157E+10	1.043E+10
8	-0.328	0.364	2	48.50	-0.0000019	0.0000021	0.0000000	-0.0000001	0.0000002	Total Average			1.169E+10
											Steady state average		1.192E+10

Material C4
 Double cup test method (DC)
 Liquid cup: Magnesium nitrate hexahydrate, 52% Relative Humidity
 August 23rd 2002 - Beginning of test
 Temperature control: +/- 1.5 °C

Area of specimen: 0.01327 sq.m.

Thickness of material C4 in mm

Sample	Layer	Point 1	Point 2	Point 3	Point 4	Average thickness
4-C	1	0.34	0.34	0.35	0.33	0.34
	2	0.34	0.35	0.34	0.34	0.34
	3	0.32	0.33	0.34	0.34	0.3325
Total avg thickness						0.3375

Weight of paper in grammes

4-C 16.83

Table 1.: Recordings of weights for 4-C

Sr. No.	Time		Weights (1)				Temp. °C	Relative Humidity %	Pressure difference Δ P		
	Date	Time	Hours	Wt. Of liquid Cup	New wt. Of Dry Cup	Wt. Of Dry Cup			Wt. Of Ring + Specimen	Pa at 100%	Pa at 52%
1	27/08/2002	16:15	47.75	1068.091	n/a	943.830	108.750	2950	1534		
2	29/08/2002	13:15	45.00	1067.526	943.996	944.399	108.741	2915	1516		
3	31/09/2002	12:00	46.75	1066.960	940.723	944.590	108.739	2880	1498		
4	03/09/2002	19:30	79.50	1066.119	932.410	941.742	108.740	2915	1516		
5	05/09/2002	15:30	44.00	1065.520	943.905	932.972	108.738	2898	1507		
6	07/09/2002	14:00	46.50	1064.961	945.350	944.508	108.740	2915	1516		
7	09/09/2002	16:00	50.00	1064.366	943.794	946.028	108.731	2880	1498		
8	11/09/2002	15:00	47.00	1063.804	947.156	944.403	108.729	2933	1525		

Table 2.: Water Vapour Transmission through material in 4-C

Sr. No.	Weight change in cups		Time			Weight change per unit time			q/A		Permeance		Resistance	
	Water Cup	Dry Cup	Specimen Cup	Days	Hours	Seconds	dW/dt	dDes/dt (g/s)	dSp/dt	Solution Side (kg/s m²)	Desiccant Side (kg/s m²)	Solution Side (kg/Pa s m²)	Desiccant Side (kg/Pa s m²)	
														Pa
1	0.000	0.000	0.000	0	0.00	0	-0.0000035	-0.0000001	-0.0000003	0.0000003	1.7337E-10	1.746E-10	5.768E+09	5.727E+09
2	-0.565	0.569	-0.009	2	45.00	162000	0.0000035	0.0000000	0.0000000	0.0000003	1.692E-10	1.7757E-10	5.91E+09	5.631E+09
3	-0.566	0.594	-0.002	2	46.75	168300	0.0000034	0.0000000	0.0000000	0.0000003	1.4607E-10	1.7699E-10	6.846E+09	5.65E+09
4	-0.841	1.019	0.001	3	79.50	286200	-0.0000029	0.0000036	0.0000000	0.0000003	1.8911E-10	1.7743E-10	5.288E+09	5.636E+09
5	-0.599	0.562	-0.002	2	44.00	158400	0.0000038	0.0000000	0.0000000	0.0000003	1.86E-10	1.7906E-10	6.024E+09	5.585E+09
6	-0.559	0.603	0.002	3	46.50	167400	0.0000033	0.0000038	0.0000000	0.0000003	1.6631E-10	1.8951E-10	6.013E+09	5.277E+09
7	-0.595	0.678	-0.009	2	50.00	180000	0.0000033	0.0000038	-0.0000001	0.0000003	1.6413E-10	1.8077E-10	6.093E+09	5.532E+09
8	-0.562	0.619	-0.002	2	47.00	169200	0.0000037	0.0000000	0.0000000	0.0000003	Total Average	5.992E+09	5.577E+09	
Steady state average											5.992E+09	5.577E+09		

Material C5
Double cup test method (DC)
Liquid cup: Water, 100% relative humidity
Temperature control: $\pm 1.0^{\circ}\text{C}$

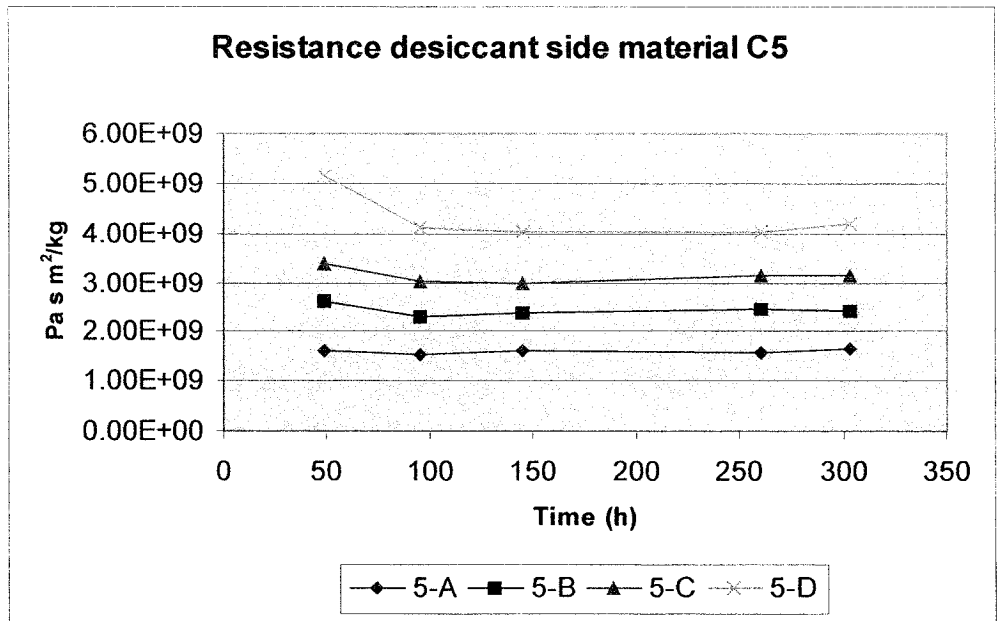
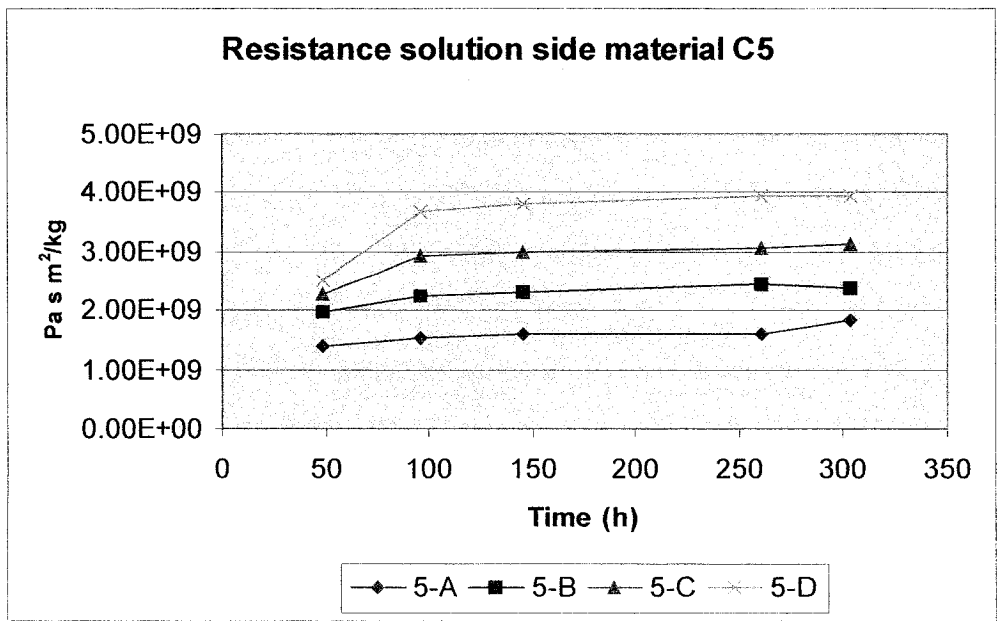

Steady state resistance solution side material C5

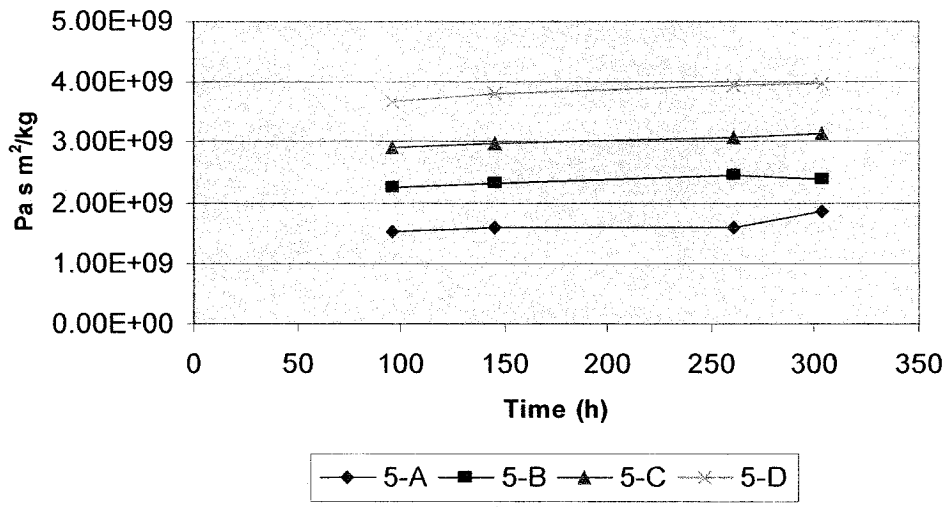

Steady state resistance desiccant side material C5

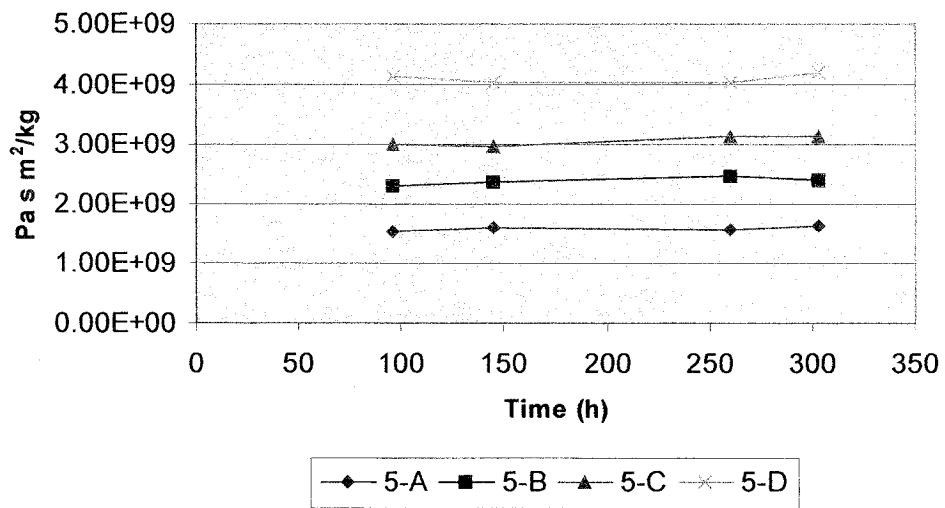

Steady state intercept values material C5

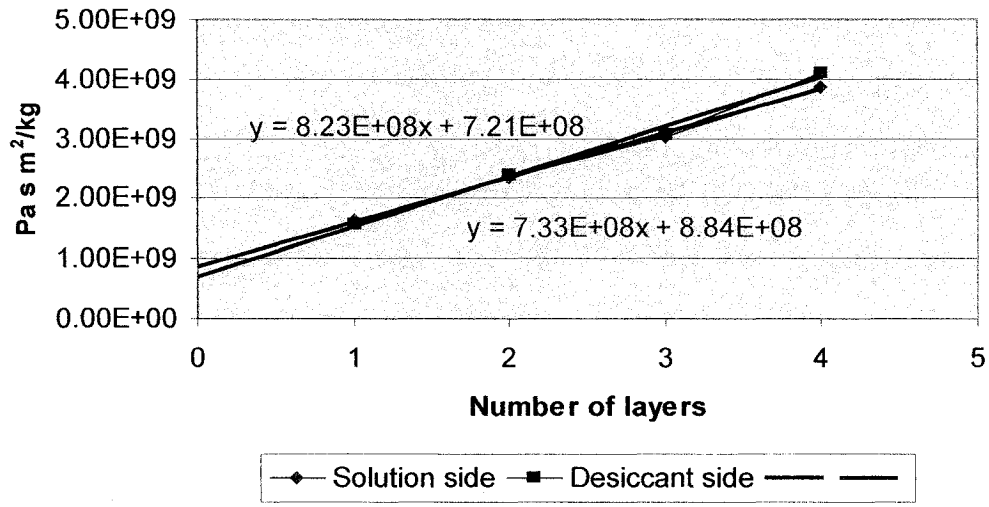

Material C5
 Double cup test method (DC)
 Liquid cup: Water, 100% R.H.
 December 6th 2001 - Beginning of test
 Temperature control: +/- 1.0 °C

Area of specimen: 0.01327 sq.m.

Thickness of material C5 in mm
 Sample Layer Point 1 Point 2 Point 3 Point 4 Average thickness
 5-A 1 0.64 0.7 0.7 0.68 0.680

Weight of paper in grammes
 5-A 10.385

Table 1.: Recordings of weights for 5-A

Sr. No.	Date	Time Time	Hours	Weights (1)			Temp. °C	Relative Humidity %	Pressure difference Δ P
				Wt. Of liquid Cup	New wt. Of Dry Cup	Wt. Of Ring + Specimen			
1	06/12/2001	18:05	0:00	1179.435	N/A	94.627	26	48	3353
2	08/12/2001	18:45	48:67	1174.165	944.931	94.886	25	38	3169
3	10/12/2001	17:40	46:92	1169.473	944.765	94.888	25	42	3169
4	12/12/2001	19:10	49:50	1164.742	944.775	94.908	25	42	3169
5	17/12/2001	14:25	115:25	1153.850	944.622	95.995	25	41	3169
6	19/12/2001	9:15	42:83	1150.120	944.791	94.888	26	43	3353

Table 2.: Water Vapour Transmission through material in 5-A

Sr. No.	Weight change in cups			Time			Weight change per unit time			q/A		Permeance		Resistance			
	Water Cup	Dry Cup	Specimen Cup	Days	Hours	Seconds	dW/dt	dDes/dt	dSp/dt	Solution Side	Desiccant Side	Solution Side	Desiccant Side	Solution Side	Desiccant Side		
1	0.000	0.000	0.000	0	0:00	0	-0.00000301	0.0000261	0.0000015	-0.0000023	0.0000020	7.152E-10	6.204E-10	1.40E+09	1.61E+09		
2	-5.270	4.571	0.259	2	48:67	175200	-0.0000278	0.0000276	0.0000000	-0.0000021	0.0000021	6.805E-10	6.562E-10	1.51E+09	1.52E+09		
3	-4.692	4.661	0.002	2	46:92	168900	-0.0000265	0.0000262	0.0000001	-0.0000020	0.0000020	6.313E-10	6.238E-10	1.58E+09	1.60E+09		
4	-4.731	4.675	0.020	2	49:50	178200	-0.0000263	0.0000270	0.0000001	-0.0000020	0.0000020	6.242E-10	6.43E-10	1.80E+09	1.66E+09		
5	-10.892	11.220	0.056	2	115:25	414900	-0.0000242	0.0000273	-0.0000005	-0.0000018	0.0000021	5.42E-10	6.126E-10	1.85E+09	1.63E+09		
6	-3.730	4.216	-0.076	2	42:83	154200	-0.0000242	0.0000273	-0.0000005	-0.0000018	0.0000021	5.42E-10	6.126E-10	1.85E+09	1.63E+09		
Total average										1.589E+09		1.585E+09		1.589E+09		1.579E+09	
Steady state average										1.636E+09		1.636E+09		1.636E+09		1.636E+09	

Material C5
 Double cup test method (DC)
 Liquid cup: Water, 100% R.H.
 December 6th 2001 - Beginning of test
 Temperature control: +- 1.0 °C

Area of specimen: 0.01327 sq.m.

Thickness of material C5 in mm
 Sample Layer Point 1 Point 2 Point 3 Point 4 Average thickness
 5-B 1 0.7 0.68 0.68 0.69 0.6875
 2 0.67 0.69 0.69 0.69 0.685
 Total avrg 0.343

Weight of paper in grammes
 5-B 20.765

Table 1: Recordings of weights for 5-B

Sr. No.	Time		Weights (1)				Temp. °C	Relative Humidity %	Pressure difference Δ P
	Date	Hours	Wt. Of liquid Cup	New wt. Of Dry Cup	Wt. Of Dry Cup	Wt. Of Ring + Specimen			
1	06/12/2001	18:10	0.00	N/A	955.785	107.652	26	48	3363
2	08/12/2001	18:55	48.75	956.066	958.625	108.094	25	38	3169
3	10/12/2001	17:50	46.92	956.037	959.175	108.076	25	42	3169
4	12/12/2001	19:15	49.42	956.521	959.188	108.103	25	42	3169
5	17/12/2001	14:30	115.25	955.981	963.592	108.184	25	41	3169
6	19/12/2001	9:20	42.83	956.013	958.851	108.092	26	43	3363

Table 2: Water Vapour Transmission through material in 5-B

Sr. No.	Weight change in cups			Time			Weight change per unit time			q/A		Permeance		Resistance			
	Water Cup	Dry Cup	Specimen Cup	Days	Hours	Seconds	dW/dt	dDes/dt (g/s)	dSp/dt	Solution Side	Desiccant Side	Solution Side	Desiccant Side	Solution Side	Desiccant Side		
1	0.000	0.000	0.000	0	0.00	0	-0.0000212	0.0000162	0.0000025	-0.0000016	0.0000012	5.0319E-10	3.848E-10	1.987E+09	2.599E+09		
2	-3.714	2.840	0.442	2	48.75	175500	-0.0000184	0.0000184	-0.0000001	-0.0000014	0.0000014	4.457E-10	4.377E-10	2.244E+09	2.285E+09		
3	-3.166	3.109	-0.018	2	46.92	168900	-0.0000181	0.0000177	0.0000002	-0.0000014	0.0000013	4.2984E-10	4.212E-10	2.326E+09	2.374E+09		
4	-3.216	3.151	0.027	2	49.42	177900	-0.0000172	0.0000170	0.0000002	-0.0000013	0.0000013	4.0999E-10	4.052E-10	2.439E+09	2.466E+09		
5	-7.154	7.071	0.081	2	115.25	414900	-0.0000186	0.0000186	-0.0000006	-0.0000014	0.0000014	4.1935E-10	4.17E-10	2.385E+09	2.398E+09		
6	-2.886	2.870	-0.092	2	42.83	154200	-0.0000187	0.0000186	-0.0000006	-0.0000014	0.0000014	Total average	2.276E+09	2.425E+09	Steady state average	2.348E+09	2.381E+09

Material C5
 Double cup test method (DC)
 Liquid cup: Water, 100% R.H.
 December 6th 2001 - Beginning of test
 Temperature control: ± 1.0 °C

Area of specimen: 0.01327 sq.m.

Thickness of material C5 in mm

Sample Layer	Point 1	Point 2	Point 3	Point 4	Average thickness
1	0.69	0.69	0.69	0.69	0.69
2	0.7	0.68	0.7	0.68	0.69
3	0.71	0.7	0.68	0.69	0.695
Total Avrg.					0.519

Weight of paper in grammes

5-C 30.726

Table 1.: Recordings of weights for 5-C

Sr. No.	Time		Hours	Weights (1)		Temp. °C	Relative Humidity %	Pressure difference ΔP
	Date	Time		Wt. Of liquid Cup	New wt. Of Dry Cup			
1	06/12/2001	18:15	0.00	1184.420	954.533	26	48	3363
2	08/12/2001	19:00	48.75	1181.164	956.716	25	38	3169
3	10/12/2001	18:00	47.00	1178.720	954.531	25	42	3169
4	12/12/2001	19:20	49.33	1176.215	957.038	25	42	3169
5	17/12/2001	14:35	115.25	1170.529	954.040	25	41	3169
6	19/12/2001	9:25	42.83	1188.339	954.152	26	43	3363

Table 2.: Water Vapour Transmission through material in 5-C

Sr. No.	Weight change in cups		Time		Weight change per unit time		q/A		Permeance		Resistance				
	Water Cup	Dry Cup	Specimen Cup	Days	Hours	Seconds	dW/dt	dDes/dt	dSp/dt	Solution Side	Desiccant Side	Solution Side	Desiccant Side		
1	0.000	0.000	0.000	0	0.00	0	-0.0000186	0.0000124	0.0000032	-0.0000014	0.0000009	4.4114E-10	2.958E-10	2.267E+09	3.361E+09
2	-3.256	2.183	0.565	2	48.75	175500	-0.0000144	0.0000140	0.0000002	-0.0000011	0.0000011	3.4345E-10	3.331E-10	2.912E+09	3.003E+09
3	-2.444	2.370	0.032	2	47.00	169200	-0.0000141	0.0000141	0.0000000	-0.0000011	0.0000011	3.3537E-10	3.356E-10	2.982E+09	2.979E+09
4	-2.505	2.507	0.000	2	49.33	177600	-0.0000137	0.0000134	0.0000002	-0.0000010	0.0000010	3.2586E-10	3.197E-10	3.069E+09	3.128E+09
5	-5.686	5.579	0.075	2	115.25	414900	-0.0000142	0.0000143	-0.0000002	-0.0000011	0.0000011	3.1822E-10	3.201E-10	3.143E+09	3.124E+09
6	-2.190	2.203	-0.030	2	42.83	154200	-0.0000142	0.0000143	-0.0000002	-0.0000011	0.0000011	3.1822E-10	3.201E-10	3.143E+09	3.124E+09
Total average													2.874E+09	3.123E+09	
Steady state average													3.026E+09	3.068E+09	

Material C5
 Double cup test method (DC)
 Liquid cup: Water, 100% R.H.
 December 6th 2001 - Beginning of test
 Temperature control: +/- 1.0 °C

Area of specimen: 0.01327 sq.m.

Thickness of material C5 in mm		Point 2		Point 3		Point 4		Average thickness	
Sample	Layer	Point 1	Point 2	Point 3	Point 4	Point 3	Point 4	Point 3	Point 4
5-D	1	0.7	0.67	0.67	0.66	0.67	0.66	0.675	0.675
	2	0.68	0.68	0.68	0.66	0.68	0.68	0.68	0.68
	3	0.67	0.69	0.68	0.68	0.68	0.68	0.68	0.68
	4	0.7	0.71	0.67	0.68	0.67	0.68	0.69	0.69
								Total avrg.	0.680

Weight of paper in grammes
 5-D 41.583

Table 1.: Recordings of weights for 5-D

Sr. No.	Date	Time		Weights (1)		Temp. °C	Relative Humidity %	Pressure difference Δ P
		Time	Hours	Wt. Of liquid Cup	New wt. Of Dry Cup			
1	06/12/2001	18:20	0.00	1182.801	N/A	26	48	3363
2	08/12/2001	19:05	48.75	1179.670	935.351	25	38	3169
3	10/12/2001	18:05	47.00	1177.740	935.645	25	42	3169
4	12/12/2001	19:25	49.33	1175.785	935.518	25	42	3169
5	17/12/2001	14:40	115.33	1171.360	935.544	25	41	3169
6	19/12/2001	9:30	42.83	1169.621	936.192	26	43	3363

Table 2.: Water Vapour Transmission through material in 5-D

Sr. No.	Weight change in cups			Time			Weight change per unit time			q/A		Permeance		Resistance	
	Water Cup	Dry Cup	Specimen Cup	Days	Hours	Seconds	dW/dt	dDes/dt	dSp/dt	Solution Side	Desiccant Side	Solution Side	Desiccant Side	Solution Side	Desiccant Side
1	0.000	0.000	0.000	0	0.00	0	-0.0000167	0.0000082	0.0000053	-0.0000013	0.0000006	3.971E-10	1.944E-10	2.52E+09	5.14E+09
2	-2.931	1.435	0.935	2	48.75	175500	-0.0000114	0.0000102	0.0000006	-0.0000009	0.0000008	2.7122E-10	2.426E-10	3.69E+09	4.12E+09
3	-1.930	1.726	0.097	2	47.00	169200	-0.0000110	0.0000104	0.0000003	-0.0000008	0.0000008	2.6174E-10	2.471E-10	3.92E+09	4.09E+09
4	-1.955	1.846	0.058	2	49.33	177600	-0.0000107	0.0000104	0.0000001	-0.0000008	0.0000008	2.5341E-10	2.484E-10	3.95E+09	4.03E+09
5	-4.425	4.337	0.035	2	115.33	415200	-0.0000113	0.0000106	0.0000001	-0.0000008	0.0000008	2.5268E-10	2.384E-10	3.96E+09	4.19E+09
6	-1.739	1.841	0.011	2	42.83	154200	-0.0000113	0.0000106	0.0000001	-0.0000008	0.0000008	2.5268E-10	2.384E-10	3.96E+09	4.19E+09
										Total average	3.59E+09	4.31E+09	3.85E+09	4.10E+09	
										Steady state average	3.85E+09	4.10E+09	3.85E+09	4.10E+09	

Material C5
Double cup test method (DC)
Liquid cup: Salt concentration of 75% relative humidity
Temperature control: $\pm 2.0^{\circ}\text{C}$

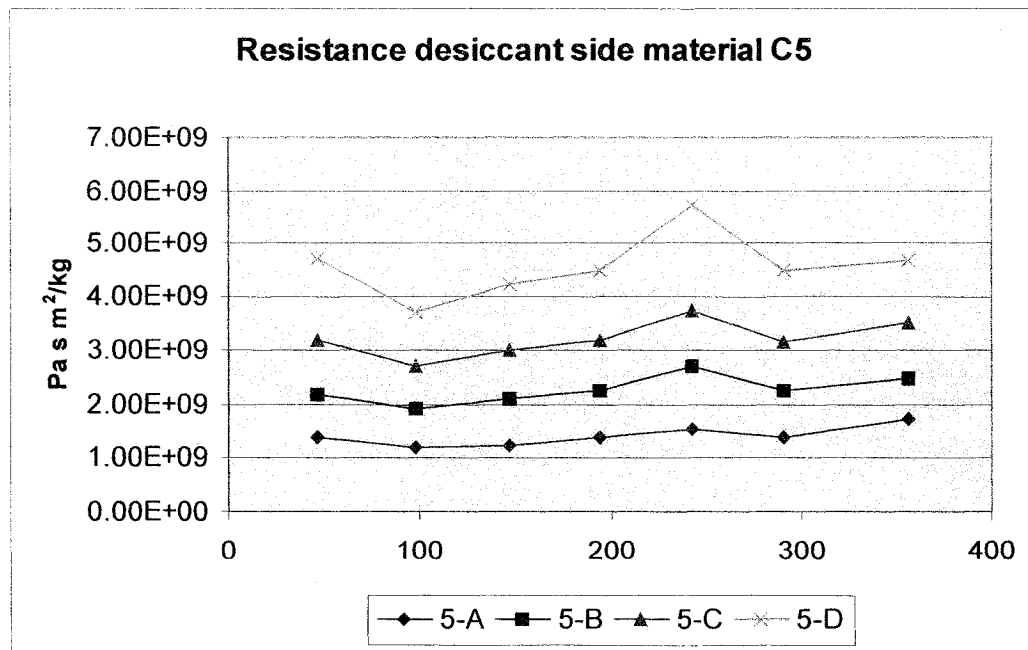
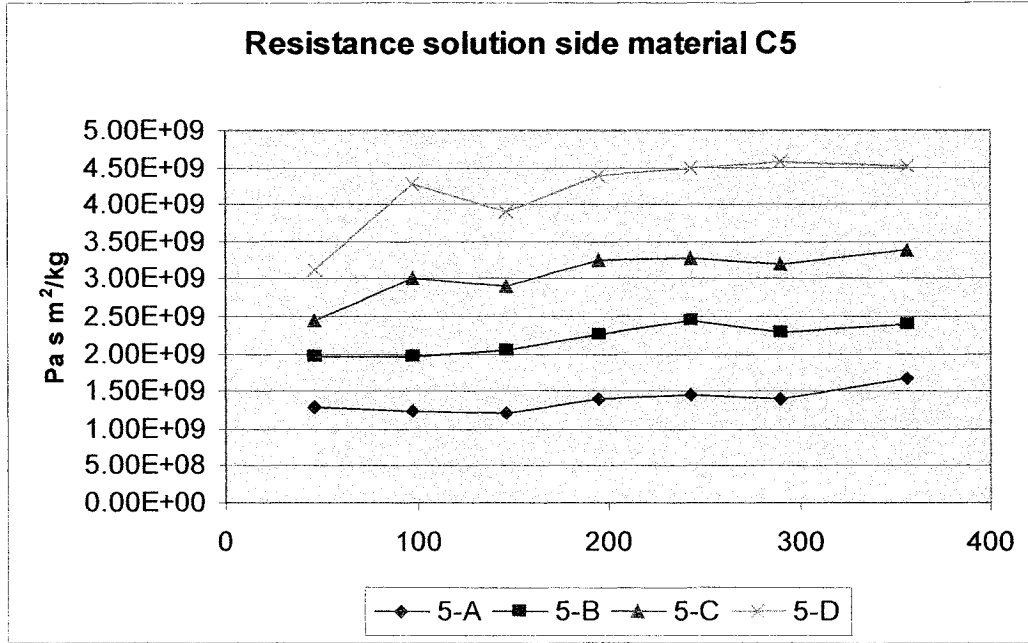

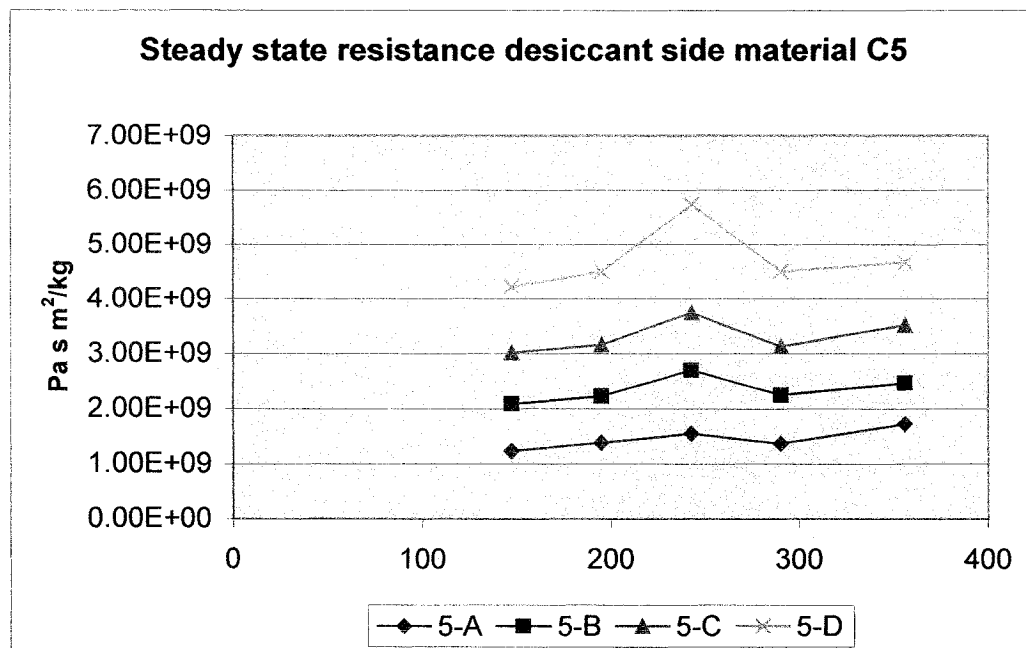
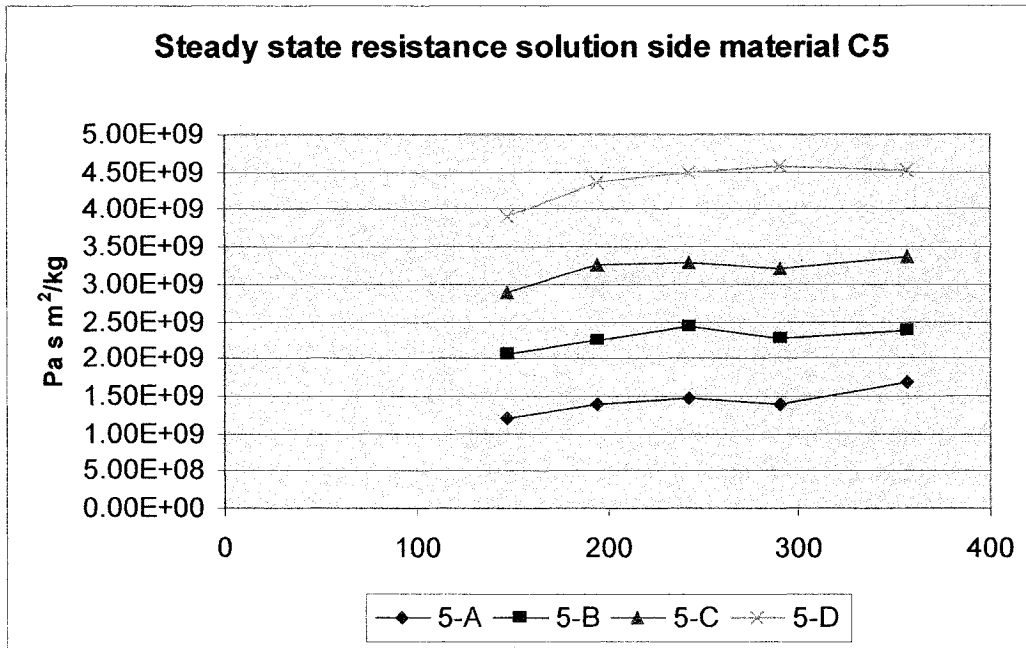

Steady state resistance solution side material C5

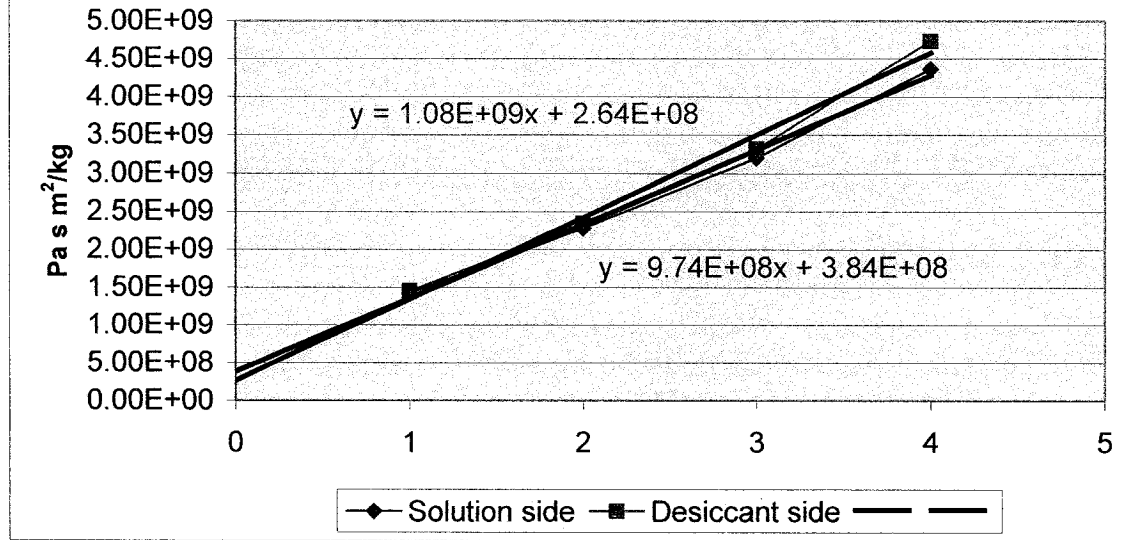

Material C5
 Double cup method (DC)
 Liquid cup: Salt concentration of 75% Relative Humidity
 Jan. 30th 2002 - Beginning of test
 Temperature control: +/- 2.0 °C

Area of specimen: 0.01327 sq.m.

Thickness of material C5 in mm
 Sample Layer Point 1 Point 2 Point 3 Point 4 Averagethickness
 5-A 1 0.62 0.64 0.61 0.62 0.623

Weight of paper in grammes
 5-A 10,058

Table 1.: Recordings of weights for 5-A

Sr. No.	Time		Hours	Weights (1)		Temp. °C	Barometric Pressure Pa	Relative Humidity %	Pressure difference ΔP		
	Date	Time		Wt. Of liquid Cup	New wt. Of Dry Cup				Wt. Of Ring + Specimen	Pa at 100% Pa at 75%	
1	30/01/2002	20:50	0.00	1193.839	N/A	98.129	24.9	1020	43	3151	2363.17
2	01/02/2002	18:40	45.83	1189.880	942.657	938.851	24.8	987	42	3132	2349.36
3	03/02/2002	22:10	51.50	1185.519	970.479	947.179	23.7	999	38	2933	2199.59
4	05/02/2002	23:55	49.75	1181.246	938.412	974.676	23.4	1008	36	2915	2186.49
5	07/02/2002	23:20	47.58	1177.245	940.158	942.412	25.5	998	38	3266	2449.73
6	09/02/2002	23:10	47.83	1172.823	961.468	944.324	26.6	1025	33	3772	2828.63
7	11/02/2002	23:00	47.83	1168.721	961.469	965.613	25.8	1013	34	3325	2493.38
8	14/02/2002	16:20	65.33	1164.079	937.550	965.976	25.8	1010	36	3325	2493.38

Table 2.: Water Vapour Transmission through material in 5-A

Sr. No.	Weight change in cups		Time		Weight change per unit time		q/A		Permeance		Resistance		
	Water Cup	Dry Cup	Specimen	Days	Hours	Seconds	dW/dt	dDes/dt	dSp/dt	Solution Side	Desiccant side	Solution Side	Desiccant side
1	0.000	0.000	0.000	0	0.00	0	-0.0000240	0.0000008	0.0000000	0.0000017	7.6963E-10	1.30E+09	1.40E+09
2	-3.959	3.686	0.133	2	45.83	165000	-0.0000235	0.0000244	-0.0000001	0.0000018	8.0567E-10	1.24E+09	1.20E+09
3	-4.361	4.522	-0.021	2	51.50	185400	-0.0000239	0.0000234	0.0000000	0.0000018	8.2228E-10	1.22E+09	1.24E+09
4	-4.273	4.197	-0.002	2	49.75	179100	-0.0000234	0.0000234	0.0000000	0.0000018	7.1849E-10	1.39E+09	1.39E+09
5	-4.001	4.000	0.003	2	47.58	171300	-0.0000257	0.0000242	-0.0000002	0.0000019	6.8413E-10	1.46E+09	1.55E+09
6	-4.422	4.166	-0.027	2	47.83	172200	-0.0000238	0.0000241	0.0000001	0.0000018	7.1995E-10	1.39E+09	1.37E+09
7	-4.102	4.145	0.018	2	47.83	172200	-0.0000197	0.0000192	0.0000002	0.0000014	5.965E-10	5.792E-10	1.73E+09
8	-4.642	4.507	0.056	2	65.33	235200							
Total average										1.38E+09	1.41E+09		
Steady state average										1.43E+09	1.46E+09		

Material C5
 Double cup method (DC)
 Liquid cup: Salt concentration of 75% Relative Humidity
 Jan. 30th 2002 - Beginning of test
 Temperature control: +/- 2.0 °C

Area of specimen: 0.01327 sq.m.

Thickness of material C5 in mm

Sample Layer	Point 1	Point 2	Point 3	Point 4	Average thickness per layer
1	0.62	0.65	0.61	0.6	0.62
2	0.63	0.62	0.62	0.63	0.625
Average thickness					1.245

Weight of paper in grammes
 5-B 20.282

Table 1.: Recordings of weights for 5-B

Sr. No.	Date	Time	Hours	Weights (1)			Temp. °C	Barometric Pressure Pa	Relative Humidity %	Pressure difference Δ P	
				Wt. Of liquid Cup	New wt. Of Dry Cup	Wt. Of Ring + Specimen				Pa at 100%	Pa at 75%
1	30/01/2002	20:55	0.00	1194.284	N/A	908.931	24.9	1020	43	3151	2363.17
2	01/02/2002	18:55	46.00	1191.653	912.917	911.295	24.8	987	42	3132	2349.36
3	03/02/2002	22:15	51.33	1188.917	910.632	915.748	23.7	999	38	2933	2199.59
4	05/02/2002	0:00	49.75	1186.384	924.290	913.114	23.4	1008	36	2915	2186.49
5	07/02/2002	23:25	47.42	1183.926	907.375	926.775	25.5	998	38	3266	2449.73
6	09/02/2002	23:15	47.83	1181.270	917.755	909.771	26.6	1025	33	3772	2828.63
7	11/02/2002	23:05	47.83	1178.764	942.490	920.290	25.8	1013	34	3325	2493.38
8	14/02/2002	16:25	65.33	1175.512	912.045	945.648	25.8	1010	36	3325	2493.38

Table 2.: Water Vapour Transmission through material in 5-B

Sr. No.	Weight change in cups		Time		Weight change per unit time		g/A		Permeance		Resistance			
	Water Cup	Dry Cup	Days	Hours	Seconds	dDes/dt (g/s)	dW/dt	dSp/dt	Solution Side	Desiccant Side	Solution Side	Desiccant Side		
1	0.000	0.000	0	0.00	0	-0.0000159	0.0000143	0.0000016	-0.0000012	0.0000011	5.0961E-10	4.57896E-10	1.962E+09	2.184E+09
2	-2.631	2.364	2	46.00	165600	0.0000153	0.0000003	0.0000003	-0.0000011	0.0000012	5.0723E-10	5.24837E-10	1.972E+09	1.905E+09
3	-2.736	2.831	2	51.33	184800	-0.0000148	0.0000139	0.0000001	-0.0000011	0.0000010	4.8744E-10	4.77626E-10	2.062E+09	2.094E+09
4	-2.533	2.482	2	49.75	179100	-0.0000141	0.0000144	0.0000000	-0.0000011	0.0000011	4.4296E-10	4.47821E-10	2.258E+09	2.233E+09
5	-2.458	2.485	2	47.42	170700	-0.0000144	0.0000139	-0.0000001	-0.0000012	0.0000010	4.1091E-10	3.70687E-10	2.434E+09	2.688E+09
6	-2.858	2.396	2	47.83	172200	-0.0000154	0.0000147	0.0000001	-0.0000011	0.0000011	4.3983E-10	4.44924E-10	2.274E+09	2.248E+09
7	-2.506	2.535	2	47.83	172200	-0.0000146	0.0000134	0.0000002	-0.0000010	0.0000010	4.1788E-10	4.05804E-10	2.385E+09	2.464E+09
8	-3.252	3.158	3	65.33	235200	-0.0000138	0.0000138	0.0000002	-0.0000010	0.0000010	4.1788E-10	4.05804E-10	2.192E+09	2.261E+09
										Total average		2.282E+09	2.347E+09	
										Steady state average		2.282E+09	2.347E+09	

Material C5
 Double cup method (DC)
 Liquid cup: Salt concentration of 75% Relative Humidity
 Jan. 30th 2002 - Beginning of test
 Temperature control: +/- 2.0 °C

Area of specimen: 0.01327 sq.m.

Thickness of material C5 in mm

Sample Layer	Point 1	Point 2	Point 3	Point 4	Average thickness per layer
1	0.64	0.64	0.62	0.62	0.63
2	0.64	0.64	0.63	0.61	0.63
3	0.62	0.65	0.62	0.63	0.63

Thickness 1.890

Weight of paper in grammes

5-C 30.929

Table 1.: Recordings of weights for 5-C

Sr. No.	Time		Weights (1)				Temp. °C	Barometric Pressure Pa	Relative Humidity %	Pressure difference Δ P	
	Date	Time	Hours	Wt. Of liquid Cup	New wt. Of Dry Cup	Wt. Of Ring + Specimen				Pa at 100%	Pa at 75%
1	30/01/2002	20:45	0.00	1193.949	N/A	907.289	24.9	1020	43	3151	2363.17
2	01/02/2002	19:00	46:25	1191.838	908.312	908.926	24.8	987	42	3132	2349.36
3	03/02/2002	22:20	51:33	1190.041	905.863	910.302	23.7	999	38	2933	2199.59
4	05/02/2002	0:05	49:75	1188.244	907.770	907.588	23.4	1008	36	2915	2186.49
5	07/02/2002	23:30	47:42	1186.539	908.459	909.521	25.5	998	38	3266	2449.73
6	09/02/2002	23:20	47:83	1184.572	907.430	910.186	26.6	1025	33	3772	2828.63
7	11/02/2002	23:10	47:83	1182.793	945.831	909.249	25.8	1013	34	3325	2493.38
8	14/02/2002	16:30	65:33	1180.487	908.006	948.039	25.8	1010	36	3325	2493.38

Table 2.: Water Vapour Transmission through material in 5-C

Sr. No.	Weight change in cups		Time			Weight change per unit time			q/A		Permeance		Resistance		
	Water Cup	Dry Cup	Specimen	Days	Hours	Seconds	dW/dt	dDes/dt	dSp/dt	Solution Side	Desiccant Side	Solution Side	Desiccant Side		
1	0.000	0.000	0.000	0	0.00	0	-0.0000127	0.0000098	0.0000025	-0.0000010	0.0000007	4.0668E-10	3.154E-10	2.46E+09	3.17E+09
2	-2.111	1.837	0.416	2	46:25	166500	-0.0000097	0.000108	-0.0000001	-0.0000007	0.0000008	3.3314E-10	3.689E-10	3E+09	2.71E+09
3	-1.797	1.990	-0.023	2	51:33	184800	-0.0000100	0.0000096	0.0000001	-0.0000008	0.0000007	3.4581E-10	3.32E-10	2.89E+09	3.01E+09
4	-1.797	1.725	0.025	2	49:75	179100	-0.0000100	0.0000103	-0.0000001	-0.0000008	0.0000008	3.0726E-10	3.155E-10	3.25E+09	3.17E+09
5	-1.705	1.751	-0.013	2	47:42	170700	-0.0000114	0.0000100	-0.0000001	-0.0000009	0.0000008	3.0432E-10	2.672E-10	3.25E+09	3.74E+09
6	-1.967	1.727	-0.020	2	47:83	172200	-0.0000103	0.0000106	0.0000000	-0.0000008	0.0000008	3.1224E-10	3.193E-10	3.25E+09	3.13E+09
7	-1.779	1.819	0.000	2	47:83	172200	-0.0000098	0.0000094	0.0000003	-0.0000007	0.0000007	2.9632E-10	2.837E-10	3.37E+09	3.52E+09
8	-2.306	2.208	0.080	3	65:33	235200	-0.0000098	0.0000094	0.0000003	-0.0000007	0.0000007	Total average	3.07E+09	3.21E+09	
											Steady state average		3.2E+09	3.32E+09	

Material C5
 Double cup method (DC)
 Liquid cup: Salt concentration of 75% Relative Humidity
 Jan. 30th 2002 - Beginning of test
 Temperature control: +- 2.0 °C

Area of specimen: 0.01327 sq.m.

Thickness of material C5 in mm

Sample Layer	Point 1	Point 2	Point 3	Point 4	Average thickness per layer
1	0.63	0.62	0.6	0.61	0.615
2	0.63	0.61	0.62	0.63	0.6225
3	0.63	0.62	0.62	0.63	0.63
4	0.61	0.63	0.62	0.62	0.62
Average thickness					0.622

Weight of paper in grammes

5-D 41.537

Table 1.: Recordings of weights for 5-D

Sr. No.	Time		Hours	Weights (1)			Temp. °C	Barometric Pressure Pa	Relative Humidity %		Pressure difference ΔP		
	Date	Time		Wt. Of liquid Cup	New wt. Of Dry Cup	Wt. Of Dry Specimen			Pa at 100%	Pa at 75%	Solution Side	Desiccant side	Solution Side
1	30/01/2002	20:50	0.00	1195.161	N/A	891.581	24.9	1020	43	3151	2363.17		
2	01/02/2002	19:05	46.25	1193.497	896.793	892.680	24.8	987	42	3132	2349.36		
3	03/02/2002	22:25	51.33	1192.233	890.854	898.242	23.7	999	38	2933	2199.59		
4	05/02/2002	0:10	49.75	1190.901	902.381	892.083	23.4	1008	36	2915	2186.49		
5	07/02/2002	23:35	47.42	1189.631	890.658	903.612	25.5	998	38	3266	2449.73		
6	09/02/2002	23:25	47.83	1188.189	898.358	891.783	26.6	1025	33	3772	2828.63		
7	11/02/2002	23:15	47.83	1186.940	890.887	897.623	25.8	1013	34	3325	2493.38		
8	14/02/2002	16:35	65.33	1185.219	905.893	892.551	25.8	1010	36	3325	2493.38		

Table 2.: Water Vapour Transmission through material in 5-D

Sr. No.	Weight change in cups		Specimen	Time			Weight change per unit time		q/A		Permeance		Resistance	
	Water Cup	Dry Cup		Days	Hours	Seconds	dW/dt	dDes/dt	dSp/dt	Solution Side	Desiccant Side	Solution Side	Desiccant Side	Solution Side
1	0.000	0.000	0.000	0.00	0	0.0000100	0.0000066	0.0000035	-0.0000008	0.0000005	3.2057E-10	2.117E-10	3.119E+09	4.723E+09
2	-1.664	1.099	0.578	46.25	166500	-0.0000068	0.0000078	0.0000002	-0.0000005	0.0000005	2.3433E-10	2.686E-10	4.267E+09	3.723E+09
3	-1.264	1.449	0.037	51.33	184800	-0.0000074	0.0000069	0.0000001	-0.0000006	0.0000005	2.5632E-10	2.365E-10	3.961E+09	4.228E+09
4	-1.332	1.229	0.012	49.75	179100	-0.0000074	0.0000072	0.0000001	-0.0000006	0.0000005	2.2887E-10	2.218E-10	4.369E+09	4.508E+09
5	-1.270	1.231	0.009	47.42	170700	-0.0000084	0.0000065	-0.0000001	-0.0000006	0.0000005	2.2309E-10	1.74E-10	4.482E+09	5.745E+09
6	-1.442	1.265	-0.022	47.83	172200	-0.0000073	0.0000073	0.0000000	-0.0000005	0.0000005	2.1922E-10	2.22E-10	4.662E+09	4.504E+09
7	-1.249	1.265	0.008	47.83	172200	-0.0000073	0.0000073	0.0000000	-0.0000005	0.0000005	2.1922E-10	2.22E-10	4.662E+09	4.504E+09
8	-1.721	1.684	0.002	65.33	235200	-0.0000073	0.0000071	0.0000000	-0.0000006	0.0000005	2.2115E-10	2.138E-10	4.175E+09	4.587E+09
Total average											4.175E+09	4.587E+09		
Steady state average											4.367E+09	4.732E+09		

Material C5
Double cup test method (DC)
Liquid cup: Salt concentration of 75% relative humidity
Temperature control: $\pm 1.5^{\circ}\text{C}$

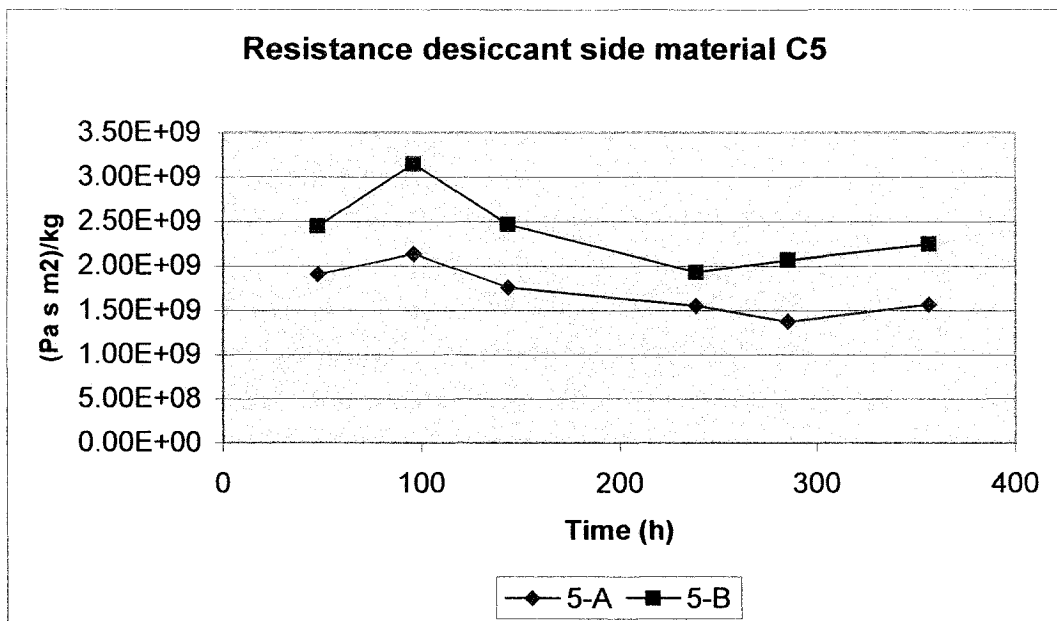
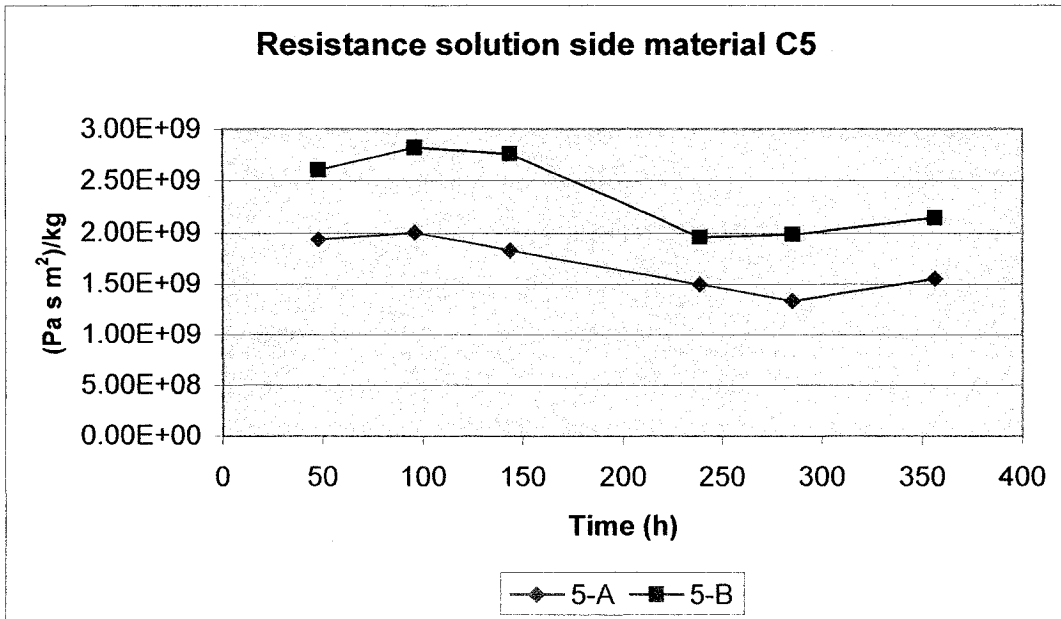

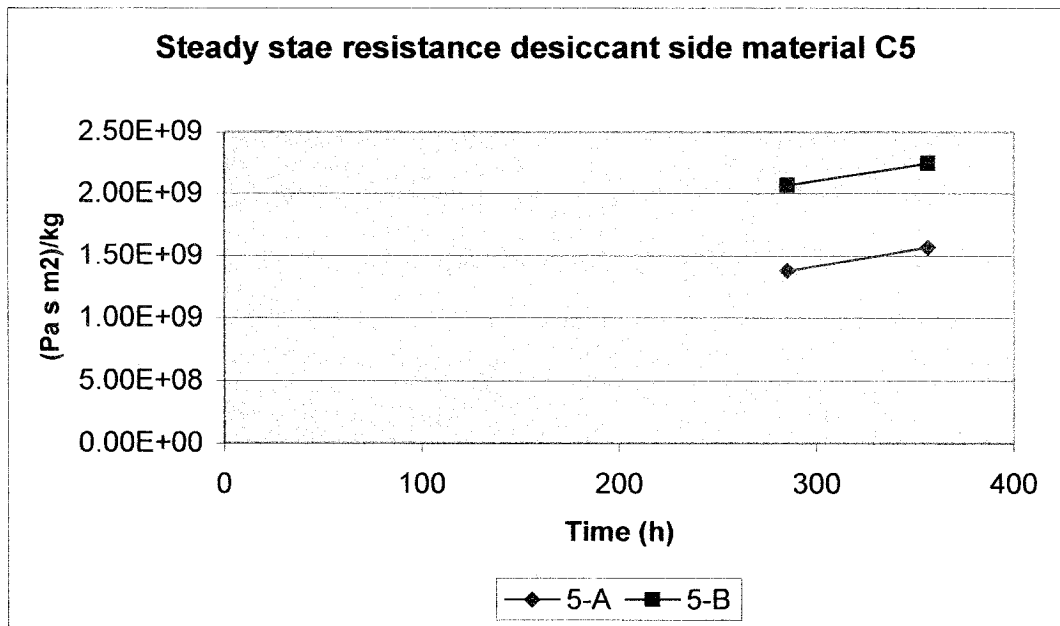
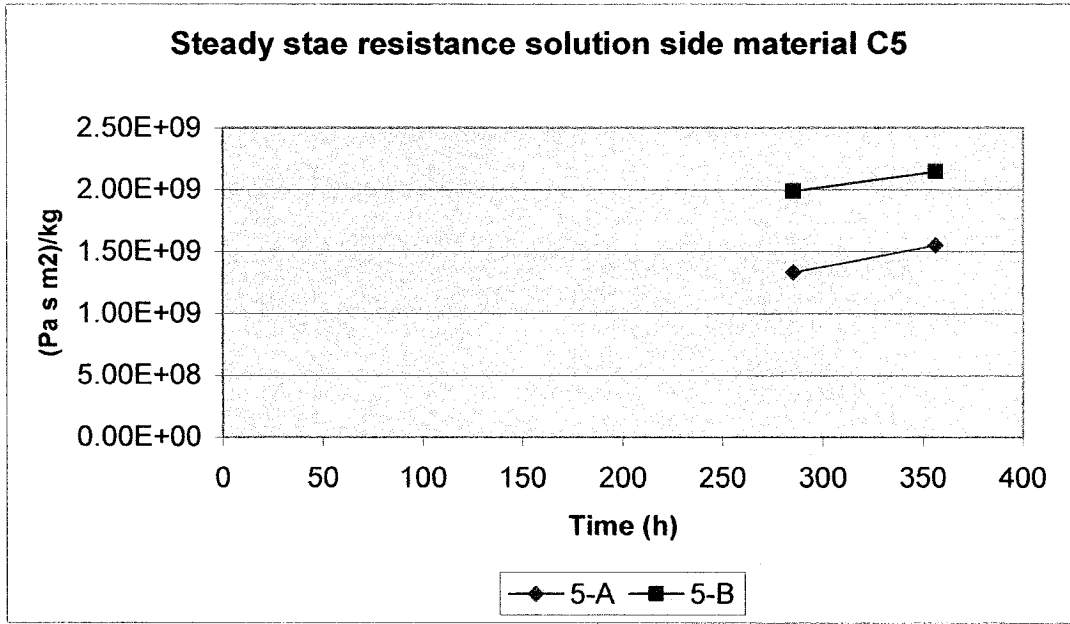

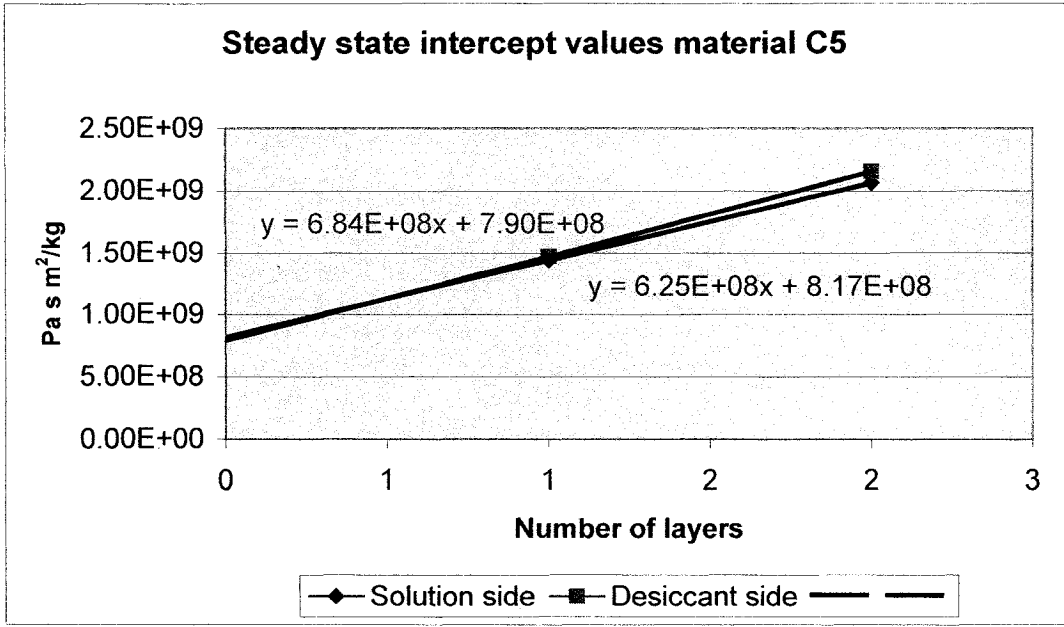

Material C5
 Double cup method (DC)
 July 4th, 2002 - Beginning of test
 Liquid cup: Salt concentration of 75% Relative Humidity
 Temperature control: +/- 1.5 °C

Area of specimen: 0.01327 sq.m.

Thickness of material 5 in mm

Sample Layer Point 1 Point 2 Point 3 Point 4 Average thickness per layer
 5-B 1 0.69 0.66 0.7 0.67 0.68
 2 0.7 0.68 0.69 0.68 0.6875
 Average thickness 1.368

Weight of paper in grammes
 5-B 21.31

Table 1: Recordings of weights for 5-B

Sr. No.	Time		Weights(1)		Temp. °C	Relative Humidity %	Pressure difference ΔP	
	Date	Hours	Wt. Of liquid Cup	New wt. Of Dry Cup			Pa at 100%	Pa at 75%
1	04/07/2002	15:20	0.00	N/A	24.1	49	3004	2252.71
2	06/07/2002	15:20	48.00	959.868	23.9	45	2968	2225.80
3	08/07/2002	15:20	48.00	957.754	23.6	47	2915	2186.49
4	10/07/2002	15:20	48.00	958.403	23.5	46	2898	2173.39
5	12/07/2002	15:20	48.00	957.499	23.1	50	3567	2675.55
6	14/07/2002	14:20	47.00	958.209	26.1	50	3384	2537.78
7	16/07/2002	12:50	46.50	958.212	24.2	49	3022	2266.52
8	19/07/2002	11:50	71.00	N/A	23.8	52	2950	2212.70

Table 2: Water Vapour Transmission through material in 5-B

Sr. No.	Weight change in cups		Time		Weight change per unit time		q/A		Permeance		Resistance	
	Water Cup	Dry Cup	Days	Hours	Seconds	dW/dt	dDes/dt	dSp/dt	Solution Side	Desiccant Side	Solution Side	Desiccant Side
1	0.000	0.000	0	0.00	0	-0.0000113	0.0000121	-0.0000005	3.8402E-10	4.089E-10	2.60E+09	2.45E+09
2	-1.960	2.087	2	48.00	172800	-0.0000103	0.0000092	0.0000001	3.5443E-10	3.175E-10	2.82E+09	3.15E+09
3	-1.777	1.592	2	48.00	172800	-0.0000105	0.0000117	-0.0000003	3.6238E-10	4.049E-10	2.78E+09	2.47E+09
4	-1.806	2.018	2	48.00	172800	-0.0000105	0.0000154	0.0000011	5.4843E-10	4.345E-10	1.82E+09	2.30E+09
5	-3.355	2.665	2	48.00	172800	-0.0000172	0.0000174	-0.0000001	5.1105E-10	5.174E-10	1.96E+09	1.93E+09
6	-2.912	2.948	2	47.00	169200	-0.0000151	0.0000145	-0.0000007	5.031E-10	4.834E-10	1.99E+09	2.07E+09
7	-2.533	2.434	2	46.50	167400	-0.0000137	0.0000131	0.0000000	4.6582E-10	4.452E-10	2.15E+09	2.25E+09
8	-3.496	3.341	3	71.00	255600	-0.0000137	0.0000131	0.0000000	Total Average	2.38E+09	2.38E+09	2.16E+09
										Steady state average	2.07E+09	2.16E+09

Material C5
 Double cup method (DC)
 July 4th 2002 - Beginning of test
 Liquid cup: Salt concentration of 75% Relative Humidity
 Temperature control: +- 1.5 °C

Area of specimen: 0.01327 sq.m.

Thickness of material 5 in mm

Sample Layer Point 1 Point 2 Point 3 Point 4 Averagethickness
 5-A 1 0.71 0.75 0.68 0.7 0.710

Weight of paper in grammes
 5-A 10.69

Table 1.: Recordings of weights for 5-A

Sr. No.	Time		Hours	Weights (1)		Temp. °C	Relative Humidity %	Pressure difference ΔP	
	Date	Time		Wt. Of liquid Cup	New wt. Of Dry Cup			Wt. Of Ring + Specimen	Pa at 100%
1	04/07/2002	15:15	0:00	1179.576	N/A	24.1	49	3004	2252.71
2	06/07/2002	15:15	48:00	1176.940	945.730	23.9	45	2988	2225.80
3	08/07/2002	15:15	48:00	1174.439	943.680	23.6	47	2915	2186.49
4	10/07/2002	15:15	48:00	1171.712	944.250	23.5	46	2898	2173.39
5	12/07/2002	15:15	48:00	1167.027	945.160	26.1	50	3587	2073.55
6	14/07/2002	14:15	47:00	1163.220	944.087	26.1	50	3384	2537.78
7	16/07/2002	12:50	46:50	1159.446	944.298	24.2	49	3022	2266.52
8	19/07/2002	11:50	71:00	1154.605	949.086	23.8	52	2950	2212.70

Table 2.: Water Vapour Transmission through material in 5-A

Sr. No.	Weight change in cups		Time			Weight change per unit time			q/A		Permeance		Resistance		
	Water Cup	Dry Cup	Specimen Cup	Days	Hours	Seconds	dW/dt	dDes/dt (g/s)	dSp/dt	Solution Side	Desiccant Side	Solution Side	Desiccant Side	Solution Side	Desiccant Side
1	0.000	0.000	0.000	0	0:00	0	-0.0000153	0.0000155	-0.0000002	-0.0000011	0.0000012	5.165E-10	5.241E-10	1.94E+09	1.91E+09
2	-2.636	2.675	-0.037	2	48:00	172800	-0.0000145	0.0000136	-0.0000001	-0.0000011	0.0000010	4.988E-10	4.677E-10	2.00E+09	2.14E+09
3	-2.501	2.345	-0.011	2	48:00	172800	-0.0000158	0.0000164	-0.0000003	-0.0000012	0.0000012	5.472E-10	5.690E-10	1.83E+09	1.76E+09
4	-2.727	2.838	-0.047	2	48:00	172800	-0.0000271	0.0000258	-0.0000019	-0.0000020	0.0000019	7.636E-10	7.253E-10	1.31E+09	1.36E+09
5	-4.665	4.420	-0.295	2	47:00	169200	-0.0000225	0.0000217	0.0000001	-0.0000017	0.0000016	6.681E-10	6.435E-10	1.50E+09	1.55E+09
6	-3.907	3.667	0.017	2	46:50	167400	-0.0000225	0.0000218	-0.0000008	-0.0000017	0.0000016	7.496E-10	7.247E-10	1.33E+09	1.38E+09
7	-3.774	3.649	-0.133	2	71:00	255600	-0.0000189	0.0000187	0.0000002	-0.0000014	0.0000014	6.45E-10	6.379E-10	1.56E+09	1.57E+09
8	-4.841	4.788	0.044	2											
Total Average											1.69E+09	1.72E+09			
Steady state average											1.44E+09	1.47E+09			

Material C5

Liquid cup: Magnesium nitrate hexahydrate, 52% relative humidity

Temperature control: $\pm 1.5^{\circ}\text{C}$

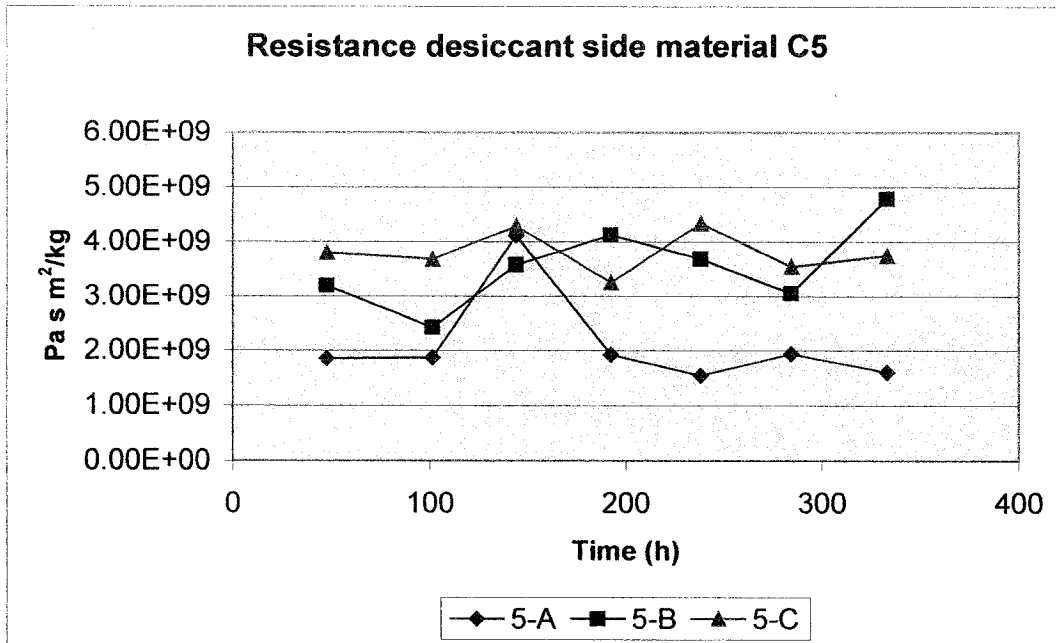
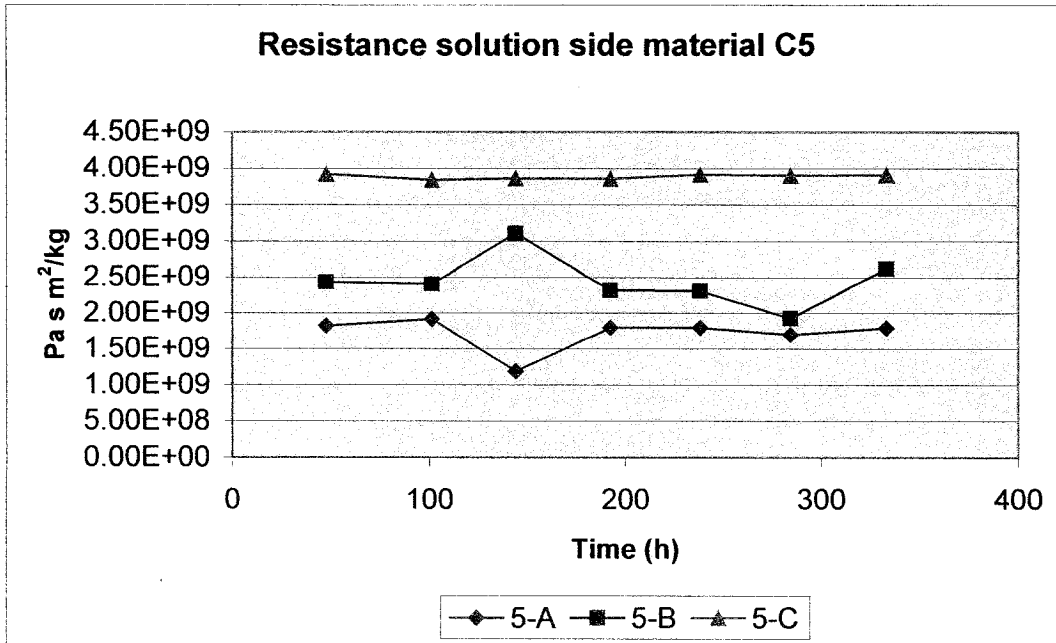

Steady state resistance solution side material C5

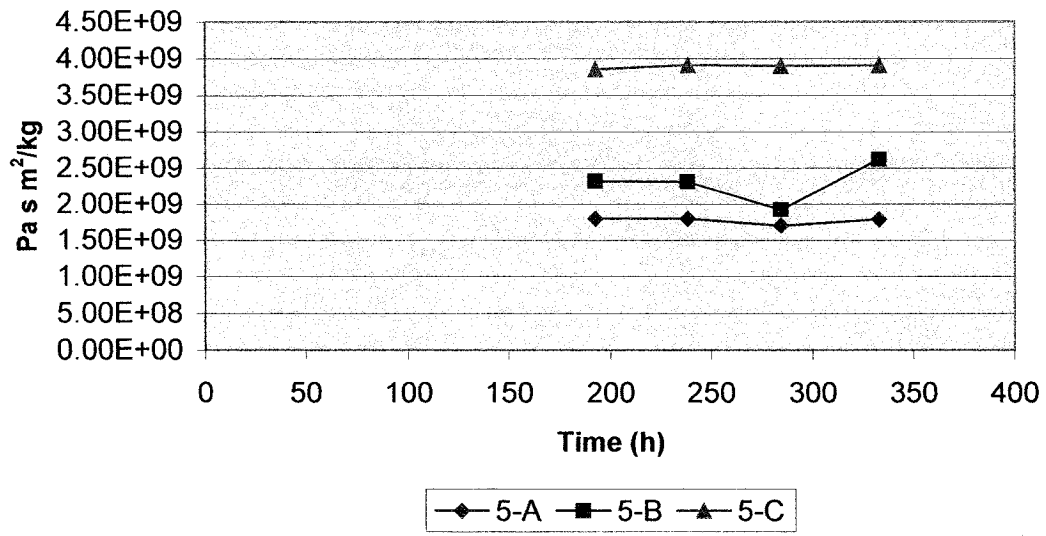

Steady state resistance desiccant side material C5

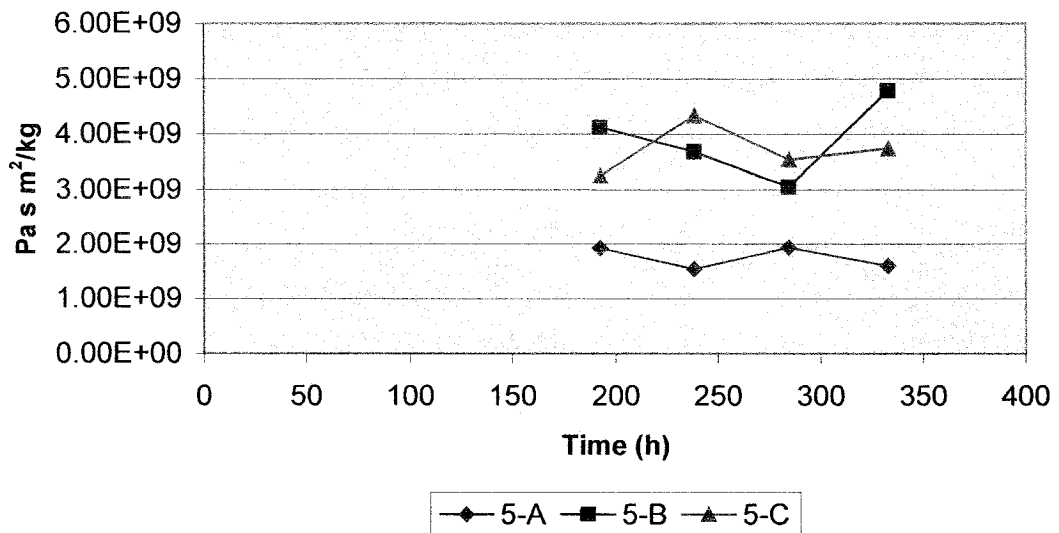

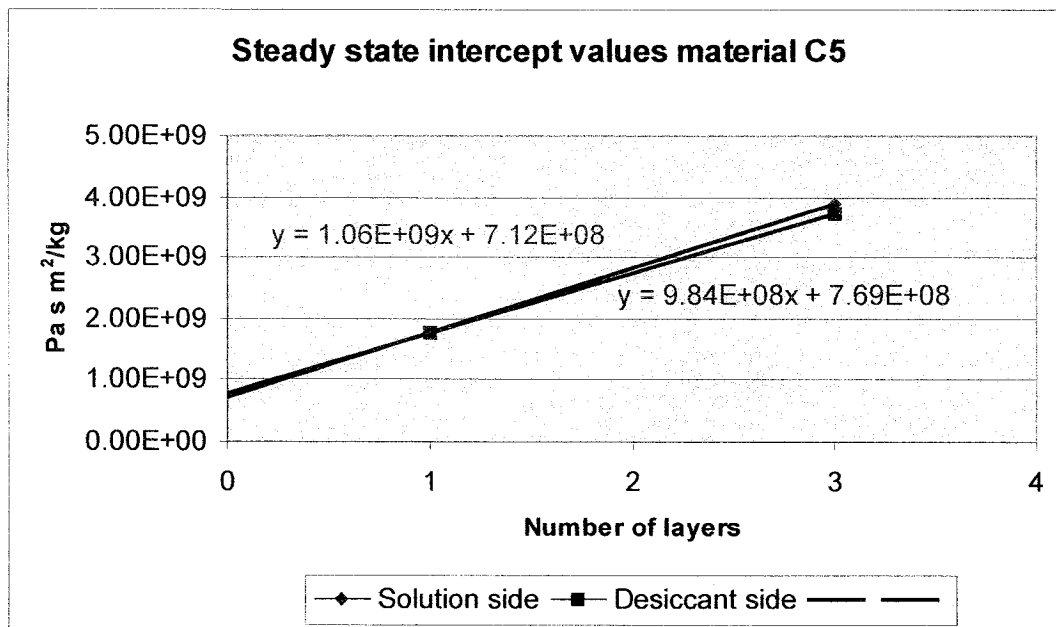
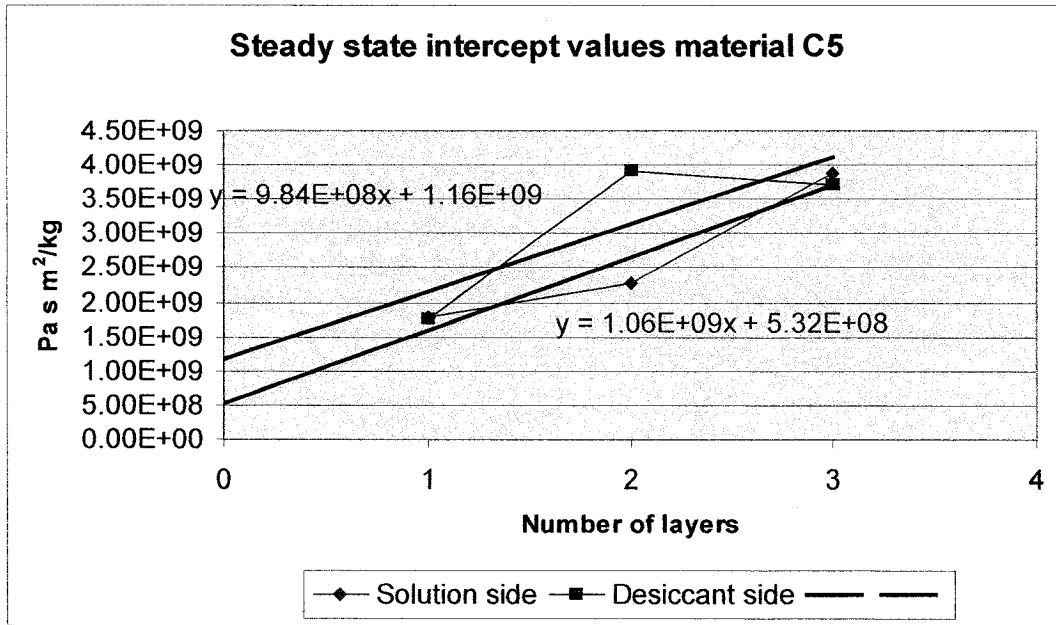

Material C5
 Double cup test method (DC)
 Liquid cup: Magnesium nitrate hexahydrate, 52% Relative Humidity
 August 7th 2002 - Beginning of test
 Temperature control: +- 1.5 °C

Area of specimen: 0.01327 sq.m.

Thickness of material C5 in mm

Sample Layer Point 1 Point 2 Point 3 Point 4 Average thickness
 5-A 1 0.71 0.68 0.68 0.67 0.685

Weight of paper in grammes
 5-A 10.54

Table 1.: Recordings of weights for 5-A

Sr. No.	Date	Time		Hours	Weights (1)		Temp. °C	Relative Humidity %	Pressure difference Δ.P	
		Time	Time		Wt. Of liquid Cup	New wt. Of Dry Cup			Wt. Of Ring + Specimen	Pa at 100%
1	07/08/2002	14:30		0.00		N/A	23.1	44	2898	1507
2	09/08/2002	14:10		47.67	1068.990	944.960	23.4	47	2880	1498
3	11/08/2002	19:50		53.67	1067.120	946.570	23.8	49	2950	1534
4	13/08/2002	14:50		43.00	1065.070	945.610	24.7	56	3114	1619
5	15/08/2002	14:55		48.08	1062.270	947.660	25.8	55	3208	1668
6	17/08/2002	13:55		48.00	1060.140	949.270	24.8	49	3132	1629
7	16/07/2002	14:25		48.50	1058.150	948.320	24.2	44	3022	1571
8	19/07/2002	11:55		45.50	1056.010	946.865	23.6	45	2915	1516

Table 2.: Water Vapour Transmission through material in 5-A

Sr. No.	Weight change in cups			Time			Weight change per unit time			q/A		Permeance		Resistance	
	Water Cup	Dry Cup	Specimen Cup	Days	Hours	Seconds	dW/dt	dDes/dt (g/s)	dSp/dt	Solution Side	Desiccant Side	Solution Side	Desiccant Side	Solution Side	Desiccant Side
1	0.000	0.000	0.000	0	0.00	0	-0.0000109	0.0000107	-0.0000010	0.0000008	0.0000008	5.4828E-10	5.395E-10	1.824E+09	1.854E+09
2	-1.870	1.840	-0.170	2	47.67	171600	-0.0000106	0.0000109	0.0000004	-0.0000008	0.0000008	5.2121E-10	5.339E-10	1.919E+09	1.873E+09
3	-2.050	2.100	0.080	2	53.67	193200	-0.0000181	0.0000052	-0.0000008	0.0000004	0.0000004	8.4175E-10	2.435E-10	1.188E+09	4.107E+09
4	-2.800	0.810	-0.120	2	43.00	154800	-0.0000123	0.0000115	0.0000000	-0.0000009	0.0000009	5.585E-10	5.193E-10	1.789E+09	1.928E+09
5	-2.130	1.990	0.000	2	48.08	173100	-0.0000120	0.0000140	0.0000004	-0.0000009	0.0000011	5.5594E-10	6.481E-10	1.799E+09	5.43E+09
6	-1.990	2.320	0.060	2	46.00	165600	-0.0000123	0.0000107	-0.0000003	-0.0000009	0.0000008	5.8776E-10	5.15E-10	1.701E+09	5.42E+09
7	-2.140	1.875	-0.055	2	48.50	174600	-0.0000112	0.0000125	-0.0000002	-0.0000008	0.0000008	5.584E-10	6.236E-10	1.791E+09	6.03E+09
8	-1.840	2.055	-0.035	3	45.50	163800	-0.0000112	0.0000125	-0.0000002	-0.0000008	0.0000008	5.584E-10	6.236E-10	1.717E+09	2.121E+09
Total Average											1.773E+09	1.763E+09			
Steady state average											1.773E+09	1.763E+09			

Material C5
 Double cup test method (DC)
 Liquid cup: Magnesium nitrate hexahydrate, 52% Relative Humidity
 October 18th 2002 - Beginning of test
 Temperature control: +- 1.6 °C

Area of specimen: 0.01327 sq.m.

Thickness of material C5 in mm

Sample	Layer	Point 1	Point 2	Point 3	Point 4	Average thickness
5-B	1	0.69	0.66	0.68	0.62	0.6625
	2	0.64	0.67	0.65	0.63	0.6475
						Total avg thickness
						0.655

Weight of paper in grammes
 5-B 20.302

Table 1: Recordings of weights for 5-B

Sr. No.	Time		Hours	Weights (1)		Wt. Of Ring + Specimen	Temp. °C	Relative Humidity %	Pressure difference ΔP	
	Date	Time		Wt. Of liquid Cup	New wt. Of Dry Cup				Pa at 100%	Pa at 52%
1	18/10/2002	15:45	0.00	n/a	944.919	113.129	25	20	3169	1648
2	20/10/2002	18:25	50.67	945.305	948.246	113.243	26	23	3363	1749
3	22/10/2002	16:50	46.42	945.080	946.905	113.574	26	22	3363	1749
4	24/10/2002	16:50	48.00	944.528	946.136	113.229	25	21	3169	1648
5	26/10/2002	16:20	47.50	944.884	945.435	113.373	25	29	3169	1648
6	28/10/2002	16:20	49.00	945.631	945.930	113.557	25	23	3169	1648
7	30/10/2002	16:50	48.50	945.291	948.881	113.767	25	18	3169	1648
8	01/11/2002	17:20	48.50	946.084	948.084	113.950	24	22	3151	1638

Daylight savings time, one hour added.

Table 2: Water Vapour Transmission through material in 5-B

Sr. No.	Weight change in cups		Time		Weight change per unit time		q/A		Permeance		Resistance	
	Water Cup	Dry Cup	Days	Hours	dW/dt	dDes/dt	Solution Side	Desiccant Side	Solution Side	Desiccant side	Solution Side	Desiccant side
		Specimen Cup			Seconds	(g/s)	(kg/s m ²)	(kg/s m ²)	(kg/Pa s m ²)	(kg/Pa s m ²)	(kg/Pa s m ²)	(kg/Pa s m ²)
1	0.000	0.000	0	0.00	0	0.0000073	-0.0000007	0.0000005	4.1104E-10	3.135E-10	2.433E+09	3.19E+09
2	-1.740	1.327	2	50.67	182400	0.0000096	-0.0000020	0.0000007	4.1567E-10	4.126E-10	2.406E+09	2.424E+09
3	-1.612	1.600	2	46.42	167100	0.0000070	-0.0000061	0.0000005	3.2177E-10	2.794E-10	3.108E+09	3.579E+09
4	-1.216	1.056	3	48.00	172800	0.0000094	-0.0000053	0.0000004	4.3159E-10	2.425E-10	2.317E+09	4.123E+09
5	-1.614	0.907	2	47.50	171000	0.0000095	-0.0000059	0.0000010	4.3315E-10	2.711E-10	2.309E+09	3.668E+09
6	-1.671	1.046	3	49.00	176400	0.0000114	-0.0000072	0.0000009	5.1985E-10	3.274E-10	1.924E+09	3.065E+09
7	-1.985	1.250	2	48.50	174600	0.0000083	-0.0000045	0.0000006	3.8143E-10	2.089E-10	2.622E+09	4.787E+09
8	-1.448	0.793	2	48.50	174600	0.0000083	-0.0000045	0.0000006	3.8143E-10	2.089E-10	2.622E+09	4.787E+09
										Total Average	2.445E+09	3.913E+09
										Steady state average	2.293E+09	3.913E+09

Material C5

Double cup test method (DC)

Liquid cup: Magnesium nitrate hexahydrate, 52% Relative Humidity

August 23rd 2002 - Beginning of test

Temperature control: +/- 1.5 °C

Area of specimen: 0.01327 sq.m.

Thickness of material C5 in mm

Sample Layer	Point 1	Point 2	Point 3	Point 4	Average thickness
1	0.68	0.68	0.7	0.68	0.685
2	0.69	0.68	0.7	0.68	0.6875
3	0.69	0.66	0.69	0.71	0.6875
Total avg thickness					0.687

Weight of paper in grammes

5-C 31.38

Table 1: Recordings of weights for 5-C

Sr. No.	Time		Weights (1)		Temp. °C	Relative Humidity %	Pressure difference Δ P	
	Date	Time	Wt. Of liquid Cup	New wt. Of Dry Cup			Pa at 100%	Pa at 52%
1	27/08/2002	16:20	47.75	1052.962	24.7	45	2950	1534
2	29/08/2002	13:20	45.00	1052.130	23.6	46	2915	1516
3	31/08/2002	12:05	46.75	1051.258	23.4	43	2880	1498
4	03/09/2002	19:35	79.50	1049.776	23.6	45	2898	1507
5	05/09/2002	15:35	44.00	1048.964	23.5	40	2898	1507
6	07/09/2002	14:05	46.50	1048.093	23.6	46	2915	1516
7	09/09/2002	16:05	50.00	1047.175	22.6	44	2880	1498
8	11/09/2002	15:05	47.00	1046.299	23.7	46	2933	1525

Table 2: Water Vapour Transmission through material in 5-C

Sr. No.	Weight change in cups			Time			Weight change per unit time			q/A		Permeance		Resistance			
	Water Cup	Dry Cup	Specimen Cup	Days	Hours	Seconds	dW/dt	dDes/dt	dSp/dt	Solution Side	Desiccant Side	Solution Side	Desiccant Side	Solution Side	Desiccant Side		
1	0.000	0.000	0.000	0	0.00	0	-0.0000051	0.0000053	0.0000000	-0.0000004	0.0000004	2.553E-10	2.633E-10	3.917E+09	3.798E+09		
2	-0.832	0.858	-0.007	2	45.00	162000	-0.0000052	0.0000054	0.0000000	-0.0000004	0.0000004	2.6068E-10	2.717E-10	3.836E+09	3.68E+09		
3	-0.872	0.909	-0.002	2	46.75	168300	-0.0000052	0.0000052	0.0000001	-0.0000004	0.0000004	2.5896E-10	2.334E-10	3.862E+09	4.284E+09		
4	-1.482	1.336	-0.016	3	79.50	286200	-0.0000052	0.0000061	0.0000000	-0.0000004	0.0000005	2.5952E-10	3.072E-10	3.853E+09	3.255E+09		
5	-0.822	0.973	-0.006	2	44.00	158400	-0.0000051	0.0000046	0.0000001	-0.0000004	0.0000003	2.5667E-10	2.304E-10	3.911E+09	4.324E+09		
6	-0.861	0.776	0.011	2	46.50	167400	-0.0000051	0.0000056	0.0000001	-0.0000004	0.0000004	2.5669E-10	2.82E-10	3.897E+09	3.546E+09		
7	-0.918	1.009	-0.009	2	50.00	180000	-0.0000052	0.0000054	0.0000000	-0.0000004	0.0000004	2.5583E-10	2.669E-10	3.909E+09	3.746E+09		
8	-0.876	0.914	-0.005	3	47.00	169200	-0.0000052	0.0000054	0.0000000	-0.0000004	0.0000004	Total Average		3.84E+09	3.807E+09		
														Steady state average		3.893E+09	3.722E+09

Appendix 1.2: Modified inverted cup test data

Material P6
Modified inverted cup (MIC)
Temperature control: $\pm 1.5^\circ\text{C}$

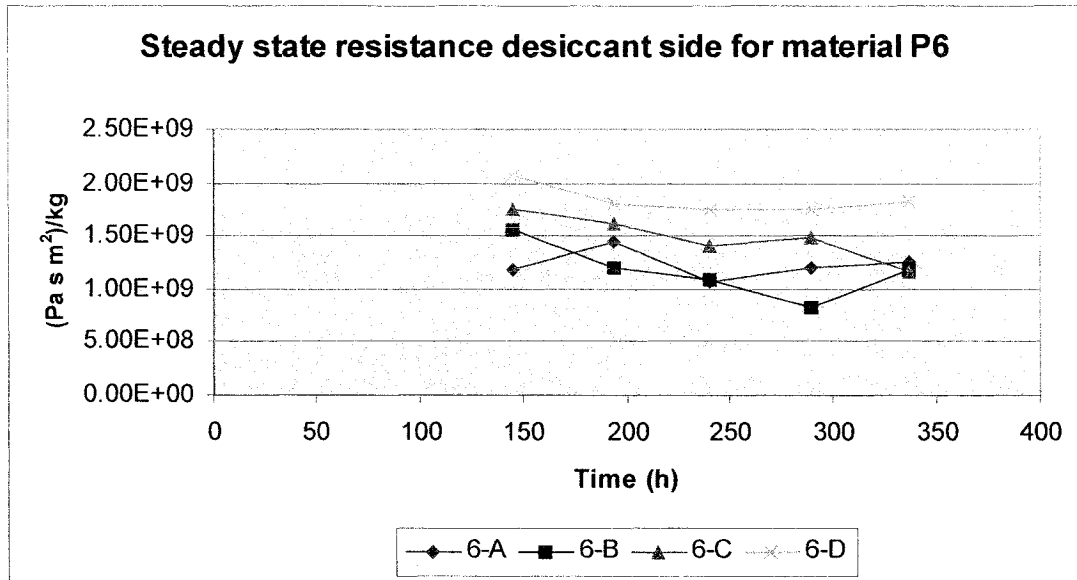
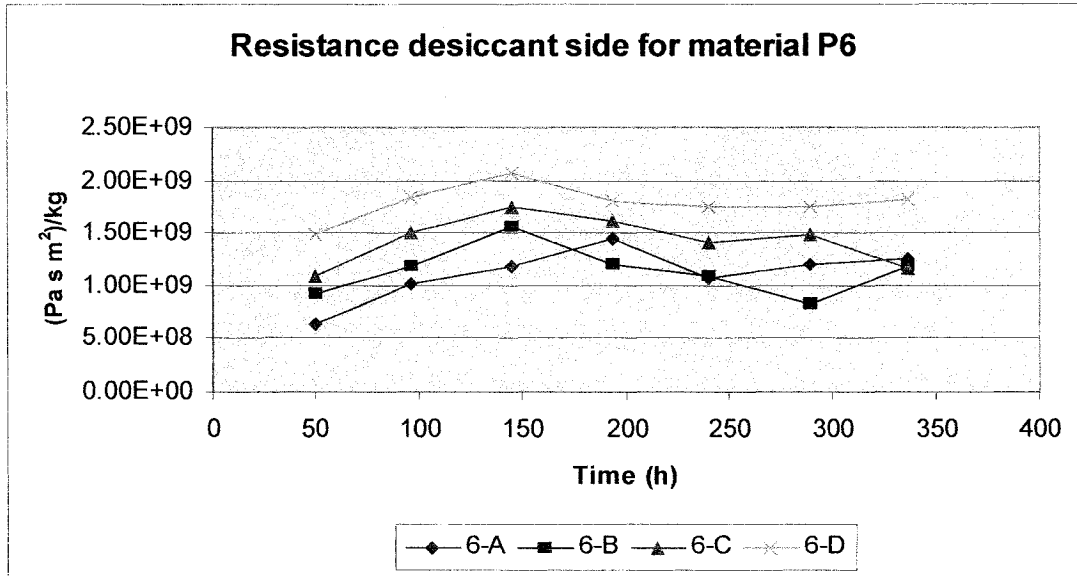

Average steady state resistance of desiccant side for material P6

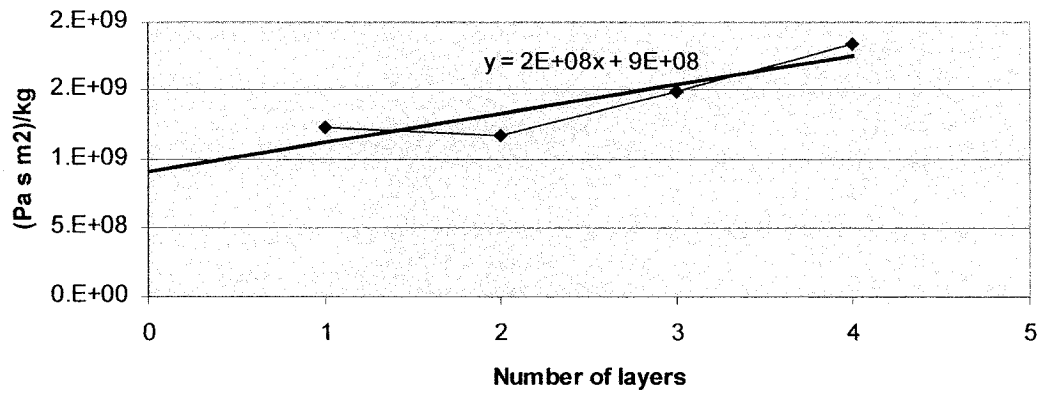

Material P6
 Modified inverted cup method (MIC)
 November 26th 2002 - Beginning of test
 Temperature control: +/- 1.5 °C

Area of specimen: 0.00793

Thickness of material P6 in mm
 Layer all Point 1 0.16 Point 2 0.16 Point 3 0.12 Point 4 0.14
 Averagethickness 0.145

Weight of paper in grammes
 6A 0.643

Table 1.: Recordings of weights for 6-A

Sr. No.	Time		Weights (1)				Temp. °C	Relative Humidity %	Pressure difference Δ P
	Date	Time	Hours	Wt. Of liquid Cup	New wt. Of Dry Cup	Wt. Of Dry Cup			
1	26/11/2002	16:15	0:00	0.000	N/A	238.024	107.295	19.2	2650
2	28/11/2002	17:45	49:50	0.000	229.443	243.592	107.354	21.0	2542
3	30/11/2002	16:45	47:00	0.000	229.473	232.484	107.403	21.8	2296
4	02/12/2002	17:15	48:50	0.000	230.738	232.171	107.444	23.1	2325
5	04/12/2002	18:15	49:00	0.000	232.093	233.294	107.468	22.1	2632
6	06/12/2002	17:00	46:75	0.000	231.823	235.011	107.490	22.5	2339
7	08/12/2002	17:00	48:00	0.000	228.177	234.549	107.512	23.6	2382
8	10/12/2002	16:15	48:25	0.000	N/A	230.743	107.545	22.6	2353

Table 2.: Water Vapour Transmission through material in 6-A

Sr. No.	Weight change in cups		Time			Weight change per unit time			q/A		Permeance		Resistance	
	Water Cup	Dry Cup	Specimen	Days	Hours	Seconds	dW/dt	dDes/dt (g/s)	dSp/dt	Solution Side (s m ³ /kg)	Desiccant Side (Pa s m ³ /kg)	Solution Side (Pa s m ³ /kg)	Desiccant Side (Pa s m ³ /kg)	
1	0.000	0.000	0.056	0	0:00	0	0.0000000	0.0000312	0.0000003	0.0000039	1.55E-09		6.45E+08	
2	0.000	5.568	0.056	2	49:50	178200	0.0000180	0.0000003	0.0000003	0.0000023	9.87E-10		1.01E+09	
3	0.000	3.041	0.045	2	47:00	169200	0.0000155	0.0000002	0.0000002	0.0000019	8.382E-10		1.19E+09	
4	0.000	2.698	0.041	2	48:50	174600	0.0000145	0.0000001	0.0000001	0.0000018	6.943E-10		1.44E+09	
5	0.000	2.556	0.044	2	49:00	176400	0.0000173	0.0000001	0.0000001	0.0000022	9.347E-10		1.07E+09	
6	0.000	2.918	0.022	2	46:75	168300	0.0000158	0.0000001	0.0000001	0.0000020	8.352E-10		1.20E+09	
7	0.000	2.726	0.025	2	48:00	172800	0.0000148	0.0000002	0.0000002	0.0000019	7.916E-10		1.26E+09	
8	0.000	2.566	0.033	2	48:25	173700								
										Average	1.12E+09			
										S.S.Average	1.233E+09			

Material P6
 Modified inverted cup method (MIC)
 November 26th 2002 - Beginning of test
 Temperature control: +- 1.5 °C

Area of specimen: 0.00793

Thickness of material P6 in mm
 Layer Point 1 Point 2 Point 3 Point 4
 all 0.28 0.28 0.3 0.23
 Averagethickness
 0.273

Weight of paper in grammes
 6B 1.275

Table 1.: Recordings of weights for 6-B

Sr. No.	Time		Weights (g)				Temp. °C	Relative Humidity %	Pressure difference Δ P
	Date	Time	Hours	Wt. Of liquid Cup	New wt. Of Dry Cup	Wt. Of Ring + Specimen			
1	26/11/2002	16:19	0.00	0.000	N/A	108.749	21.9	19.2	2650
2	28/11/2002	17:49	49.50	0.000	245.024	108.778	21.0	15.0	2542
3	30/11/2002	17:49	47.00	0.000	243.008	109.437	21.8	26.5	2296
4	02/12/2002	17:19	47.50	0.000	250.325	109.416	23.1	21.0	2811
5	04/12/2002	18:19	49.00	0.000	243.309	115.230	22.1	19.0	2396
6	06/12/2002	17:02	46.75	0.000	246.080	115.646	22.5	21.0	2396
7	08/12/2002	17:02	48.00	0.000	243.811	115.575	23.6	21.0	2325
8	10/12/2002	16:17	48.25	0.000	N/A	115.743	22.6	22.6	2339

Table 2.: Water Vapour Transmission through material in 6-B

Sr. No.	Weight change in cups		Time			Weight change per unit time			q/A		Permeance		Resistance		
	Water Cup	Dry Cup	Specimen	Days	Hours	Seconds	dW/dt	dDes/dt (g/s)	dSp/dt	Solution Side	Desiccant Side	Solution Side	Desiccant Side	Solution Side	Desiccant Side
1	0.990	0.000	0.100	0	0.00	0	0.0000000	0.0000000	0.0000000	0.0000028	0.0000028	1.082E-09	1.082E-09	9.24E+08	9.24E+08
2	0.996	3.888	0.929	2	49.50	178200	0.0000000	0.0000153	0.0000000	0.0000019	0.0000019	8.4E-10	8.4E-10	1.19E+09	1.19E+09
3	0.990	2.588	0.659	2	47.00	169200	0.0000000	0.0000143	0.0000000	0.0000018	0.0000018	6.408E-10	6.408E-10	1.56E+09	1.56E+09
4	0.995	2.442	0.929	2	47.50	171000	0.0000000	0.0000157	0.0000000	0.0000020	0.0000020	8.282E-10	8.282E-10	1.21E+09	1.21E+09
5	0.976	2.776	0.919	2	49.00	176400	0.0000000	0.0000175	0.0000000	0.0000022	0.0000022	9.221E-10	9.221E-10	1.08E+09	1.08E+09
6	0.990	2.949	0.419	2	46.75	168300	0.0000000	0.0000224	0.0000000	0.0000028	0.0000028	1.213E-09	1.213E-09	8.25E+08	8.25E+08
7	0.990	3.863	0.971	2	48.00	172800	0.0000000	0.0000157	0.0000000	0.0000020	0.0000020	8.46E-10	8.46E-10	1.18E+09	1.18E+09
8	0.990	2.726	0.102	2	48.25	173700	0.0000000	0.0000157	0.0000000	0.0000020	0.0000020	8.46E-10	8.46E-10	1.14E+09	1.14E+09
														Average	1.172E+09
														S.S.Average	1.172E+09

Material P6
 Modified inverted cup method (MIC)
 November 26th 2002 - Beginning of test
 Temperature control: +/- 1.5 °C

Area of specimen: 0.00793

Thickness of material P6 in mm
 Sample Layer all Point 1 0.38 Point 2 0.41 Point 3 0.4 Point 4 0.34
 Averagethickness 0.383

Weight of paper in grammes
 6C 1.84

Table 1.: Recordings of weights for 6-C

Sr. No.	Date	Time	Weights (1)		Temp. °C	Relative Humidity %	Pressure difference Δ P
			Wt. Of liquid Cup	Wt. Of Dry Cup			
1	26/11/2002	16:23	0.00	N/A	21.9	19.2	2650
2	28/11/2002	17:53	0.00	229.842	21.0	15.0	2542
3	30/11/2002	16:53	0.00	229.675	21.8	26.5	2632
4	02/12/2002	17:23	0.00	231.644	23.1	21.0	2811
5	04/12/2002	18:23	0.00	230.156	22.1	19.0	2396
6	06/12/2002	17:08	0.00	230.899	22.5	21.0	2396
7	08/12/2002	17:08	0.00	231.585	23.6	21.0	2325
8	10/12/2002	16:23	0.00	234.346	22.6	22.6	2339

Table 2.: Water Vapour Transmission through material in 6-C

Sr. No.	Weight change in cups		Time		Days		Weight change per unit time		q/A		Permeance		Resistance		
	Water Cup	Dry Cup	Specimen	Hours	Seconds	Days	Hours	Seconds	dW/dt	dDes/dt	dSp/dt	Solution Side	Desiccant Side	Solution Side	Desiccant Side
1	0.000	0.000	0.000	0.00	0	0	0.00	0	0.0000000	0.0000186	0.0000002			9.2431E-10	1.08E+09
2	0.000	3.320	0.042	49.50	178200	2	49.50	178200	0.0000000	0.0000140	0.0000004			6.6917E-10	1.49E+09
3	0.000	2.363	0.075	47.00	169200	2	47.00	169200	0.0000000	0.0000128	0.0000000			5.7281E-10	1.75E+09
4	0.000	2.229	0.074	48.50	174600	2	48.50	174600	0.0000000	0.0000117	0.0000001			6.1606E-10	1.62E+09
5	0.000	2.065	0.074	49.00	176400	2	49.00	176400	0.0000000	0.0000134	0.0000000			7.0637E-10	1.42E+09
6	0.000	2.259	0.076	46.75	168300	2	46.75	168300	0.0000000	0.0000125	0.0000000			6.777E-10	1.48E+09
7	0.000	2.159	0.074	48.00	172800	2	48.00	172800	0.0000000	0.0000159	0.0000000			8.5691E-10	1.17E+09
8	0.000	2.761	0.091	48.25	173700	2	48.25	173700	0.0000000	0.0000159	0.0000000			8.5691E-10	1.17E+09
Average															
SS Average															

Material P6
 Modified inverted cup method (MIC)
 November 26th 2002 - Beginning of test
 Temperature control: +/- 1.5 °C

Area of specimen: 0.00793

Thickness of material P6 in mm
 Sample Layer Point 1 Point 2 Point 3 Point 4
 6D all 0.49 0.55 0.5 0.56

Average thickness
 0.525

Weight of paper in grammes
 6D 2.505

Table 1.: Recordings of weights for 6-D

Sr. No.	Time		Weights (1)				Temp. °C	Relative Humidity %	Pressure difference Δ P
	Date	Time	Hours	Wt. Of liquid Cup	New wt. Of Dry Cup	Wt. Of Ring + Specimen			
1	26/11/2002	16:27	0:00	0.000	N/A	238.412	21.9	19.2	2650
2	28/11/2002	17:58	49:50	0.000	228.717	240.820	21.0	15.0	2542
3	30/11/2002	16:58	47:00	0.000	228.414	230.642	21.8	26.5	2632
4	02/12/2002	17:27	48:50	0.000	229.982	230.304	23.1	21.0	2811
5	04/12/2002	18:12	46:75	0.000	229.006	231.757	22.1	19.0	2396
6	06/12/2002	17:12	47:00	0.000	230.322	230.845	22.5	21.0	2396
7	08/12/2002	17:12	48:00	0.000	229.010	232.147	23.6	21.0	2325
8	10/12/2002	16:27	48:25	0.000	N/A	230.779	22.6	22.6	2339

Table 2.: Water Vapour Transmission through material in 6-D

Sr. No.	Weight change in cups		Time			Weight change per unit time			q/A		Permeance		Resistance			
	Water Cup	Dry Cup	Specimen	Days	Hours	Seconds	dW/dt	dDes/dt	dSp/dt	Solution Side	Desiccant Side	(Pa s m ³)/kg	Solution Side	Desiccant Side	(Pa s m ³)/kg	
1	0.000	0.000	0.000	0	0:00	0	0.0000000	0.0000135	0.0000003	0.0000017	0.0000014	6.704E-10	1.492E+09	1.834E+09		
2	0.000	2.408	0.045	2	49:50	178200	0.0000000	0.0000114	0.0000003	0.0000014	0.0000014	5.451E-10	1.834E+09	2.069E+09		
3	0.000	1.925	0.045	2	47:00	169200	0.0000000	0.0000108	0.0000000	0.0000014	0.0000013	4.857E-10	1.892E+09	1.748E+09		
4	0.000	1.890	0.030	2	48:50	174600	0.0000000	0.0000105	0.0000000	0.0000014	0.0000013	5.55E-10	1.748E+09	1.748E+09		
5	0.000	1.775	0.031	2	46:75	168300	0.0000000	0.0000109	0.0000001	0.0000014	0.0000013	5.72E-10	1.748E+09	1.748E+09		
6	0.000	1.839	0.017	2	47:00	169200	0.0000000	0.0000106	0.0000002	0.0000014	0.0000013	5.729E-10	1.748E+09	1.748E+09		
7	0.000	1.825	0.024	2	48:00	172800	0.0000000	0.0000102	0.0000001	0.0000013	0.0000013	5.49E-10	1.786E+09	1.835E+09		
8	0.000	1.769	0.011	2	48:25	173700	0.0000000	0.0000102	0.0000001	0.0000013	0.0000013	5.49E-10	1.786E+09	1.835E+09		
											Average	1.786E+09				
											S.S.Average	1.835E+09				

Material P6
Modified inverted cup (MIC)
Temperature control: $\pm 1.5^\circ\text{C}$

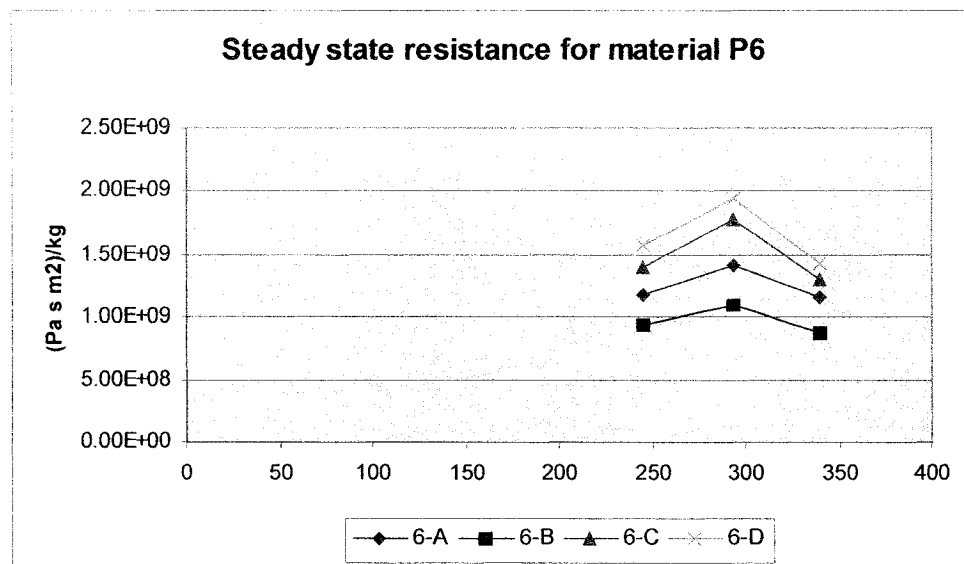
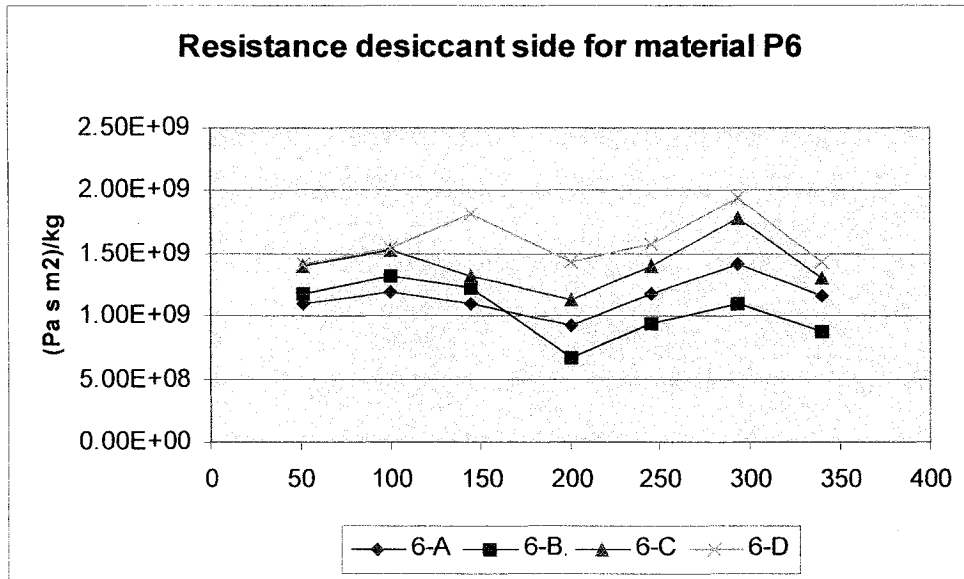

Steady state resistance intercept values for material P6

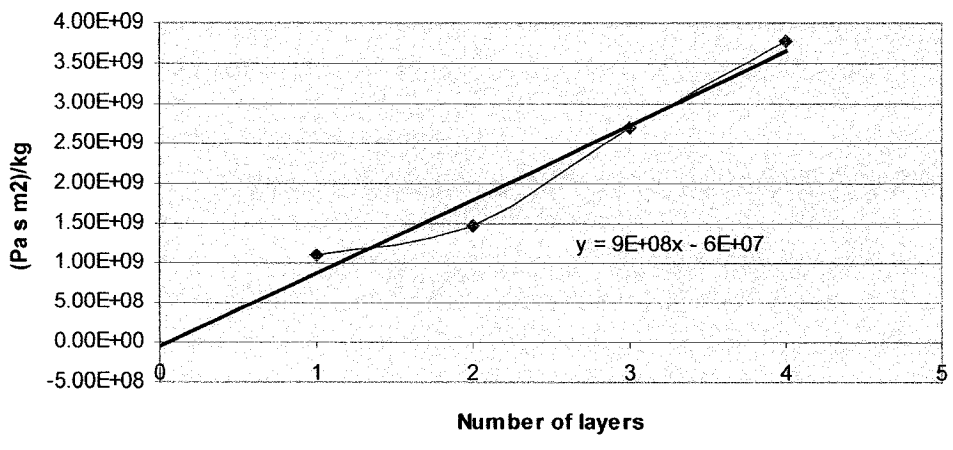

Material P6
 Modified inverted cup method (MIC)
 August 3rd 2002 - Beginning of test
 Temperature control: +/- 1.5 °C

Area of specimen: 0.00793 sq.m.

Thickness of material P6 in mm

Sample Layer Point 1 Point 2 Point 3 Point 4 Average thickness
 6-A 1 0.15 0.15 0.14 0.15 0.148

Weight of paper in grammes
 6-A 0.65

Table 1: Recordings of weights for 6-A

Sr. No.	Time		Hours	Weights (1)		Temp. °C	Relative Humidity %	Pressure difference Δ P
	Date	Time		Wt. Of liquid Cup	New wt. Of Dry Cup			
1	03/08/2002	11:50	0.00	0.000	N/A	409.380	51.0	2968
2	05/08/2002	14:20	51.50	0.000	406.914	413.227	53.0	2863
3	07/08/2002	14:50	48.50	0.000	407.790	410.260	44.0	2898
4	09/08/2002	11:50	45.00	0.000	457.720	411.170	47.0	2880
5	11/08/2002	18:50	55.00	0.000	407.370	462.740	49.0	2950
6	13/08/2002	15:20	45.50	0.000	407.270	410.800	55.6	3114
7	15/08/2002	15:15	47.92	0.000	406.415	410.380	55.4	3208
8	17/08/2002	14:15	46.00	0.000	N/A	409.940	49.0	3132

Table 2: Water Vapour Transmission through material in 6-A

Sr. No.	Weight change in cups		Time		Weight change per unit time		q/A	Permeance		Resistance			
	Water Cup	Dry Cup	Specimen	Days	Hours	Seconds		dW/dt	dDes/dt	dSp/dt	Solution Side	Desiccant Side	Solution Side
1	0.000	0.000	0.000	0	0.00	0	0.0000000	0.0000207	0.0000001	0.0000028	9.14E-10	1.09E+09	1.09E+09
2	0.000	3.847	0.015	2	51.50	185400	0.0000000	0.0000192	0.0000001	0.0000024	8.339E-10	1.20E+09	1.20E+09
3	0.000	3.346	0.015	2	48.50	174600	0.0000000	0.0000209	0.0000011	0.0000026	9.134E-10	1.09E+09	1.09E+09
4	0.000	3.380	0.180	2	45.00	162000	0.0000000	0.0000254	0.0000001	0.0000032	1.084E-09	9.23E+08	9.23E+08
5	0.000	5.020	0.020	2	55.00	198000	0.0000000	0.0000209	-0.0000015	0.0000026	8.48E-10	1.18E+09	1.18E+09
6	0.000	3.430	-0.250	2	45.50	163800	0.0000000	0.0000180	0.0000002	0.0000023	7.087E-10	1.41E+09	1.41E+09
7	0.000	3.110	0.035	2	47.92	172500	0.0000000	0.0000213	0.0000002	0.0000027	8.569E-10	1.17E+09	1.17E+09
8	0.000	3.525	0.035	2	46.00	165600	0.0000000	0.0000213	0.0000002	0.0000027	8.569E-10	1.17E+09	1.17E+09
											Average	1.15E+09	
											S.S.Average	1.25E+09	

Material P6
Modified inverted cup method (MIC)
August 3rd 2002 - Beginning of test
Temperature control: +/- 1.5 °C

Area of specimen: 0.00793 sq.m.

Thickness of material P6 in mm

Sample Layer	Point 1	Point 2	Point 3	Point 4	Average thickness per layer
1	0.14	0.14	0.14	0.14	0.14
2	0.12	0.14	0.12	0.14	0.13
					Average thickness 0.270

Weight of paper in grammes

6-B 1.28

Table 1.: Recordings of weights for 6-B

Sr. No.	Time		Wt. Of liquid Cup	Weights (1)		Temp. °C	Relative Humidity %	Pressure difference Δ P
	Date	Hours		New wt. Of Dry Cup	Wt. Of Ring + Specimen			
1	03/08/2002	11:55	0.00	N/A	412.850	23.9	51.0	2968
2	05/08/2002	14:25	0.00	412.441	416.406	23.3	53.0	2863
3	07/08/2002	14:55	0.00	414.070	415.460	23.5	44.0	2898
4	09/08/2002	11:55	0.00	461.970	417.070	23.1	47.0	2880
5	11/08/2002	18:55	0.00	411.470	488.970	23.8	49.0	2950
6	13/08/2002	15:25	0.00	410.430	415.700	24.7	55.6	3114
7	15/08/2002	15:15	0.00	412.520	414.420	25.8	55.4	3208
8	17/08/2002	14:15	0.00	N/A	417.260	24.8	49.0	3132

Table 2.: Water Vapour Transmission through material in 6-B

Sr. No.	Weight change in cups		Time		Weight change per unit time		g/A		Permeance		Resistance	
	Water Cup	Dry Cup	Days	Hours	dW/dt	dDes/dt (g/s)	Solution Side	Desiccant Side	Solution Side	Desiccant Side	Solution Side	Desiccant Side
1	0.000	0.000	0	0:00	0.0000000	0.0000192	0.0000024	0.0000001	8.448E-10	1.18E+09	1.18E+09	8.448E-10
2	0.000	3.556	2	51:50	0.0000000	0.0000173	0.0000001	0.0000001	7.524E-10	1.33E+09	1.33E+09	7.524E-10
3	0.000	3.019	2	48:50	0.0000000	0.0000185	0.0000023	0.0000001	8.107E-10	1.23E+09	1.23E+09	8.107E-10
4	0.000	3.000	2	45:00	0.0000000	0.0000354	0.0000045	0.0000001	1.511E-09	6.62E+08	6.62E+08	1.511E-09
5	0.000	7.000	2	55:00	0.0000000	0.0000284	0.0000033	0.0000001	1.069E-09	9.35E+08	9.35E+08	1.069E-09
6	0.000	4.230	2	44:50	0.0000000	0.0000231	0.0000029	0.0000001	9.092E-10	1.10E+09	1.10E+09	9.092E-10
7	0.000	3.990	2	47:92	0.0000000	0.0000286	0.0000036	0.0000001	1.152E-09	8.68E+08	8.68E+08	1.152E-09
8	0.000	4.740	3	46:00	0.0000000	0.0000004	0.0000004	Average	1.044E+09	9.68E+08	9.68E+08	1.044E+09

Material P6
 Modified inverted cup method (MIC)
 August 3rd 2002 - Beginning of test
 Temperature control: +/- 1.6 °C

Area of specimen: 0.00793 sq. m.

Thickness of material P6 in mm

Sample Layer	Point 1	Point 2	Point 3	Point 4	Average thickness per layer
1	0.11	0.13	0.15	0.14	0.1325
2	0.14	0.15	0.14	0.15	0.145
3	0.15	0.13	0.13	0.14	0.1375
Average thickness					0.415

Weight of paper in grammes
 6-C 1.82

Table 1.: Recordings of weights for 6-C

Sr. No.	Date	Time		Hours	Weights (1)		Temp. °C	Relative Humidity %	Pressure difference Δ P
		Dry Cup	Wt. Of Liquid Cup		New wt. Of Dry Cup	Wt. Of Ring + Specimen			
1	03/08/2002	12:00	0.00	0.00	413.180	N/A	23.9	51.0	2968
2	05/08/2002	15:30	51.50	0.00	416.180	411.723	23.3	53.0	2863
3	07/08/2002	16:00	48.50	0.00	415.100	414.360	23.5	44.0	2898
4	09/08/2002	12:00	44.00	0.00	463.200	417.840	23.1	47.0	2880
5	11/08/2002	19:00	55.00	0.00	412.950	412.950	23.8	49.0	2950
6	13/08/2002	15:30	44.50	0.00	412.920	415.770	24.7	55.6	3114
7	15/08/2002	15:20	47.83	0.00	411.950	415.380	25.8	55.4	3208
8	17/08/2002	14:20	46.00	0.00	415.090	415.090	24.8	49.0	3132

Table 2.: Water Vapour Transmission through material in 6-C

Sr. No.	Weight change in cups		Specimen	Time		Weight change per unit time		q/A		Permeance		Resistance	
	Water Cup	Dry Cup		Days	Hours	dW/dt	dDes/dt (g/s)	Solution Side	Desiccant Side	Solution Side	Desiccant Side	Solution Side	Desiccant Side
1	0.000	0.000	0.000	0.00	0.00	0.0000000	0.0000162	0.0000000	0.0000020	7.127E-10	7.127E-10	1.40E+09	1.40E+09
2	0.000	3.000	0.002	51.50	185400	0.0000000	0.0000151	-0.0000004	0.0000019	6.572E-10	6.572E-10	1.52E+09	1.52E+09
3	0.000	2.637	-0.062	48.50	174600	0.0000000	0.0000173	0.0000020	0.0000022	7.573E-10	7.573E-10	1.32E+09	1.32E+09
4	0.000	2.740	0.310	44.00	158400	0.0000000	0.0000206	0.0000002	0.0000026	8.808E-10	8.808E-10	1.14E+09	1.14E+09
5	0.000	4.080	0.030	55.00	198000	0.0000000	0.0000176	-0.0000019	0.0000022	7.128E-10	7.128E-10	1.40E+09	1.40E+09
6	0.000	2.820	-0.310	44.50	160200	0.0000000	0.0000143	-0.0000003	0.0000018	5.615E-10	5.615E-10	1.78E+09	1.78E+09
7	0.000	2.460	-0.060	47.83	172200	0.0000000	0.0000190	0.0000007	0.0000024	7.633E-10	7.633E-10	1.31E+09	1.31E+09
8	0.000	3.140	0.110	46.00	165600	0.0000000	0.0000000	0.0000000	0.0000000	Average	Average	1.411E+09	1.411E+09
											S.S.Average	1.50E+09	

Material P6
 Modified inverted cup method (MIC)
 August 3rd 2002 - Beginning of test
 Temperature control: +/- 1.5 °C

Area of specimen: 0.00793 sq.m.

Thickness of material P6 in mm

Sample Layer	Point 1	Point 2	Point 3	Point 4	Average thickness per layer
6-D 1	0.15	0.14	0.13	0.14	0.14
2	0.16	0.15	0.14	0.14	0.1475
3	0.15	0.13	0.13	0.14	0.1375
4	0.14	0.12	0.14	0.15	0.1375
					Average thickness 0.141

Weight of paper in grammes

6-D	2.42
-----	------

Table 1: Recordings of weights for 6-D

Sr. No.	Date		Time		Weights (g)		Temp. °C	Relative Humidity %	Pressure difference Δ P
	Time	Hours	Wt. Of liquid Cup	New wt. Of Dry Cup	Wt. Of Ring + Specimen				
1	03/08/2002	12:05	0.00	N/A	413.700	108.350	23.9	51.0	2968
2	05/08/2002	15:35	51.50	410.210	416.664	108.316	23.3	53.0	2863
3	07/08/2002	16:05	48.50	412.430	412.810	108.320	23.5	44.0	2898
4	09/08/2002	12:05	44.00	461.560	414.430	108.560	23.1	47.0	2880
5	11/08/2002	19:05	55.00	411.940	464.780	108.740	23.8	49.0	2950
6	13/08/2002	15:35	44.50	413.720	414.460	108.280	24.7	55.6	3114
7	15/08/2002	15:20	47.75	412.170	415.980	108.240	25.8	55.4	3208
8	17/08/2002	14:20	46.00	N/A	415.025	108.330	24.8	49.0	3132

Table 2: Water Vapour Transmission through material in 6-D

Sr. No.	Weight change in cups		Time		Weight change per unit time		q/A		Permeance		Resistance	
	Water Cup	Dry Specimen	Days	Hours	dW/dt	dDes/dt (g/s)	dSp/dt	Solution Side	Desiccant Side	Solution Side	Desiccant Side	Resistance (Pa s m ² /kg)
1	0.000	0.000	0	0.00	0.0000000	0.0000000	-0.0000002	0.0000020	0.0000000	7.042E-10	1.42E+09	1.42E+09
2	0.000	2.964	2	51.50	0.0000000	0.0000000	0.0000000	0.0000000	0.0000000	6.48E-10	1.543E+09	1.543E+09
3	0.000	2.600	2	48.50	0.0000000	0.0000000	0.0000000	0.0000000	0.0000000	5.528E-10	1.809E+09	1.809E+09
4	0.000	2.000	2	44.00	0.0000000	0.0000000	0.0000015	0.0000000	0.0000000	6.951E-10	1.439E+09	1.439E+09
5	0.000	3.220	2	55.00	0.0000000	0.0000000	0.0000000	0.0000000	0.0000000	6.37E-10	1.57E+09	1.57E+09
6	0.000	2.520	2	44.50	0.0000000	0.0000000	-0.0000029	0.0000000	0.0000000	5.168E-10	1.935E+09	1.935E+09
7	0.000	2.260	2	47.75	0.0000000	0.0000000	0.0000000	0.0000000	0.0000000	6.94E-10	1.441E+09	1.441E+09
8	0.000	2.855	3	46.00	0.0000000	0.0000000	0.0000005	0.0000000	0.0000000			
Average												1.594E+09
S.S. Average												1.849E+09

Material P8
Modified inverted cup (MIC)
Temperature control: $\pm 1.5^\circ\text{C}$

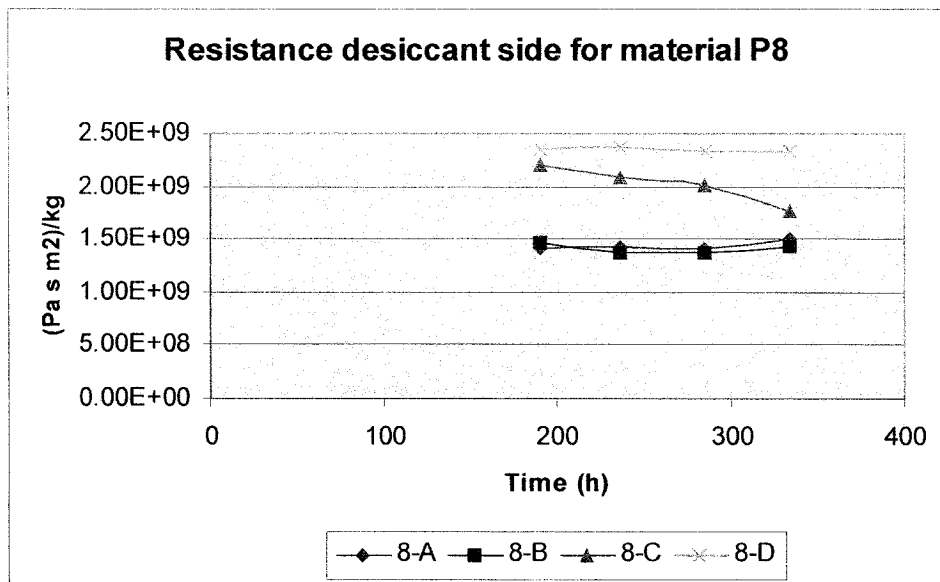
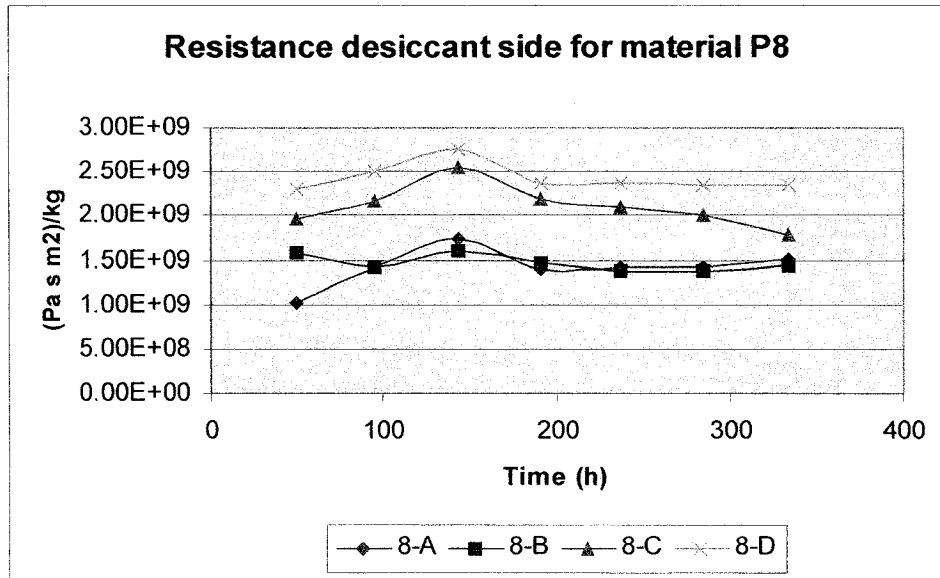

Average steady state resitsance of desiccant side for material P8

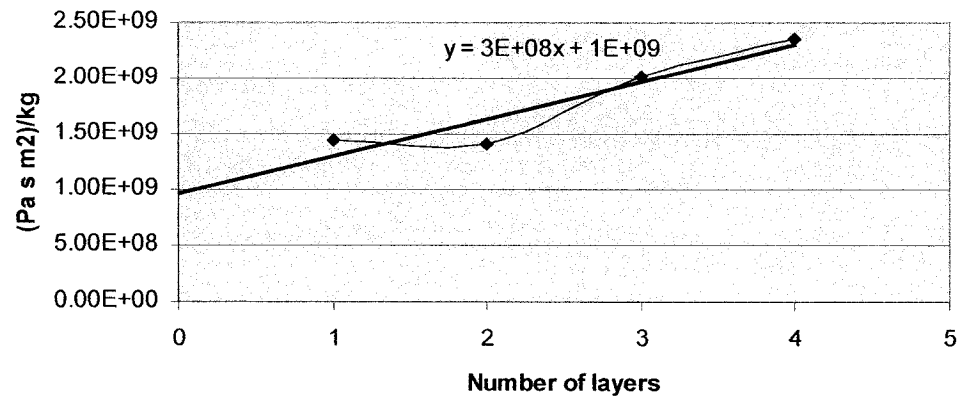

Material P8
 Modified inverted cup method (MIC)
 November 26th 2002 - Beginning of test
 Temperature control: +/- 1.5 °C

Area of specimen: 0.00793

Thickness of material P8 in mm
 Sample Layer all Point 1 0.17 Point 2 0.17 Point 3 0.17 Point 4 0.19
 Averagethickness 0.175

Weight of paper in grammes
 8A 0.956

Table 1.: Recordings of weights for 8-A

Sr. No.	Time		Weights				Temp. °C	Relative Humidity %	Pressure difference Δ P
	Date	Time	Hours	Wt. Of liquid Cup	New wt. Of Dry Cup	Wt. Of Dry Cup			
1	26/11/2002	16:31	0.00	0.000	N/A	232.026	110.875	19.2	2650
2	28/11/2002	18:01	49.50	0.000	231.242	235.598	110.732	15.0	2542
3	30/11/2002	16:01	46.00	0.000	232.246	233.672	110.783	26.5	2632
4	02/12/2002	17:31	48.50	0.000	233.323	234.494	110.802	21.0	2811
5	04/12/2002	18:16	46.75	0.000	231.473	235.601	110.838	19.0	2396
6	06/12/2002	17:01	46.75	0.000	233.940	233.706	110.856	21.0	2396
7	08/12/2002	17:01	48.00	0.000	232.062	236.199	110.872	23.6	2325
8	10/12/2002	16:16	48.25	0.000	N/A	234.195	110.906	22.6	2339

Table 2.: Water Vapour Transmission through material in 8-A

Sr. No.	Weight change in cups			Time			Weight change per unit time			q/A		Permeance		Resistance	
	Water Cup	Dry Cup	Specimen	Days	Hours	Seconds	dW/dt	dDes/dt (g/s)	dSp/dt	Solution Side	Desiccant Side	Solution Side	Desiccant Side	Solution Side	Desiccant Side
1	0.000	0.000	0.000	0	0.00	0	0.0000000	0.0000200	0.0000003	0.0000025	0.0000019	9.9446E-10	1.01E+09	1.42E+09	1.42E+09
2	0.000	3.572	0.057	2	49.50	178200	0.0000000	0.0000147	0.0000003	0.0000019	0.0000019	7.031E-10	1.42E+09	1.42E+09	1.42E+09
3	0.000	2.430	0.051	2	46.00	165600	0.0000000	0.0000129	0.0000001	0.0000016	0.0000016	5.7789E-10	1.73E+09	1.73E+09	1.73E+09
4	0.000	2.248	0.049	2	48.50	174600	0.0000000	0.0000135	0.0000002	0.0000017	0.0000017	7.1231E-10	1.40E+09	1.40E+09	1.40E+09
5	0.000	2.278	0.048	2	46.75	168300	0.0000000	0.0000133	0.0000001	0.0000017	0.0000017	6.9824E-10	1.43E+09	1.43E+09	1.43E+09
6	0.000	2.233	0.048	2	46.75	168300	0.0000000	0.0000131	0.0000001	0.0000016	0.0000016	7.0909E-10	1.41E+09	1.41E+09	1.41E+09
7	0.000	2.259	0.046	2	48.00	172800	0.0000000	0.0000123	0.0000002	0.0000015	0.0000015	6.62E-10	1.51E+09	1.51E+09	1.51E+09
8	0.000	2.133	0.044	2	48.25	173700	0.0000000	0.0000123	0.0000002	0.0000015	0.0000015	6.62E-10	1.51E+09	1.51E+09	1.51E+09
										Average	1.42E+09	1.42E+09	1.42E+09	1.42E+09	1.42E+09
										S.S. Average	1.439E+09	1.439E+09	1.439E+09	1.439E+09	1.439E+09

Material P8
 Modified inverted cup method (MIC)
 November 26th 2002 - Beginning of test
 Temperature control: +/- 1.5 °C

Area of specimen: 0.00793

Thickness of material P8 in mm
 Sample Layer Point 1 Point 2 Point 3 Point 4
 8B all 0.32 0.34 0.33 0.33
 Averagethickness
 0.330

Weight of paper in grammes
 8B 1.958

Table 1.: Recordings of weights for 8-B

Sr. No.	Time		Hours	Weights (1)		Temp. °C	Relative Humidity %	Pressure difference Δ P
	Date	Time		Wt. Of liquid Cup	New wt. Of Dry Cup			
1	26/11/2002	16:35	0.00	0.000	N/A	21.9	19.2	2650
2	28/11/2002	18:05	49.50	0.000	230.349	21.0	15.0	2542
3	30/11/2002	17:05	47.00	0.000	230.179	21.8	26.5	2632
4	02/12/2002	17:50	46.75	0.000	235.148	23.1	21.0	2811
5	04/12/2002	18:20	48.50	0.000	231.527	22.1	19.0	2396
6	06/12/2002	17:05	46.75	0.000	231.027	22.5	21.0	2396
7	08/12/2002	17:05	48.00	0.000	230.264	23.6	21.0	2325
8	10/12/2002	16:35	47.50	0.000	N/A	22.6	22.6	2339

Table 2.: Water Vapour Transmission through material in 8-B

Sr. No.	Weight change in cups		Time		Weight change per unit time		q/A		Permeance		Resistance	
	Water Cup	Dry Cup	Days	Hours	dW/dt	dDes/dt	Solution Side	Desiccant Side	Solution Side	Desiccant Side	Solution Side	Desiccant Side
1	0.000	0.000	0	0.00	0.0000000	0.0000128	0.0000016	0.0000016	6.3643E-10	1.57E+09		
2	0.000	2.286	2	49.50	0.0000000	0.0000146	0.0000018	0.0000018	6.9976E-10	1.43E+09		
3	0.000	2.471	2	47.00	0.0000000	0.0000139	0.0000018	0.0000018	6.2304E-10	1.61E+09		
4	0.000	2.337	2	46.75	0.0000000	0.0000129	0.0000016	0.0000016	6.7817E-10	1.47E+09		
5	0.000	2.250	2	48.50	0.0000000	0.0000139	0.0000018	0.0000018	7.3107E-10	1.37E+09		
6	0.000	2.338	2	46.75	0.0000000	0.0000134	0.0000017	0.0000017	7.2478E-10	1.38E+09		
7	0.000	2.309	2	48.00	0.0000000	0.0000129	0.0000016	0.0000016	6.9673E-10	1.44E+09		
8	0.000	2.210	2	47.50	0.0000000	0.0000129	0.0000016	0.0000016			Average	1.466E+09
											S.S.Average	1.414E+09

Material P8
 Modified inverted cup method (MIC)
 November 26th 2002 - Beginning of test
 Temperature control: +/- 1.5 °C

Area of specimen: 0.00793

Thickness of material P8 in mm:

Sample Layer all Point 1 0.45 Point 2 0.49 Point 3 0.5 Point 4 0.44
 Averagethickness 0.470

Weight of paper in grammes
 8C 2.82

Table 1.: Recordings of weights for 8-C

Sr. No.	Time		Weights (1)				Temp. °C	Relative Humidity %	Pressure difference Δ P	
	Date	Time	Hours	Wt. Of liquid Cup	New wt. Of Dry Cup	Wt. Of Dry Cup				Wt. Of Ring + Specimen
1	28/11/2002	16:39	0.00	0.000	N/A	262.956	107.821	21.9	19.2	2850
2	28/11/2002	18:09	49.50	0.000	262.733	264.782	107.880	21.0	15.0	2542
3	30/11/2002	17:09	47.00	0.000	261.495	264.368	107.917	21.8	26.5	2632
4	02/12/2002	17:39	48.50	0.000	263.981	263.024	107.913	23.1	21.0	2811
5	04/12/2002	18:24	48.75	0.000	262.298	265.500	107.957	22.1	19.0	2396
6	06/12/2002	17:24	47.00	0.000	263.272	263.835	108.087	22.5	21.0	2396
7	08/12/2002	17:24	48.00	0.000	262.985	264.862	108.722	23.6	21.0	2325
8	10/12/2002	16:54	47.50	0.000	N/A	264.773	130.929	22.6	22.6	2339

Table 2.: Water Vapour Transmission through material in 8-C

Sr. No.	Weight change in cups		Time			Weight change per unit time			q/A		Permeance		Resistance	
	Water Cup	Dry Cup	Days	Hours	Seconds	dW/dt	dDes/dt (g/s)	dSp/dt	Solution Side (s m ³ /kg)	Desiccant Side	Solution Side (Pa s m ³ /kg)	Desiccant Side	Solution Side (Pa s m ³ /kg)	
1	0.997	0.000	0	0.00	0	0.0000000	0.0000102	0.0000002	0.0000013		5.0837E-10		1.97E+09	
2	0.992	1.826	2	49.50	178200	0.0000000	0.0000097	0.0000002	0.0000012		4.6301E-10		2.16E+09	
3	0.990	1.635	2	47.00	169200	0.0000000	0.0000088	0.0000002	0.0000011		3.9292E-10		2.55E+09	
4	0.976	1.529	2	48.50	174600	0.0000000	0.0000087	0.0000002	0.0000011		4.5549E-10		2.20E+09	
5	0.996	1.519	2	48.75	175500	0.0000000	0.0000091	0.0000002	0.0000011		4.7805E-10		2.09E+09	
6	0.996	1.537	2	47.00	169200	0.0000000	0.0000092	0.0000002	0.0000012		4.9909E-10		2.00E+09	
7	0.990	1.590	2	48.00	172800	0.0000000	0.0000105	0.0000002	0.0000013		5.6369E-10		1.77E+09	
8	0.986	1.788	2	47.50	171000	0.0000000	0.0000105	0.0000002	0.0000013		5.6369E-10		1.77E+09	
											Average	2.11E+09		
											S.S. Average	2.016E+09		

Material P8
 Modified inverted cup method (MIC)
 November 26th 2002 - Beginning of test
 Temperature control: +/- 1.5 °C

Area of specimen: 0.00793

Thickness of material P8 in mm

Sample Layer all Point 1 0.65 Point 2 0.67 Point 3 0.67 Point 4 0.7
 Averagethickness 0.670

Weight of paper in grammes
 8D 3.832

Table 1.: Recordings of weights for 8-D

Sr. No.	Time		Weights (1)		Temp. °C	Relative Humidity %	Pressure difference Δ P
	Date	Hours	Wt. Of liquid Cup	New wt. Of Dry Cup			
1	26/11/2002	16:43	0.00	N/A	21.9	19.2	2650
2	28/11/2002	18:12	49.50	231.896	21.0	15.0	2542
3	30/11/2002	17:12	47.00	233.838	21.8	26.5	2632
4	02/12/2002	17:43	48.50	232.933	23.1	21.0	2811
5	04/12/2002	18:27	46.75	230.992	22.1	19.0	2396
6	06/12/2002	17:27	47.00	232.911	22.5	21.0	2396
7	08/12/2002	17:27	48.00	231.394	23.6	21.0	2325
8	10/12/2002	16:43	47.50	232.751	22.6	22.6	2339

Table 2.: Water Vapour Transmission through material in 8-D

Sr. No.	Weight change in cups		Time		Weight change per unit time		q/A		Permeance		Resistance	
	Water Cup	Dry Cup	Days	Hours	Seconds	dW/dt	dDes/dt	dSp/dt	Solution Side	Desiccant Side	Solution Side	Desiccant Side
1	0.000	0.000	0	0.00	0	0.0000000	0.0000087	0.0000000	0.0000011	0.0000010	4.3376E-10	2.31E+09
2	0.000	1.558	2	49.50	178200	0.0000000	0.0000083	0.0000001	0.0000010	0.0000010	3.9844E-10	2.51E+09
3	0.000	1.407	2	47.00	169200	0.0000000	0.0000081	0.0000001	0.0000010	0.0000010	3.6388E-10	2.75E+09
4	0.000	1.416	2	48.50	174600	0.0000000	0.0000081	0.0000001	0.0000010	0.0000010	4.2407E-10	2.36E+09
5	0.000	1.356	2	46.75	168300	0.0000000	0.0000080	0.0000001	0.0000010	0.0000010	4.2113E-10	2.37E+09
6	0.000	1.354	2	47.00	169200	0.0000000	0.0000079	0.0000001	0.0000010	0.0000010	4.2815E-10	2.34E+09
7	0.000	1.384	2	48.00	172800	0.0000000	0.0000079	0.0000001	0.0000010	0.0000010	4.2781E-10	2.34E+09
8	0.000	1.357	2	47.50	171000	0.0000000	0.0000079	0.0000001	0.0000010	0.0000010	4.2781E-10	2.34E+09
Average											2.424E+09	
S.S. Average											2.352E+09	

Material P8
Modified inverted cup (MIC)
Temperature control: $\pm 1.5^\circ\text{C}$

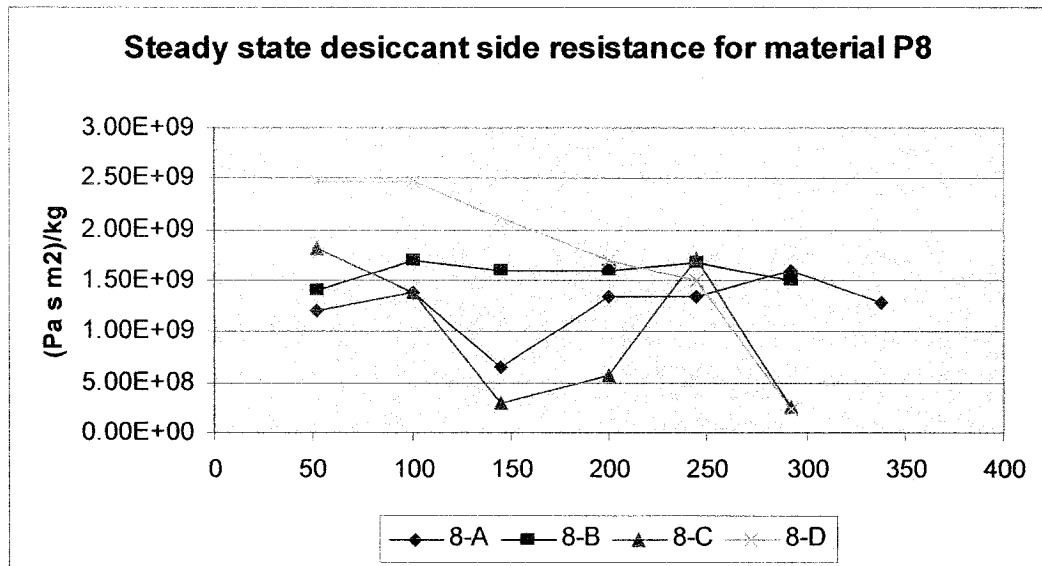
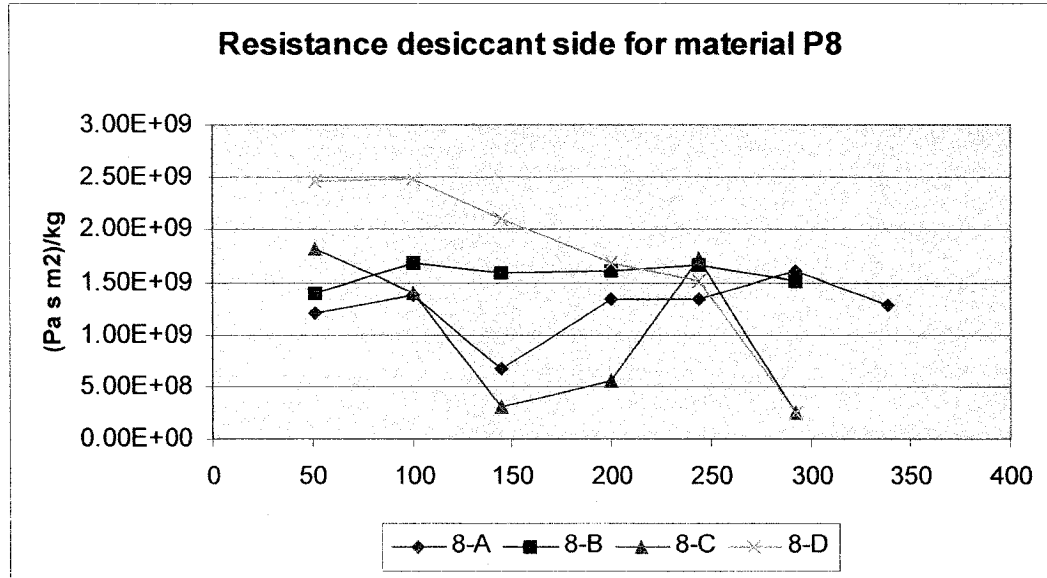

Steady state resistance intercept values for material P8

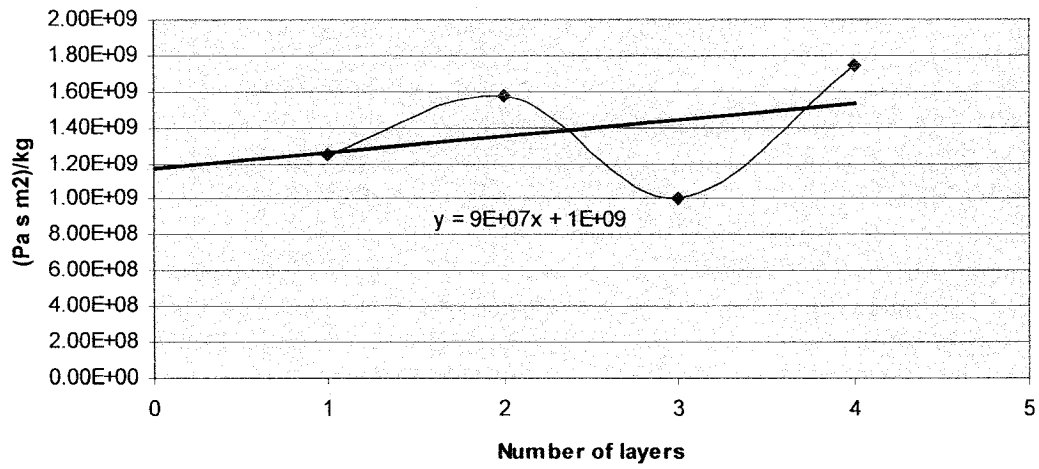

Material P8
 Modified inverted cup method (MIC)
 August 3rd 2002 - Beginning of test
 Temperature control: +/- 1.5 °C

Area of specimen: 0.00793 sq.m.

Thickness of material P8 in mm

Sample Layer Point 1 Point 2 Point 3 Point 4 Average thickness
 8-A 1 0.16 0.17 0.14 0.17 0.160

Weight of paper in grammes
 8-A 0.95

Table 1.: Recordings of weights for 8-A

Sr. No.	Time		Weights (1)				Temp. °C	Relative Humidity %	Pressure difference Δ P
	Date	Hours	Wt. Of liquid Cup	New wt. Of Dry Cup	Wt. Of Dry Cup	Wt. Of Ring + Specimen			
1	03/08/2002	11:30	0.000	N/A	228.930	106.070	23.9	51.0	2968
2	05/08/2002	15:00	0.000	225.508	232.432	106.046	23.3	53.0	2863
3	07/08/2002	15:30	0.000	225.230	228.410	106.060	23.5	44.0	2898
4	09/08/2002	12:30	0.000	226.020	230.830	106.130	23.1	47.0	2880
5	11/08/2002	19:30	0.000	226.970	229.460	106.180	23.8	49.0	2950
6	13/08/2002	16:00	0.000	225.470	229.920	106.050	24.7	55.6	3114
7	15/08/2002	15:55	0.000	225.400	228.210	106.090	25.8	55.4	3208
8	17/08/2002	14:55	0.000	N/A	228.590	106.160	24.8	49.0	3132

Table 2.: Water Vapour Transmission through material in 8-A

Sr. No.	Weight change in cups		Time			Weight change per unit time		q/A		Permeance		Resistance		
	Water Cup	Dry Cup Specimen	Days	Hours	Seconds	dW/dt	dDes/dt (g/s)	dSp/dt	Solution Side	Desiccant Side	Solution Side	Desiccant Side	Solution Side	Desiccant Side
1	0.000	0.000	0	0.00	0	0.0000000	0.0000189	-0.0000001	0.0000024	0.0000021	8.32E-10	8.32E-10	1.20E+09	1.20E+09
2	0.000	3.502	2	51.50	185400	0.0000000	0.0000166	0.0000001	0.0000021	0.0000021	7.233E-10	7.233E-10	1.38E+09	1.38E+09
3	0.000	2.902	2	48.50	174600	0.0000000	0.0000346	0.0000004	0.0000044	0.0000044	1.513E-09	1.513E-09	6.61E+08	6.61E+08
4	0.000	5.600	2	45.00	162000	0.0000000	0.0000174	0.0000003	0.0000022	0.0000022	7.426E-10	7.426E-10	1.35E+09	1.35E+09
5	0.000	3.440	2	54.50	198000	0.0000000	0.0000184	-0.0000008	0.0000023	0.0000023	7.457E-10	7.457E-10	1.34E+09	1.34E+09
6	0.000	2.950	2	47.92	172500	0.0000000	0.0000159	0.0000002	0.0000020	0.0000020	6.244E-10	6.244E-10	1.60E+09	1.60E+09
7	0.000	2.740	2	46.00	165600	0.0000000	0.0000193	0.0000004	0.0000024	0.0000024	7.755E-10	7.755E-10	1.29E+09	1.29E+09
8	0.000	3.190	2	46.00	165600	0.0000000	0.0000193	0.0000004	0.0000024	0.0000024	7.755E-10	7.755E-10	1.29E+09	1.29E+09
Average														1.256E+09

Material P8
 Modified inverted cup method (MIC)
 August 3rd 2002 - Beginning of test
 Temperature control: $\pm 1.5^\circ\text{C}$

Area of specimen: 0.00793 sq.m.

Thickness of material P8 in mm

Sample Layer	Point 1	Point 2	Point 3	Point 4	Average thickness per layer
1	0.19	0.15	0.18	0.17	0.1725
2	0.18	0.15	0.16	0.22	0.1775
Average thickness					0.350

Weight of paper in grammes
 8-B 1.86

Table 1: Recordings of weights for 8-B

Sr. No.	Time		Weights (1)		Temp. $^\circ\text{C}$	Relative Humidity %	Pressure difference ΔP
	Date	Hours	Wt. Of liquid Cup	New wt. Of Dry Cup			
1	03/08/2002	11:35	0.00	N/A	415.080	111.360	2968
2	05/08/2002	15:05	51.50	413.026	418.100	111.363	2863
3	07/08/2002	15:35	48.50	415.050	415.400	111.400	2898
4	09/08/2002	12:05	45.00	413.380	417.370	111.490	2880
5	11/08/2002	19:05	55.00	412.860	416.260	111.620	2950
6	13/08/2002	15:35	44.50	412.870	415.230	111.350	3114
7	15/08/2002	15:55	48.33	411.740	415.605	117.440	3208
8	17/08/2002	14:55	46.00	0.000	Leakage	115.255	3132

Table 2: Water Vapour Transmission through material in 8-B

Sr. No.	Weight change in cups		Time		Weight change per unit time		g/A	Permeance		Resistance		
	Water Cup	Dry Cup	Specimen	Days	Hours	Seconds		dW/dt	dDes/dt (g/s)	Solution Side	Desiccant Side	Solution Side
1	0.000	0.000	0.000	0	0.00	0	0.0000000	0.0000000	0.0000000	0.0000021	7.175E-10	1.394E+09
2	0.000	3.020	0.003	2	51.50	185400	0.0000000	0.0000163	0.0000000	0.0000017	5.917E-10	1.69E+09
3	0.000	2.374	0.037	2	48.50	174600	0.0000000	0.0000136	0.0000002	0.0000018	6.27E-10	1.595E+09
4	0.000	2.320	0.090	2	45.00	162000	0.0000000	0.0000143	0.0000006	0.0000018	6.217E-10	1.608E+09
5	0.000	2.880	0.130	2	55.00	198000	0.0000000	0.0000145	0.0000007	0.0000019	5.991E-10	1.669E+09
6	0.000	2.370	-0.270	2	44.50	160200	0.0000000	0.0000148	-0.0000017	0.0000021	6.63E-10	1.508E+09
7	0.000	2.935	6.090	2	48.33	174000	0.0000000	0.0000169	0.0000350	0.0000021	6.63E-10	1.508E+09
8	0.000	0.000	-2.185	3	46.00	165600	0.0000000	0.0000000	-0.0000132	0.0000000	0	-
Average											1.577E+09	

Material P8
 Modified inverted cup method (MIC)
 August 3rd 2002 - Beginning of test
 Temperature control: +/- 1.5 °C

Area of specimen: 0.00793 sq.m.

Thickness of Dupont tyvek commercial wrap

Sample Layer	Point 1	Point 2	Point 3	Point 4	Average thickness per layer
1	0.21	0.17	0.19	0.19	0.19
2	0.15	0.18	0.15	0.18	0.165
3	0.18	0.17	0.19	0.17	0.1775
					Thickness 0.533

Weight of paper in grammes
 8-C 2.82

Table 1.: Recordings of weights for 8-C

Sr. No.	Date	Time		Weights (1)				Temp. °C	Relative Humidity %	Pressure difference Δ P
		Dry Cup	Hours	Wt. Of liquid Cup	New wt. Of Dry Cup	Wt. Of Ring + Specimen				
1	03/08/2002	11:40	0.00	0.000	N/A	436.440	109.310	23.9	51.0	2968
2	05/08/2002	15:10	51.50	0.000	422.010	438.761	109.294	23.3	53.0	2863
3	07/08/2002	15:40	48.50	0.000	431.490	424.900	115.250	23.5	44.0	2898
4	09/08/2002	12:10	45.00	0.000	434.200	443.960	112.260	23.1	47.0	2880
5	11/08/2002	19:10	55.00	0.000	435.150	442.420	110.920	23.8	49.0	2950
6	13/08/2002	16:10	45.00	0.000	434.240	437.470	111.740	24.7	55.6	3114
7	15/08/2002	16:00	47.83	0.000	430.860	451.460	113.510	25.8	55.4	3208
8	17/08/2002	15:00	46.00	0.000	N/A	Leakage	119.530	24.8	49.0	3132

Table 2.: Water Vapour Transmission through material in 8-C

Sr. No.	Weight change in cups		Time		Weight change per unit time		q/A		Permeance		Resistance	
	Water Cup	Dry Cup	Days	Hours	Seconds	dW/dt	dDes/dt (g/s)	dSp/dt (s m ² /kg)	Solution Side	Desiccant Side	Solution Side	Desiccant Side
1	0.000	0.000	0	0.00	0	0.0000000	0.0000125	-0.0000001			5.514E-10	1.81E+09
2	0.000	2.321	2	51.50	185400	0.0000000	0.0000166	0.0000021			7.203E-10	1.39E+09
3	0.000	2.890	2	48.50	174600	0.0000000	0.0000070	-0.0000185			3.37E-09	2.97E+08
4	0.000	12.470	2	45.00	162000	0.0000000	0.0000415	-0.0000068			1.774E-09	5.64E+08
5	0.000	8.220	2	55.00	198000	0.0000000	0.0000143	0.0000051			5.799E-10	1.72E+09
6	0.000	2.320	2	45.00	162000	0.0000000	0.0001000	0.0000103			3.931E-09	2.54E+08
7	0.000	17.220	2	47.83	172200	0.0000000	0.0000000	0.0000364				
8	0.000	0.000	3	46.00	165600	0.0000000	0.0000000	0.0000000				
												Average 1.007E+09

Material P8
 Modified inverted cup method (MIC)
 August 3rd 2002 - Beginning of test
 Temperature control: ± 1.5 °C

Area of specimen: 0.00793 sq. m.

Thickness of Dupont tyvek commercial wrap

Sample 8-D Layer	Point 1	Point 2	Point 3	Point 4	Average thickness per layer
1	0.21	0.22	0.15	0.19	0.1925
2	0.18	0.16	0.19	0.18	0.1775
3	0.15	0.16	0.16	0.19	0.165
4	0.19	0.17	0.16	0.16	0.17
Average thickness					0.176

Weight of paper in grammes

8-D 3.78

Table 1: Recordings of weights for 8-D

Sr. No.	Date		Time		Weights (g)			Temp. °C	Relative Humidity %	Pressure difference Δ P
	Time	Hours	Wt. Of liquid Cup	New wt. Of Dry Cup	Wt. Of Dry Cup	Wt. Of Ring + Specimen	Temp. °C			
1	03/08/2002	11:45	0.00	N/A	432.970	113.980	23.9	51.0	2968	
2	05/08/2002	15:15	51.50	434.460	434.675	113.958	23.3	53.0	2863	
3	07/08/2002	15:45	48.50	431.680	436.080	113.990	23.5	44.0	2898	
4	09/08/2002	12:15	44.50	432.060	433.420	117.130	23.1	47.0	2880	
5	11/08/2002	19:15	55.00	432.370	434.800	119.310	23.8	49.0	2950	
6	13/08/2002	16:15	45.00	433.250	435.030	120.190	24.7	55.6	3114	
7	15/08/2002	16:00	47.75	430.880	451.060	120.600	25.8	55.4	3208	
8	17/08/2002	15:00	46.00	N/A	Leakage	112.260	24.8	49.0	3132	

Table 2: Water Vapour Transmission through material in 8-D

Sr. No.	Weight change in cups			Time			Weight change per unit time				Permeance		Resistance		
	Water Cup	Dry Cup	Specimen	Days	Hours	Seconds	dW/dt	dDes/dt (g/s)	dSp/dt	Solution Side	Desiccant Side	Solution Side	Desiccant Side	Solution Side	Desiccant Side
1	0.000	0.000	0.000	0	0.00	0	0.0000000	0.0000092	-0.0000001	0.0000012	0.0000012	4.051E-10	4.051E-10	2.469E+09	2.469E+09
2	0.000	1.705	-0.022	2	51.50	185400	0.0000000	0.0000093	0.0000002	0.0000012	0.0000012	4.038E-10	4.038E-10	2.477E+09	2.477E+09
3	0.000	1.620	0.032	2	48.50	174600	0.0000000	0.000109	0.0000196	0.0000014	0.0000014	4.755E-10	4.755E-10	2.103E+09	2.103E+09
4	0.000	1.740	3.140	2	44.50	160200	0.0000000	0.0000138	0.0000110	0.0000017	0.0000017	5.915E-10	5.915E-10	1.691E+09	1.691E+09
5	0.000	2.740	2.180	2	55.00	198000	0.0000000	0.000164	0.0000054	0.0000021	0.0000021	6.649E-10	6.649E-10	1.504E+09	1.504E+09
6	0.000	2.660	0.880	2	45.00	162000	0.0000000	0.0001036	0.0000024	0.00000131	0.00000131	4.073E-09	4.073E-09	245546101	245546101
7	0.000	17.810	0.410	2	47.75	171900	0.0000000	0.0000000	-0.0000054	0.0000000	0.0000000	0	0	-	-
8	0.000	0.000	-8.340	3	46.00	165600	0.0000000	0.0000000	-0.0000000	0.0000000	0.0000000	0	0	-	-
Average															1.748E+09

Material C4
Modified inverted cup (MIC)
Temperature control: $\pm 1.0^{\circ}\text{C}$

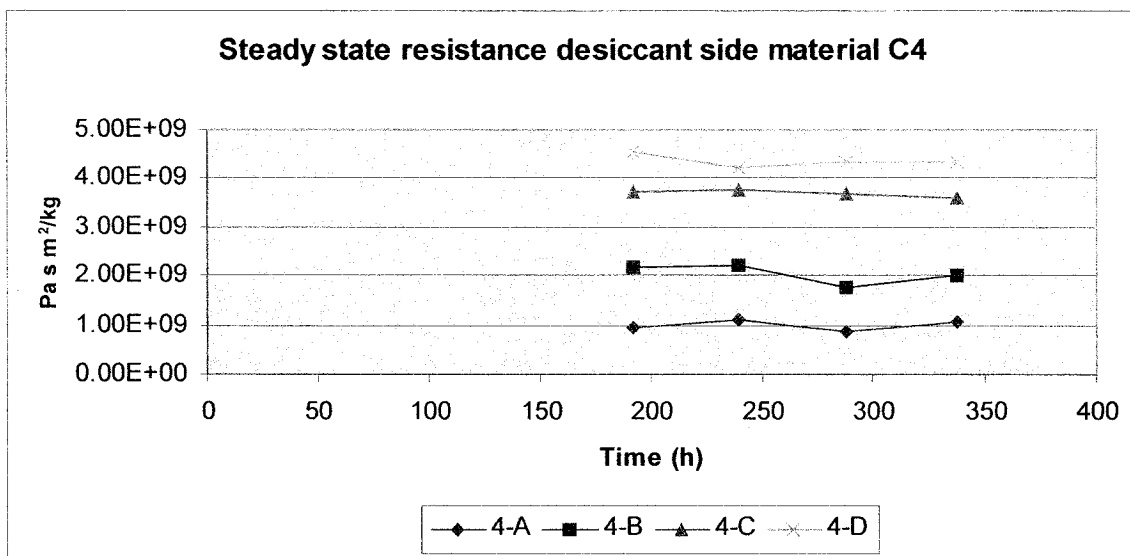
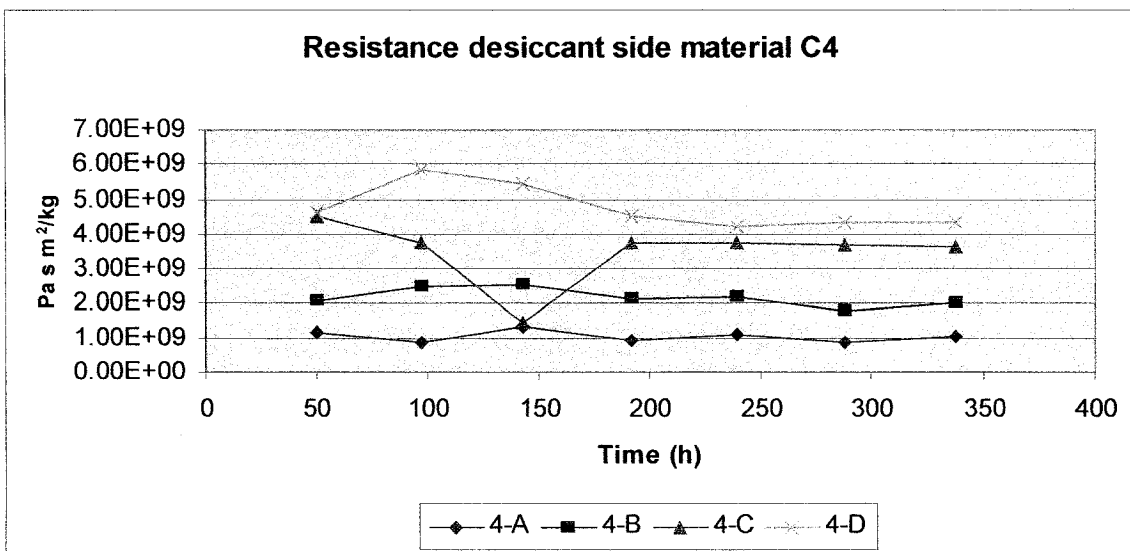

Steady state resistance desiccant side material C4

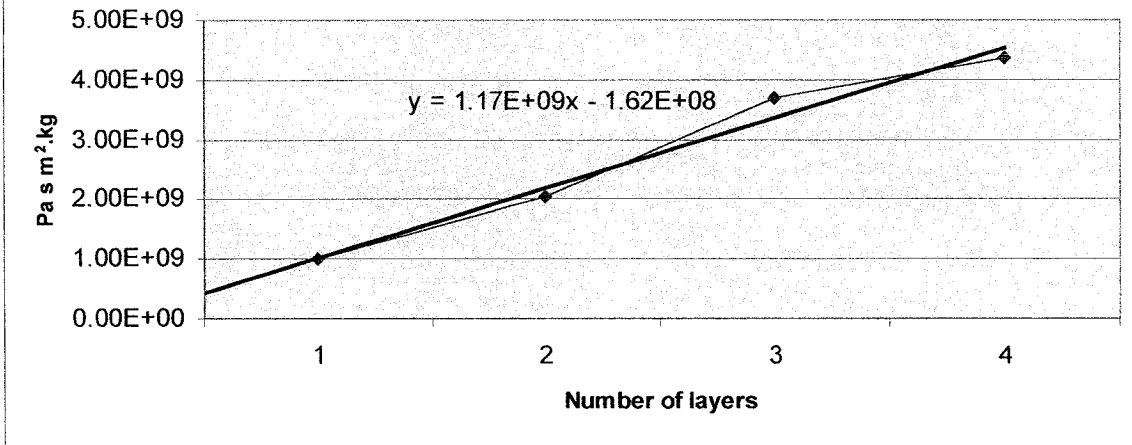

Material C4
 Modified inverted cup method (MIC)
 Liquid cup: Water 100%
 August 3rd 2002 - Beginning of test
 Temperature control: +- 1.0 °C

Area of specimen: 0.00793

Thickness of material 4 in mm

Sample Layer all Point 1 0.33 Point 2 0.33 Point 3 0.3 Point 4 0.34 Averagethickness 0.325

Weight of paper in grammes
 4-A 3.171

Table 1.: Recordings of weights for 4-A

Sr. No.	Time		Hours	Weights (g)			Temp. °C	Relative Humidity %	Pressure difference ΔP
	Date	Time		Wt. Of liquid Cup	New wt. Of Dry Cup	Wt. Of Ring + Specimen			
1	18/10/2002	16:30	0.00	0.000	N/A	242.859	23.5	25.3	2880
2	20/10/2002	19:15	50.75	0.000	246.155	245.805	22.5	24.5	2339
3	22/10/2002	17:45	46.50	0.000	243.808	250.213	21.6	21.1	2632
4	24/10/2002	16:00	46.25	0.000	243.944	246.657	23.0	20.1	2811
5	26/10/2002	16:00	48.00	0.000	244.227	247.436	22.9	30.1	2396
6	28/10/2002	15:30	48.50	0.000	243.984	247.176	22.9	22.4	2396
7	30/10/2002	16:00	48.50	0.000	243.114	247.698	22.4	19.9	2325
8	01/11/2002	17:00	49.00	0.000	N/A	246.177	22.5	22.0	2339

Daylight savings time one hour added

Table 2.: Water Vapour Transmission through material in 4-A

Sr. No.	Weight change in cups		Specimen Cup	Time		Days		Hours		Seconds		Weight change per unit time		q/A		Permeance		Resistance	
	Water Cup	Dry Cup		Days	Hours	Seconds	dW/dt	dDes/dt (g/s)	dSp/dt	Solution Side	Desiccant Side	(Pa s ² /kg)	Desiccant side	Solution Side	Desiccant side	(Pa s ² /kg)	Solution Side	Desiccant side	
1	0.000	0.000	0.000	0.00	0	0	0.000161	0.0000034	0	0.0000020	0	8.693E-10	0	1.15E+09	0	1.15E+09	0	1.15E+09	
2	0.946	2.946	0.621	50.75	182700	2	0.000242	-0.0000004	0	0.0000031	0	1.162E-09	0	8.61E+08	0	8.61E+08	0	8.61E+08	
3	0.000	4.058	-0.063	46.50	167400	2	0.000171	0.0000000	0	0.0000022	0	7.678E-10	0	1.30E+09	0	1.30E+09	0	1.30E+09	
4	0.000	2.849	-0.003	46.25	166500	2	0.000202	-0.0000002	0	0.0000025	0	1.063E-09	0	9.40E+08	0	9.40E+08	0	9.40E+08	
5	0.000	3.492	-0.026	48.00	172800	2	0.000169	0.0000007	0	0.0000021	0	8.889E-10	0	1.3E+09	0	1.3E+09	0	1.3E+09	
6	0.000	2.949	0.118	48.50	174600	2	0.000213	0.0000005	0	0.0000027	0	1.154E-09	0	8.67E+08	0	8.67E+08	0	8.67E+08	
7	0.000	3.714	0.080	48.50	174600	2	0.000174	0.0000004	0	0.0000022	0	9.361E-10	0	1.07E+09	0	1.07E+09	0	1.07E+09	
8	0.000	3.063	0.070	49.00	176400	2			0					Average		1.045E+09		1.045E+09	
																Steady state average		1.00E+09	

Material C4
 Modified inverted cup method (MIC)
 Liquid cup: Water 100%
 August 3rd 2002 - Beginning of test
 Temperature control: +/- 1.0 °C

Area of specimen: 0.00793 sq.m.

Thickness of material 4 in mm

Sample Layer all Point 1 0.66 Point 2 0.66 Point 3 0.67 Point 4 0.65 Averagethickness 0.660

Weight of paper in grammes
 4-B 6.14

Table 1: Recordings of weights for 4-B

Sr. No.	Date		Time		Hours		Wt. Of liquid		Weights (1)		Temp.		Relative Humidity %	Pressure difference Δ P
	Water Cup	Dry Cup	Time	Specimen Cup	Wt. Of Dry Cup	Wt. Of Ring + Specimen Cup	Temp. °C	Relative Humidity %	Wt. Of liquid Cup	New wt. Of Dry Cup	Wt. Of Ring + Specimen Cup	Temp. °C		
1	0.900	0.000	16:34	0.000	0.000	0.000	0.000	0.000	244.912	121.719	23.5	25.3	2880	
2	0.900	1.610	19:19	0.000	50.75	244.364	246.522	22.5	24.5	2339				
3	0.900	1.392	17:48	0.000	46.50	243.317	245.756	21.6	21.1	2632				
4	0.900	1.465	16:04	0.000	46.25	242.036	244.782	23.0	20.1	2811				
5	0.900	1.524	16:04	0.000	48.00	243.143	243.560	22.9	30.1	2396				
6	0.900	1.816	15:34	0.000	48.50	242.469	244.649	22.4	22.4	2396				
7	0.900	1.506	16:04	0.000	48.50	244.432	244.285	22.4	19.9	2325				
8	0.900	1.629	17:04	0.000	49.00	246.061	246.061	22.5	22.0	2339				

Daylight savings time one hour added

Table 2: Water Vapour Transmission through material in 4-B

Sr. No.	Weight change in cups		Specimen		Time		Weight change per unit time		q/A		Permeance		Resistance	
	Water Cup	Dry Cup	Days	Hours	Seconds	dW/dt	dDes/dt (g/s)	dSp/dt	Solution Side	Desiccant Side	Solution Side	Desiccant Side	Solution Side	Desiccant Side
1	0.900	0.000	0	0.00	0	0.000000	0.000000	0.000000	0.000000	0.000000	0.000000	0.000000	0.000000	0.000000
2	0.900	1.610	2	50.75	182700	0.000008	0.0000047	0.0000047	0.0000011	0.0000011	4.751E-10	2.105E+09	0.0000011	2.105E+09
3	0.900	1.392	2	46.50	167400	0.0000083	0.0000007	0.0000007	0.0000010	0.0000010	3.984E-10	2.51E+09	0.0000010	2.51E+09
4	0.900	1.465	2	46.25	166500	0.0000088	0.0000007	0.0000007	0.0000011	0.0000011	3.948E-10	2.533E+09	0.0000011	2.533E+09
5	0.900	1.524	2	48.00	172800	0.0000088	-0.0000004	0.0000004	0.0000011	0.0000011	4.641E-10	2.165E+09	0.0000011	2.165E+09
6	0.900	1.816	2	48.50	174600	0.0000086	0.0000005	0.0000005	0.0000011	0.0000011	4.539E-10	2.203E+09	0.0000011	2.203E+09
7	0.900	1.506	2	48.50	174600	0.0000104	0.0000044	0.0000044	0.0000013	0.0000013	5.642E-10	1.773E+09	0.0000013	1.773E+09
8	0.900	1.629	2	49.00	176400	0.0000092	0.0000008	0.0000008	0.0000012	0.0000012	4.978E-10	2.009E+09	0.0000012	2.009E+09
Average														2.181E+09
Steady state average														2.036E+09

Material C4
 Modified inverted cup method (MIC)
 Liquid cup: Water 100%
 August 3rd 2002 - Beginning of test
 Temperature control: +- 1.0 °C

Area of specimen: 0.00793 sq.m.

Thickness of material 4 in mm

Sample Layer all Point 1 1.01 Point 2 1.01 Point 3 1.02 Point 4 1.04 Averagethickness 1.020

Weight of paper in grammes
 4-C 9.872

Table 1: Recordings of weights for 4-C

Sr. No.	Time		Hours	Weights (1)		Temp. °C	Relative Humidity %	Pressure difference Δ P
	Date	Time		Wt. Of liquid Cup	New wt. Of Dry Cup			
1	18/10/2002	16:38	0.00	0.000	N/A	260.250	25.3	2880
2	20/10/2002	19:23	50.75	0.000	261.075	261.000	24.5	2339
3	22/10/2002	17:52	46.50	0.000	260.827	262.000	21.1	2632
4	24/10/2002	16:08	46.25	0.000	259.405	263.427	20.1	2811
5	26/10/2002	16:08	48.00	0.000	260.056	260.283	30.1	2396
6	28/10/2002	15:38	48.50	0.000	260.130	260.940	22.9	2396
7	30/10/2002	16:08	48.50	0.000	259.328	261.001	22.4	2325
8	01/11/2002	17:08	49.00	0.000	N/A	260.232	22.0	2339

Daylight savings time: one hour added

Table 2: Water Vapour Transmission through material in 4-C

Sr. No.	Weight change in cups			Time			Weight change per unit time		q/A		Permeance		Resistance		
	Water Cup	Dry Cup	Specimen Cup	Days	Hours	Seconds	dW/dt	dDes/dt (g/s)	aSp/dt	Solution Side	Desiccant Side	Solution Side	Desiccant Side	Solution Side	Desiccant Side
1	0.000	0.000	0.000	0	0.00	0	0	0.0000041	0.0000072	0	0.0000005	0	0.0000000	0	4.519E+09
2	0.900	0.750	1.307	2	50.75	182700	0	0.0000055	-0.0000001	0	0.0000007	0	0.0000000	0	2.213E-10
3	0.900	0.925	-0.014	2	46.50	167400	0	0.0000156	0.0000007	0	0.0000020	0	0.0000000	0	2.648E-10
4	0.900	2.600	0.12	2	46.25	168500	0	0.0000051	-0.0000005	0	0.0000006	0	0.0000000	0	7.007E-10
5	0.900	0.878	-0.09	2	48.00	172800	0	0.0000051	0.0000012	0	0.0000006	0	0.0000000	0	2.674E-10
6	0.900	0.884	0.213	2	48.50	174600	0	0.0000050	0.0000001	0	0.0000006	0	0.0000000	0	2.664E-10
7	0.900	0.871	0.011	2	48.50	174600	0	0.0000050	0.0000001	0	0.0000006	0	0.0000000	0	2.706E-10
8	0.900	0.904	0.033	2	49.00	178400	0	0.0000051	0.0000002	0	0.0000006	0	0.0000000	0	2.763E-10
Average														3.504E+09	
Steady state average														3.702E+09	

Material C4
 Modified inverted cup method (MIC)
 Liquid cup: Water 100%
 August 3rd 2002 - Beginning of test
 Temperature control: +/- 1.0 °C

Area of specimen: 0.00793 sq. m.

Thickness of material 4 in mm

Sample Layer all Point 1 1.35 Point 2 1.34 Point 3 1.34 Point 4 1.35 Averagethickness 1.345

Weight of paper in grammes
 4-D 12.967

Table 1: Recordings of weights for 4-D

Sr. No.	Time		Hours	Weights (1)		Temp. °C	Relative Humidity %	Pressure difference Δ P
	Date	Time		Wt. Of liquid Cup	Wt. Of Dry Cup			
1	18/10/2002	16:42	0.00	N/A	245.239	23.5	25.3	2880
2	20/10/2002	19:27	50.75	0.000	245.500	22.5	24.5	2339
3	22/10/2002	17:56	46.50	0.000	244.305	21.6	21.1	2632
4	24/10/2002	16:12	46.25	0.000	244.299	23.0	20.1	2811
5	26/10/2002	16:12	48.00	0.000	244.366	22.9	30.1	2396
6	28/10/2002	15:42	48.50	0.000	245.060	22.9	22.4	2396
7	30/10/2002	16:12	48.50	0.000	244.472	22.4	19.9	2325
8	01/11/2002	17:12	49.00	0.000	245.227	22.5	22.0	2339

Daylight savings time, one hour added

Table 2: Water Vapour Transmission through material in 4-D

Sr. No.	Weight change in cups			Time		Weight change per unit time		q/A		Permeance		Resistance	
	Water Cup	Dry Cup	Specimen Cup	Days	Hours	Seconds	dW/dt	dDes/dt (g/s)	dSp/dt	Solution Side	Desiccant Side	Solution Side	Desiccant Side
1	0.000	0.000	0.000	0	0.00	0	0	0.0000040	0.0000055	0	0.0000005	0	0.0000005
2	0.000	0.732	1.003	2	50.75	182700	0	0.0000036	0.0000009	0	0.0000004	0	2.1599E-10
3	0.000	0.596	0.152	2	46.50	167400	0	0.0000041	0.0000010	0	0.0000005	0	1.7059E-10
4	0.000	0.682	0.173	2	46.25	166500	0	0.0000042	-0.0000001	0	0.0000005	0	1.8379E-10
5	0.000	0.725	-0.016	2	48.00	172800	0	0.0000045	0.0000002	0	0.0000006	0	2.208E-10
6	0.000	0.783	0.043	2	48.50	174600	0	0.0000042	0.0000004	0	0.0000005	0	2.36E-10
7	0.000	0.742	0.070	2	48.50	174600	0	0.0000043	0.0000005	0	0.0000005	0	2.3051E-10
8	0.000	0.755	0.095	2	49.00	176400	0	0.0000043	0.0000005	0	0.0000005	0	2.3074E-10
Average													4.767E+09
Steady state average													4.36E+09

Material C4
Modified inverted cup (MIC)
Temperature control: $\pm 1.5^\circ\text{C}$

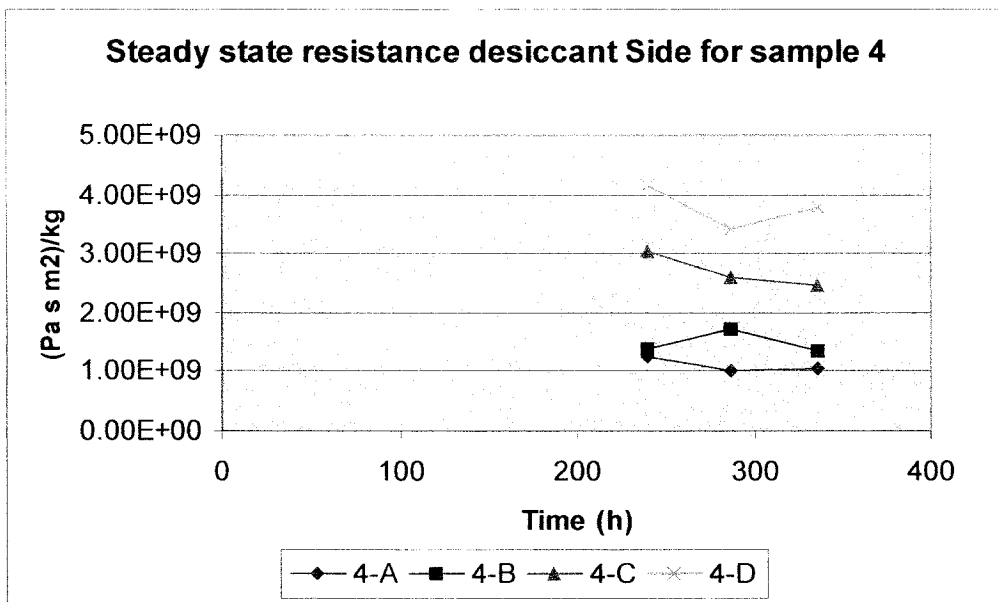
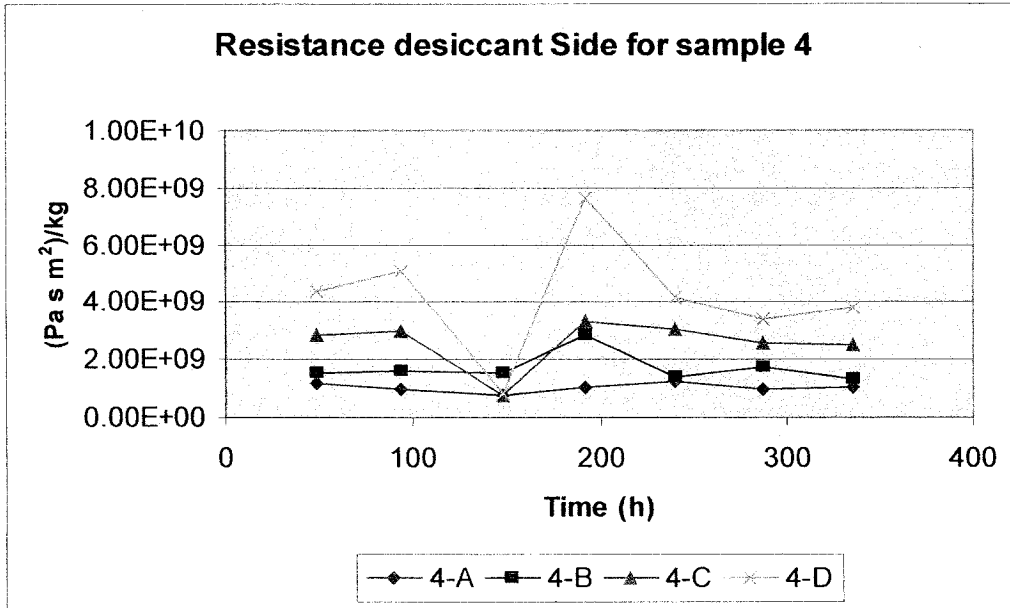

Steady state resistance intercept values for sample 4

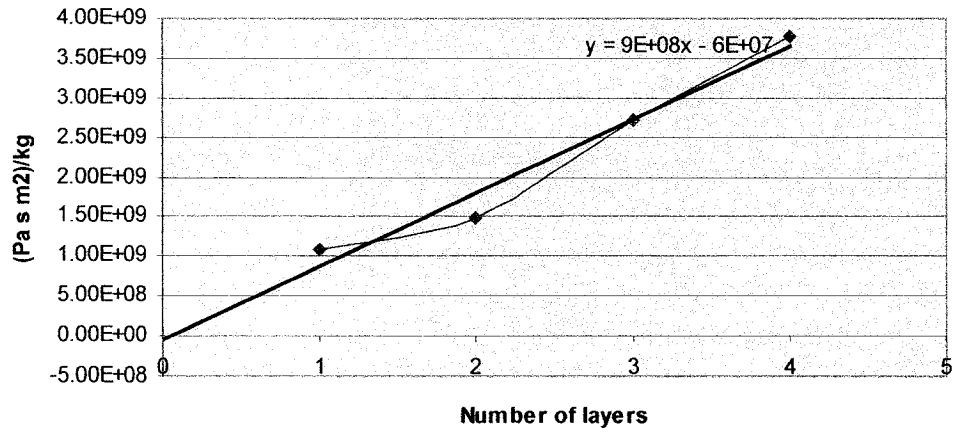

Material C4
 Modified inverted cup method (MIC)
 August 3rd 2002 - Beginning of test
 Temperature control: +- 1.5 °C

Area of specimen: 0.00793

Thickness of material C4 in mm
 Sample Layer Point 1 Point 2 Point 3 Point 4
 4-A 1 0.34 0.35 0.33 0.33 0.338

Weight of paper in grammes
 4-A 3.05

Table 1: Recordings of weights for 4-A

Sr. No.	Time		Hours	Weights (1)		Temp. °C	Relative Humidity %	Pressure difference Δ.P
	Date	Time		Wt. Of liquid Cup	New wt. Of Dry Cup + Wt. Of Ring + Specimen			
1	05/08/2002	15:30	0.00	0.000	218.739	23.9	53.0	2853
2	07/08/2002	16:00	48:50	0.000	220.580	23.3	44.0	2898
3	09/08/2002	13:00	45:00	0.000	221.600	23.5	47.0	2880
4	11/08/2002	19:30	54:50	0.000	214.390	23.1	49.0	2950
5	13/08/2002	15:30	44:00	0.000	220.860	23.8	55.6	3114
6	15/08/2002	15:30	48:00	0.000	217.740	24.7	55.4	3208
7	17/08/2002	14:30	47:00	0.000	218.020	25.8	49.0	3132
8	19/08/2002	15:00	48:50	0.000	222.040	24.8	44.0	3022

Table 2: Water Vapour Transmission through material in 4-A

Sr. No.	Weight change in cups		Time		Weight change per unit time		g/A		Permeance		Resistance	
	Water Cup	Dry Cup	Days	Hours	dW/dt	dDes/dt (g/s)	Solution Side	Desiccant Side	Solution Side	Desiccant Side	Solution Side	Desiccant Side
1	0.900	0.000	0	0:00	0.0000000	0.0000000	0.0000025	0.0000030	8.638E-10	8.638E-10	1.16E+09	1.16E+09
2	0.900	3.466	2	48:50	0.0000000	0.0000199	0.0000030	0.0000030	1.04E-09	1.04E-09	9.61E+08	9.61E+08
3	0.900	3.850	2	45:00	0.0000000	0.0000238	0.0000038	0.0000038	1.292E-09	1.292E-09	7.74E+08	7.74E+08
4	0.900	5.930	2	54:50	0.0000000	0.0000302	0.0000031	0.0000031	9.894E-10	9.894E-10	1.01E+09	1.01E+09
5	0.900	3.870	2	44:00	0.0000000	0.0000244	0.0000026	0.0000026	8.078E-10	8.078E-10	1.24E+09	1.24E+09
6	0.900	3.550	2	48:00	0.0000000	0.0000205	0.0000031	0.0000031	1.002E-09	1.002E-09	9.98E+08	9.98E+08
7	0.900	4.210	2	47:00	0.0000000	0.0000249	0.0000029	0.0000029	9.608E-10	9.608E-10	1.04E+09	1.04E+09
8	0.900	4.020	2	48:50	0.0000000	0.0000230	0.0000029	0.0000029	9.608E-10	9.608E-10	1.03E+09	1.03E+09
Average											1.03E+09	1.03E+09
S.S. Average											1.03E+09	1.03E+09

Material C4
 Modified inverted cup method (MIC)
 August 3rd 2002 - Beginning of test
 Temperature control: +- 1.5 °C

Area of specimen: 0.00793 sq.m.

Thickness of material C4 in mm
 Sample Layer Point 1 Point 2 Point 3 Point 4 Averagethickness
 4-B 1 0.35 0.32 0.33 0.34 0.335
 2 0.34 0.34 0.32 0.33 0.333
 0.334

Weight of paper in grammes
 4-B 6.14

Table 1.: Recordings of weights for 4-B

Sr. No.	Time		Weights (1)				Temp. °C	Relative Humidity %	Pressure difference Δ P
	Date	Time	Hours	Wt. Of liquid Cup	New wt. Of Dry Cup	Wt. Of Ring + Specimen			
1	03/08/2002	12:10	0.00	0.000	N/A	430.750	23.9	51.0	2968
2	05/08/2002	15:40	51.50	0.000	430.725	433.539	23.3	53.0	2863
3	07/08/2002	16:10	48.50	0.000	431.300	433.185	23.5	44.0	2898
4	09/08/2002	13:10	45.00	0.000	429.260	433.770	23.1	47.0	2880
5	11/08/2002	19:40	54.50	0.000	426.440	430.880	23.8	49.0	2950
6	13/08/2002	15:40	44.00	0.000	431.230	429.260	24.7	55.6	3114
7	15/08/2002	15:40	48.00	0.000	428.165	433.780	25.8	55.4	3208
8	17/08/2002	14:40	46.00	0.000	N/A	431.225	24.8	49.0	3132

Table 2.: Water Vapour Transmission through material in 4-B

Sr. No.	Weight change in cups		Time			Weight change per unit time			g/A		Permeance		Resistance		
	Water Cup	Dry Cup	Specimen	Days	Hours	Seconds	dW/dt	dDes/dt (g/s)	dSp/dt	Solution Side	Desiccant Side	Solution Side	Desiccant Side	Solution Side	Desiccant Side
1	0.000	0.000	0.000	0	0.00	0	0.0000000	0.0000150	0.0000072						
2	0.000	2.789	1.336	2	51.50	185400	0.0000000	0.0000141	-0.0000008						
3	0.000	2.460	-0.136	2	48.50	174600	0.0000000	0.0000152	0.0000043						
4	0.000	2.470	0.690	2	45.00	162000	0.0000000	0.0000083	-0.0000243						
5	0.000	1.620	-4.770	2	54.50	196200	0.0000000	0.000178	0.0000280						
6	0.000	2.820	4.440	2	44.00	158400	0.0000000	0.0000148	0.0000000						
7	0.000	2.550	0.000	2	48.00	172800	0.0000000	0.0000185	0.0000005						
8	0.000	3.060	0.080	2	46.00	165600	0.0000000	0.0000000	0.0000000						
										Average					
										S.S. Average					

Material C4
 Modified inverted cup method (MIC)
 August 3rd 2002 - Beginning of test
 Temperature control: + - 1.5 °C

Area of specimen: 0.00793 sq.m.

Thickness of material C4 in mm

Sample Layer	Point 1	Point 2	Point 3	Point 4	Average thickness
1	0.33	0.34	0.34	0.33	0.335
2	0.34	0.33	0.33	0.34	0.335
3	0.34	0.34	0.35	0.34	0.343
					0.338

Weight of paper in grammes
 4-C 9.62

Table 1: Recordings of weights for 4-C

Sr. No.	Date	Time		Wt. Of liquid Cup	Weights (1)		Temp. °C	Barometric Pressure	Relative Humidity %	Pressure difference Δ P	
		Time	Hours		New wt. Of Dry Cup	Wt. Of Dry Specimen				Solution Side	Desiccant Side
1	05/08/2002	15:30	0.00	0.000	284.163	119.280	23.9	0	53.0	2863	2863
2	07/08/2002	16:00	48.50	0.000	279.315	285.605	23.3	0	44.0	2968	2968
3	09/08/2002	13:00	45.00	0.000	278.540	280.550	23.5	0	47.0	2880	2880
4	11/08/2002	19:30	54.50	0.000	275.000	284.490	23.1	0	49.0	2950	2950
5	13/08/2002	15:30	44.00	0.000	277.680	276.180	23.8	0	55.6	3114	3114
6	15/08/2002	15:35	48.08	0.000	279.660	279.125	24.7	0	55.4	3208	3208
7	17/08/2002	14:35	47.00	0.000	278.960	281.280	25.8	0	49.0	3132	3132
8	19/08/2002	15:05	48.50	0.000	N/A	280.650	24.8	0	44.0	3022	3022

Table 2: Water Vapour Transmission through material in 4-C

Sr. No.	Weight change in cups		Time		Weight change per unit time		q/A		Permeance		Resistance		
	Water Cup	Dry Cup	Specimen	Days	Hours	Seconds	dW/dt	dDes/dt	dSp/dt	Solution Side	Desiccant Side	Solution Side	Desiccant Side
1	0.000	0.000	0.000	0	0.00	0	0.0000000	0.0000083	0.0000028	0.0000010	0.0000010	3.509E-10	2.85E+09
2	0.000	1.442	0.490	2	48.50	174600	0.0000000	0.0000076	0.0000017	0.0000010	0.0000010	3.338E-10	3.00E+09
3	0.000	1.235	0.270	2	45.00	162000	0.0000000	0.0000303	-0.0000191	0.0000038	0.0000038	1.298E-09	7.71E+08
4	0.000	5.950	-3.750	2	54.50	196200	0.0000000	0.0000074	0.0000234	0.0000009	0.0000009	3.017E-10	3.31E+09
5	0.000	1.180	3.700	2	44.00	158400	0.0000000	0.0000083	0.0000002	0.0000011	0.0000011	3.281E-10	3.05E+09
6	0.000	1.445	0.030	2	48.08	173100	0.0000000	0.0000096	-0.0000002	0.0000012	0.0000012	3.854E-10	2.59E+09
7	0.000	1.620	-0.030	2	47.00	169200	0.0000000	0.0000097	0.0000005	0.0000012	0.0000012	4.039E-10	2.48E+09
8	0.000	1.690	0.090	2	48.50	174600	0.0000000	0.0000097	0.0000005	0.0000012	0.0000012	4.039E-10	2.48E+09
											Average	2.71E+09	
											S.S. Average	2.71E+09	

Material C4

Modified inverted cup method (MIC)
August 3rd 2002 - Beginning of test
Temperature control: +/- 1.5 °C

Area of specimen: 0.00793 sq.m.

Thickness of material C4 in mm

Sample 4-D	Layer	Point 1	Point 2	Point 3	Point 4	Average thickness
1		0.33	0.34	0.34	0.34	0.338
2		0.33	0.34	0.34	0.34	0.338
3		0.35	0.33	0.34	0.34	0.340
4		0.34	0.33	0.34	0.34	0.338
						0.338

Weight of paper in grammes

4-D 13.11

Table 1.: Recordings of weights for 4-D

Sr. No.	Date	Time	Hours	Weights (1)		Temp. °C	Relative Humidity %	Pressure difference Δ P
				Wt. Of liquid Cup	New wt. Of Dry Cup			
1	05/08/2002	15:45	0.00	0.000	N/A	23.9	53.0	2863
2	07/08/2002	16:15	48.50	0.000	283.665	23.3	44.0	2898
3	09/08/2002	13:15	45.00	0.000	280.750	23.5	47.0	2880
4	11/08/2002	19:45	54.50	0.000	276.940	23.1	49.0	2950
5	13/08/2002	15:45	44.00	0.000	281.650	23.8	55.6	3114
6	15/08/2002	15:35	47.83	0.000	281.460	24.7	55.4	3208
7	17/08/2002	14:35	47.00	0.000	281.010	25.8	49.0	3132
8	19/08/2002	15:05	48.50	0.000	282.115	24.8	44.0	3022

Table 2.: Water Vapour Transmission through material in 4-D

Sr. No.	Weight change in cups		Time		Weight change per unit time		q/A		Permeance		Resistance		
	Water Cup	Dry Cup	Days	Hours	dW/dt	dDes/dt	dSp/dt	Solution Side	Desiccant Side	Solution Side	Desiccant Side	Solution Side	Desiccant Side
1	0.000	0.000	0	0.00	0	0	0.0000000	0.0000000	0.0000000	0.0000000	0.0000000	2.271E-10	4.40E+09
2	0.000	0.911	2	48.50	174600	0.0000052	0.0000032	0.0000006	0.0000006	0.0000006	0.0000006	1.959E-10	5.10E+09
3	0.000	0.725	2	45.00	162000	0.0000045	0.0000009	0.0000009	0.0000009	0.0000009	0.0000009	1.181E-09	8.47E+08
4	0.000	5.420	2	54.50	196200	0.0000276	-0.0000189	0.0000035	0.0000035	0.0000035	0.0000035	1.304E-10	7.67E+09
5	0.000	0.510	2	44.00	158400	0.0000032	0.0000245	0.0000004	0.0000004	0.0000004	0.0000004	2.408E-10	4.15E+08
6	0.000	1.055	2	47.83	172200	0.0000061	-0.0000003	0.0000003	0.0000003	0.0000003	0.0000003	2.938E-10	3.40E+09
7	0.000	1.235	2	47.00	169200	0.0000073	0.0000001	0.0000001	0.0000001	0.0000001	0.0000001	2.641E-10	3.79E+09
8	0.000	1.105	2	48.50	174600	0.0000063	0.0000005	0.0000005	0.0000005	0.0000005	0.0000005	2.641E-10	4.20E+09
											Average	4.20E+09	
											S.S.Average	3.78E+09	

Material C5
Modified inverted cup (MIC)
Temperature control: $\pm 1.0^{\circ}\text{C}$

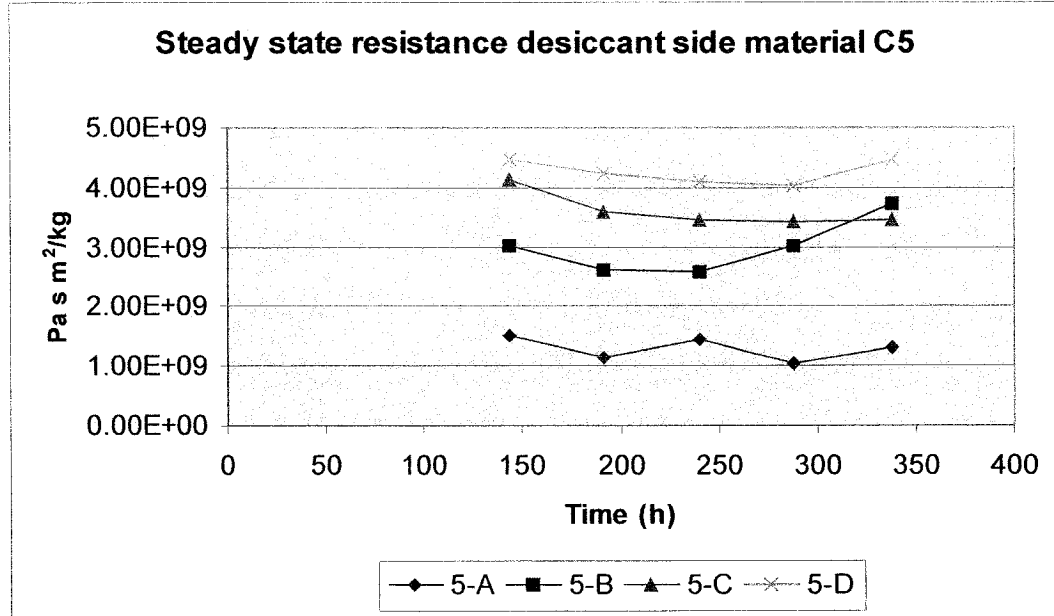
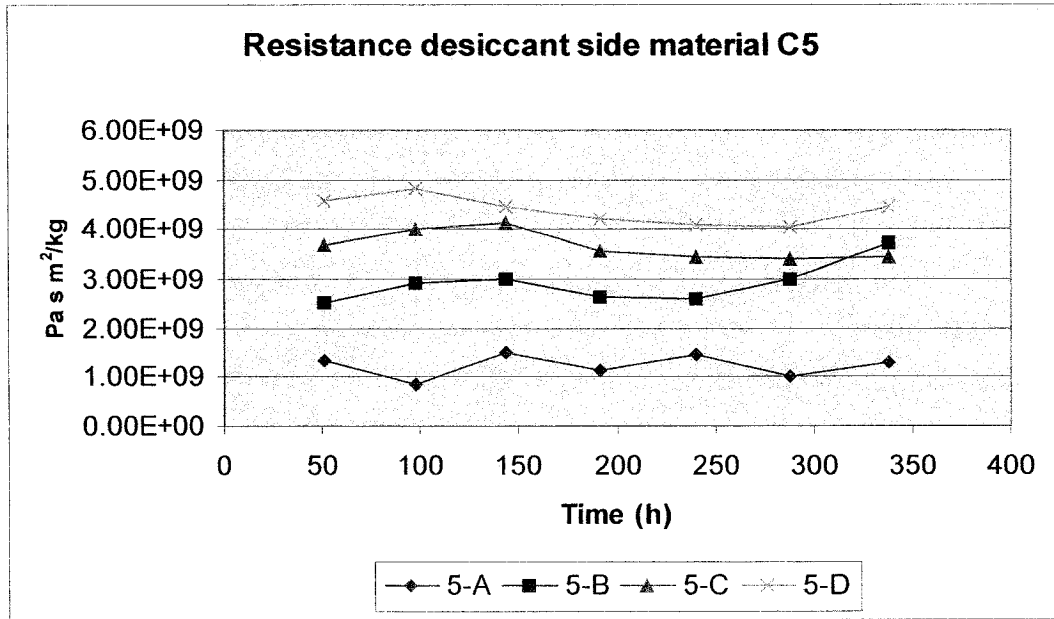

Steady state resistance desiccant side material C5

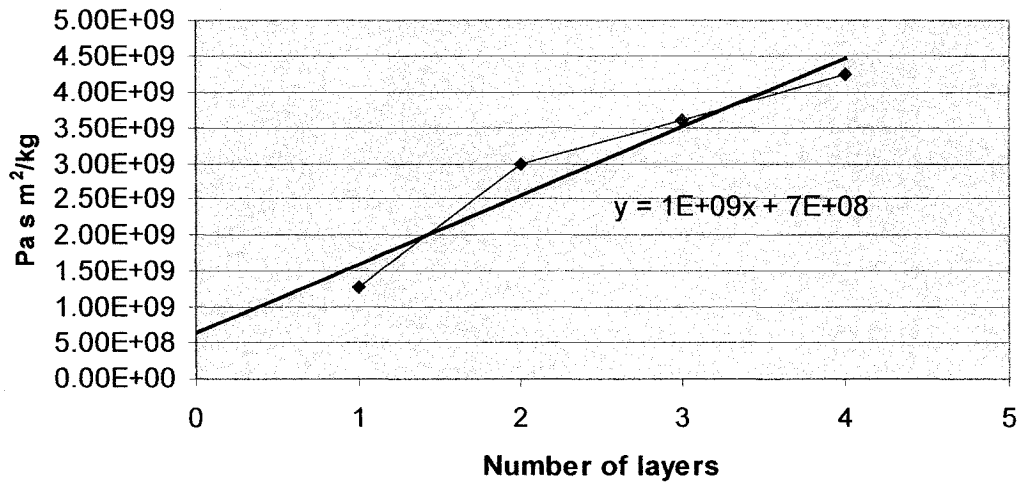

Material C5
 Modified inverted cup method (MIC)
 Liquid cup: Water 100%
 August 3rd 2002 - Beginning of test
 Temperature control: +/- 1.0 °C

Area of specimen: 0.00793 sq.m.

Thickness of material 5 in mm

Sample Layer all Point 1 0.76 Point 2 0.69 Point 3 0.68 Point 4 0.7 Average thickness 0.708

Weight of paper in grammes
 5-A 6.009

Table 1.: Recordings of weights for 5-A

Sr. No.	Time		Hours	Weights (l)		Temp. °C	Relative Humidity %	Pressure difference Δ P
	Date	Time		Wt. Of liquid Cup	New wt. Of Dry Cup			
1	18/10/2002	16:46	0.00	N/A	264.883	23.5	25.3	2880
2	20/10/2002	19:31	50.75	0	267.444	22.5	24.5	2339
3	22/10/2002	18:00	46.50	0	263.942	21.6	21.1	2632
4	24/10/2002	16:16	46.25	0	261.972	23.0	20.1	2811
5	26/10/2002	16:16	48.00	0	261.808	22.9	30.1	2396
6	28/10/2002	15:46	48.50	0	261.825	22.9	22.4	2396
7	30/10/2002	16:16	48.50	0	261.450	22.4	19.9	2325
8	01/11/2002	17:16	49.00	0	263.974	22.5	22.0	2339

Daylight savings time one hour added.

Table 2.: Water Vapour Transmission through material in 5-A

Sr. No.	Weight change in cups			Time		Weight change per unit time			q/A		Permeance		Resistance		
	Water Cup	Dry Cup	Specimen Cup	Days	Hours	Seconds	dW/dt	dDes/dt (g/s)	dSp/dt	Solution Side	Desiccant Side	Solution Side	Desiccant Side	Solution Side	Desiccant Side
1	0	0.000	0.000	0	0.00	0	0	0.0000066	0	0.0000018	0	0	0	1.32E+09	0
2	0	2.561	1.198	2	50.75	182700	0	0.0000140	0	0.0000031	0	0	0	7.557E-10	0
3	0	4.086	0.154	2	46.50	167400	0	0.0000244	0.0000009	0.0000031	0	0	0	1.17E-09	0
4	0	2.462	0.191	2	46.25	166500	0	0.0000148	0.0000011	0.0000019	0	0	0	6.635E-10	0
5	0	2.884	0.164	2	48.00	172800	0	0.0000167	0.0000009	0.0000021	0	0	0	8.783E-10	0
6	0	2.277	0.066	2	48.50	174600	0	0.0000130	0.0000004	0.0000016	0	0	0	6.863E-10	0
7	0	3.131	0.131	2	48.50	174600	0	0.0000179	0.0000008	0.0000023	0	0	0	9.727E-10	0
8	0	2.524	0.037	2	49.00	176400	0	0.0000143	0.0000002	0.0000018	0	0	0	7.714E-10	0
														Average	1.23E+09
														Steady state average	1.29E+09

Material C5
 Modified inverted cup method (MIC)
 Liquid cup: Water 100%
 August 3rd 2002 - Beginning of test
 Temperature control: $\pm 1.0^\circ\text{C}$

Area of specimen: 0.00793 sq.m.

Thickness of material 5 in mm

Sample Layer all Point 1 1.34 Point 2 1.36 Point 3 1.38 Point 4 1.39 Average thickness per layer 1.3675

Weight of paper in grammes
 5-B 11.832

Table 1: Recordings of weights for 5-B

Sr. No.	Date	Time	Hours	Weights (1)			Temp. $^\circ\text{C}$	Relative Humidity %	Pressure difference ΔP
				Wt. Of liquid Cup	New wt. Of Dry Cup	Wt. Of Ring + Specimen			
1	18/10/2002	16:50	0.00	0	N/A	413.491	23.5	2880	
2	20/10/2002	19:35	50.75	0	414.147	414.839	22.5	2339	
3	22/10/2002	18:04	46.50	0	413.235	415.351	21.6	2632	
4	24/10/2002	16:20	46.25	0	414.105	414.466	23.0	2811	
5	26/10/2002	16:20	48.00	0	413.631	415.355	22.9	2396	
6	28/10/2002	15:50	48.50	0	415.377	414.911	22.9	2396	
7	30/10/2002	16:20	48.50	0	413.231	416.873	22.4	3247	
8	01/11/2002	17:20	49.00	0	N/A	414.457	22.5	3266	

Daylight savings time one hour added

Table 2: Water Vapour Transmission through material in 5-B

Sr. No.	Weight change in cups			Time		Weight change per unit time		q/A		Permeance		Resistance	
	Water Cup	Dry Cup	Specimen Cup	Days	Hours	dW/dt	dDes/dt (g/s)	Solution Side	Desiccant Side	Solution Side	Desiccant Side	Solution Side	Desiccant Side
1	0	0.000	0.000	0	0.00	0	0.0000074	0	0.0000009	0	3.978E-10	0	2.514E+09
2	0	1.348	0.886	2	50.75	182700	0.0000008	0	0.0000009	0	3.446E-10	0	2.902E+09
3	0	1.204	0.136	2	46.50	167400	0.0000074	0	0.0000009	0	3.317E-10	0	3.014E+09
4	0	1.231	0.171	2	46.25	166500	0.0000072	0	0.0000009	0	3.807E-10	0	2.627E+09
5	0	1.250	0.117	2	48.00	172800	0.0000073	0	0.0000009	0	3.858E-10	0	2.592E+09
6	0	1.280	-0.076	2	48.50	174600	0.0000086	0	0.0000011	0	3.328E-10	0	3.005E+09
7	0	1.496	0.133	2	48.50	174600	0.0000070	0	0.0000009	0	2.683E-10	0	3.727E+09
8	0	1.226	-0.013	3	49.00	176400	0.0000001	0	0.0000009	0	2.812E+09	0	2.993E+09
Average													2.812E+09
Steady state average													2.993E+09

Material C5
 Modified inverted cup method (MIC)
 Liquid cup: Water 100%
 August 3rd 2002 - Beginning of test
 Temperature control: +/- 1.0 °C

Area of specimen: 0.00793 sq.m.

Thickness of material 5 in mm

Sample Layer all Point 1 2.1 Point 2 2.12 Point 3 2.15 Point 4 1.94 Average thickness per layer 2.0775

Weight of paper in grammes
 5-C 17.796

Table 1: Recordings of weights for 5-C

Sr. No.	Date	Time		Hours	Weights (1)		Temp. °C	Relative Humidity %	Pressure difference Δ P
		Time	Time		Wt. Of liquid Cup	New wt. Of Dry Cup			
1	18/10/2002	16:54	0:00	0.00	N/A	228.231	23.5	25.3	2880
2	20/10/2002	19:39	50:75	0	228.640	229.152	22.5	24.5	2339
3	22/10/2002	18:08	46:50	0	229.668	229.510	21.6	21.1	2632
4	24/10/2002	16:24	46:25	0	229.269	230.568	23.0	20.1	2811
5	26/10/2002	16:24	48:00	0	228.814	230.185	22.9	30.1	2396
6	28/10/2002	15:54	48:50	0	228.989	229.775	22.9	22.4	2396
7	30/10/2002	16:24	48:50	0	228.901	229.933	22.4	19.9	2325
8	01/11/2002	17:24	49:00	0	N/A	229.846	22.5	22.0	2339

Daylight savings time one hour added

Table 2: Water Vapour Transmission through material in 5-C

Sr. No.	Weight change in cups		Time		Weight change per unit time		q/A		Permeance		Resistance				
	Water Cup	Dry Cup	Specimen Cup	Days	Hours	Seconds	dW/dt	dDes/dt (g/s)	dSp/dt	Solution Side	Desiccant Side	Solution Side	Desiccant Side		
1	0	0.000	0.000	0	0.00	0	0	0.0000050	-0.0000031	0	0.0000006	0	2.718E-10	0	3.68E+09
2	0	0.821	-0.573	2	50:75	182700	0	0.0000052	0.0000004	0	0.0000007	0	2.49E-10	0	4.02E+09
3	0	0.870	0.065	2	46:50	167400	0	0.0000054	0.0000010	0	0.0000007	0	2.425E-10	0	4.12E+09
4	0	0.900	0.162	2	46:25	166500	0	0.0000053	0.0000006	0	0.0000007	0	2.79E-10	0	3.58E+09
5	0	0.916	0.109	2	48:00	172800	0	0.0000055	-0.0000008	0	0.0000007	0	2.897E-10	0	3.45E+09
6	0	0.961	-0.139	2	48:50	174600	0	0.0000054	0.0000010	0	0.0000007	0	2.933E-10	0	3.41E+09
7	0	0.944	0.177	2	48:50	174600	0	0.0000054	0.0000002	0	0.0000007	0	2.888E-10	0	3.46E+09
8	0	0.945	0.037	3	49:00	176400	0	0.0000054	0.0000002	0	0.0000007	0	2.888E-10	0	3.46E+09
Average												Steady state average		3.61E+09	

Material C5
 Modified inverted cup method (MIC)
 Liquid cup: Water 100%
 August 3rd 2002 - Beginning of test
 Temperature control: +/- 1.0 °C

Area of specimen: 0.00793 sq. m.

Thickness of material 5 in mm

Sample	Layer	Point 1	Point 2	Point 3	Point 4	Average thickness per layer
5-D	all	2.72	2.7	3.38	3.32	3.03

Weight of paper in grammes
 5-D 23.848

Table 1.: Recordings of weights for 5-D

Sr. No.	Time		Weights (1)			Temp. °C	Relative Humidity %	Pressure difference Δ P
	Date	Time	Hours	Wt. Of Liquid Cup	New wt. Of Dry Cup			
1	18/10/2002	16:58	0.00	0	N/A	23.5	25.3	2880
2	20/10/2002	19:43	50.75	0	350.465	22.5	24.5	2339
3	22/10/2002	18:12	46.50	0	350.493	21.6	21.1	2632
4	24/10/2002	16:30	46.25	0	411.297	23.0	20.1	2811
5	26/10/2002	16:30	48.00	0	411.550	22.9	30.1	2396
6	28/10/2002	16:00	48.50	0	411.024	22.9	22.4	2396
7	30/10/2002	16:30	48.50	0	411.906	22.4	19.9	2325
8	01/11/2002	17:30	49.00	0	N/A	22.5	22.0	2339

Daylight savings time, one hour added.

Table 2.: Water Vapour Transmission through material in 5-D

Sr. No.	Weight change in cups			Time			Weight change per unit time			q/A		Permeance		Resistance	
	Water Cup	Dry Cup	Specimen Cup	Days	Hours	Seconds	dW/dt	dDes/dt	dSp/dt	Solution Side	Desiccant Side	Solution Side	Desiccant Side	Solution Side	Desiccant Side
1	0	0.000	0.000	0	0.00	0									
2	0	0.737	1.174	2	50.75	182700	0.0000040	0.0000064	0.0000064	0	0.0000005	0	2.17469E-10	0	4.598E+09
3	0	0.727	0.081	2	46.50	167400	0.0000043	0.0000005	0.0000005	0	0.0000005	0	2.08091E-10	0	4.806E+09
4	0	0.832	0.224	2	46.25	166500	0.0000050	0.0000013	0.0000013	0	0.0000006	0	2.24209E-10	0	4.46E+09
5	0	0.778	0.125	2	48.00	172800	0.0000045	0.0000007	0.0000007	0	0.0000006	0	2.36938E-10	0	4.221E+09
6	0	0.811	-0.108	2	48.50	174600	0.0000046	-0.0000006	0.0000006	0	0.0000006	0	2.44441E-10	0	4.091E+09
7	0	0.797	0.153	2	48.50	174600	0.0000046	0.0000009	0.0000009	0	0.0000006	0	2.47594E-10	0	4.039E+09
8	0	0.731	0.106	3	49.00	176400	0.0000041	0.0000006	0.0000006	0	0.0000005	0	2.23402E-10	0	4.478E+09
Average															4.354E+09
Steady state average															4.267E+09

Material C5
Modified inverted cup (MIC)
Temperature control: $\pm 1.5^\circ\text{C}$

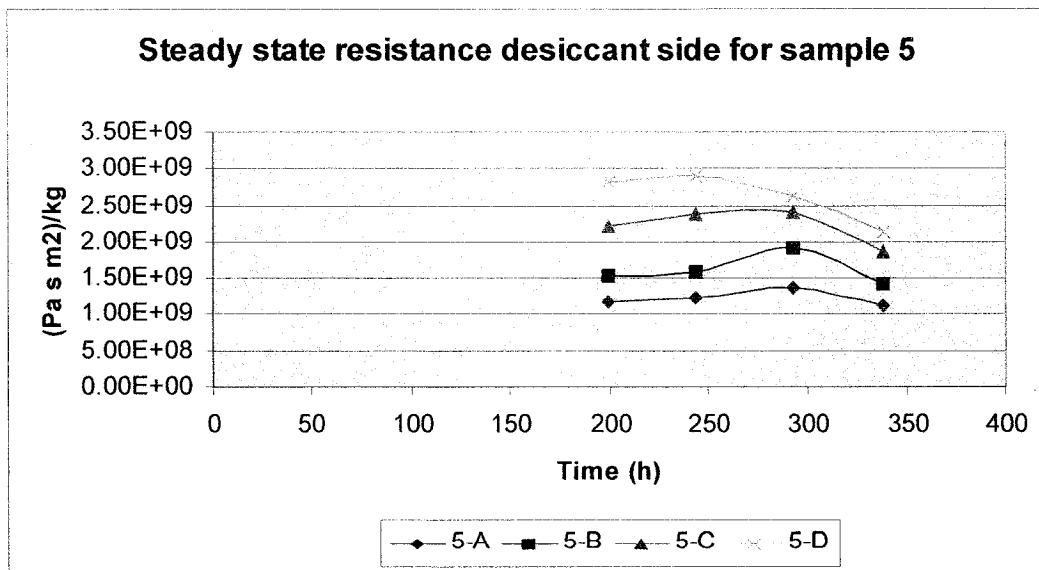
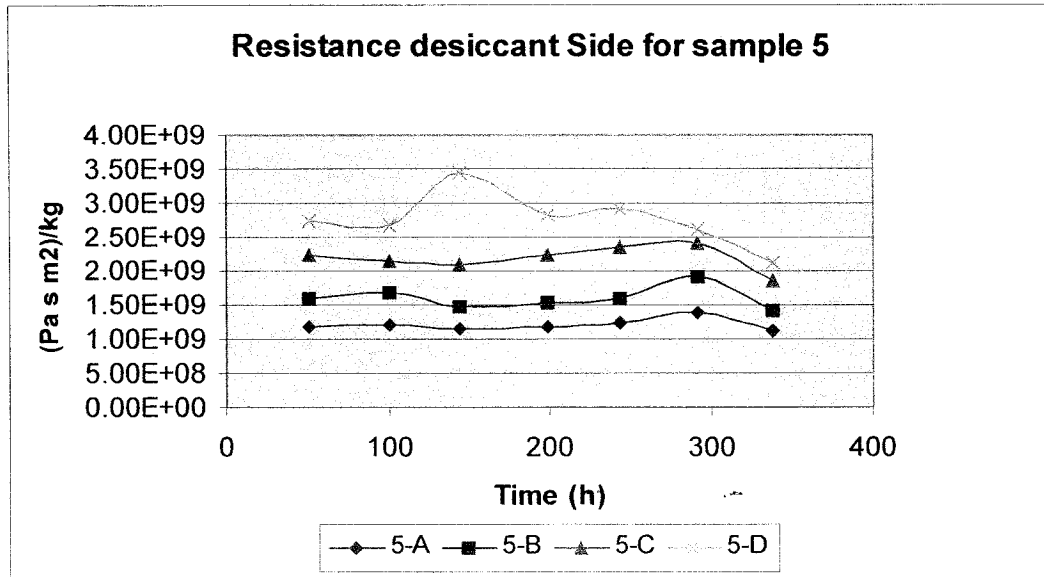

Steady state rsistance intercept values for sample 5

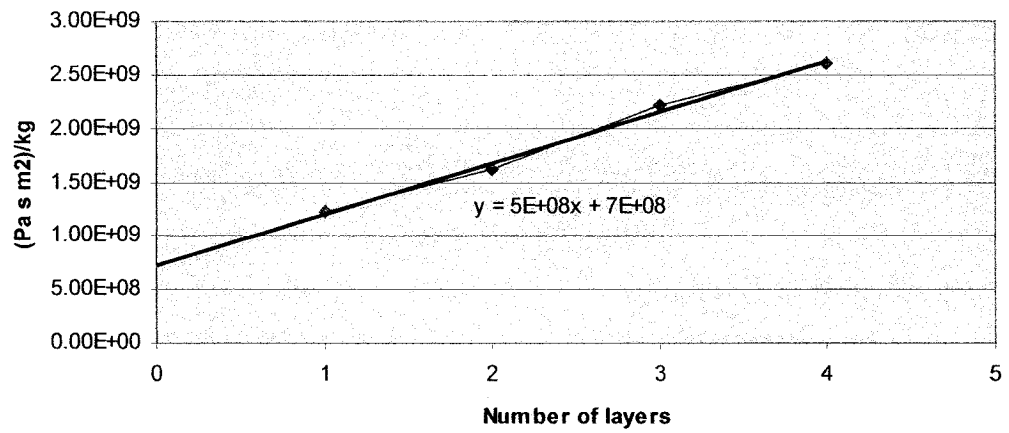

Material C5
 Modified inverted cup method (MIC)
 August 3rd 2002 - Beginning of test
 Temperature control: +/- 1.5 °C

Area of specimen: 0.00793 sq.m.

Thickness of material C5 in mm
 Sample Layer Point 1 Point 2 Point 3 Point 4
 5-A 1 0.68 0.65 0.67 0.69

Average thickness
 0.673

Weight of paper in grammes
 5-A 5.93

Table 1.: Recordings of weights for 5-A

Sr. No.	Time		Hours	Weights (1)		Temp. °C	Relative Humidity %	Pressure difference Δ P
	Date	Time		Wt. Of liquid Cup	New wt. Of Dry Cup			
1	03/08/2002	12:15	0.00	0.000	N/A	430.200	51.0	2868
2	05/08/2002	15:45	51.50	0.000	429.872	433.796	53.0	2863
3	07/08/2002	16:15	48.50	0.000	428.580	433.240	44.0	2898
4	09/08/2002	12:15	44.00	0.000	428.810	429.760	47.0	2880
5	11/08/2002	19:15	55.00	0.000	429.570	432.740	49.0	2950
6	13/08/2002	16:15	45.00	0.000	430.770	432.800	55.6	3114
7	15/08/2002	15:45	48.50	0.000	426.145	434.010	55.4	3208
8	17/08/2002	14:45	46.00	0.000	N/A	429.825	49.0	3132

Table 2.: Water Vapour Transmission through material in 5-A

Sr. No.	Weight change in cups		Specimen	Days		Time		Weight change per unit time		q/A		Permeance		Resistance	
	Water Cup	Dry Cup		Days	Hours	Seconds	dW/dt	dDes/dt	dSp/dt	Solution Side	Desiccant Side	Solution Side	Desiccant Side	Solution Side	Desiccant Side
1	0.000	0.000	0.000	0.00	0	0.0000000	0.0000194	0.0000084	0.0000024	0.0000024	8.5434E-10	8.5434E-10	1.17E+09	1.17E+09	
2	0.000	3.596	1.557	51.50	185400	0.0000000	0.0000193	0.0000009	0.0000024	0.0000024	8.3942E-10	8.3942E-10	1.19E+09	1.19E+09	
3	0.000	3.368	0.163	48.50	174600	0.0000000	0.0000201	0.0000022	0.0000025	0.0000025	8.7892E-10	8.7892E-10	1.14E+09	1.14E+09	
4	0.000	3.180	0.350	44.00	158400	0.0000000	0.0000198	-0.0000007	0.0000025	0.0000025	8.4639E-10	8.4639E-10	1.18E+09	1.18E+09	
5	0.000	3.930	-0.130	55.00	198000	0.0000000	0.0000199	0.0000006	0.0000025	0.0000025	8.0739E-10	8.0739E-10	1.24E+09	1.24E+09	
6	0.000	3.230	0.100	45.00	162000	0.0000000	0.0000186	0.0000002	0.0000023	0.0000023	7.2942E-10	7.2942E-10	1.37E+09	1.37E+09	
7	0.000	3.240	0.030	48.50	174600	0.0000000	0.0000222	0.0000005	0.0000028	0.0000028	8.9459E-10	8.9459E-10	1.25E+09	1.25E+09	
8	0.000	3.680	0.080	46.00	165600	0.0000000	0.0000222	0.0000005	0.0000028	0.0000028	8.9459E-10	8.9459E-10	1.20E+09	1.20E+09	
Average														1.20E+09	
Steady state average														1.23E+09	

Material C5
 Modified inverted cup method (MIC)
 August 3rd 2002 - Beginning of test
 Temperature control: +/- 1.5 °C

Area of specimen: 0.00793 sq.m.

Thickness of material C5 in mm

Sample Layer	Point 1	Point 2	Point 3	Point 4	Average thickness per layer
1	0.68	0.7	0.69	0.67	0.685
2	0.69	0.67	0.69	0.69	0.685
Average thickness					1.370

Weight of paper in grammes
 5-B 11.8

Table 1: Recordings of weights for 5-B

Sr. No.	Date	Time	Weights (1)			Temp. °C	Relative Humidity %	Δ P
			Wt. Of liquid Cup	New wt. Of Dry Cup	Wt. Of Ring + Specimen			
1	03/08/2002	12:20	0.000	N/A	352.520	23.9	51.0	2968
2	05/08/2002	15:50	0.000	350.226	355.189	23.3	53.0	2863
3	07/08/2002	16:20	0.000	349.045	352.615	23.5	44.0	2898
4	09/08/2002	12:20	0.000	350.140	351.530	23.1	47.0	2880
5	11/08/2002	19:20	0.000	351.540	353.170	23.8	49.0	2950
6	13/08/2002	14:20	0.000	343.950	354.050	24.7	55.6	3114
7	15/08/2002	15:45	0.000	349.290	346.320	25.8	55.4	3208
8	17/08/2002	14:45	0.000	N/A	352.185	24.8	49.0	3132

Table 2: Water Vapour Transmission through material in 5-B

Sr. No.	Weight change in cups			Time			Weight change per unit time			q/A		Permeance		Resistance		
	Water Cup	Dry Cup	Specimen	Days	Hours	Seconds	dW/dt	dDes/dt	dSp/dt	Solution Side	Desiccant Side	Solution Side	Desiccant Side	Solution Side	Desiccant Side	
1	0.000	0.000	0.000	0	0.00	0	0.0000000	0.0000144	0.0000080							
2	0.000	2.669	1.477	2	51.50	185400	0.0000000	0.0000137	0.0000016							
3	0.000	2.389	0.273	2	48.50	174600	0.0000000	0.0000157	0.0000154							
4	0.000	2.485	2.440	2	44.00	158400	0.0000000	0.0000153	-0.0000052							
5	0.000	3.030	-1.020	2	55.00	198000	0.0000000	0.0000155	-0.0000036							
6	0.000	2.510	-0.590	2	45.00	162000	0.0000000	0.0000133	-0.0000003							
7	0.000	2.370	-0.050	2	49.42	177900	0.0000000	0.0000175	0.0000003							
8	0.000	2.895	0.050	3	46.00	165600	0.0000000	0.0000175	0.0000003							
Average										1.577E+09	1.679E+09	6.341E-10	5.95419E-10	6.86828E-10	6.541E-10	1.577E+09
Steady state average										1.613E+09	7.03764E-10	0.0000022	0.0000022	0.0000022	0.0000022	0.0000022

Material C5
 Modified inverted cup method (MIC)
 August 3rd 2002 - Beginning of test
 Temperature control: +. 1.5 °C

Area of specimen: 0.00793 sq.m.

Thickness of material C5 in mm

Sample Layer	Point 1	Point 2	Point 3	Point 4	Average thickness per layer
5-C	1	0.68	0.69	0.68	0.6825
	2	0.69	0.69	0.67	0.68
	3	0.69	0.69	0.67	0.685
					Thickness 2.048

Weight of paper in grammes
 5-C
 17.78

Table 1.: Recordings of weights for 5-C

Sr. No.	Date	Time		Weights (1)			Temp. °C	Relative Humidity %	Pressure difference Δ P	
		Hours	Specimen	Wt. Of liquid Cup	Dry Cup	Wt. Of Ring + Specimen				
										Wt. Of Dry Cup
1	03/08/2002	12:25	0.00	0.000	N/A	231.960	152.420	23.9	51.0	2868
2	05/08/2002	15:55	51.50	0.000	228.430	233.840	153.968	23.3	53.0	2863
3	07/08/2002	16:25	48.50	0.000	226.520	230.305	154.090	23.5	44.0	2898
4	09/08/2002	12:25	44.00	0.000	225.620	228.260	154.250	23.1	47.0	2880
5	11/08/2002	19:25	55.00	0.000	227.150	227.700	154.360	23.8	49.0	2950
6	13/08/2002	16:25	45.00	0.000	226.200	228.840	154.350	24.7	55.6	3114
7	15/08/2002	15:50	47.42	0.000	226.155	228.000	154.620	25.8	55.4	3208
8	17/08/2002	14:50	46.00	0.000	N/A	228.360	154.615	24.8	49.0	3132

Table 2.: Water Vapour Transmission through material in 5-C

Sr. No.	Weight change in cups			Time			Weight change per unit time			g/A		Permeance		Resistance			
	Water Cup	Dry Cup	Specimen	Days	Hours	Seconds	dW/dt	dDes/dt (g/s)	dSp/dt	Solution Side	Desiccant Side	Solution Side	Desiccant side	Solution Side	Desiccant side		
																(Pa s m ³)/kg	(Pa s m ³)/kg
1	0.000	0.000	0.000	0	0.00	0	0.0000000	0.0000101	0.0000083	0.0000013	0.0000014	4.4665E-10	2.24E+09	2.14E+09	2.08E+09		
2	0.000	1.890	1.548	2	51.50	185400	0.0000000	0.0000107	0.0000007	0.0000014	0.0000014	4.67313E-10	4.80918E-10	4.49019E-10	2.23E+09		
3	0.000	1.875	0.122	2	48.50	174600	0.0000000	0.0000110	0.0000010	0.0000014	0.0000014	4.22445E-10	4.22445E-10	4.14494E-10	1.87E+09		
4	0.000	1.740	0.160	2	44.00	158400	0.0000000	0.0000105	0.0000006	0.0000013	0.0000013	4.14494E-10	4.14494E-10	4.14494E-10	1.87E+09		
5	0.000	2.080	0.110	2	55.00	198000	0.0000000	0.0000104	-0.0000001	0.0000013	0.0000013	5.36027E-10	5.36027E-10	5.36027E-10	1.87E+09		
6	0.000	1.890	-0.010	2	45.00	162000	0.0000000	0.0000105	0.0000016	0.0000016	0.0000016	5.36027E-10	5.36027E-10	5.36027E-10	1.87E+09		
7	0.000	1.800	0.270	2	47.42	170700	0.0000000	0.0000133	0.0000000	0.0000017	0.0000017	5.36027E-10	5.36027E-10	5.36027E-10	1.87E+09		
8	0.000	2.205	-0.005	3	46.00	165600	0.0000000	0.0000133	0.0000000	0.0000017	0.0000017	5.36027E-10	5.36027E-10	5.36027E-10	1.87E+09		
																Average	
																	Steady state average

Material C6
 Modified inverted cup method (MIC)
 August 3rd 2002 - Beginning of test
 Temperature control: +/- 1.5 °C

Area of specimen: 0.00793 sq.m.

Sample 5-D	Layer	Point 1	Point 2	Point 3	Point 4	Average thickness per layer
1	1	0.67	0.71	0.7	0.69	0.6925
2	2	0.69	0.68	0.68	0.69	0.685
3	3	0.7	0.67	0.66	0.68	0.6775
4	4	0.68	0.67	0.67	0.67	0.6725
						Average thickness 0.682

Weight of paper in grammes

5-D 23.71

Table 1.: Recordings of weights for 5-D

Sr. No.	Time		Weights (1)				Temp. °C	Relative Humidity %	Pressure difference Δ P
	Date	Time	Hours	Wt. Of liquid Cup	New wt. Of Dry Cup	Wt. Of Ring + Specimen			
1	03/08/2002	12:30	0.00	0.000	N/A	418.060	23.9	51.0	2968
2	05/08/2002	16:00	51.50	0.000	414.823	419.589	23.3	53.0	2863
3	07/08/2002	16:30	48.50	0.000	414.405	416.330	23.5	44.0	2898
4	09/08/2002	12:30	44.00	0.000	413.060	415.460	23.1	47.0	2880
5	11/08/2002	19:30	55.00	0.000	414.770	414.700	23.8	49.0	2950
6	13/08/2002	16:30	45.00	0.000	414.900	416.150	24.7	55.6	3114
7	15/08/2002	15:30	47.00	0.000	414.240	416.540	25.8	55.4	3208
8	17/08/2002	14:30	46.00	0.000	N/A	416.180	24.8	49.0	3132

Table 2.: Water Vapour Transmission through material in 5-D

Sr. No.	Weight change in cups			Time			Weight change per unit time			q/A		Permeance		Resistance		
	Water Cup	Dry Cup	Specimen	Days	Hours	Seconds	dW/dt	dDes/dt (g/s)	dSpr/dt	Solution Side	Desiccant Side	Solution Side	Desiccant Side	Solution Side	Desiccant Side	
1	0.000	0.000	0.000	0	0.00	0	0.0000000	0.0000083	0.0000069	0.0000010	0.0000010	3.656E-10	3.756E-10	2.735E+09	2.662E+09	
2	0.000	1.539	1.093	2	51.50	185400	0.0000000	0.0000086	-0.0000007	0.0000011	0.0000011	3.756E-10	3.756E-10	3.429E+09	3.429E+09	
3	0.000	1.507	-0.118	2	48.50	174600	0.0000000	0.0000067	0.0000028	0.0000008	0.0000008	2.916E-10	2.916E-10	2.925E+09	2.925E+09	
4	0.000	1.055	0.445	2	44.00	158400	0.0000000	0.0000083	0.0000006	0.0000010	0.0000010	3.54E-10	3.54E-10	2.899E+09	2.899E+09	
5	0.000	1.640	0.110	2	55.00	198000	0.0000000	0.0000085	-0.0000023	0.0000011	0.0000011	3.45E-10	3.45E-10	2.825E+09	2.825E+09	
6	0.000	1.380	-0.380	2	45.00	162000	0.0000000	0.0000097	0.0000009	0.0000012	0.0000012	3.81E-10	3.81E-10	2.725E+09	2.725E+09	
7	0.000	1.640	0.155	2	47.00	169200	0.0000000	0.0000117	0.0000003	0.0000015	0.0000015	4.716E-10	4.716E-10	2.617E+09	2.617E+09	
8	0.000	1.940	0.045	3	46.00	165600	0.0000000	0.0000117	0.0000003	0.0000015	0.0000015	4.716E-10	4.716E-10	2.617E+09	2.617E+09	
															Average	2.756E+09
															Steady state average	2.617E+09

A2. Photographs

Double cup test method

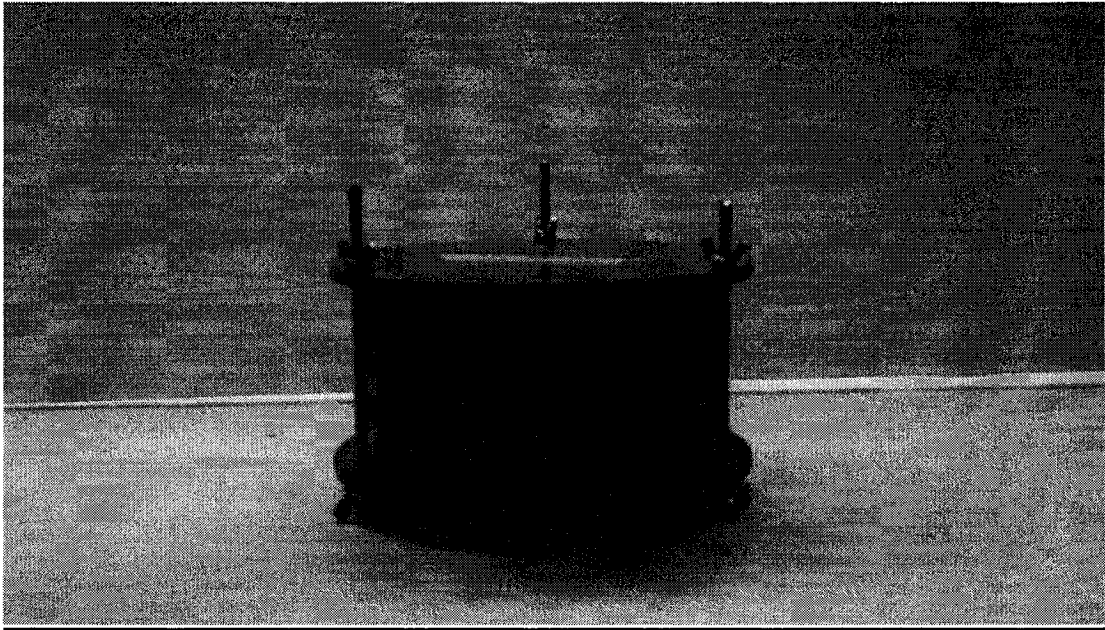

Figure A2.1. DC Test set-up.

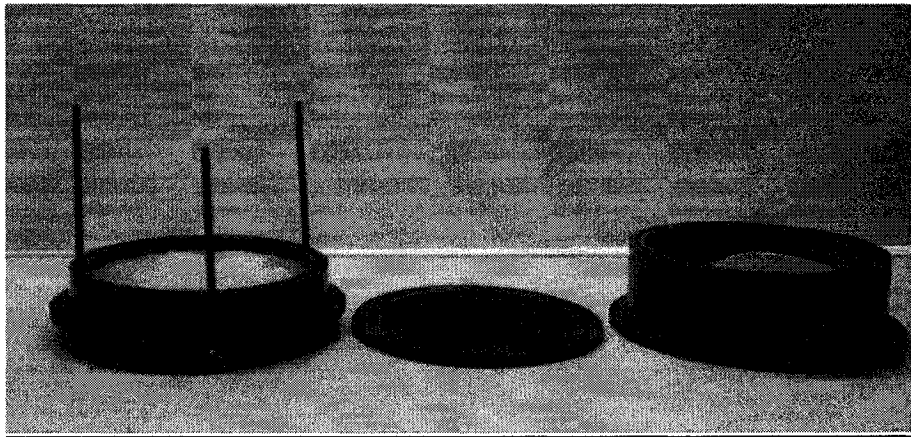

Figure A2.2. Test apparatus disassembled.

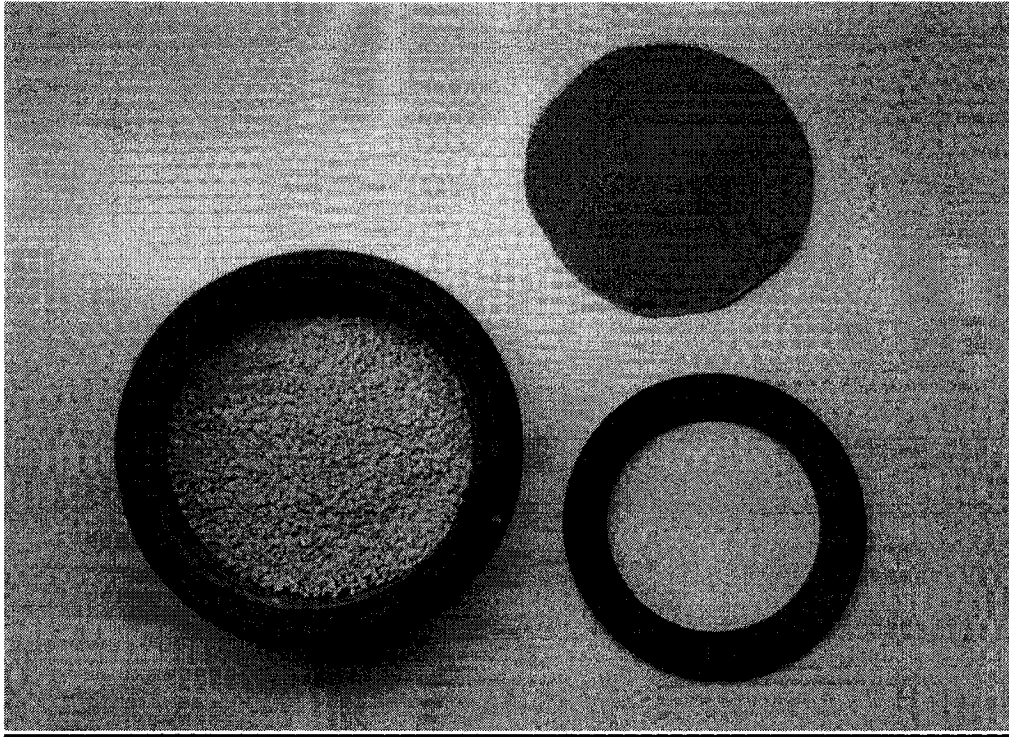

Figure A2.3. Dry cup assembly.

Modified inverted cup

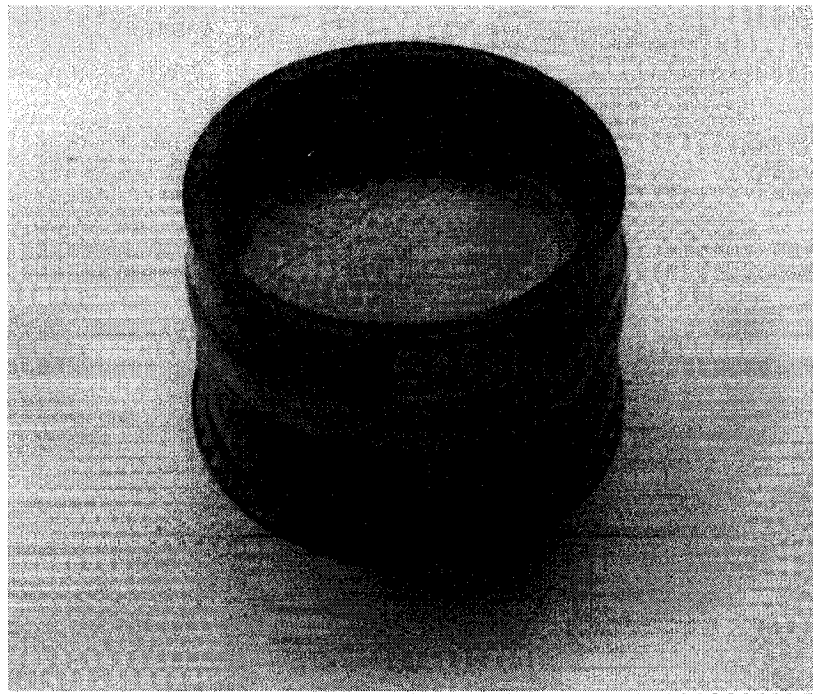

Figure A2.4. MIC Test set-up, without water on surface.

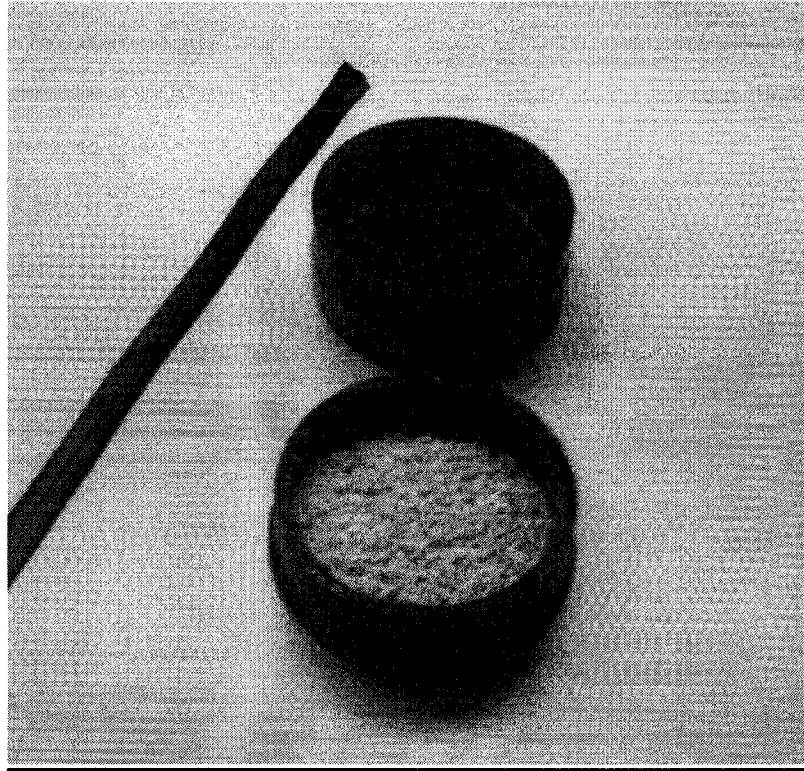

Figure A2.5. MIC test set-up disassembled without water on surface.