

NOTE TO USERS

This reproduction is the best copy available.

UMI[®]

A multi-criteria performance study of lean engineering

Yvan Beauregard

A Thesis

in

The Department

of

Mechanical and Industrial Engineering

Presented in Partial Fulfillment of the Requirements

for the Degree of Doctor of Philosophy (Mechanical Engineering)

Concordia University

Montreal, Quebec, Canada

April, 2010

© Yvan Beauregard, 2010



Library and Archives
Canada

Published Heritage
Branch

395 Wellington Street
Ottawa ON K1A 0N4
Canada

Bibliothèque et
Archives Canada

Direction du
Patrimoine de l'édition

395, rue Wellington
Ottawa ON K1A 0N4
Canada

Your file *Votre référence*
ISBN: 978-0-494-67353-9
Our file *Notre référence*
ISBN: 978-0-494-67353-9

NOTICE:

The author has granted a non-exclusive license allowing Library and Archives Canada to reproduce, publish, archive, preserve, conserve, communicate to the public by telecommunication or on the Internet, loan, distribute and sell theses worldwide, for commercial or non-commercial purposes, in microform, paper, electronic and/or any other formats.

The author retains copyright ownership and moral rights in this thesis. Neither the thesis nor substantial extracts from it may be printed or otherwise reproduced without the author's permission.

AVIS:

L'auteur a accordé une licence non exclusive permettant à la Bibliothèque et Archives Canada de reproduire, publier, archiver, sauvegarder, conserver, transmettre au public par télécommunication ou par l'Internet, prêter, distribuer et vendre des thèses partout dans le monde, à des fins commerciales ou autres, sur support microforme, papier, électronique et/ou autres formats.

L'auteur conserve la propriété du droit d'auteur et des droits moraux qui protègent cette thèse. Ni la thèse ni des extraits substantiels de celle-ci ne doivent être imprimés ou autrement reproduits sans son autorisation.

In compliance with the Canadian Privacy Act some supporting forms may have been removed from this thesis.

While these forms may be included in the document page count, their removal does not represent any loss of content from the thesis.

Conformément à la loi canadienne sur la protection de la vie privée, quelques formulaires secondaires ont été enlevés de cette thèse.

Bien que ces formulaires aient inclus dans la pagination, il n'y aura aucun contenu manquant.

■◆■
Canada

Abstract

A multi-criteria performance study of lean engineering

Yvan Beauregard, Ph.D.

Concordia University, 2010

The context of product development (PD) in the aerospace sector is one of intense competitive pressure. To ensure the continued competitiveness of this industrial sector in Canada, enhancing the productivity of PD is an urgent necessity. Key tenets of lean include value, flow and continuous improvement. In the PD context, arguments have been made that lean is not minimizing cost, cycle time or waste, but maximizing value. The research reported in this thesis supports the overarching lean goal of continuously improving the value of information flow in PD by reducing span time. While lean has been used with much success in the manufacturing world, there is an absence of comprehensive models measuring the benefits of lean improvements in PD. The first major contribution to address is the development of a lean engineering multi-criteria performance model. In addition to the lean concept of ‘one piece flow’, notions of economic order and production quantity are used in manufacturing to address the objective of flow improvement, and the related objective of inventory management. Equivalent economic design quantity concepts to address inventory of intellectual work in progress are lacking in PD. Thus, the second contribution of this work is the development of both analytical and experimental models to help ascertain the existence of optimal PD job size. The final contribution of this thesis is the development of lean

decision-making models to enable optimal allocation of PD resources, supporting the lean objective of improving the value of information flow.

Acknowledgements

Gratitude must be expressed to a number of people for their support during these years of research, first and foremost to my supervisors, Dr. Nadia Bhuiyan and Dr. Vincent Thomson, for their unwavering support, encouragement, and patience reviewing the conference and journal papers that have been either submitted, presented or published.

In the particularly difficult economic context, a note of appreciation to my current employer, for taking interest in this industrial research project, in particular the VP engineering Mr. Walter Di Bartolomeo. While coding, modeling, analysis and writing were conducted at night, over the week ends and during vacations, much sharing of ideas and discussions occurred in day time, with P&WC people. This helped contribute many concrete ideas to the management and conduct of product development activities at P&WC, and also to this thesis. I am particularly indebted to Dr. Hany Moustapha, for providing a number of opportunities to present my research in international events, and allowing research collaboration with outside research facilities, and to Mr. Christian Faucher, for insisting on practical models and solutions to the PD engineering logistics and productivity challenges I had the opportunity to work on.

As a project manager for P&WC, I had the immense opportunity over the years to work with a number of talented students, young and experienced engineers, and employees interested in taking the business of product development a stage further, to exchange ideas with them, and have applications developed to test some of the ideas

percolating from this research. I would like to thank them all for their support and patience with me.

Finally much of this work would not have been possible without the support from family, and inspiration from my parents. I would to thank my wife Rozanne for making all this possible, and my children Jonathan, Caroline and Guillaume for their understanding. I had a dream to realize, and wanted to provide a model to the young ones, that everything is possible, as long as you believe in it, have fun, and work hard. This is a very small step for humanity, but a big accomplishment for me. The coming months will provide a welcomed opportunity to rebalance the work, play and family time.

Dedication

This work is dedicated to the loving memory of my mother, Odette Soucy, a lifelong example of courage, tenacity and strength for all of her family.

Table of Contents

1. Prologue	1
1.1 Introduction.....	2
1.2 Objectives and Scope of the Dissertation	6
1.3 Thesis Outline	11
2. Background and Literature Review	13
2.1 Importance of a Multi-Criteria Lean Engineering Performance Study	13
2.2 Literature Review.....	14
2.2.1 Lean Manufacturing.....	14
2.2.2 Lean Engineering.....	17
2.2.3 Lean engineering performance measurement.....	25
2.2.4 Lean engineering job sizing.....	34
2.3 Summary.....	39
3. Multi-Criteria Lean Engineering Performance Model.....	41
3.1 Motivation.....	41
3.2 Background.....	42
3.3 Lean Engineering Performance Measurement Model	46
3.4 Post-Certification Lean Engineering Taxonomy	53
3.5 Benchmarking Results	58
3.6 Discussion.....	62
3.7 Conclusion	71

4. Optimal Engineering Job Size	72
4.1 Motivation.....	72
4.2 Background.....	73
4.2.1 Optimally Sized Jobs for Engineering	74
4.2.2 Discrete Event Simulation	77
4.3 Engineering Job Sizing approach.....	79
4.3.1 Economic Design Quantity (EDQ) Analytical Model	79
4.3.2 Simulation model	88
4.4 Results.....	90
4.4.1 EDQ Analytical Results.....	90
4.4.2 DES Experimental Results.....	92
4.5 Discussion.....	97
4.5.1 EDQ	97
4.5.2 DES	100
4.6 Conclusions.....	101
5. Engineering PD Value Optimization	102
5.1 Motivation.....	102
5.2 Background.....	104
5.3 Engineering task value and resource allocation optimization models.....	108
5.3.1 Multi-Attribute Value (MAVT) Model	108
5.3.2 Medium Term Resource Allocation Models.....	109
5.3.3 Short Term Resource Allocation Model	115
5.4 Results.....	118

5.4.1 MAVT	118
5.4.2 Medium-Term Resource Allocation	120
5.4.3 Short-Term Resource Allocation Results	125
5.5 Discussion	129
5.5.1 MAVT	129
5.5.2 Medium-Term	130
5.5.3 Short-term	131
5.6 Conclusions	134
6. Conclusions and Future Directions	136
6.1 Summary	137
6.1.1 Multi-Criteria Lean Engineering Performance Model	138
6.1.2 Optimal Engineering Job Size	139
6.1.3 Engineering PD Value Optimization	140
6.2 Future Directions	142
6.2.1 Multi-criteria lean engineering performance model	142
6.2.2 Optimal engineering job size	142
6.2.3 Engineering PD value optimization	143
Bibliography	144
Appendix 1 – Selected Value Stream PD Jobs	151
Appendix 2 - Data Acquisition, Descriptive Statistics and Code	158
Appendix 3 – Economic Design Quantity (EDQ) model code	198
Appendix 4 – Discrete Event Simulation Code and Results	204
.....	

List of Figures

Figure 1. PD system elements.....	7
Figure 2. Research scope	11
Figure 3. Key lean historical milestones (Murman et al., 2002).....	15
Figure 4. Aerospace PD stages – Chase (2000).....	18
Figure 5. The factors related to value for a customer – Browning (2000).....	19
Figure 6. Stage Gate Process	56
Figure 7. Post-Certification Taxonomy and Decision Tree	58
Figure 8. Key Metrics Benchmarking.....	61
Figure 9. PD Task Concurrency.....	82
Figure 10. Concurrency Factor	83
Figure 11. Focus Factor	84
Figure 12. Rework Waste Factor	85
Figure 13. IWIP Profile.....	86
Figure 14. Simulation Model	88
Figure 15. Charge Distribution	90
Figure 16. Q^* for c and f.....	91
Figure 17. Optimal Regions.....	92
Figure 18. Task size to LT and Setup Waste	97
Figure 19. Current to Optimal TRC.....	99
Figure 20. Lean decision making tradeoff scorecard.....	120
Figure 21. Estimated effort	123
Figure 22. Comparison of estimated to allocated resources	123

Figure 23. Positive earned effort.....	124
Figure 24. Earned effort penalty	124
Figure 25. Earned Effort Value versus Budget.....	125
Figure 26. OBS demand.....	126
Figure 27. Reasonable Schedule.....	129
Figure 28. Additional characterization of Product charged hours distribution.....	182
Figure 29. All jobs charged hours distribution - plot.....	194
Figure 30. All jobs charged hours distribution - with predicted exponential cdf.....	195
Figure 31. Job charge size distribution by employee.....	196
Figure 32. Charge hours distribution by employee.....	197
Figure 33. DES simple three jobs and five employees model	205
Figure 34. Capture of job statistics	208
Figure 35. Concurrency control logic	209
Figure 36. Simulation start conditions	209
Figure 37. Simulation stop conditions	210
Figure 38. High level product simulation model	211

List of Tables

Table 1: PD performance metrics benchmarking	60
Table 2. DES results for $f=.15$, $c=.26$	93
Table 3. Factorial fit for LT vs c and f.....	94
Table 4. Engineering tasks value dimensions and criteria	119
Table 5. Realized value and implicit value increase results	121
Table 6. Lean engineering logistics game dataset	127
Table 7. Optimal lean engineering logistics model results	128
Table 8. System job type classification.....	153
Table 9. Statistics for charge Product controls employees over 09-2006 to 09-2008 period) in arrae.....	192
Table 10. Employee charge distribution to Product control jobs, and 'others' [0906-0908] in nt	193

1. Prologue

Product development (PD) is defined as “the set of activities beginning with the perception of a market opportunity and ending in the production, sale and delivery of a product” (Ulrich, Eppinger, 2004). Complex PD systems, such as those found in aerospace endeavors, are often plagued by a lack of information flow, (Oppenheim, 2004). Information, in the form of requirements, performance models, drawings, understanding of the risk related to a particular design, etc., constitutes in essence what engineers work with and produce, hopefully leading to a successful product or service for the businesses that employ them. Inadequate information flow leads to much waste, rework, waiting time, and cost overruns in projects.

To tackle the information flow problem, proponents of the lean approach in manufacturing have instituted the ‘one piece flow’ philosophy, a state of mind as well as a reality, where the size of the lot of goods moving from one operation to the next is as close as possible to unity (Liker, 2004). By investing much effort and thought in perfecting setups, such that the influence of changeovers on production unit capacity becomes negligible, the low quantity of parts moving from one operation to the next ensures minimal delays in preventing quality issues, understanding customer demand, and generally lowering the waste associated with rework and inventory.

The research presented in this thesis is motivated by the fact that the equivalent ‘one piece flow’ concept in PD systems is still elusive at this point in time. This research examines the question of information value flow from the viewpoint of a novel lean PD performance model. A novel analytical model and a PD discrete event simulation model is developed to further examine the influence of job size on PD lean performance, and

ascertain the presence of an optimal job size, where job size is defined as the quantity of effort hours required to complete a given deliverable in a PD endeavor. Taking note that managerial decision-making about resource allocation to engineering jobs influences the flow of information, the influence of resource allocation on PD earned value is examined through novel multi-attribute value and linear optimization models. Earned value is “a method for measuring project performance, comparing the amount of work that was planned with what was actually accomplished” (PMI, 1996).

1.1 Introduction

The aerospace sector is important to Canada with sales of 21.8B\$, exports of 18.5B\$, and 75,000 jobs in 2005 (Office des Technologies Industrielles, 2007). Canadian manufacturers are facing many challenges in their quest to remain competitive. Factors such as the rise of the Canadian dollar relative to US currency, and its impact on the relative productivity of Canadian industry, the sharp increase in energy prices, and the availability of low cost manpower in developing countries impact the competitiveness of Canadian companies (Réseau des ingénieurs du Québec, 2007). Achieving engineering productivity improvement in the context of global competition, limited availability of local resources, corporate demands for positive short term cash flow, and shareholder expectations for increasing return on investment involve considerations for subcontracting engineering work to low cost sources. Nowadays, many advanced engineering organizations participating in the design and development of complex aerospace products also consider transforming themselves into ‘leaner machines’. A necessary shift of culture is of paramount importance in helping to ensure that businesses respond to customer expectations for affordability, remain viable over the longer term,

and provide a reasonable answer to employee aspirations for their efforts to add value. Among the many approaches to engineering PD improvement, 'lean in engineering' is of particular interest to this research. Lean is the term originally used to describe a manufacturing philosophy. Lean manufacturing consists of a set of principles that are customer focused and knowledge driven, and strives to eliminate waste and create value, dynamically and continuously (Browning, 2000). It is a system made of a set of tools and processes with the most commonly understood objective of reducing waste. Lean applications to engineering activities are a relatively more recent phenomenon. One of the main objectives of lean in engineering is improving the flow of information; this is at the origin of this research proposal.

The emergence of lean in engineering is quite recent. The nature of PD activities in engineering is very different than the more repetitive manufacturing activities. 'Achieving flow' in engineering is of considerable importance: better flow leads to shorter lead time and provides earlier feedback on design suitability to meet requirements (Morgan, Liker, 2006). Key lean manufacturing principles, such as achieving flow, have been translated into the 'one piece flow' concept with much success in the manufacturing world, while equivalent notions in the engineering environment are still elusive at this point. Proper engineering systems are required to deliver improved flow, reduce work in progress, and enable customer pull.

The following quotation from Taiichi Ohno, Toyota, reflects a central meaning of lean "The only thing we do, is to look at the time which passes from the moment we receive the customer's order until its payment. We constantly seek to reduce this time by eliminating all the non-valued activities." (Ohno, 1988) Thus, lean is depicted as

improving flow by reducing the time from customer order to cash. The overall goal of this thesis is to examine the information value flow in PD to minimize span time.

The engineering value stream focuses on the upfront processes from the capture of needs up to their transformation into a coherent set of ideas, designs and plans, and is thus supporting subsequent value added activities. The upfront PD carried out in the engineering value stream influences the competitiveness of the downstream manufacturing value stream. Value Stream Mapping (VSM) is used to achieve this objective, where a value stream is defined as being all the actions (both value added and non-value added) currently required to bring a product through the main flows essential to every product (Rother and Shook, 2003). There is the production flow, starting from raw material and ending with the end product in the hands of the customer, and there is the design flow, starting from concept or need to launch of product. A value stream viewpoint, as opposed to a silo based one, is essential for achieving improvement. Waste unfortunately constitutes approximately 60% of the work performed in engineering (Womack and Jones, 2003).

Models measuring PD productivity, efficiency, and effectiveness are thus required to direct efforts and resources, and to assess whether the anticipated improvements have materialized. However, comprehensive models of this nature are almost nonexistent in a lean environment. Browning (2000) defines PD effort as the engineering development of knowledge about the product, or as a process of eliminating the uncertainty of the product. He has proposed a conceptual model for defining value to the customer in PD as characterized by multiple criteria of process, product, quality and performance, affordability, and finally availability. The performance of the PD process is dependent

on multiple criteria, where the performance of each contributes to the final expression of value.

The influence of engineering job size on PD flow and overall performance has yet to be characterized. Job size in engineering means the amount of effort required to complete specified deliverables. In a project environment where PD is usually undertaken, the work breakdown structure (WBS) provides a framework through which the expected deliverables of a project are specified. The project management body of knowledge (PMBOK, 1996) defines the WBS as a deliverable oriented grouping of project elements which organizes and defines the total scope of the project. The term job refers herein to the lowest, most detailed specific project component level of the WBS that defines the work to be delivered. Size refers to the quantity of effort required to complete the work to be delivered. Guidelines must be provided as to what constitutes a better job size under a lean engineering PD environment. A discrete event simulation model is developed to help ascertain the influence of factors, such as job size, multitasking, concurrency, average charge size, etc. on lean engineering PD performance, as well as a novel analytical economic design job quantity (EDQ) model to determine the optimal design job size, leveraging key factors from the DES.

The usefulness of this research is thus in developing a model to predict PD process performance, as well as in providing guidelines to industry, in terms of the most appropriate job size in PD. Such work, ultimately enhancing flow of information in PD, is required according to Browning (2000), Oppenheim (2004), Taylor (2005) and Reinertsen (2007).

This research also develops a novel taxonomy of post-certification engineering activities, as a first step towards true lean product development (PD). Relying on the key notions developed in a novel lean engineering performance model, a comparison of the leanness of post-certification versus pre-certification tasks is performed for the industrial project, and the lean engineering performance model validated.

Finally, multi-attribute engineering task value models are developed as well as associated resource allocation optimization models. The models are developed considering Browning's (2000) proposition that the value in PD is information, and that the goal of lean in PD is to improve the flow of information. The models provide the foundation for enhanced PD performance, and the establishment of optimal PD process policies.

1.2 Objectives and Scope of the Dissertation

The context of PD in the aerospace sector is one of intense competitive pressure. To ensure the continued competitiveness of this industrial sector in Canada, enhancing the productivity of PD is an urgent necessity. In this section, a summary of three important open research questions is provided, and then used to define the objective and scope of the dissertation. Figure 1 provides an illustration of key characteristics of the PD system to be studied in this research.

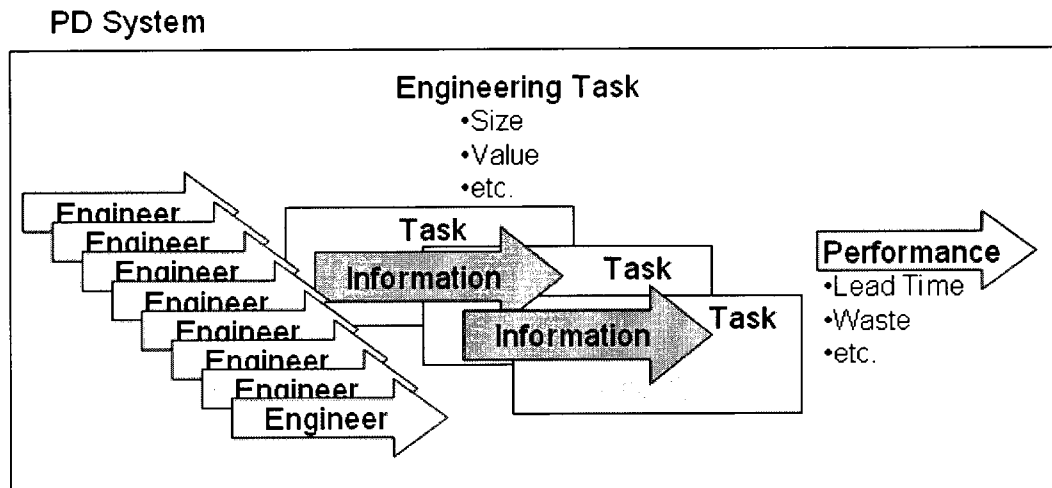

Figure 1. PD system elements

The PD system considered in this research transforms information with more or less concurrency, and is comprised of a number of elements, including engineering tasks, engineering personnel dedicating their time to more or less tasks at the same time (focus), with its output characterized by a performance level. Engineering tasks are characterized by their size (effort) and value. Performance measurements in the PD system measure flow in terms of lead time, as well as waste and other metrics.

Multi-Criteria Lean Engineering Performance Model. Scholars (Browning, 2000; Oppenheim, 2004; Hines, 2006; Reinertsen, 2007) and industry leaders alike have expressed the opinion that the most important factor to improve in PD is the flow of information. Finding ways to accelerate the flow of information will lead to more timely feedback, less inventory and rework waste and, according to Browning (2000), improve value to the customer via enhanced PD process performance. Taylor (2005) pointed to the “lack of a clear and workable financial model to measure the cost of current operations and potential financial benefit of lean improvements across the value chain” as

one of the weaknesses of existing lean techniques. His observation about the situation of a UK supply chain is also applicable to PD engineering activities, given the lack of a lean engineering PD performance model (observed later in the literature review). A lean engineering performance model is required to help ascertain the influence of job size on the flow of information. Therefore, the first objective of this dissertation is:

1. To develop and validate a lean engineering multi-criteria performance measurement model, that will support the lean goal of improving the information value flow in PD by reducing span time.

The first part of this research fills a gap in the existing published research by providing a common ground on the basis of which engineering organizations interested in productivity, efficiency and effectiveness improvement will be able to measure their engineering PD performance in a lean environment, and guide their efforts towards an ideal future state. The multi-criteria lean performance model thus constitutes a key pillar of this research as illustrated in Figure 1 above, and provides a basis for understanding the influence of a number of factors including job size, charge size, number of people involved in the job, number of jobs processed in parallel, and so on, on PD performance.

Optimal Engineering Job Size. The influence of job size on inventory management, production planning and scheduling, and flow is well recognized in the manufacturing world (Silver, Pyke, Peterson, 1998). A similar understanding of the influence of engineering job size to PD process performance has to be developed. The need to determine an appropriately sized work breakdown structure is not a new; as such a desire has been previously expressed in the shipbuilding design domain (Storch, 1999).

As a decision variable and a management policy, job size can provide the rhythm that is required by the PD process (Oppenheim, 2004), and respect the existing constraints of a leveled workforce in the short term (Morgan, Liker, 2006). The performance of the PD process is influenced by a number of factors including engineering job size. Thus, as a policy decision factor, PD process performance can be optimized to account for a number of preexisting factors or conditions. Given the dynamic nature of these factors, a discrete event simulation is developed to assess the influence of job size on PD process performance, as well as an analytical model incorporating key factors.

How to establish such an optimal engineering job size is unfortunately not specified, thus the second objective of this dissertation is:

2. To develop a discrete event simulation approach and analytical model in order to establish an optimal engineering job size, leveraging the engineering performance model developed in the first part.

Engineering PD Value Optimization. An attribute of engineering tasks, in addition to size as shown in Figure 1 above, includes that of value. Decision-making about resource allocation to engineering jobs influences the flow of information and the value realized from engineering activities. In the PD context, Browning (2000) argues that lean is not minimizing cost, cycle time or waste, but maximizing value. Multiple definitions of engineering job value have been proposed, for example in the construction industry (Georgy, Chang, Zhang, 2005a), or in the software industry (Ngo-The, Ruhe, 2009).

Engineering management is concerned about deciding how to best allocate limited resources to the multiple PD tasks they face. A model to optimize the scheduling of employees with multiple skills has been proposed (Chan, Hiroux, Weil, 2006), while a difficulty to expertise factor has been used to adjust the effort prediction for an engineering job (Bashir and Thomson, 2004), which is particularly interesting when not all resources share the same level of proficiency. A linear integer modeling approach has been used to determine the optimal mix of features for software release, coupled with a meta-heuristic to develop adequate resource plans for the strategy created in the first phase (Ngo-The, Ruhe, 2009). In some cases, the use of meta-heuristics would be inappropriate, inasmuch as such a problem can be solved via exact optimization methods (Talbi, 2009). This leads to the third objective of the thesis:

3. To develop lean decision-making models to support optimal allocation of PD resources, addressing the information value flow improvement to reduce span time.

A pictorial representation of the scope of this research is provided in Figure 2 below. The engineering sizing job model (ESJM) consists of the development of an analytical approach to determine optimal engineering job size, the development of a multi-attribute task value assessment model to determine which jobs to allocate resources to, the development of a discrete event simulation model to gather data on various PD system conditions, and the establishment of a lean engineering performance model to evaluate the system performance under various settings. The sequencing of jobs in the yellow box is not in the scope of this research, in part due to the absence of available

network precedence data for the case company, and is left for future researcher to investigate, while the blue box represents case company input into this research.

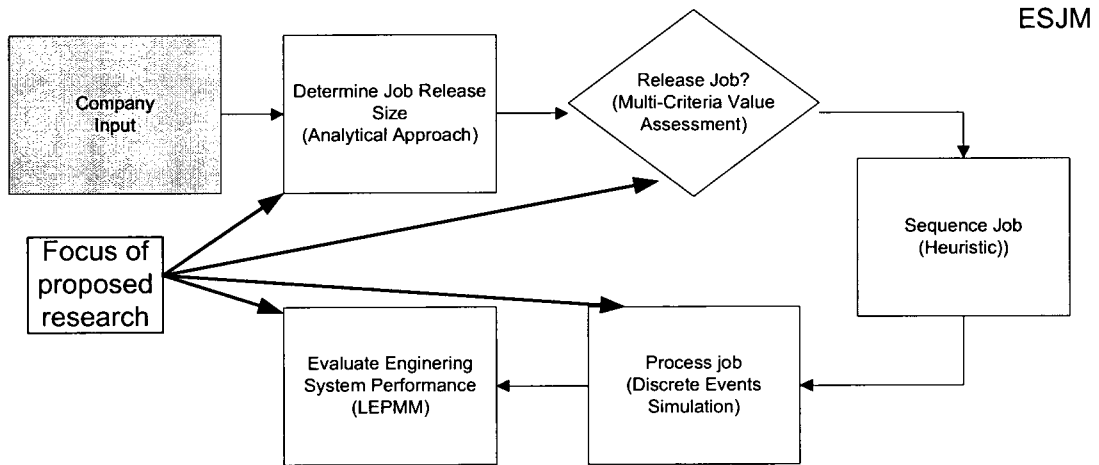

Figure 2. Research scope

1.3 Thesis Outline

The organization of this dissertation is in accordance with the goals expressed in the previous section. Chapter 2 provides a relevant literature review of the lean philosophy, in manufacturing as well as in PD. Chapter 3 to 5 are concerned with each of the respective research objective of this thesis, namely, a multi-criteria lean performance model, optimal engineering job size, and engineering PD value optimization problems.

Each of the chapters is organized to stand on its own, beginning with a literature review, presentation of the model(s), results obtained, together with a comprehensive discussion of the most significant findings.

In Chapter 3, a multi-criteria lean performance model is developed for the PD environment. An engineering taxonomy is developed, and the model is validated by

comparing the performance results obtained from pre- and post-certification value streams, respectively.

In Chapter 4, the use of an analytical approach as well as discrete event simulation (DES) is illustrated to determine the optimal engineering job size for the industrial problem studied. Substantial data gathering and descriptive statistic effort is undertaken to feed the DES. Design of experiment is conducted to ascertain the influence of the variables examined, and the model is explained.

In Chapter 5, a multi attribute model is developed to promote decision maker consistency for resource allocation to PD tasks. Multiple resource allocation optimization models are then developed, and results presented and discussed.

Chapter 6 provides a summary of the contributions and the findings from this dissertation. It also examines the scope of the research work, the objectives that were set to be accomplished, and brings additional research topics for future examination.

2. Background and Literature Review

This chapter provides support information required to enhance reader's appreciation of lean philosophy. In the first section, the importance of the lean multi-criteria performance study in PD is discussed. Then, in the following section the lean manufacturing principles are introduced, as well as the emerging lean engineering principles. Next, a review of the lean engineering performance measurement literature is performed, followed by a review of the engineering job sizing literature. Finally, a summary of the findings of prior, relevant multi-criteria lean engineering performance problem research is provided.

2.1 Importance of a Multi-Criteria Lean Engineering Performance Study

With challenging economic conditions, introducing and implementing new approaches to help management improve the performance and value delivered by their organizations are more critical than ever. Developing innovative ways to help organizations understand, measure, manage and optimize the work of individuals involved in complex 'white-collar' activities, such as aerospace PD, is not an easy task (Aral, Brynjolfsson, Van Alstyne, 2007).

As is the case in regulated industries such as aerospace, PD efforts must proceed through different pre-determined phases towards a key milestone represented by the granting of certification from regulatory authorities. From an operational standpoint, improving flow of information generated by the engineering tasks represents a key

objective to improve PD performance (Browning, 2000; Reinertsen, 2007; Oppenheim, 2004; Hines, Found, Griffiths, Harrison, 2008).

New product development is a critical factor in the long term success of technology oriented businesses (Wang, Perkins, 2002). A multi-criteria lean performance study will provide assistance to businesses interested in improving their PD operations.

2.2 Literature Review

In this section, a history of lean manufacturing is presented, followed by a review of lean engineering, lean engineering performance measurement, and engineering job sizing.

2.2.1 Lean Manufacturing

Starting in the mid 80's with research focused on understanding the drivers for Japan success in the automotive industry (Clark, Fujimoto, 1988; Womack, Jones, Roos, 1990), lean has attracted much interest from the aerospace industry to help address the opportunities for increased efficiency and effectiveness, with teams of researchers synthesizing the lean practice of a number of Japanese companies that was led by Toyota.

Lean is a term that has been first used in the 1990's at MIT to describe the Japanese production system, where use of less effort, space, and material resulted into higher output and quality (Murman, Allen, Bozdogan, Cutcher-Gershenfeld, McManus, Nightingale, Rebenstish,, Shields, Stahl, Walton, Warmkessel, Weiss, Widnall, 2002).

The five well known principles of lean manufacturing (Womack, Jones, 2003) are defining the value from the customer standpoint, identifying the value stream, removing barriers to work flow, enabling customer pull and promoting continuous improvement.

While these principles have been widely adopted by a number of organizations through the availability of specific implementation guidelines (Rother, Shook, 2003), and a set of fourteen principles from Toyota (Liker, 2004), the deployment of the PD equivalent is just starting.

Lean is a term that has been used to describe the Toyota Production System (TPS). The TPS philosophy was first described as being based on the following key concepts: cost reduction through elimination of waste, and full utilization of workers capabilities (Sugimori, Kusunoki, Cho, Uchikawa, 1977). As a production system, TPS evolved from the mass production system that had been developed in the beginning of the 1900's in America by Ford (Womack and Jones, 2003). The mass production system approach was supported by the concept of work specialization and division of labor developed by Frederick Taylor. Some significant milestones associated with the TPS are provided in Figure 3.

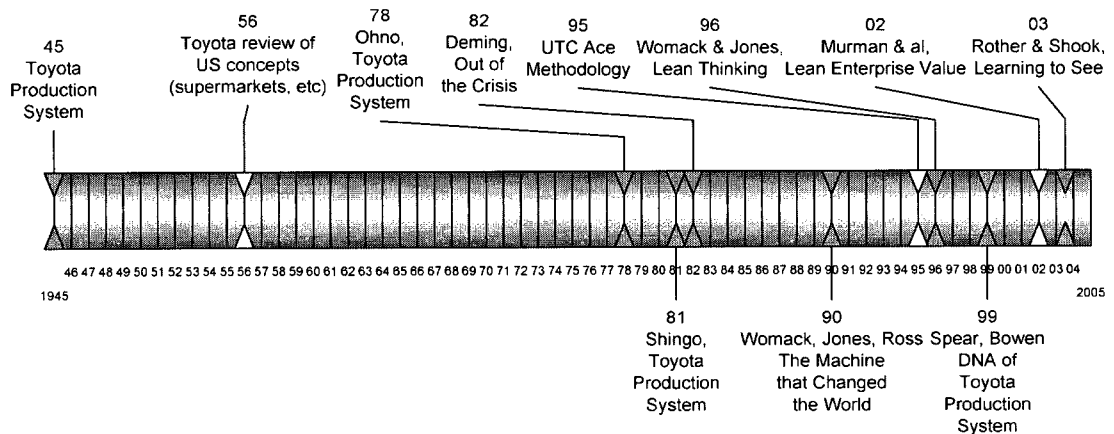

Figure 3. Key lean historical milestones (Murman et al., 2002)

Lean is not just about tools, nor is it systems of principles, metrics or value stream maps or customer satisfaction (Flinchbaugh, Carlino, 2006). Lean is not any one thing; lean is how everything works together. They describe lean as being at the heart of an operating system. This is a much more powerful view than the traditional one, as it integrates the previously offered formulaic definition of lean. An operating system is made of principles to align thinking and build culture, systems to process vital work, outline the way work gets done, and connect the organization, tools to generate new approaches and execute thinking, and evaluation to understand where the company is, against where it wants to be in the future.

Value is among the first principles defined (Womack, 1996). Value is a capability provided to a customer at the right time at an appropriate price, as defined in each case by the customer (Womack, Jones, 2003). Obviously, this would exclude waste or non-value added activities. They indicate that production activities can be classified in three categories: Value Added (VA) elements, Non-Value Added (NVA) steps, and Required Non-Value Added (RVNA) steps. The second principle requires that the value stream be identified. As mentioned earlier, Rother and Shook (2003) recommend using the VSM to achieve this. Their VSM approach is most useful for flow of physical goods, as it is mostly encountered in manufacturing. They propose using two states of maps, a current state representing the current reality of the organization, and a future state representing an ideal of what the future value stream will be. The value stream view provides for a pictorial representation of the third objective of the thesis, enabling flow. The third principle is to remove barriers to workflow. There are a number of suggestions, among others to produce to TAKT time, the maximum time allowable per piece to

manufacture goods such that demand is met, develop continuous flow wherever possible, use supermarkets to control production where continuous flow does not extend upstream, try to send the customer schedule to only one production process, create an initial pull by releasing and withdrawing small consistent increments of work at the pacemaker process, establish a management time frame, and develop the ability to make every part every day (Rother, Shook, 2003). Recommendations are also provided for creating continuous flow via the use of the design of cellular manufacturing systems (Rother, Harris, 2001). For the fourth principle, creating pull, the capability to create a level pull in the manufacturing organization needs to consider among others how demand is conveyed to the pacemaker to create pull (Smalley, 2004). The pull system is more reactive and apt to handle events occurring in the production environment and maintain process synchronization, as compared to a push system (AER07, 2007). Low barriers to workflow result in lower production lead times. The last principle involves striving for perfection. A number of alternative approaches to generating an ideal future state can also be considered. An approach called appreciative inquiry, with its four steps of discovery, dream, define and destiny, can be used to generate the vision of the ideal state and the steps towards achieving it (Cooperrider, Whitney, Stavros 2008).

2.2.2 Lean Engineering

Principles of lean manufacturing are well established and accepted, especially in high volume production environments (Lander, Liker, 2007). Lean in engineering remains a rather new phenomenon (Haque, James-Moore, 2004). Hines (2006) describes the context in which lean engineering applies, he describes lean as applying to engineering activities related to physical PD in two different contiguous stages. The

initial phase is described as new PD (NPD), and the latter phase as new product introduction (NPI). He defines NPD as comprised of the activities from the generation of the initial concept to the decision to commercialize the product. NPI is defined from NPD to the new product launch, commercialization, mass production and associated support.

The stages of PD are described as being comprised of planning, concept development, system level design, detail design, testing and refinement, and finally production ramp up (Ulrich, Eppinger, 2003). The previous model is expanded into the following high level approach for aerospace companies (Chase, 2000) in Figure 4 below, with progressively finer requirements evolving from the customer, to final hardware:

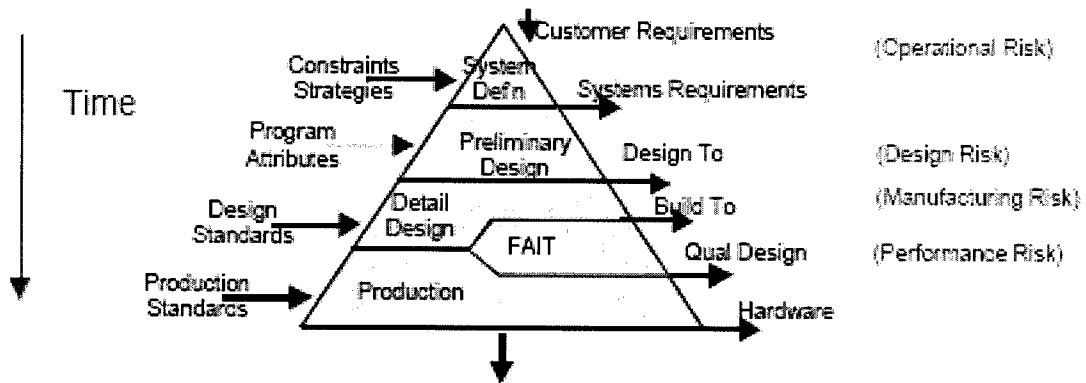

Figure 4. Aerospace PD stages – Chase (2000)

Defining what is value in PD is critical to the creation of lean in PD (Chase, 2000). However, the value definition used for manufacturing does not provide the needed specificity for PD, and is thus rarely helpful. A firmer definition of value is needed to optimize PD processes. Value can be defined from the perspective of the customer, shareholder, employee, end user or environment. Chase (2000) says that PD value can be reasonably assessed in terms of the information it creates, the product or

product packages they create, the smooth flow of the combined activities, or some combination of value inherent in these entities. Value can be defined as the ratio of performance (or quality of the above entities) over cost.

In the PD context, arguments are made that lean is not minimizing cost, cycle time or waste, but rather maximizing value (Browning, 2000). In an iterative processes like PD, getting the right information in the right place at the right time is the most important factor in adding value. PD is defined as the effort involved in the engineering development of knowledge about the product, or as a process of eliminating the uncertainty about the product. The following model in Figure 5 below defines value to customer in PD. Value to customer in PD is characterized by items such as process, product, quality and performance, affordability, and finally availability.

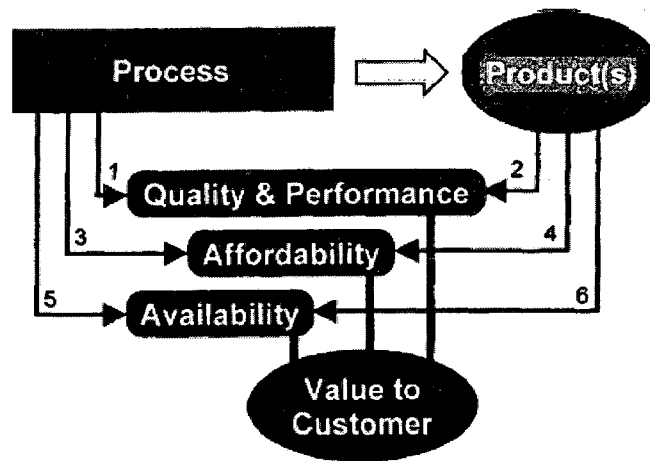

Figure 5. The factors related to value for a customer – Browning (2000)

The following high level objectives are proposed for lean engineering: creating the right product with efficient engineering processes and with effective lifecycle and enterprise integration (McManus, 2005).

Right Product/Job: Developing the right product is a basic requirement to start with, as all engineering and development effort that end up not answering customer needs or creating attractive market opportunities in the right products can be considered waste. The stage-gate process (Cooper, Edgett, Kleinschmidt, 2001) is a popular decision-making approach in the portfolio management domain (Womack, Jones, 2003). According to widely used project management standards (PMI, 1996), this decision making process persists until some time after the product is delivered, i.e., post-mortem reviews are conducted to enable propagation of lessons learned to future projects, and the new PD project is closed.

Improvements required in the fuzzy front end of product development (Wirthlin, 2000), in the period during which requirements are captured and alternative concepts generated are discussed. He suggests an idealized set of best practices and proposes a set of over 40 questions centered around the notions of requirements identification, concept development, enablers, process and business case to compare the current practice of an engineering organization involved in development activities versus best in class.

Efficient engineering Processes: Lean aerospace initiative (LAI) research suggests that to satisfy regulatory, safety and quality concerns, and allow for the management of complex aerospace systems, formal processes are required for almost all aerospace engineering activities (Murman, Allen, Bozdogan, Cutcher-Gershenfeld, McManus, Nightingale, Rebenstish, Shields, Stahl, Walton, Warmkessel, Weiss, Widnall, 2002). However, such processes are generally poorly defined, they refer to obsolete practices that are not relevant to most jobs, miss key practices, contain practices that have become irrelevant over time, and as a result are inconsistently followed.

An assessment of engineering time card hours results in a shocking 40% being pure waste, 29% necessary waste (i.e., setup or regulatory requirements) with only 31% being added value (McManus, 2005). Interestingly, McManus then states that tracked, work package jobs are idle 62% of the time, and only active 38% of the time. The combined value added and job active percentage is thus about only 12%. He then discusses Kaizen improvement events showing that 75% to 90% of job idle time is spent at the bottleneck process, hence the focus on scheduling the bottleneck resources. Indirect measurements of job idle time through a metric called Touch Time Ratio (TTR) (ratio of touch days divided by lead time) in company X supports the above, as the average TTR varies in the range between 10-25%.

In the present literature review, the notion of value in PD is consistent with the multi-faceted definition provided earlier and pictorially represented in Figure 5, particularly with respect to process value for the performance measurement model, and meant to ultimately represent “a capability provided to a customer at the right time at an appropriate price, as defined in each case by the customer” (Womack, Jones, 2003). In addition, the notion of value added can be ascertained from the activities that add value in the eyes of your customers (George, 2003), and thus measured using a number of ways, including for example time, as in value creating time on the value stream map time ladder (Rother, Shook, 2003). Value added can further be defined in opposition to waste related activities. Waste can be classified as non value added, or required non value added (Womack, Jones, 2003). Care must however be taken using this definition in an operational manner, as “Continue to decompose the VA activities, and activities of the other two types (i.e. non-value add and required non-value add) continue to appear.

Decompose ad infinitum, and the only thing left adding value (by the ‘three types’ definition of value add, non value add, required non-value add) is the final output materializing out of thin air!” (Oppenheim, 2004). Thus an operational definition of value in PD, based on different stakeholders, dimensions and criteria is required to address not only this important issue, but also support decision makers prioritization of various engineering tasks within the PD system. Another definition of waste proposed involves seven different components such as conveyance, inventory, motion, waiting, processing, overproduction, and correction (Morgan, Liker, 2006), Thus there are various elements that must be considered upon evaluating value, value added activities, waste, and the lean performance of PD as will be seen in the next sections.

Effective lifecycle integration: As stated earlier, in the lean enterprise, value is specified by the customer (usually captured through the voice of the customer approach, Quality Function Deployment (QFD), and flowed down using high level program deliverable objectives). Thus, the enterprise, as a going concern, must develop and offer in the marketplace products and/or services of sufficient value or features to justify their price. Given that 60-80% of product cost is outsourced to various supply chain partners, these firms must be involved early in the engineering of the product in a concurrent fashion so as to leverage their experience and ideas given costly changes that might be required otherwise, if key aspects of manufacturability or testability have been overlooked.

An effective PD project is one that “arrives at new and unique solutions that achieve the requirements/specifications of the project” (Kratzer, Gemunden, Lettl, 2008).

Lean Product Development Flow is defined as an organized effort of technological PD (Oppenheim, 2004). The author contends that this approach is required to address the need for improved productivity and quality of design, engineering, and manufacturing processes in the aerospace industry.

A number of problems are associated with the PD processes managed from a reengineering approach. Some of these include project management that has become too administrative, engineers spending only 20% of their time on engineering, design reviews that are largely ineffective, designs always started from an engineering perspective and not the result of real concurrent engineering including suppliers, minimal learning between projects, and design engineering personnel having little design experience, with inaccurate and unmaintainable scheduling systems, and with design decision loop backs that are too long (Kennedy, 2003).

The lean engineering principles as defined by the Toyota Product Development System (TPDS) (Morgan, Liker, 2006) provide for a set of thirteen guiding principles and philosophical framework for helping materialize the sought after engineering improvement in PD efficiency and effectiveness. The Toyota PD system does not exhibit the problems reported by Kennedy due to the use of knowledge based PD systems, set-based concurrent engineering, system designer entrepreneurial spirit, responsibility based planning and control, and expert engineering workforce. Toyota uses chief engineers that do not have direct authority, but derive authority from extensive experience and technical know-how, setting a number of integrative events where technical decisions are made with individual developers responsible for delivering their development projects. No large batch size PD seems to exist at Toyota. An expert workforce is developed by

organizing them functionally. The members join the PD effort only for as much time as needed. They report to supervisors selected for their technical expertise rather than managerial prowess. The primary role of supervisors in the functional organization is to enhance the expertise of their organization. Kennedy compares PD to a participative change methodology, where workforce develops implementation details in a succession of large integrative events. For PD, these events are launch, target and concepts, process approved, organizational system approved, system implemented. Such change methodology has been shown to be consistently successful. Adequate load leveling of the PD system is pointed as one of the key enablers to lean PD (Morgan, Liker, 2006). The use of properly defined and regularly scheduled integration mechanisms, as defined above, can provide the necessary focus on reducing delays and associated waste, and improving on time delivery of value by controlling the timing of integration events.

A recent study from the Massachusetts Institute of Technology Lean Advancement Initiative (Rebenstich, 2008) shows that there is no evidence that the maturity of lean PD implementation in aerospace is at more than an introductory level, with no enterprises being at the mature or accelerating levels. Among the many reasons believed to be contributing to this situation, a survey (Hoppman, Rebentisch, Dombrowski, Zahn, 2009) points out to the lack of prioritization, and underlying models to appropriately define value in support of resource allocation decision making in engineering PD activities, as a source of problem in implementing specific components of the TPDS.

Value in PD is also defined as "the right information product delivered at the right time to downstream processes/customers" (Walton, 1999). He indicates that

opportunities for improvement exist in cycle time, degree of product satisfying customer requirements, ease of production, and quotes benefits such as New Product Introduction cycle time down 30%, Post certification Engineering Change percent down 75 to 96%, parts reduction, First Article Inspection passed increased from 35% to 72% resulting from lean engineering implementation. He discussed the PD process, particularly the requirements generation and needs identified through marketing, and the ensuing required resource prioritization. He points out that requirements generation is the most influential step of development with respect to the eventual success of the program, as 85% of lifecycle cost is committed before the product analyzed entered full scale development.

Production Planning Preparation (3P) events, involving representatives from all members of the supply chain involved in the coordination and delivery of value in new product development, have been used successfully in simulating the physical flow of goods and information. These 3P events have become an instrumental tool in enabling an unprecedented level of production in the assembly of aircraft engines.

2.2.3 Lean engineering performance measurement

There is limited literature on lean engineering performance measurement for PD. Most of the published research for lean metrics refers to manufacturing. With this in mind, this section will review the available material for lean engineering measurement and multi-criteria performance models. A review of the most relevant research literature on lot sizing will then be presented, mainly in the manufacturing environment. Although some authors talk about the need for better management of engineering job size for PD, literature is scarce for engineering on this subject.

Authors point out to the “lack of a clear and workable financial model to measure the cost of current operations and potential financial benefit of lean improvements across the value chain” as currently being currently one of the weaknesses of existing lean techniques (Taylor, 2005). This observation about the agri-food supply chain in the UK exemplifies the situation that seems pervasive in lean engineering PD.

Given its strategic and competitive importance, much research has been done on the performance of organizations in the development of new products (NPD). Some studies highlight factors that have a significant relationship to NPD project performance, based on a review of published papers on the subject (Pattikawa, Verwaal, Commandeur, 2005). Predictive models of engineering performance in industry have also been proposed (Georgy, Chang, Zhang, 2005b). Performance evaluation of NPD using dimensions such as time (time to market, on time delivery), cost (total cost against budget, product cost) and quality (number of engineering changes request per project) are proposed from a company standpoint (Driva, Pawar, Menon, 2000b).

Semaan (2006) provides a review of the most commonly available multi-attribute evaluation approaches, including the multi-attribute utility theory (MAUT) and the multi-attribute value theory (MAVT). In the last two decades aerospace systems have become increasingly dependent on software to achieve expected mission capability (Srinivasan, Lundqvist, 2006). They identify the critical factors that make the aerospace software development and sustainment hard.

The focus of lean methods in engineering should be on creating faster flow, rather than eliminating waste (Reinertsen, 2007). Faster flow improves the feedback in design processes, enables innovation via a reduction of uncertainty and risk, and improves

efficiency by reducing wasted efforts. The author argues for the application of batch size reduction techniques and queue management principles to product definition, project funding, etc. He advocates transposing a flow solution from other domains that also exhibit high uncertainty in the PD environment. Given that lean in PD is about communicating information and learning, certain jobs must be handled with different priorities than FIFO. He finally argues about using a round robin approach for service type organizations, dedicating a portion of time to make progress on a number of tasks concurrently. How many such concurrent jobs (inversely proportional to TTR) should be allocated to these service organizations, and what about the core design functions that may also be waiting for feedback, would a mixture of high and low priority jobs improve the overall performance of the system, are some of the question to be answered.

Related to the principle of flow, arguments are provided to the effect that the same five lean principles as used in manufacturing can be applied to the large waste content inherent to PD with resulting savings yielding extraordinary benefits in terms of productivity (Oppenheim, 2004). He suggests that the use of lean engineering be limited to complex legacy based systems lasting less than 2 years with up to several hundred participants, using mature technologies, or simpler and smaller commercial and defense programs. In his framework he proposes using a large number of equal homework periods called takt periods, each terminating with an integrative event. The role is to provide a constant, common and frequent rhythm to the entire team. He suggests varying the number of allocated people depending on the effort assigned to the period. In practice, more flexible organizations and people with multiple engineering skills would be required to address this recommendation. Synchronizing the PD organization with

work packages of a relatively similar size would also address Oppenheim's proposal for improved flow.

For the second part, arguments are that value is added by PD in producing useful information (Browning, 2000). He adds that the value literature is poorly linked to the process modeling literature that recognizes the importance of information flow in the PD process. The purpose of many PD activities is to increase the certainty about the ability of design to meet requirements. He proposes a model of value made of 6 elements (process, product, quality and performance, affordability, availability, and value to the customer). He talks about the process architecture and its value trajectory, and suggests attacking the flattest part of the curve where there is long lead times with relatively little value added. He asks whether the deliverables can be produced in a more efficient manner with a new activity sequence, less iterations, a new approach, and new tools. He suggests that the process model illustrated in Figure 5 and value analysis can serve as the basis for management decision and a variety of process improvement analyses and business cases. Browning makes an implicit call for a detailed model to assess the performance of the PD processes. The model lists 6 areas for performance evaluation. The 6 are a mix of product and process. We have not seen anyone who has related product performance to process performance. We are now doing research on this. Not an easy concept.

A few models that assess PD performance in terms of value are identified (Chase, 2000). The value added method has been proposed (Higgins, 1998), where performance is measured in terms of the after tax operating income less weighted cost of capital. This model unfortunately cannot be applied to jobs. Given that the quality and efficiency of

activities determine the quality of the information produced and the time and money consumed, an appropriate understanding of the impact of job size variation on the PD process operational performance is required.

The impact of sequential versus concurrent engineering activities on design time and quality has been studied using simulation (Gebala, Eppinger, 1991). They indicate that the concurrent engineering approach leads to more iteration, albeit at a reduced cycle time.

According to some, the application of lean principles (eliminating waste) or tools such as value stream mapping to PD will never result into a PD system with the characteristics of Toyota (Kennedy, 2003). The gap between the state of PD in most companies and what is possible is just too great! He, however, encourages the use of lean concepts in continuous improvement efforts in the PD environments. One type of waste in engineering is to design, but never manufacture due to a late introduction to market. Thus, another performance metric that would be useful to consider in the current research is the percent of engineering jobs that are not introduced, and their relative value.

The importance of creating an optimized new PD process is highlighted by Narahari, Viswanadham and Kumar (1999), and it is indicated that lead time is an important performance metric for a development organization. The authors develop lead time models for PD organization that involve multiple, concurrent projects with contention for human/technical resources. Their objective was to explore how lead time could be reduced using efficient scheduling, input control, load balancing and variability reduction. Their model was based on single class and multi-class queuing networks, and

captured important facets of PD such as concurrent execution of multiple projects, contention for resources, feedback and reworking of project tasks, variability of new project initiations and tasks execution times. For PD, their focus was on product design.

As discussed above, there is general agreement about the value of PD expressed as a function of information produced on time to minimize wasted effort, and reduce uncertainty. Value is obtained in part from an efficient PD process that provides the right information on time, early enough to prevent wasted efforts and to reduce uncertainty. In practice, updates to design standards occur generally only towards the completion of the engineering job, as part of the standard work being performed. Thus, jobs with high effort content and high lead time do not have updated design best practices available for other jobs until a long time into the future, creating the possibility for more wasted effort to propagate in the PD system.

Haque and James-Moore (2004) define new product introduction (NPI) as the sequence of steps or activities that an enterprise employs to conceive, design and commercialize products and they indicate that limited work has been published in this area as well. The authors discuss the notion of required information being pulled from the person requiring it, and work performed in small batches, to decrease the lead time. They discuss the integration of activities rather than coordination. They also indicate that it is important to have an effective flow control mechanism to avoid a level of multitasking that affects the termination of the product in the time required. Key characteristics of an NPI process satisfy the 'flow of value' principles, comprised of the following elements: process and organization structure that focuses on improving integration of NPI functions as opposed to just coordination, effective program planning

and control, no excessive batching or buffering of information, effective communication and data flow of multifunctional information, effective flow of technology into projects. The key product of NPI activities is information. The aim is to reduce delays, process information in parallel wherever possible, continuously add information value as activities progress from one step to the next, and eliminate non-value added information.

Metrics used in a manufacturing job shop environment include profits and owner's compensation (% sales), labor cost (\$labor/\$sales), productivity (\$ sales/labor hour), average customer lead time (days), quoted customer lead time (weeks), on time deliveries (% of total orders), average lateness (days), inventory (months), inventory turns (turns per year), percent defective (surface defective/surface sold) (Lander, Liker, 2007). Previously mentioned balance sheet and income statement based metrics are similar to what was proposed earlier (Higgins, 1998), and appears to be of limited value at the engineering job level. Measurements such as average lateness (days), proportion of jobs delivered on time to required date (OTD), productivity (TPUT/CH), may be valuable indicators of performance in the context of PD.

The examination of design induced rework (Love, Edwards, Irani, 2008) leads to the observation that given the high rate of project cost and schedule overrun, a number of strategies for improving project performance have proliferated. They contend that a major factor at the source of this overrun phenomenon is design induced rework, manifesting itself in the form of changes and errors. They examined the factors mitigating errors, such as design audits, verifications and reviews before documentation is distributed. Appropriate staffing levels and levels of skill are required to perform these tasks.

Metrics commonly used in lean construction to gauge system performance are discussed (Arbulu, Tommelein, Walsh, Hershauer, 2003). They indicate that batching is an important consideration in the supply chain lead time performance assessment because bigger batches cause longer wait time and therefore longer lead time. They also suggest dedicating resources, because each switch of task comes with a setup cost, and multitasking extends lead time. Multitasking does reduce idle time, but does not necessarily increase productivity they contend. Multitasking reduces idle time by enabling a worker to provide effort on another task, but it may be better to focus on resolving the root cause forcing task switching, and the related increase in lead time. They also suggest that to obtain more reliable throughput, resources must be dedicated to particular tasks and have some excess capacity to buffer the anticipated variability in workload.

The authors introduce value stream mapping as a basis for analysis of the current state map, adopting a flow rather than activity perspective of how work gets done, including metrics to gauge certain types of waste. They indicate that waste is omnipresent in the construction industry, and that it often occurs at the interface between processes, disciplines or organizations. A theory of construction is provided, the so called Transformation, Flow and Value (TFV) theory. 'The crucial contribution of the TFV theory of production lies in calling attention to modeling, structuring, controlling, and improving production from these three points of view combined.'. The goal includes elimination of waste, reducing the share of non-value add activities, reducing lead time, reducing variability, simplifying by minimizing the number of steps, parts and linkages, increasing flexibility, and increasing transparency. The term process reengineering was

popularized in the 1990s by Hammer and Champy (2003) in the following rules: organize around outcomes and not tasks, have those who use the output of the process perform the process, subsume information processing work into the real work that produces the information, treat geographically dispersed resources as though they were centralized, link parallel activities instead of integrating their results, put the decision point where the work is performed, capture information once and at the source. The results of reengineering were mixed.

Lean design is defined as integrating the activities of production and product design to enhance competitive performance (Jayaram, Vickery, Droge, 2008). The key practices associated with lean design are in their opinion: concurrent engineering, design for manufacturability, value analysis, and standardization. In terms of metrics for performance measurement they propose using pre-tax return on assets, return on investment and return on sales. However, it is not clear how these high level metrics are directly affected by the lean performance of the organization, as there are many other factors potentially affecting these high level financial measurements. A similar issue was previously discussed (Higgins, 1998; Browning, 2000).

The use of a leveling factor index (LFI) is suggested to monitor lean process flow in ship production (Storch, 1999). The leveling factor index measures how even working times are for work within the manufacturing levels (this is a ratio of the finishing time of the previous process over the start time of the subsequent process). A total leveling factor index (TLFI) is derived from the LFI to provide for an overall measure of evenness of work block working times, and is defined as $TLFI = \sum |1 - T_i / T_{i+1}|$, where T_i are

completion and start times associated with two adjacent processes, with a value of 0 being the target.

As shown in this section, a significant literature gap exists for lean performance multi-criteria models in engineering. At the PD process level, there is an absence of such global approaches to quantify the benefits and costs associated with lean in PD. This situation thus provides strong motivation to propose additional research in this important field, and to integrate other dimensions of PD process performance as previously reviewed. Thus the focus of this research is to develop such multi-criteria lean performance model for PD. More specifically it is expected that the performance model will support this research focus on span time reduction in PD. Given the previously noted difficulties with the lean definition of value added, non value added and required non value added, and the desire to provide decision makers with a consistent basis for maximizing the value realized from the use of PD resources, an operational definition of value based on multiple dimensions and criteria will be established in the following chapters.

2.2.4 Lean engineering job sizing

Although some authors talk about the need for better management of engineering job size for PD, literature is scarce on how to support this objective in engineering; most of the published research for job size refers to lot sizing models for manufacturing applications. As previously discussed, the objective of lean in engineering is to create flow. The absence of flow manifests itself in terms of excessive inventory, and high lead time. There remains the question of how to reduce the engineering intellectual inventory work in process to achieve the important objective of flow. Some authors suggest

balancing workloads through appropriately sized and designed work break down structure (WBS), and corresponding resource utilization (Storch, 1999). He argues for a smaller size block of work versus conventional blocks to ensure continuous flow. He also mentions that the one important implication of the principle of continuous flow to be explored is the size, number and work content of the interim product

Mascitelli (2007) states that one of the most powerful ways to reduce waste and accelerate NPD is to prioritize the design team effort. He provides advice on a 3 tier schedule approach to planning projects: tier 1 with a rolling 3 month horizon, tier 2 with a rolling 1 month horizon, and tier 3 with a rolling 2 week horizon. He argues that any effective scheduling approach must incorporate milestones to track progress. Milestones represent both a point in time and a measure of value achieved. There are 2 ways of measuring progress, % complete through time spent, or deliverables that represent substantial amount of work. This advice is of practical interest to the engineering job size discussion.

A model is proposed to determine the optimal lot size in a production environment using M/G/n queuing (markovian (exponential) inter-arrival time distribution with general distribution of service time, with n servers) and optimization (Grewal, Enns, 2008). They consider a case of parallel machines and multiple servers, and assess the impact of single versus multiple queues in a multi-product environment. The interest in their approach is in the determination of an optimal lot size; however, their model does not take into consideration multiple stages or the influence of concurrence on rework. Also, they assess performance solely on lead time, while other measurements such as most of those discussed in this section are not taken into consideration. The

interest here is the utilization of queuing networks and optimization to derive optimal lot size. A model of a similar nature could be useful in assessing the lead time associated with a specific configuration of the PD process.

The use of a genetic algorithm using parallel job representation to solve a problem of the organization of execution of N jobs (n firm and n' predicted jobs) in an ordered operation multi-objective problem (MOP) of minimizing make span and production cost is suggested by Berkoune, Mesghouni and Rabenasolo (2006). They breakdown the problem into 2 phases; the first one is the assignment of each operation to an available and non-identical machine, while the second problem relates to the computation of a starting time to obtain a realizable schedule. They use coding to find possible insertion times for predicted jobs, and then calculate lower bounds for both cost and makespan to estimate the quality of the solution. The interest for their article is the transformation of the multi-criteria problem into a singular objective one via the use of weights.

A review of the key factors influencing front loading such as problem solving performance, and investigation of how to achieve superior problem-solving performance is performed by Gouel (2007). A portion of his work has been used as the basis for developing a decision tree for engineering pre-certification and post-certification classification work that is useful in assessing the relative performance of various types of engineering PD work (new centerline, derivative, and post-certification work).

Push, pull and CONWIP systems are described as effective production control policies (Zhang, 2007). Push refers to throughput controlled and WIP measured production system that control work release orders in which jobs are released on a start date based on due date minus a deterministic lead time, and are best exemplified by

material requirements planning (MRP) system; pull refers to shop floor WIP controlled and throughput measured shop floor control system outgrown from the Toyota production system where with the main objective to reduce work in progress (WIP), via the use of kanbans, and have evolved into just in time (JIT) systems; CONWIP, which stands for constant WIP, is a hybrid of push and pull production system featuring container that are pushed through a production line, with the number of containers controlled like kanban cards in a pull system (Sipper, Bulfin, 1997). He goes on to say that the CONWIP system is a hybrid of push/pull control policy, and was proposed for optimal work in progress (WIP) control. Number of containers, lot size and job sequence need to be addressed. He developed 2 linear models for make to stock or make to order environments that simultaneously determine the job sequence as well as lot size. A third model is developed for an assembly type CONWIP system where a determination of the number of containers (i.e., work package size) and job sequence is determined. This last model is developed via a heuristic search method based on simulated annealing (Zhang, 2007).

Key types of job priority due date quotation models, analytic models, empirical models, due date models with job information, due date models with both job and job shop information, non-linear due date quotation (DDQ) models, data mining based DDQ models are reviewed (Patil, 2006). He concludes that several factors such as scheduling rules, job characteristics, shop utilization level, shop size and complexity influence the performance of DDQ policies. Given the impact of job size on meeting due date, this study presents some interest.

Details about how Intel has adapted the Drum Buffer Rope (DBR) scheduling policy for their manufacturing systems, and identified a number of areas of research are discussed by Gilland (2001). A significant area of research is the decision process regarding when to release a new job on the factory floor (focus on analysis of tandem queuing systems). For systems with a single bottleneck, he shows that operating the system in a closed queuing network from the beginning of the process to the bottleneck provides better system performance than using either a closed queuing model for the entire process (CONWIP), or any static release rule. He explores the case of multiple bottlenecks and discovers that a release rule that simultaneously considers the number of jobs before both bottlenecks significantly outperforms rules based on either bottleneck independently. He also studies the sequencing of jobs in closed queuing networks with the objective of minimizing server idleness, translating into higher levels of throughput.

Detailed project planning is highlighted as one of the key factors influencing the success of concurrent engineering in accelerating development (Kara, 2000). He develops a probabilistic simulation model fitted to the precedence relationships to estimate project completion under uncertainty. In addition, he develops a new multi-project heuristic to address the problem of resource constraints in multi-project concurrent engineering environment. He concludes that his simulation model meaningfully predicts project completion time under uncertainty. The multi-project scheduling heuristic performs better than the traditional ones in terms of minimizing the project completion time and optimizes resource utilization. The issue with this approach is that in practice, engineering jobs are not planned with such consideration of

precedence; they currently appear to be more like manufacturing lots being pushed in a MRP context.

The above literature review did not reveal any work available in the area of models for best PD engineering job size. Proponents of the Toyota Production System (TPS) indicate that the use of increasingly smaller lot size to improve flow in the manufacturing area is critical in helping see barriers to flow, and develop appropriate countermeasures to remove the associated waste. The absence of existing engineering job size models thus provides strong motivation to study the influence of job size on the performance of the engineering PD system.

2.3 Summary

Key gaps resulting from the literature review include the unavailability of models for best PD job size, and the absence of lean multi-criteria performance models for PD process. These gaps need to be urgently addressed to provide reasonable answers to the challenge created by the emergence of low cost manpower in developing countries, and the need for improved competitiveness of Canadian companies. Arguments for appropriately sized WBS to ensure information flow are provided (Storch, 1999), but there is nothing specific about how to establish such a job size. A number of authors suggest focusing on improving information flow; however, they do not investigate in detail how varying job size in PD could enable this (Reinertsen, 2007; Browning, 2000; Hines, 2006; Oppenheim, 2004). Oppenheim is most specific in how to achieve information flow; unfortunately, his proposed approach of varying PD work force in each period to ensure constant rhythm of deliverables faces practical business limitations. The optimal manufacturing lot size determination approach proposed by Grewal and Enns

(2008) unfortunately does not capture the multi-dimensional nature of PD process performance. Taylor points out the need for models to ascertain the benefits derived from lean. With value obtained in part from an efficient PD process that provides the right information on time, early enough to prevent wasted efforts and to reduce uncertainty, waste in this thesis refers to the non-value added efforts in PD. Most of the PD performance literature reviewed is either from a high level business standpoint, or their constructs are not of a predictive nature. In the next chapter, a multi-criteria lean engineering performance model is developed to address Taylor's concerns. Then in the following chapter discrete event simulation and analytical models are developed to ascertain the influence of job size on span time, and establish optimal PD job size. Finally in the next chapter the operational notion of value for PD is developed, in conjunction with medium term mono-period and multi-period resource allocation models for optimized realized value, and engineering earned effort, and short-term resource allocation engineering throughput optimization model.

3. Multi-Criteria Lean Engineering Performance Model

In this chapter, a lean engineering performance measurement model is developed that provides the ability to study the influence of a number of criteria and management policies such as job size on the performance of the product development value stream. In the next section, the rationale for the development of such model is provided. In the following section, a background review is offered. Then, the mathematical model is developed with associated nomenclature described. A post-certification engineering taxonomy is developed, and results from benchmarking of pre- to post-engineering value stream is presented, and then discussed. A conclusion finally summarizes this chapter.

3.1 Motivation

Achieving productivity improvement in engineering organizations involved in product development is a daunting and complex task, commensurate with the complexity of the products being designed. The introduction of a lean multi-criteria performance measurement model provides assistance with the move away from viewing product development as “a creative and unmanageable effort to one that is viewed (and managed) as a repeatable and standardized business process” (Wang, Perkins, 2002).

From experience, the difficulty in introducing changes to complex engineering and design systems such as the ones discussed above resides less with the understanding and integration of the concepts themselves, but rather with their acceptance and use in an appropriate manner. A lean engineering performance measurement models is required to study the influence of a number of criteria on the PD value stream, benchmark the relative performance of various value streams, and support their improvement via specific

actions taken to resolve the noted opportunities for improvement. Benchmarking exposes participants to new ideas, provides a sense of urgency to continuously improve and to be aware of best practices (Beitz, Wieczorek, 2004). Once certification is obtained, some activities may remain. In the post-certification phase, i.e., after granting of certification from authorities) tasks of a different nature compete for limited post-certification engineering resources.

Although a number of different and useful classification schemes have been proposed for engineering activities, such as software configuration management (Conradi, Westfechtel, 1998), system engineering technological uncertainty and system scope (Shenhar, Bonen, 1997), and consideration of environmental issues in design (Rounds, Cooper, 2002), no equivalent has been found for the engineering post-certification activities occurring in aerospace PD.

The novel, lean engineering financial performance model described in this chapter offers a coherent approach to PD performance measurement, and supports lean promises of a more efficient engineering organization with reduced lead time, waste and improved customer and shareholder value. Overall, a new framework for measuring lean engineering performance is presented.

3.2 Background

Metrics are important factors driving behaviors of individuals and shaping their organization to such an extent that the firm becomes what it measures (Hauser, Katz, 1998). It has been argued that organizational transformation drives the creation of new metrics, which is itself fueled by the firm's burning platform strategy, developed on the basis of the firm's strength, opportunities, weaknesses and threats (Blackburn, Valerdi,

2009a). Although the balanced scorecard approach is popular in many industrial firms (Kaplan, 1983), its application in the PD domain appears to be less widespread, with the consequence that engineering and design personnel are relatively unfamiliar with the profitability goals of their employer (Sandstrom, Toivanen, 2001).

Understanding new product project performance constitutes a laudable goal being pursued by many organizations and individuals, given the importance of both human and capital resources devoted to them. To help achieve a heightened level of understanding of what are those key variables that have a significant impact on new product project performance, a number of studies have been conducted over the years. Their major limitation however relates to the limited availability of such data given its competitive nature, and the heterogeneity of whatever data is available (Pattikawa, Verwaal, Commandeur, 2006).

A review of performance measurement systems shows that they can be classified into structural, procedural, or both categories. A familiar example in the structural framework is a value stream mapping (VSM) approach, a very popular method in lean applications. An example of a procedural family is the six sigma DMAIC approach, whereas the balanced scorecard approach is classified in both the procedural and structural categories (Blackburn, Valerdi, 2009b).

A number of case studies have been provided to show how the introduction of lean has resulted in a renewed process management focus, influencing the performance measurement system (DeToni, Tonchia, 1996). In a detailed review of the specific metrics used in an implementation of a performance measurement system in an aerospace firm, an illustration of the effectiveness of using performance metrics in a design

organization to improve its competitiveness highlights areas requiring improvement, which increase the organization focus on customer needs, is recently provided by Buchheim (2000). Another study undertaken from the project management side concludes that the implementation of a performance management system for product development is a very challenging task, given the difficulty to measure the level of effort, and the uncertain future outcome of these efforts. The lack of a generally accepted management approach in this domain is also pointed out, and the study of a military aircraft performance measurement system implementation project is discussed (Chiesa, Frattini, Lazzarotti, Manzini, 2007).

Academic institutions have contributed to this field by developing PD performance measurement methodologies for manufacturing organizations through field case studies, acknowledging the fact that only until recently the only consistent measurements were those made from financial statements (Driva, Pawar, Menon, 2000a).

Their main question was ‘how do companies know that they are making effective use of their product design and development activities?’ The PD metrics surveyed show that cost and time are the most important measures, whereas the lack of quality measures in product development is explained by the difficulty to measure this in product development. The top five measures used by surveyed companies were total cost of project, on time delivery of development project, actual cost of project compared to budget, actual versus planned time for project completion, and lead time to market. The top five metrics that these companies wanted to introduce in the future were the number of bottlenecks in the design and development process, the number of design changes to specifications, the number of design defects detected at the design and development

stages, the percent of project time spent in meetings, and the development cost of products that do not make it to market (Driva, Pawar, Menon, 2000b).

It has been argued that the difficulty with measuring product development projects successes and failures relate to their multi-faceted nature in terms of contribution to customer satisfaction, financial return, and technological advancement. A firm's strategy needs to be taken into consideration when developing appropriate metrics for these product development projects, noting that the set of metrics for a project by simply extending a product line versus one creating an entirely new market would be different. Firms that place little emphasis on innovation need to focus on measuring the efficiency of the development program, whereas an innovative firm needs to measure the project contribution to company growth. Customer satisfaction and market share are often cited metric for project success (Griffin, Page, 1996).

Achieving NPD objectives on budget is still a dream, as pointed out by Bashir and Thomson (2004); only 26% of projects in the United States are completed on time and within budget. Meeting budgets is becoming increasingly important in civil aerospace, given the intensifying competitive pressure firms face and shareholders' expectations for return. Current profitability and net cash flow of aerospace engine manufacturers may be affected in the short term by the uncertain R&D expense inherent in these complex development programs, whereas future cash flow and profitability depend on an uncertain initial sales volume estimate. Fortunately, academics, industries and governments have joined efforts in the last few years and produced abundant ideas, tools and approaches to help provide the much needed improvements in this exciting field, such as the ones from the Lean Aerospace Institute (LAI).

However, one of the weaknesses of lean techniques is the 'lack of a clear and workable financial model to measure cost of current operations and potential financial benefit of lean improvements across the value chain (Taylor, 2005). To support productivity improvement in the engineering NPD system and direct efforts in the most needed directions, a novel lean engineering multi-criteria model is described next. Previous studies reviewed did not address the systemic measurement of performance improvement to be derived from a lean implementation in PD, but rather covered discrete measurements at the task and project level only. Thus, the need for a novel integrated lean engineering performance measurement model is fulfilled in the next section.

3.3 Lean Engineering Performance Measurement Model

Let us now examine a lean engineering business model that compares key dimensions of engineering jobs outputted either in aggregate or at the individual level to some previously established baseline, at specific points in their lifecycle in the engineering system. As pointed out earlier (Taylor, 2005), it is difficult to assess the benefits of lean without such models, as the changes taking place are more of an evolutionary and gradual nature than those resulting from a drastic reengineering of operations. For example, waste reduction of 5% could hardly be felt by anyone, as it would represent only two hours of a person's time for a forty-hour work week.

This type of model, like any regular enterprise system, is run every month to capture previous engineering system status and provide a high level view of the progress achieved towards throughput improvement, waste elimination and lead time reduction. It starts by capturing the number of jobs, n , completed at some pre-determined stage of their lifecycle in a given time frame. Job completion is determined through confirmation of

specific activities in the Work Breakdown Structure (WBS). For each such completed job, the evaluation of job lead time is performed by comparing the date of the first hour charged to the date of the last hour charged.

In a similar fashion, the total amount of hours charged on each completed job is the sum of charged hours within that activity. The evaluation of average job lead time is performed together with the average charged hours using the above values.

$$\overline{LT} = \sum_{i=1}^n (F_i - S_i) / (1.4 * n) \quad (1)$$

for $i=1, \dots, n$ jobs, where \overline{LT} is the average lead time per job, F_i is date of last hour charged, S_i is the date of the first hour charged, and $i=1, \dots, n$ represents the number of completed jobs during the period of interest. The factor of 1.4 is required to convert lead time durations from a seven day per calendar week basis to a 5 day per working week basis.

$$\overline{CHRS} = \sum_{i=1}^n \sum_{j=1}^m CHRS_{ij} / n \quad (2)$$

for $j=1, \dots, m$ days, for all k nodes, where CHRS represents the hours charged on job i during lead time by any node (or employee) k .

Based on an assessment of whether anyone has been charging more than a given threshold of hours on a given day on a specific job, each lead time day of a given design job is coded as either a touch day TD or alternatively a non-touch day NTD. This means that if, according to the rule below, sufficient focus has been put on the job to have it progress, that day can be considered a day that helped progress the job towards completion, using a pre-determined threshold such that if more than two hours is spent during a day by at least one employee, then that day becomes a TD for that job.

$$\overline{TD} = \sum_{i=1}^n \sum_{j=1}^m TD_{ij} / n \quad (3)$$

where $TD_{ij} = 1$ if $CHRS_{ij} \geq 2$, for any node k, $TD_{ij} = 0$ otherwise

$$\overline{NTD} = \overline{LT} - \overline{TD} \quad (4)$$

where \overline{NTD} represents the average number of non-touch days.

The average number of nodes is simply the average of the number of employees that have been charging each design job:

$$\overline{N} = \sum_{i=1}^n N_i / n \quad (5)$$

where N_i represents the number of employees that have been charging to job i.

The number of hours delivered corresponds to the average hours previously discussed multiplied by the number of jobs completed in the chosen period.

$$HRD = \overline{CHRS} * n \quad (6)$$

where HRD represents the number of hours delivered.

The touch time ratio is the ratio of touch days to lead time. It effectively enables an evaluation of the effectiveness with which the lead time is used, with a low touch time ratio potentially indicating possible improvements in the flow of information and resulting reduction of waste.

$$TTR = \frac{\sum_{i=1}^n \frac{TD_i}{LT_i}}{n} \quad (7)$$

where TTR is the touch time ratio metric that was previously discussed. The reduction of waste referred to above is justified considering that days with no charges above a given

threshold to a specific job not only do not contribute much to advancing that job, but also contribute to stopping the flow of other jobs, as engineers attending the other jobs stop working on those. Also by the definition offered from Equation 12 below, all charges on NTD are considered wasted setup, on the basis that NTD charges do not contribute significantly to advancing the jobs. Finally note that each time there is a change of job occurring, a small amount of effort is required to setup for the new job (intellectual, paperwork or computer). Thus one could argue that the amount of resource required to complete a job using lower charges would be higher than that required using larger charges, all other things equal, and the more of job switching there is, the more there is waste generated. In addition lower charges would also increase LT, intellectual work in progress (IWIP), associated carrying cost.

The (IWIP) provides a snapshot of the level of intellectual inventory for jobs that have not yet been incorporated into a product (i.e., active jobs). As an example, the longer the lead time period during which the average engineering job is progressing, but not yet completed, the larger will be the amount of IWIP.

As for a regular supply chain, the following relationship holds:

$$WIP = T * L \quad (8)$$

Commonly called Little's Law, we can see that a larger lead time L generates a larger amount of WIP, with throughput T. From this model it is obvious that to reduce the amount of WIP, one has to decrease the average job lead time (or increase the TTR).

As in the case of production, reducing levels of inventory in the intellectual engineering process is important as the funds released from inventory reduction due to

faster order to cash cycle can be used in a much more profitable manner delivering additional value to customers and shareholders.

$$IWIP = \sum_{i'=1}^{n'} \sum_{j'=1}^{m'} WHRS_{ij'} \quad (9)$$

where IWIP represents the total amount of intellectual work in progress at the end of a given period, and $WHRS_{ij'}$ gives the work in progress hours for an active, non-completed job i' , provided by employee j' .

Next, the calculation of the percentage of waste improvement is performed. Based on experience and a subjective evaluation, and confirmed with focus group discussions, two hours of setup are allocated to each person that charges to the job (nodes).

$$\overline{SETUP} = 2 * \overline{N} \quad (10)$$

where \overline{SETUP} represents the average setup time, and \overline{N} represents the average number of nodes that have been charged to the job. Setup time is real, and companies active in product development endeavors in the civil aerospace sector absorb these charges that reduce their profitability. Better information flow and consideration of available capacity would help since a person would continue to work on a job rather than being forced to switch.

Another two hours of restart is added for each person that had a period of more than two weeks of inactivity on a given job, and comes back charging to the job after this period.

$$\overline{RSTRT} = 2 * \sum_{i=1}^n \sum_{j=1}^m RSTRT_{ij} / n \quad (11)$$

where $RSTRT_{ij} = 1$ for any non-overlapping period of 10 days or more without charges from node k on job i, 0 otherwise.

Finally, the sum of hours charged on non-touch days are aggregated and averaged under the nomenclature of wasted setup (in the sense that these were not sufficient hours to significantly advance the job; thus, the time charged was probably wasted).

$$\overline{WSETUP} = \sum_{i=1}^n \sum_{j=1}^m CHRS_{ij} * (1 - TD_{ij}) / n \quad (12)$$

where \overline{WSETUP} represents the average wasted setup.

Adding the 3 categories of waste above and dividing by the average charged hours provides for the percentage waste.

$$\overline{WPCY} = 100 * (\overline{SETUP} + \overline{RSTRT} + \overline{WSETUP}) / \overline{CHRS} \quad (13)$$

The percentage waste improvement is simply the difference between the baseline and year to date (YTD) percent waste values.

$$\overline{WPCI} = \overline{WPCY} - \overline{WPCB} \quad (14)$$

where the \overline{WPCB} is the waste percentage baseline, a value that has been established through an analysis of the engineering system over previous periods, and \overline{WPCI} represents the waste percentage improvement.

YTD throughput improvement hours result from the comparison of prorated baseline throughput hours to year to date cumulative value.

$$TI = T_Y - T_B * (M / 12) \quad (15)$$

where T_Y is year to date throughput and T_B is baseline throughput, M is the month, and TI represents the throughput improvement.

The main dimensions of lean engineering savings include lead time reduction, throughput improvement, waste reduction, and finally reduction of inventory of intellectual work in progress (IWIP). All savings calculations use an hourly engineering rate R.

Lead time reduction is composed of two main components, the first one being a reduction in carrying cost for intellectual inventory resulting from the reduction in non-touch days. As indicated before, carrying intellectual inventory requires financing, as the potential revenues from selling the inventory will not be generated until some later time period, although employees are getting paid for every moment. Thus, the concept of weighted average cost of capital (WACC), or more simply carrying cost (cc) can be used to determine the magnitude of the financing required for the intellectual inventory. Components of WACC include items such as cost of equity, cost of borrowing, risk levels, etc.

$$LTR_{NTD} = cc * M * (\overline{NTD}_B - \overline{NTD}_Y) * IWIP * R / 12 \quad (16)$$

where $\overline{NTD}_B, \overline{NTD}_Y$ represent the non-touch days for the baseline and year to date periods respectively, R is the hourly rate over which the carrying cost cc is applied, and M number of time periods year to date.

The other portion of the saving results in the value of a one time output differential resulting from a lead time delta from a prorated baseline.

$$LTR_{LT} = R * (\overline{LT}_B - \overline{LT}_Y) * TI \quad (17)$$

where \overline{LT}_B and \overline{LT}_Y represent the baseline and year to date lead time respectively, and LTR_{LT} is the saving associated with a reduction in lead time. Note that TI is the throughput improvement calculated earlier.

$$LTR = LTR_{NTD} + LTR_{LT} \quad (18)$$

As mentioned earlier, LTR , the lead time reduction, is made up of two components, a reduction arising from a decrease in non-touch days, and a reduction arising due to a reduction of lead time impacting throughput.

Intellectual inventory reduction is carried on a three month rolling average basis with the reduction arising from the differential of carrying cost between baseline and year to date IWIP figures.

$$IR = cc * R * ((IWIP_B * M / 12) - IWIP_Y) \quad (19)$$

where IR is the value of the inventory reduction, $IWIP_B, IWIP_Y$ represent the baseline and year to date amount of intellectual inventory.

Waste reduction is calculated as:

$$WR = \overline{WPCI} * HRD_y * R \quad (20)$$

where WR is the waste reduction calculated as the waste percent improvement times the hours delivered to date (HRD_y) times the applicable hourly rate.

Finally, throughput improvement is calculated as 50% of the difference between a prorated baseline throughput and the year to date.

$$TS = 0.5 * TI * R \quad (21)$$

Lean savings are simply the sum of the above savings.

$$LS = LTR + IR + TS + WR \quad (22)$$

3.4 Post-Certification Lean Engineering Taxonomy

Although much effort is spent focusing on timely delivery of quality products within budget in the pre-certification phase through approaches such as project

management and system engineering, it is not unusual for further engineering resources to be spent in the post-certification phase (i.e., after granting of certification). As a result fewer new product development endeavors can be funded given the limited overall PD resources available.

The lack of classification schemes for post-certification activities makes it more difficult to consistently explore and compare the cause of post-certification work across programs, and as a result address and resolve potentially recurring engineering issues. To shed some light on the nature of these activities, a novel post-certification taxonomy and decision tree is developed in this chapter, and findings from a lean engineering performance benchmarking study are shared in the next section, with post certification improvement potential characterized by comparing the performance of pre-certification versus post-certification tasks. The benchmarking study uses the lean multi-criteria performance model developed in the previous chapter, and compares two PD value streams in terms of key lean performance parameters, including waste, lead time, and touch time ratio within the company.

The research in this thesis was applied at a company, the name of which will remain undisclosed and will therefore hereinafter be referred to as the case company. The case company is a multi-national corporation active in the design, manufacture and service of aerospace and industrial engines in the civil general, regional, business, aircraft segment, as well as helicopter and military markets. The study has been performed over a period of four years, Much data has been obtained from the company project management cost collection system (SAP P/S), while other data has been obtained during multiple workshops involving many dozens of participants from the company, as well as

from multiple one on one discussions with company representatives. Deep knowledge of the inner operation of the PD system has thus been gained from the many thousands of hours spent at the company, from discussions with colleague researchers in multiple international conferences, as well as from the intense effort spent as a lean engineering researcher capturing data and knowledge, developing code and analyzing trends, and designing models to test various approaches susceptible to improve the efficiency and effectiveness of the PD system. The company's stage-gate PD process is shown in Figure 6 below.

The pre-certification tasks are those that occur in the first four phases, given type certification granting from certification authorities is required prior to shipment of production engines to customers. Tasks occurring past the fourth phase are generally thought as non pre-certification tasks. However, to ascertain in a consistent fashion whether these tasks are of a post-certification nature, or otherwise, a decision tree is needed.

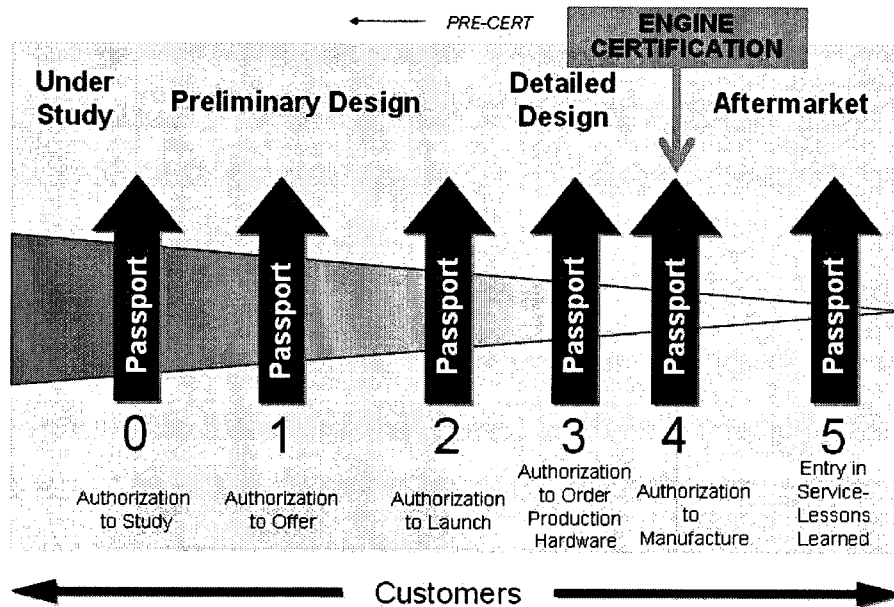

Figure 6. Stage Gate Process

The novel post-certification taxonomy is developed to help ascertain the source of post-certification work and to ensure consistent classification of engineering PD tasks. The classification scheme of engineering tasks is influenced by factors such as the origin of need, clarity and completeness of requirements, effectiveness of PD process delivering expected performance level, and compliance to engineering PD best practices standards.

As shown in the taxonomy in Figure 7, PD tasks are classified into the following 6 categories, according to the above-mentioned factors: pre-certification, product repositioning, product improvement, post-certification, new learning/best practices, and quality. The pre-certification category involves activities occurring before granting of type certification from governmental authorities. The product repositioning category involves considering adding new requirements to the product specifications, for example changing material to allow a different use (e.g. aerospace to industrial use). The product improvement category as the name implies involves modified requirements, for example

changing materials to allow increased thrust level. The post-certification category is used when the initial requirements are met, and involves for example cost reduction or re-sourcing activities. The new learning category involves a new design that does not meet the current requirements, but previously complied with old design standards that were in force when the design was conducted. Finally the escape category reflects the waste induced in unnecessary rework due to deviation from standard state of the art design practice. Significant engineering rework waste causing a miss in target latches a DIVE (Define, Investigate, Verify, Ensure), the case company 4 step continuous improvement approach that is essentially similar to Deming's plan-do-check-act (PDCA) cycle. For example, a task that originates, in time, after type certification has been obtained, and that is not the result of a new requirement, nor of a modified requirement, and where it can be determined that the initial requirements were met, would fall into the 'post-cert' category. Cost reduction engineering tasks would generally fall into this category as well as support to production tasks.

In addition to gaining a better understanding of the source and improvement of the way in which additional expenses generated by post-certification engineering activities are addressed, the taxonomy of post-certification engineering work is used in this research. The goal of the taxonomy is to categorize engineering tasks into various groups in order to assess their relative performance in the context of the industrial research project conducted on the PD value stream.

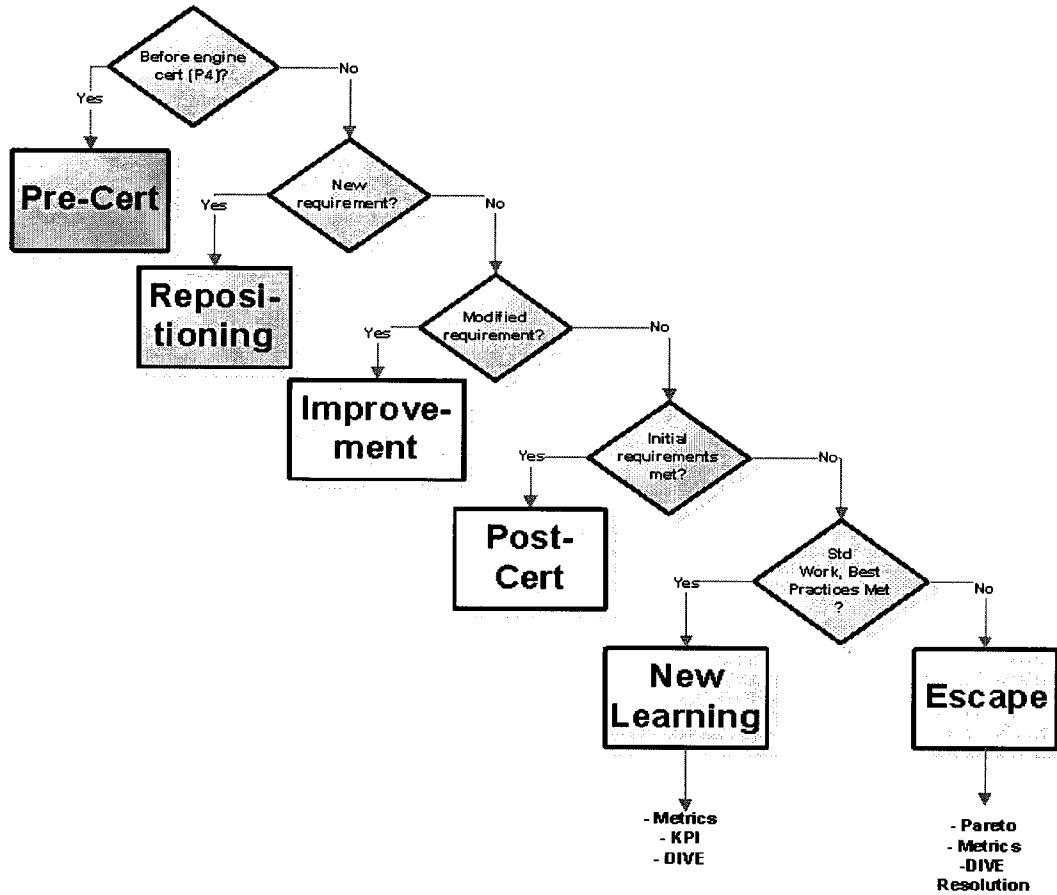

Figure 7. Post-Certification Taxonomy and Decision Tree

3.5 Benchmarking Results

Note that other value streams in addition to those reported here have been extensively analyzed with over 5.9 millions hours of time card charges captured from diverse engine families and engineering groups. However, due to the competitive nature and confidentiality of these results, the case company management has requested that these detailed results not be shown in the thesis. Table 1 summarizes historical data covering more than ninety thousands time card charges generating over three hundred and sixty-two thousand hours have been analyzed for the selected pre-certification value

stream. Similar analysis for the selected post-certification value stream covered more than five hundred thousand time card charges generating over seventeen hundred thousand hours (number of charges >0). A similar time frame has been used to collect data for both types of tasks (period covered). An examination of tasks created over an extended period after the granting of type certification resulted in more than forty percent of the tasks being classified into the post-certification category. With the more consistent PD environment found in pre-certification PD projects, and the high frequency of tasks categorized in the post-certification category, it was decided to compare the relative performance of post-certification tasks to that of the pre-certification tasks. Key lean engineering performance benchmarking metrics comparing pre-certification and post-certification task performance have been evaluated using the previously discussed lean engineering multi-criteria performance model. As indicated in Table 1 below, more than two million engineering hours charged to these projects have been analyzed (total hours charged), for over 70 tasks (number of jobs studied). Comparisons were made within the same product family. As can be seen from the data in Table 1, there are significant differences between the value streams. Focus, which represents the ability of engineering personnel to dedicate their time to more or fewer tasks at the same time, is calculated as the ratio of value stream hours over total hours (ratio jobs studied total hours charged over total). Results for job duration, waste and intellectual work in progress (IWIP) are discussed next.

Table 1: PD performance metrics benchmarking

Data collected	Pre-cert	Post-cert
Type		
Period covered	2006.09-2008.09	2006.03-2008.11
Total hours charged	362,693	1,747,105
Number of jobs studied	61	13
Average job size (hours)	888.9	1037.8
Total number of nodes	83	275

Descriptive Statistics	Pre-cert	Post-cert
Number of charges > 0 hour	90,605	508,485
Average Charged hours	4.0	3.4
% charges below 2 hrs	52%	47%
Charged hours at 63.212% of Cumulative Density Function	3.2	2.0
Total hours charged on studied jobs	54,223	13,491
Total # charges on studied jobs	8,055	3,765
Ratio job studied total hours charged over total	14.95%	0.77%

Lean engineering performance metrics(*)	Pre-cert	Post-cert
# Jobs completed	58	3
Average studied job duration to date (working days)	139	249
Touch days	59	94
Non touch days	79	155
Average TTR	0.42	0.38
# Nodes	5	42
Setup hours	580	252
Number of restarts	78	4
Restart hours	156	8
Charged hours on non touch days	1297	498
Total wasted hours	2033	758
Throughput * (hours)	52936	3425
Waste (%)	4%	22%
Intellectual work in progress (%)	2%	75%

*: Lean engineering performance metrics calculated on completed jobs

Detailed explanations of Table 1 results are given in the following section. Figure 8 shows the results obtained from the benchmarking exercise. There is evidence that the pre-certification engineering environment is leaner than the post-certification one, according to the lean engineering performance metrics of time to task completion, and intellectual inventory (using Little's law relation), even when adjusted for an average effort differential of twenty percent higher for post-certification.

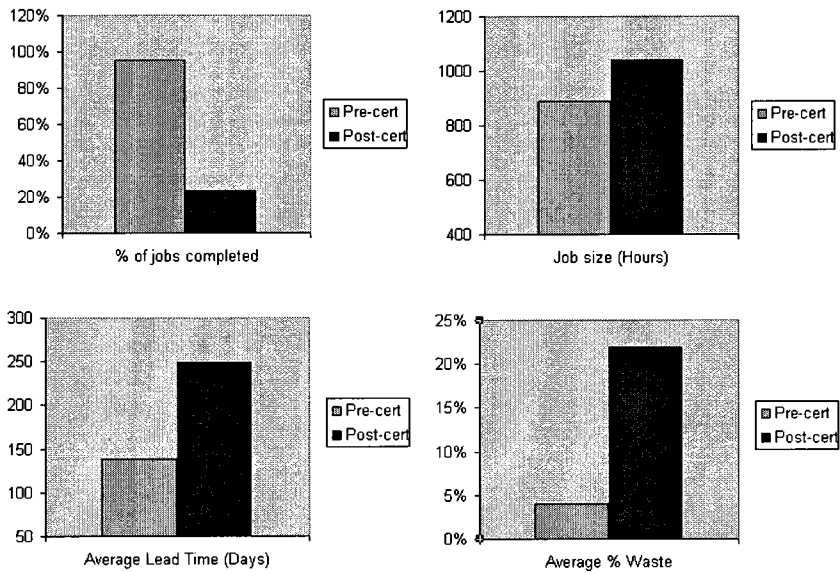

Figure 8. Key Metrics Benchmarking

From a lead time (LT) standpoint, the post-certification environment requires on average eighty percent more time to complete a task (average studied job duration to date working days). Waste involved in post-certification activities is almost six times higher than in the pre-certification environment (waste %). The total number of nodes (i.e., employees) involved in the thirteen task post-certification value stream is over three times more than that in the sixty-one task pre-certification value stream (# nodes). The post-certification value stream studied has on average twenty percent bigger tasks than the pre-certification one (average job size hours). In a similar timeframe of over two years (period covered), about twenty percent of the post-certification tasks were completed versus over ninety-five percent for the pre-certification ones (# jobs completed). Note the large difference of focus in Table 1 between pre-cert and post-cert value streams, with focus (i.e., inverse of multitasking) of employees working on pre-

certification tasks at about seventeen times higher than that for employees working on post-certification tasks. Comparisons were made within the same product family to minimize unnecessary variance.

3.6 Discussion

Within the case company, engineering procedures have been established for this novel taxonomy for more than a year now, with much consistency in engineering task classification gained as a result of its use. The major use of this classification tree is to control and report budgetary adherence to the executive management of the corporation for engineering expenditures on tasks classified as “escape”, those tasks that emanate from after the granting of type certification from authorities, and are not the result of a change in requirements, nor a lack of meeting initial requirements, and where best practices have been met. In essence, these tasks constitute rework waste or redo, and can be considered muda, as resources required to undertake these are not available to other engineering activities.

It is noteworthy to mention that the same taxonomy has also been implemented at the parent American company. However, while classification of engineering tasks is early in the process in the case company used in this research, with much follow up on the cost of the engineering tasks in the “escape” category, the American implementation of the taxonomy only reports the task in the escape category towards the end of its lifecycle, when almost all the investigative work is completed. This timing difference in classification of tasks generates a significant delta in terms of yearly cumulative expenditures reported, with the American approach being much more conservative in this respect. Harmonizing the report timing of the companies’ respective approaches should

be an objective that is pursued; so, worthwhile comparisons can be made with as valuable and encompassing data as possible.

Also the determination of root cause for the engineering tasks classified under the “escape” category is not systematically carried out. There appears to be some opportunities to institute processes to make this a more systematic outcome within the classification process. Expected benefits would include the determination, and fixing, of recurring causes for such engineering waste.

The following paragraphs discuss the rich engineering value stream performance information found in Table 1. The top portion of the Table 1 contains information about data collected. Engineering time card data for two engineering value streams have been collected. The value streams belong to the same family of product; for the first column a pre-certification value stream, and for the second column a post-certification value stream. The data collection was conducted in three phases. The selection of the product family value stream of interest is discussed briefly in Appendix 1, and was modulated by completion of a significant portion of the engineering work, as per discussions with the various design and project engineers. Upon selection of the product family value stream, and focus group discussions, a list of engineering jobs associated with that product family was generated. In a second phase, the case company project information system was queried, and as indicated in Appendix 2, all charges associated with the jobs of interest were captured. The last step involved the capture of charges on all other jobs and activities from all employees that had time card charges on the selected tasks for the product family value stream of interest.

The product family selected for the lean engineering multi-criteria performance model validation is one of relative youth. To minimize unnecessary variations that could be introduced by the analysis of data from different time periods, care was taken to collect data for post-certification tasks that were started in a similar time period as for the pre-certification value stream. The computer code contained in Appendix 2 was used to generate the descriptive statistics and lean engineering performance metrics found in Table 1.

The pre-certification value stream is leaner than the post-certification value stream. In support of this assertion, let's examine two key lean engineering performance metrics, namely lead time, and percentage waste, as follows:

1. Lead Time, or average studied job duration to date (working days) as reported in Table 1, represents the average lead time of tasks completed. This lean performance metric is calculated as per Equation 1. The value of lead time reported in Table 1 shows a marked difference, from an average of 139 days for pre-certification jobs, to 249 days for post-certification jobs. The post-certification engineering tasks take much longer to complete. Discussions with case company personnel highlighted factors which might explain this situation, among which the fact that pre-certification tasks are more repeatable from one project to the next, and driven to hard dates, generally driven by customer and certification deliverables, while post-certification tasks appear to be more internally focused to the case company, and generally less anticipated and repeatable.

2. Waste percentage is another key lean performance metric. Waste percentage is defined in Equation 13, and includes items such as setup, restart, and wasted setup. The waste percentage calculated for the pre-certification value stream is at 4%, while the metric for the post-certification value stream is at 22%. As can be derived from Table 1, there are two main contributing factors to the higher waste percentage observed on post-certification value stream. The first one is the fact that there are more people charging on average to post-certification jobs than to pre-certification ones, thus driving higher setup. The average number of nodes, as defined in Equation 5, is at 5 for the pre-certification value stream, compared to a much higher value of 42 nodes per job on average for the post-certification value stream. As a result, the value for total setup hours defined in Equation 10 is at 580 hours for the 58 pre-certification value stream jobs completed, while the value for the same metric for three post-certification jobs completed is at 252 hours. While it may seem from the above values that the post-certification value stream has lower setup, it must be noted that the denominator of the waste percentage is based on charged hours of completed jobs, which is much higher for pre-certification (at 52,936 hours) than post-certification (at 3,425 hours). In turn this is thus driving a lower percentage setup for the initial component of percentage waste in the case of pre-certification value stream. The other key contributing factor to the higher waste percentage observed on the post-certification value stream relates to the notion of

wasted setup, defined in Equation 12. While average job size in Table 1, as defined in Equation 2, is fairly similar for pre-certification value stream and post-certification value stream with values of 888 hours and 1,037 hours respectively, the higher lead time on post-certification value stream discussed previously, combined with the higher number of nodes observed for post-certification, combine to produce a PD environment where efforts appear to be less focused or dedicated to the post certification value stream specific jobs. This relative absence of focus, a phenomenon initially observed in the post-certification PD value stream, has been quantified in Table 1 under the heading "Ratio job studied total hours charged over total". As the name implies, it is calculated for a specific value stream as the ratio of studied jobs total hours charged, over all hours charged from value stream employees, for the time period studied. For example the pre-certification value stream focus level of almost 15 percent is calculated as the ratio of the total hours charges on the 61 value stream jobs of 54,223 hours over the 83 employees total charges in the time period of two years of 362,693 hours. It can also be observed that the less focused post-certification value stream produces more non touch days, as defined in Equation 4, with 155 non touch days for post-certification value stream on average, versus 79 for the pre-certification case. The higher non-touch days in turn drive wasted setup, as defined in Equation 12, such that all charged hours on non-touch days are accumulated under this waste category. In table 1 the charged hours on non touch days amount to 1,297

hours for the pre-certification value stream, and to 498 hours for the post-certification value stream. Again, care has to be exercised when comparing these numbers, as the waste percentage is evaluated on the basis of charged hours on completed jobs. In sum then, comparing value stream performance with the same average job size, a higher number of nodes drives higher setup, and higher lead time for same effort drives higher non-touch days, which in turn drive higher wasted setup.

With key results of Table 1 appropriately explained, the notion of validation of the lean engineering multi-criteria performance model is discussed next. The following arguments are provided to support the very good validation that has been performed of the multi-criteria lean engineering model, in addition to the results already shown in the previous section:

1. With external consultant support, specific engineering jobs were selected and "shadowed" with all information transfers mapped over their life, as well as effort and duration. All information transfers were coded in terms of type of waste, rework, etc. Maps depicting the physical flow of information were produced, as well as maps showing the information handoffs between nodes. The initial phase of this exercise was completed in a few months.
2. Interest in the multi-criteria lean engineering performance measurement approach started from the significant engineering work measurement effort described above, initiated in part to understand the source of delays, and improvement opportunities for engineering related work.

3. The performance model high level elements were initially established, operational notions to support the key elements gradually defined and refined, and agreed with executive management, as a way to report, and more importantly quantify, engineering performance improvement.
4. A pilot has initially been conducted on a key portion of the engineering business selected on the basis of the local management willingness to participate in the experiment, the potential benefits to be gained by the customer organization hosting the experiment, as well as on the basis of the executive management level of interest and support for a pilot experiment.
5. The pilot experiment objective was to validate, on a small scale, the influence of alternative engineering organizational arrangements addressing the improvement opportunities noted in the shadowing exercise (delays, opportunities for improvement).
6. The pilot validation was initially performed in a design department through a test case where a flow line approach for post-certification jobs was used to create a small cellular arrangement of engineering personnel (design, drafting, static analysis, configuration management) and the lean performance of this cellular arrangement compared to the lean performance of the regular silo function organizational arrangement for "post-certification" engineering jobs, using the multi-criteria lean engineering performance model.
7. The lean engineering multi-criteria performance model has been instrumental in demonstrating the difference of performance between the alternative

organizational approaches (cellular arrangement versus silo/functional arrangement).

8. Significant benefits in terms of lead time reduction, and touch time ratio improvement were observed (by a factor of five to eight times for TTR from post cert to cellular arrangement). On the soft side interviews and discussions with the employees in this experiment also indicated a higher degree of satisfaction with their work environment, in part from better visibility of upcoming work, improved communications, and reduced frustration from constant switching of task priorities.
9. Upon demonstration of the feasibility and viability of the lean engineering model, and significant achievement demonstrated above, case company executives began to demand yearly financial improvement targets for their engineering organization.
10. With these requests the lean engineering multi-criteria performance model usage began spreading into other areas of engineering.
11. At the same time a significant training of engineering personnel took place, explaining key notions of the performance measurement model through simulations, exercises and games.
12. Later on the lean performance model was independently verified by case company internal finance representatives, and found to adequately report the performance improvement claimed.

13. The lean engineering performance model is now fully implemented at the case company, and used on a monthly basis to establish the performance of engineering against previous year baseline.

14. Significant engineering performance improvements have been measured through use of the model, and all objectives met, or exceeded.

On the basis of what is mentioned above, the validation of the lean engineering multi-criteria performance model is considered very good.

In addition the lean engineering multi-criteria performance comparison performed in this chapter provides substantial and decisive evidence to support the opinion that the evaluated value streams are operating at different levels of performance. The key lean engineering performance metrics generated in this research for lead time, waste and throughput show that the post-certification environment is not as lean as the pre-certification one. Much effort has been required to improve the quality of data available in the case company, such that lean engineering performance metrics could be generated in an acceptable manner. The lean engineering multi-criteria performance model is now implemented and yielding the desired results. The presence of a silo approach to engineering management, and the absence of a value stream based management organization, might be a contributing factor to this situation.

To address these opportunities for improvement, a reorganization of the company's engineering activities is underway with specific project management value streams created for research and technology, NPD, operations, and product management (PM), that are aligned with passport zero, one and two, three and four, and five respectively.

3.7 Conclusion

In this chapter, a multi-criteria lean engineering performance model has been developed. In addition, a taxonomy to classify engineering tasks occurring after the granting of type certification from governmental authorities has been developed. Deployment of the taxonomy in the industrial research project company for an extended period of time has shown that a high percentage of engineering tasks are classified into post-certification.

The lean engineering performance model was deployed as well, and used to compare the performance of a post-certification value stream to a pre-certification value stream. Engineering tasks were selected from similar project family and timeframe to ensure comparability. Computational results provided evidence that the pre-certification environment is a leaner one than the post-certification one. Following these results, the company is reorganizing its product development value stream into four distinct entities, including a NPD value stream for pre-certification work, and product management value stream for post-certification work.

Given that these models were not only developed, but also deployed in industry, much insight has been gained from using them. Further improvement opportunities should be possible as the new value streams are created, and their corresponding performance gets measured and compared to the other ones.

Overall this chapter provided a foundation for consistent classification of engineering tasks, and enables the evaluation of their respective value stream lean performance, in accordance with the lean continuous improvement principle.

4. Optimal Engineering Job Size

In this chapter, the use of an engineering job sizing approach to further improve the performance of the PD engineering system is examined. The motivation for investigating an engineering job sizing approach for PD system is provided in the next section. Then, some background on the application of job sizing techniques is presented. Next, the proposed engineering PD job sizing approach through an economic order quantity calculation and discrete event simulation (DES) is described. The following section discusses the design of experiments, set up of simulation, and computation of results process. Then, results are provided, and discussed in the next section. A conclusion is finally provided in the last section of this chapter.

4.1 Motivation

Scholars (Browning, 2000; Oppenheim, 2004; Hines, 2006; Reinertsen, 2008) and industry leaders alike have expressed the opinion that the most important factor to improve PD is the flow of information. Finding ways to accelerate the flow of information will lead to more timely feedback, less inventory and rework waste, and improve value to the customer via enhanced PD process performance (Browning, 2000).

Lot sizing constitutes a basic pillar of inventory management, production planning and scheduling in manufacturing industries, and has a profound impact on a firm manufacturing cycle time, and thus, on its ability to deliver products quickly and with reliability to their customers (Silver, Pyke, Peterson, 1998). Although much effort has been expended in manufacturing organizations over the years to establish the economic order quantity (EOQ) (Harris, 1990) and the economic production quantity

(EPQ) (Szendrovits, 1975) for their supply chain and manufacturing operations respectively, and to eventually reduce lot size to the unitary level goal set by the lean philosophy, there is unfortunately no equivalent approach established yet for PD.

In the PD domain, convincing arguments have been presented for an appropriately sized engineering job, including reduced estimation error, clearer ownership, enhanced progress control, easier network construction, and improved cash flow for contractors. Some organizations propose guidelines in terms of effort or duration with respect to engineering job size (Raz, Globerson, 1998), but unfortunately an appropriate framework to establish such an optimal size is lacking (Storch, 1999).

In this chapter, a novel economic design quantity (EDQ) analytical approach based on minimization of cost to establish the optimal engineering PD job size is developed. The focus will be mainly on administrative costs, the influence of the level of concurrency between various phases of the PD system, the impact of the engineering level of focus or its reciprocal multitasking, and considering the rework associated with concurrency. This is followed by a discrete event simulation (DES) model, developed to study the influence of engineering job size on the dynamics of the PD system, and the impact of increasing the number of jobs in the PD system on its lean engineering performance, using the model established in the previous chapter.

4.2 Background

A prior section of this dissertation provided a literature review on job sizing models with contributions mainly from the manufacturing domain. In this section background of prior research on optimally sized jobs with potential applications to the engineering PD domain is conducted in order to provide an appropriate perspective of the

research contribution from this chapter. Finally, a review of discrete event simulation (DES) application in the field of PD is provided.

Work on post-certification activities can represent a sizeable portion of the engineering budget. Early detection of problems in PD is less expensive than late detection (Wirthlin, 2000). Accordingly, much research has been done on identifying factors that can help to improve the PD front end (Walton, 1999). Excessive load on resources in the upfront design can lead to problems in later stages of product support (Repenning, Gonçalves, Black, 2002), as well as to an exponential increase in the queuing time for tasks (Smith, 2007).

4.2.1 Optimally Sized Jobs for Engineering

To begin, with, some terminology and definitions are in order. In this research, the terms job, task, or work package are used in an interchangeable manner. Work packages are defined as a deliverable at the lowest level of the work breakdown structure (WBS), and may be further divided into activities (PMI, 1996). The WBS represents the work content of a project in a hierarchical fashion. The WBS is defined as a deliverable oriented grouping of project elements which organizes and defines the total scope of the project with each descending level representing an increasingly detailed definition of a project component (PMI, 1996). Thus, work packages are important in representing the scope of a project, specifically in terms of ability to plan, execute and control a PD project.

Academic activity in the area of optimally sized engineering jobs has been relatively limited. Only a few authors have been making reference to this subject

(Storch, 1999; Raz, Globerson, 1998), but unfortunately no quantitative method has been proposed on how to establish such size.

A number of elements are provided in support of the importance of appropriately sized work packages (Raz, Globerson, 1998), including the fact that work divided into smaller, homogeneous elements help achieve focus (of engineers actually performing the work), and provide for an improved basis of estimation for future similar work packages to be completed. In addition, the estimation error for cost and duration is reduced by use of smaller work packages, assuming there are no systematic bias and independence of work package estimates.

Sizing of work packages needs also to consider ownership, such that the person or unit who is assigned the work package can deal with most or all of its content. Progress control such as that required in earned value management system (EVMS) is also influenced by the size of the work package, as it is easier to control progress on jobs completed than to estimate the percentage completion of jobs that are not completed yet. As the number of jobs defined for the project increases and granularity improves, there is a corresponding higher performance measurement precision that must, however, be balanced with the additional administrative effort of raising and following more jobs.

Interdependent activities should be assigned to the same work package, and to the same extent activities that cross work package boundaries should be allocated to the appropriate work package to facilitate network construction, where precedence relationships exist. Another point to consider upon in building the work package is the internal cohesion and includes items such as organizational responsibility, required resource, timeframe for execution, starting conditions and exit criteria.

Then, consideration of the influence of work package size on the cash flow situation of contractors is appropriate, given that payment is usually dependent on the completion of some deliverables defined as work packages. Finally, risk management is influenced by the way work packages are defined, as well as the corresponding mitigation plans, so not only size, but also content of work packages matters.

Although the research on optimal task size in the PD domain is relatively scarce, the manufacturing domain has on the other hand benefited from a wealth of research. Of much interest to this thesis is the work done for multi-product lot streaming manufacturing environments, which is reviewed next.

The multi-stage economic production quantity model (EPQ) assumes that a constant lot size is manufactured through several operations with setup between each successive step (Szendrovits, 1975). It allows for sub-lots to be started during the next operation while the remainder is being completed in a previous step. The main advantage of this approach is to reduce the manufacturing cycle time by allowing a concurrent or combined movement of material rather than a sequential one. Demand rate is constant and continuous over an infinite horizon in the EPQ model. With greater production rate than demand, inventory accumulates and is depleted in the next period of production inactivity. The economic production quantity is achieved when the average work in progress and finished goods inventory cost, plus fixed cost per lot, are minimized. The model assumes constant fixed cost per lot and linear inventory carrying cost.

In the case of the multi-product manufacturing environment, much research has been devoted to developing the best sequence and best sub-lot allocation, under a number of performance criteria. There are three main approaches that have been used to solve the

multi-product, multi-lot streaming and sequencing problem, namely the analytical method (exact or optimization approach), the heuristic method (genetic algorithm), and the experimental method (simulation) (Chang, Chiu, 2005). Unfortunately, these manufacturing models do not take into consideration the multi-tasking nature of engineering work found in PD, and neither does it consider the influence of concurrency on the extent of rework. The proposed economic design quantity model (EDQ) will address these important issues. Next, a brief literature review of applications of simulation to resolve the PD job sizing problem is presented.

4.2.2 Discrete Event Simulation

Discrete event simulation (DES) enables the consideration of different factors and policies that would otherwise be difficult to tackle from a purely mathematical standpoint. To help ascertain the influence of factors such as the level of multitasking, concurrency and average task size on PD LT and waste, a model is developed to simulate company system requirements, software development and validation portions of a pre-certification PD value stream.

DES has been used extensively in manufacturing areas among others to understand the influence of various parameters on performance, and to help in the selection of the best configuration for a system under evaluation.

As suggested in the theory of constraints (Goldratt, Cox, 1992), an adequate appreciation for the whole production system is often required to realize true improvements. Despite the application of proven improvement methodologies such as lean, or six sigma, improvement efforts often fail to yield the desired results. Discrete event simulation has been used for many years to understand the dynamics of complex

production systems, support their design, and help evaluate the relative performance of different design alternatives.

DES models can assist in evaluating the performance of alternative scenarios for complex systems and processes, such as those involved in PD. For example, a simulation model of a software development process to enable the estimation of delivery time and quality metrics has recently been proposed to help project managers control their project and identify alternative planning approaches (Kouskouras, Georgiou, 2007). A system dynamics modeling approach offers a complementary perspective for complex system interactions such as those occurring in PD, enabling the study of the rate of introduction of new features influencing quality, subsequent rework and resources required to fix field issues, taking away from resources available for PD (Rahmandad, Weiss, 2009; Repenning, Goncalves, Black, 2001).

Although waste reduction initiatives in a lean PD context are stimulated by benchmarking performance comparison presented earlier, and DES provides assistance in ascertaining the influence of various PD process parameters such that overall PD system performance is improved, it remains that, in the spirit of true lean PD, decision making about which task to assign engineering resources to, will influence the value that can be realized from the investment in engineering resources. Thus, the evaluation of value associated with various engineering tasks is of great importance, given the common desire of businesses to continually increase the return to their shareholders.

4.3 Engineering Job Sizing approach

4.3.1 Economic Design Quantity (EDQ) Analytical Model

The model presented in this chapter provides a basis on which to establish the optimal engineering job size from a cost minimization standpoint in the important field of PD. Models, by definition, are an abstract representation of reality, and carry with them a number of assumptions that need to be carefully considered in any application. The usefulness of this analytical model version of the DES approach is that the former, once created, can more easily be used and interpreted by most trained personnel. It is also quite inexpensive to operate, in comparison to DES, given it does not require expensive computing systems, proprietary software, and extensive data collection, provides more rapid results, and can easily be applied into a number of different PD situations. However there are a number of assumptions made in the analytical model.

Assumptions for the EDQ model includes a constant and continuous demand (D) for engineering design jobs over an infinite time horizon, an initial setup (A) to create the design job, which refers to a gradual build up of intellectual work in progress inventory (IWIP) as design effort is expended until the design job is incorporated into a bill of materials (BOM) through an engineering change (EC), and job value (V) is realized. The PD system is characterized by a number of phases operating concurrently to varying degrees. The model assumes a linear relationship between the inverse of the number of phases (N) time the ratio of hours spent in concurrency (c) to evaluate the impact of these factors on the lead time, and thus IWIP, given the Little's law relation. Equations 23 and 24, as well as Figure 9, provide more insights into this relationship. Concurrency is an attribute of the PD system in which development step efforts can overlap, as shown in

Figure 9. An illustration of the concurrency phenomenon can also be seen in the Gantt chart found in Appendix 1

Another important factor unique to PD is the concept of focus (f), defined as the ratio of studied value stream charged hours over total hours charged by employees involved in the said value stream (as shown in Equation 26 which will be discussed later). In addition, an illustration of focus for two different value streams is provided in the previous chapter (i.e., Figure 8). The model incorporates this factor by looking at the ratio of hours spent on value stream jobs over all hours spent by engineers contributing to value stream tasks, again assuming a linear relationship between the level focus and lead time, and thus IWIP, given Little's law relation. The model also assumes that the concurrency level influences the amount of waste rework (w) in a linear fashion (refer to Figure 12 for an illustration of this concept). The implication of this is that the more concurrency there is, the more rework is generated. For example, the design and analysis of engine externals, such as tubes, are commonly redone, with high concurrency between tube design and the analytical process, and information gathering about the nacelle to engine interface and customer equipment location. The above is clearly muda or waste, while an iterative process of known number of iterations, such as airfoil design, resulting in better solutions, would not be considered waste. The model assumes that lead time and resulting IWIP is linear with job size irrespective of the PD system utilization level. This may not be the case at higher utilization levels, and use of Markov chain based lead time correction factor examined, as proposed by Smith (2007). Finally, the model implicitly assumes that the various deliverables on a given post-certification task can be combined in such a way as to correspond to the optimal job size extracted from the EDQ model.

To start with, some variables need to be defined. Given that Ec_{il} is the cumulative engineering effort expended on value stream l jobs j within phase i until the start of the next adjacent phase $i+1$, the concurrency level c_l , can be defined as follows:

$$c_l = \frac{\sum_{i=1}^{n-1} (E_{il} - Ec_{il})}{\sum_{i=1}^{n-1} E_{il}} \quad (23)$$

where E_{il} corresponds to the engineering effort expended on all jobs j in phase i for value stream l , for a PD system consisting of n phases. Figure 9 below provides an example of how phase concurrency is determined for a PD system consisting of 3 phases. The rationale for using effort rather than span time to measure concurrency is vividly illustrated for a selected PD value stream studied in the Gantt chart provided in Appendix 1. As can be seen, there seems to be very high concurrency over time across all jobs and phases constituting the studied project value stream. However this is due to the way job start and end dates are established, i.e., based on time card charges, with job birth (creation) and death (incorporation) charges captured in the job, whereas core PD activities have not started yet, or have ended a long time ago. Thus, for this research, considering the available data, and in order to avoid introducing a systematic bias in the analysis, it is preferable to use an effort based concurrency definition, rather than a span time based one.

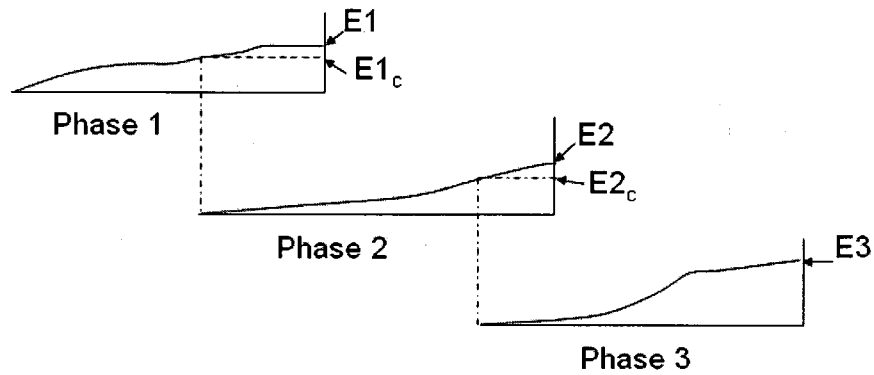

Figure 9. PD Task Concurrency

The lead time impact concurrency factor f_c for a PD system consisting of n phases is defined as follows:

$$f_c = \left(\frac{1}{n} - 1\right)c_l + 1 \quad (24)$$

For a PD system consisting of 1 phase, f_c equals 1, i.e., there are no lead time benefits possible from concurrency as the PD value stream defined is made of only one phase. For cases where the number of phases is higher than unity, the lead time impact concurrency f_c varies from unity (i.e., no impact) to the inverse of the number of phases (i.e., greatest lead time impact), in accordance with the concurrency level c observed. Figure 10 provides an example of the concurrency level c relationship to the lead time impact concurrency factor f_c :

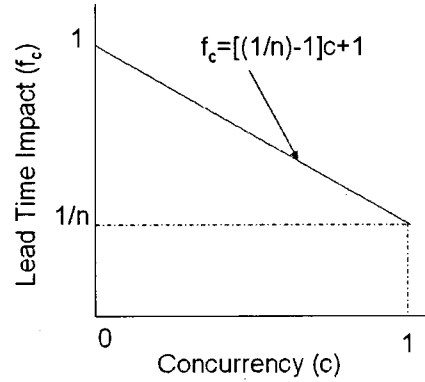

Figure 10. Concurrency Factor

The total effort for value stream l jobs in phase i is defined as:

$$E_{il} = \sum_k \sum_j CHRS_{ijkl} \quad (25)$$

and considers time card charges coming from all k nodes (or employees) charged against value stream l job j during phase i .

Value stream l focus f_l is defined as the ratio of the sum of all the engineering charges for the value stream tasks being analyzed, over the sum of all engineering charges for all value stream jobs and activities, as follows:

$$f_l = \frac{\sum_{i=1}^n E_{il}}{\sum_i \sum_j \sum_k \sum_l CHRS_{ijkl}} \quad (26)$$

The impact of the lead time focus factor f_f on engineering task lead time is defined as follows:

$$f_f = \frac{1}{f} - 1 \quad (27)$$

Based on the definition of focus in Equation 26, in the extreme case where the focus factor f_i for value stream 1 is null, indicating an absence of charges and a null numerator in Equation 26, then the lead time impact according to the lead time impact focus factor f_f is infinite, meaning that completing the planned effort takes infinity, as there is no focus on this value stream jobs. At the other extreme it can also be seen that with a value stream focus f_i of unity, the lead time impact focus factor f_f adjustment is null, meaning that when PD resources are fully dedicated there is no additional lead time arising from multitasking (notwithstanding the utilization induced queuing time not considered here). Figure 11 below provides an example of the focus level f relationship to concurrency factor f_f :

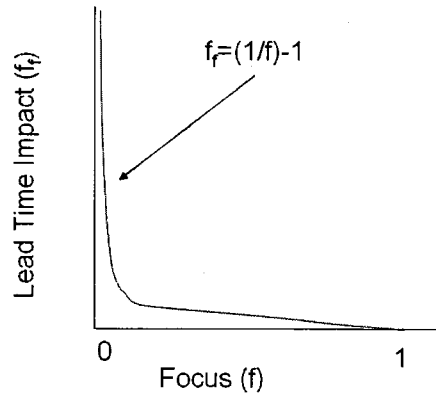

Figure 11. Focus Factor

As indicated previously, the relationship of concurrency c to rework waste (w) impact factor f_w is assumed linear for simplicity, as follows:

$$f_w = cw \quad (28)$$

Figure 12 provides a representation of the assumed linear relationship of the rework waste factor f_w to concurrency. While the concurrency to rework waste factor

relationship tends to be non-linear, minimal for low levels of concurrency and rapidly increasing, there is no impact on the economic design quantity results of assuming a linear relationship; given that rework waste w is not a function of job size Q as can be observed in Equation 29 and Equation 30. However take note that changes in the concurrency to rework waste factor would change the appearance of the TRC curve.

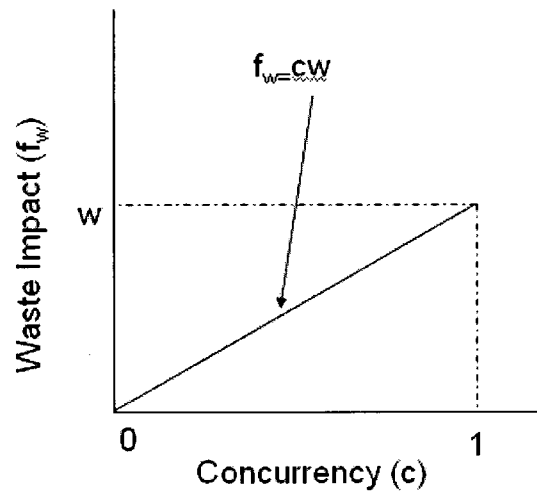

Figure 12.Rework Waste Factor

Additional factors to define for the EDQ model include the value stream demand (D) in hours per year, which represent the anticipated demand for engineering services from a specific value stream in a given year. The administrative setup cost (A) in dollars represents the effort associated with creating an engineering task in the PD system, and includes among others items such as reviewing the need to create the engineering task, setting up the task in various information systems. The carrying cost (r) in dollars per dollar per year is used to determine the opportunity cost associated with the intellectual inventory, and includes among others items associated with the cost of borrowing money, and obsolescence associated with intellectual inventory, the value of a unit demand (v) in

dollars per hour represents the fully burdened hourly rate associated with the engineering value stream for which job size are analyzed , and finally the job size Q in hours represents the size, in terms of effort, of engineering tasks. Factor β represents the decreasing relationship of waste percentage to job size observed from the discrete event simulation results in Figure 18, and represents the negative slope that can be estimated from experimental results. Before defining the mathematical relationship between all these factors, let us examine the IWIP profile chart shown in Figure 13, deduced by observing the influence of focus and concurrency on the accumulation of IWIP in the PD system.

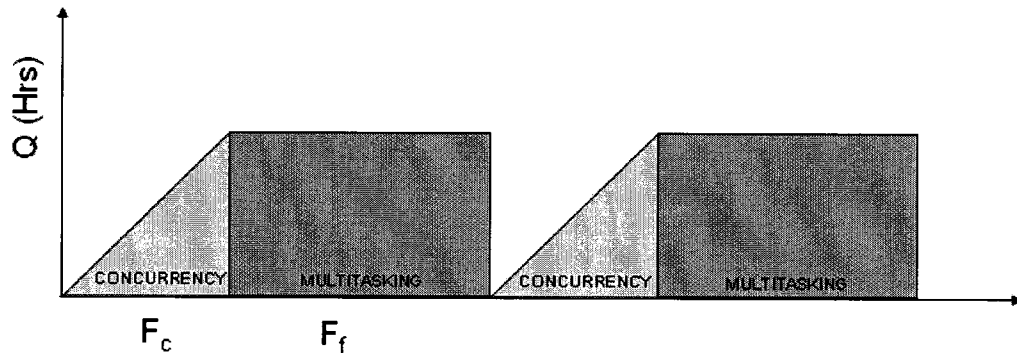

Figure 13. IWIP Profile

As can be observed from Figure 13, the IWIP in the EDQ model progressively builds up, and the extent of its existence in time is influenced by the concurrency level factor. To illustrate this, consider the extreme situation where there is 100% concurrency between phases; assuming phases are of equal duration. The existence of IWIP in the system is reduced by the factor $1/n$, as explained in Equation 24 and Figure 10. In addition, the quantity of IWIP is also affected by the rework waste and concurrency

relationship established in Equation 28. To the same extent, the same IWIP existence in time can also be extended due to a lack of focus, as represented by the focus factor. With the main assumptions and variables explained, let us now look at the total relevant cost (TRC) of the EDQ model.

$$TRC(Q) = \frac{AD}{Q} + \frac{Qvr\left[\left(\frac{1}{n}-1\right)c+1\right]}{2} + Qvr\left[\left(\frac{1}{n}-1\right)c+1\right]\left(\frac{1}{f}-1\right) + vDcw + vD[1 + \beta Q] \quad (29)$$

The first term considers setup cost, and is captured in the multi-criteria lean performance model of the previous chapter as setup; the second term represents the concurrency IWIP illustrated in green in Figure 13; the third term represents multitasking IWIP illustrated in red in Figure 13; the second to last term represents cost of waste rework due to concurrency and finally the last term represents the cost associated with the decreasing waste percentage (i.e. setup, restarts, and wasted setup) observed with increasing job size, as can be observed from discrete event simulation results in Figure 18, taking note that for the extreme case of $Q=0$, the setup waste percentage equals 100%.

Differentiating with respect to Q , the optimal PD job size Q^* incorporating the influence of the number of phases, concurrency and focus level is:

$$Q^* = \sqrt{\frac{2AD}{\left\{vr\left[\left(\frac{1}{n}-1\right)c+1\right]\left(\frac{2}{f}-1\right)\right\} + 2vD\beta}} \quad (30)$$

Note that due to the definition of rework waste w as a function of concurrency c , it is not included in the optimal PD job size, but still considered in the TRC. What is meant by this is that waste related to concurrency is not a function of job size, but rather of how the PD system is organized, and thus not varying as a function of job size. When

differentiating with respect to Q , this term then gets eliminated from TRC. However, the decreasing relationship of waste percentage to job size observed from the discrete event simulation results described below in section 4.4 allows for the inclusion of this factor in the optimal PD job size equation.

4.3.2 Simulation model

A DES model is used to experimentally examine the influence of focus and concurrency on lean PD performance metrics, and especially to investigate the influence of the number of engineering setup waste and lead time metrics. Figure 14 provides an overview of the DES model developed for this research. The model is built using Matlab® discrete event simulation toolbox Simevents®. Entities in the model consist of exponentially distributed, randomly generated charged hours by task, and replicate the observed charged time pattern. An explanation of the how the model works is provided below.

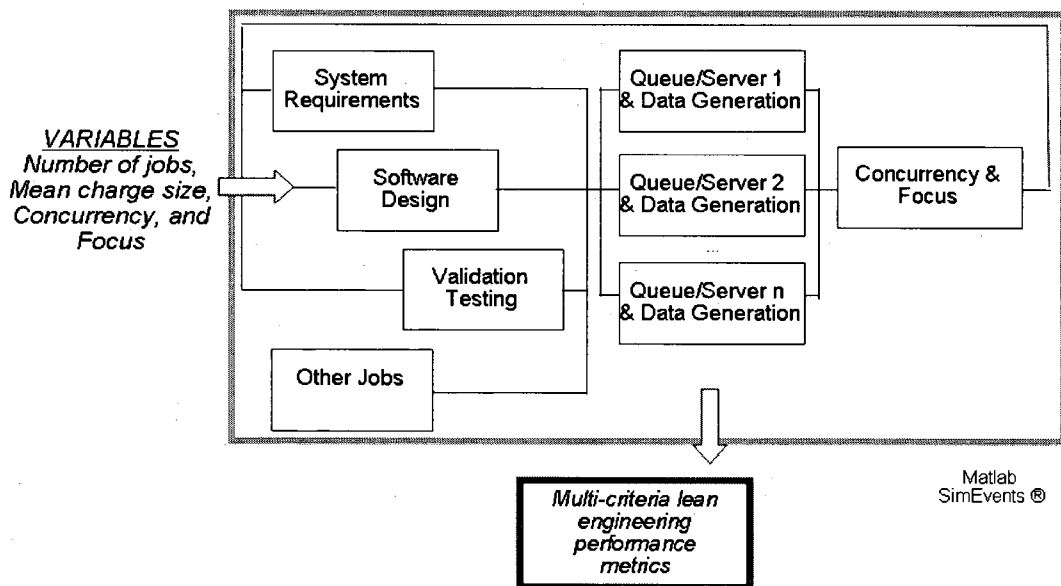

Figure 14. Simulation Model

The DES model covers the key phases of system requirements, software development and validation for the selected PD value stream in the case company, as shown in Appendix 1. The start of each phase is modulated by the percent completion of the previous phase, thus allowing a given level of concurrency. Given that varying levels of multitasking were observed in the gathered data, capabilities are provided to study the influence of this factor by changing the hours controlling the generation of entities in the “other jobs” sub-system. A previously published lean engineering multi-criteria performance model is used to provide a measurement of PD productivity (Beauregard, Thomson, Bhuiyan, 2008), for simulation results as well as for the value stream benchmark study.

An analysis of the time charging patterns was performed to determine the most suitable statistical distribution for the entity generation used in the DES model. Refer to Appendix 2 for more details on the data and the code used for the descriptive statistics analysis. Figure 15 shows the cumulative distribution function of the pre-certification value stream for the analyzed time card charges, which are grouped in consecutive five minutes time intervals. As can be seen, an exponential model adequately explains the observed time card charge pattern with similar results found for the post-certification value stream, with a coefficient of determination R^2 above 0.95.

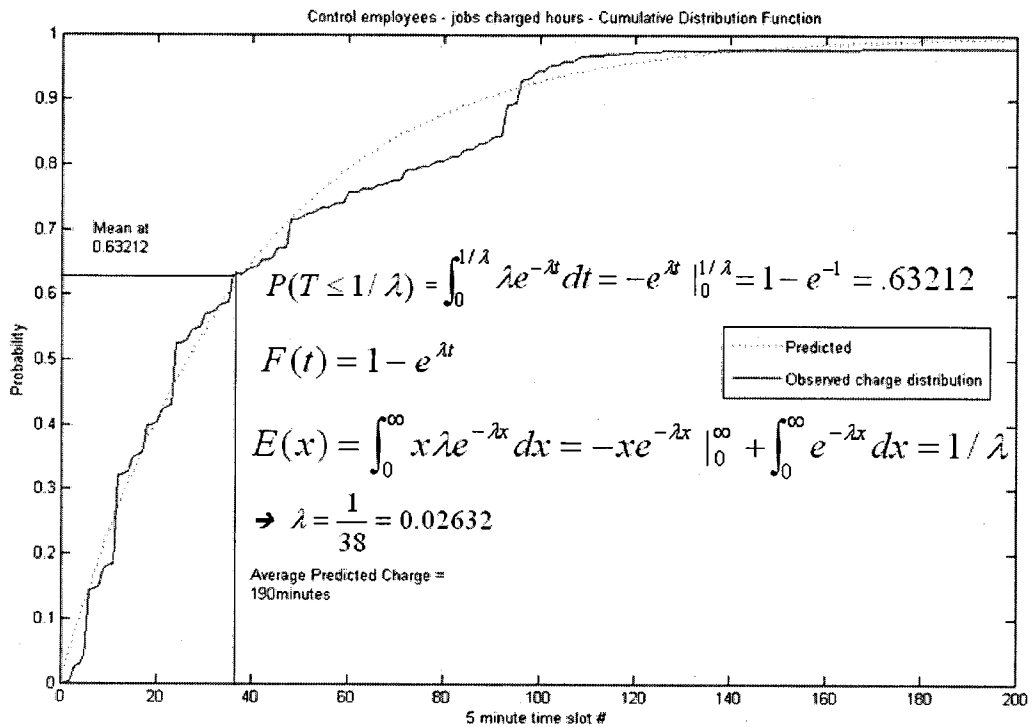

Figure 15. Charge Distribution

The code for the discrete event simulation model as well as for the descriptive charged hour statistics, can be found in Appendix 4. Results are provided in the following section.

4.4 Results

In this section the economic design quantity results are provided as well as those of the discrete event simulation.

4.4.1 EDQ Analytical Results

The economic design hours quantity for various combinations of concurrency level c and focus level f for the industrial case study PD system examined in this thesis are shown in Figure 16. These results have been derived using Equation 30, keeping

quantities for the different factors corresponding to the selected value stream observations constant, but varying both the concurrency and focus levels, and the PD job size, so as to generate the surface provided and ascertain the relative influence of focus and concurrency on the size of the economic design quantity (EDQ). The surface is the optimal design quantity of hours Q^* . As can be noted, the EDQ increases non-linearly with an increase in focus, and also non-linearly with an increase in concurrency. Other factors have been set for this example as noted in Figure 16 with $D=50000$, $A=700$, $v=100$, $r=.1075$, $n=3$, $w=.05$, and $\beta = 0$. Care should be exercised utilizing the percentage waste slope factor β so as not to extrapolate past a value of Q equal to the absolute value of the inverse of the slope, given the lack of physical significance for the negative waste percentage that would otherwise be obtained past this point. Refer to Appendix 3 for the EDQ code details.

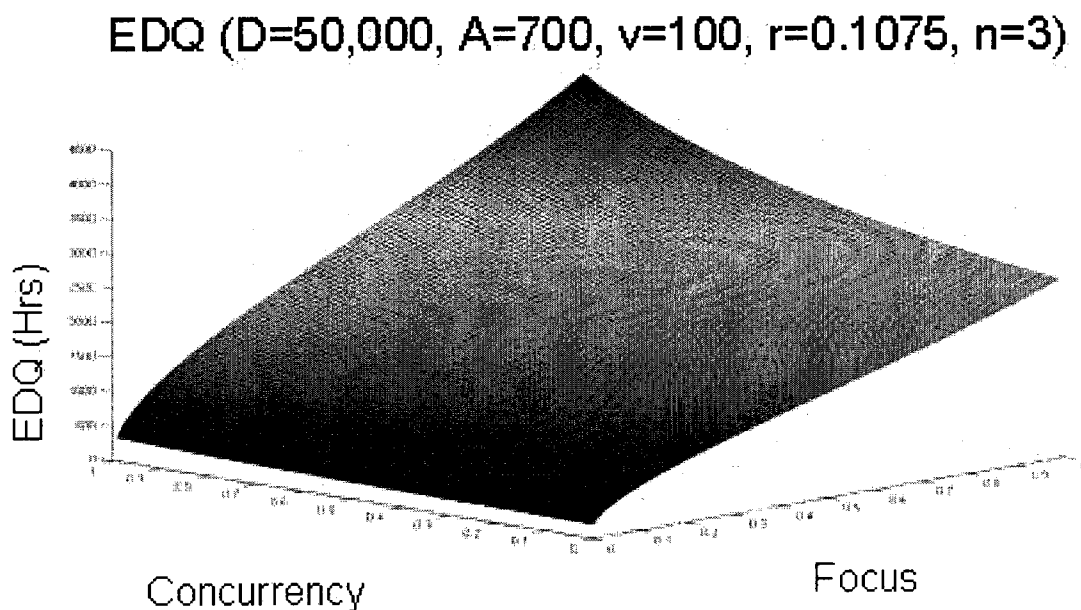

Figure 16. Q^* for c and f

Figure 17 below shows the behavior of TRC versus focus and concurrency levels in the first sub-plots. It then highlights in the next three sub-plots the TRC and Q^* that can be obtained within 25% of optimal budget (obtained at $c=0, f=1$), within 25% of optimal schedule (at $c=1$ and $f=1$), and combining these 2 factors, taking note that the best schedule is valued at $1/n$. The last two sub-plots show the EDQ with the optimal region within 25% of the lowest overall TRC and schedule as shown in the last sub-plot, with Q^* values varying in the range comprised between 2000 and 2500 hours. Figure 17 also uses a value of $\beta = 0$, for similar reasons as noted above.

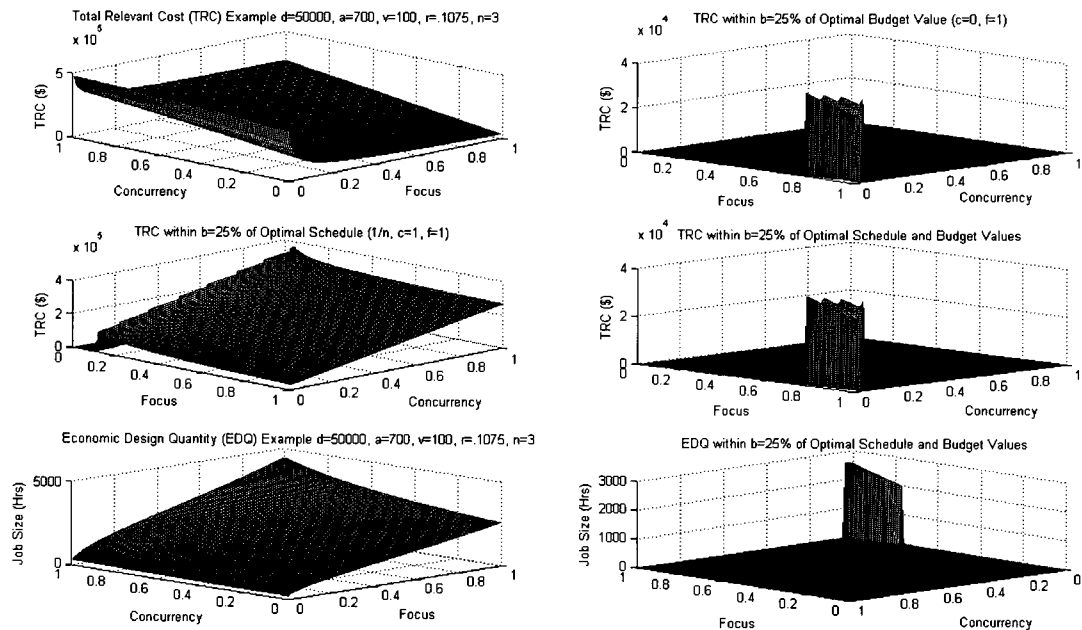

Figure 17. Optimal Regions

4.4.2 DES Experimental Results

To further examine the influence of focus and concurrency on lean PD performance metrics, and investigate the presence of optimal engineering task size, a DES model, as shown in the previous section was built. For each PD job, the data from

the case company was used, for each of the various phases of system requirements definition, software coding, and validation, including lead time and effort. Table 2 below provides an overview of the simulation configurations and results obtained versus those measurements from the actual value stream in the first results row.

Table 2. DES results for f=.15, c=.26

Product PD Process Simulation Results DOE input f=.26, c=.20	Average Calendar days	Average Working Days	Average Charged hours	Average Touch days (TD)	Average Non touch days (NTD)	Average TD hours charged	Average NTD hours charged	Average Restarts	Average Number of nodes	Average Touch time ratio (TTR)	Average Waste %
Observed data	201.8	144.1	888.9	58.4	85.7	866.3	22.2	1.3	5.4	40.5%	3.3%
R1- Job size (L)	1431.3	1022.4	444.4	51.9	970.5	385.4	59.0	6.4	15.6	8.1%	53.1%
R2- Job size (L)	1431.3	1022.4	444.4	51.9	970.5	385.4	59.0	6.4	15.6	8.1%	53.1%
R3- Job size (L)	1456.2	1040.1	444.5	52.0	988.1	384.3	60.2	6.7	15.8	8.3%	54.2%
R1- Job size (Nominal)	1163.9	831.4	889.1	84.3	747.1	771.5	117.6	6.4	19.7	12.7%	40.4%
R2- Job size (Nominal)	1210.7	864.8	888.6	84.8	780.0	768.9	119.7	6.2	19.7	12.6%	41.3%
R3- Job size (Nominal)	1206.5	861.8	888.6	85.0	776.9	771.4	117.2	6.4	19.6	14.0%	37.4%
R1- Job size (High)	1736.2	1240.2	1807.8	148.5	1091.6	1569.8	238.0	6.1	27.4	18.2%	24.0%
R2- Job size (High)	1820.5	1300.4	1807.5	146.6	1153.7	1561.5	246.1	5.8	27.1	17.6%	24.0%
R3- Job size (High)	1818.4	1298.9	1807.6	148.5	1150.4	1569.4	238.2	6.3	27.0	17.8%	23.2%

These results represent a subset of a full factorial design of experiments (DOE) that was performed with r=3 replications and for k=3 factors (focus, phase concurrency, and mean of the charged hour distribution), covering each combination of phase concurrency and employee focus at two levels (high, low), and job size at three levels (half, nominal, double). Two lean PD performance response metrics were calculated. Response variables were lead time (LT) and setup waste percentage. Interaction plots showed that the mean of the charged hour distribution $1/\lambda$ (defined in Figure 15) does not appear to have a significant impact on LT, while focus has the highest influence on LT, and concurrency has a moderate one. Table 3 below shows that focus, concurrency and two way interactions were significant factors affecting LT, given the p-values less than the 5 percent significance value. The null hypothesis that there is no factor effect can thus be rejected, indicating that the corresponding coefficients are different from 0.

Analysis of variance was conducted and the model was explained in term of the LT response, with the constant and factor coefficients as noted in the table below for focus, concurrency, as well as two way interaction.

Table 3. Factorial fit for LT vs c and f

Estimated Effects and Coefficients for LT (coded units)

Term	Effect	Coef	SE Coef	T	P
Constant		198.10	2.535	78.14	0.000
Task Focus	-121.32	-60.66	2.535	-23.93	0.000
Phase Concurrency	-37.55	-18.77	2.535	-7.41	0.000
Task Focus*Phase Concurrency	-17.03	-8.52	2.535	-3.36	0.003

S = 12.4196 PRESS = 4442.28
R-Sq = 96.96% R-Sq(pred) = 95.63% R-Sq(adj) = 96.51%

Analysis of Variance for LT (coded units)

Source	DF	Seq SS	Adj SS	Adj MS	F	P
Main Effects	2	96766	96766.4	48383.2	313.68	0.000
2-Way Interactions	1	1741	1740.8	1740.8	11.29	0.003
Residual Error	20	3085	3084.9	154.2		
Pure Error	20	3085	3084.9	154.2		
Total	23	101592				

Figure 18 illustrates the convex relationship obtained between task size and lead time, and the decreasing relationship of setup waste to job size for low focus and low phase concurrency. Three replications were run for each of job size simulated (low, nominal, high) to observe the convex relationship. In the discrete event simulation model the parameter determining the minimum LT point for a given focus and concurrency scenario is job size. Sensitivity can be ascertained by looking at Table 2. Focus influences the number of charging entities generated by the 'other job' subsystem in Figure 14, and the 'low' value was set at fifty percent of the difference between total hour charges and total hours charged on studied tasks for $f=0.15$, while for 'high' value of

focus, this was set to one hour only, corresponding to value stream dedicated resources with $f=1$.

Concurrency determines the earliest that a subsequent phase can start generating entities, by examining the previous phase cumulative hours completed. The rationale for this is based on the fact that precedence relationships in PD are based on delivery of a given set of outputs with the amount of output generated in a previous phase related to rework waste induced in a later phase. The choice of particular values for high concurrency is motivated by value stream observations as illustrated in Appendix 1. Low concurrency was set as eighty percent of previous phase hours required to be completed prior to start of the following phase, that is, only twenty percent of the remaining phase hours are done in parallel with the subsequent phase (i.e., $c=0.2$), whereas high concurrency was set at twenty percent only, that is, eighty percent of hours of the previous phase are done in parallel with the subsequent phase (i.e., $c=0.8$).

The results obtained provide evidence as to the existence of an optimal task size for the PD system analyzed. A task size to average lead time relationship has thus been established also using the pre-certification data and experimental simulation results. More entities on various tasks get generated at the same time for lower task size in the PD system. The additional number of tasks for which time card charges are now possible results in a longer time required to finish smaller task sizes on average, while larger tasks take longer to complete by virtue of their higher work content. An error of between five to seven percent for nominal, half or double job size has been obtained for average lead time. This level of error in the results was determined by computing the average LT response for each job size value for the three replications, and ascertaining the minimum

and maximum difference between respective averages and constituting data points. A decreasing relationship of average percent setup waste to job size has also been observed, with an error of one to three percent obtained. This error was determined in a similar fashion as that mentioned above. Given care has been taken in the design of the model to ensure minimum variance in results by using the same pre-established charge distribution based on observed data, for each phase in all replications of the discrete event simulation for a given job size, this error represents randomness in results. Please note that the setup waste measured here is consistent with the definition given in chapter 3, and is meant to represent setup as well as well as wasted setup. Note that the setup cost portion is also captured by the first term of Equation 29, the analytical EDQ model, and expected to be decreasing with higher job size, given the number of setups, and hence setup waste, is inversely proportional to the job size. As expected, results from the simulation indicate that lower setup occurs with higher job size, thus the decreasing relationship observed, which support the previous analytical model. The relationship of waste percentage to job size can thus notionally be expressed as $1 + \beta Q$, where β represents the slope of the relationship (a negative value), and the intercept of 1 reflects the notional maximum waste percentage of 100% as Q attains the extreme value of 0. Extrapolating waste percentages outside the simulation results range provided below is not suggested, as negative waste percentage may be generated from greater than inverse of slope job size values.

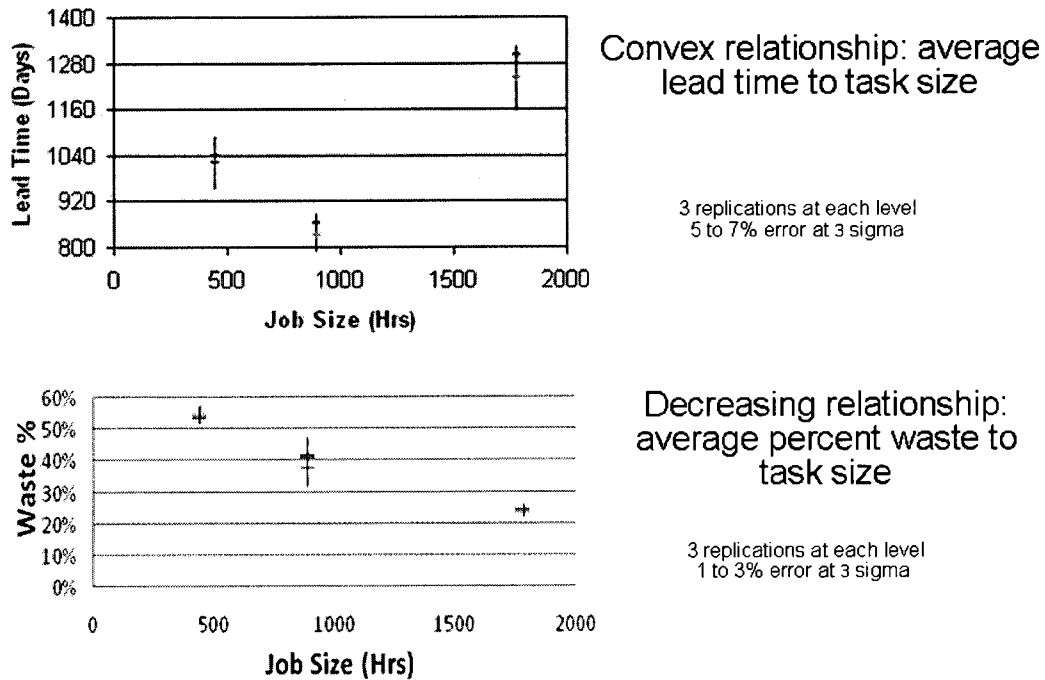

Figure 18. Task size to LT and Setup Waste

4.5 Discussion

In the following section a short discussion on the models and results is proposed, for the economic design quantity analytical model as well as for the discrete event simulation experimental model.

4.5.1 EDQ

Figure 19 below provides in the top part the breakdown for the various components of TRC at concurrency level of $c=0.7$ and focus level of $f=0.1$, for various settings of Q for the value stream of the industrial case. Each components of TRC in Equation 29 are represented in the plots. The rework waste cost is not varying in relation to PD task size, but is rather strongly influenced by the concurrency level. Considering the previously discussed limitation of simulation results with respect to the applicable

range of Q for the waste percentage factor β , its value is set at 0 in Figure 19 below, to avoid generating negative waste percentage values given the large range of Q investigated. Note that the ordering curve represents setup waste, and as expected is showing a decreasing relationship with job size, in accordance with Equation 29, and as well with discrete event simulation results illustrated in the lower portion of Figure 18 for setup waste. The carrying cost emanating from the focus element is linearly related to the task size, and its significance can be observed by comparing the first subplot with focus at 0.1 to the second one with focus at 0.9. The TRC curvature observed in the first subplot in Figure 19 at low value of focus can be explained by this factor. It can also be observed that Q^* is in the 1000 hours region, which is in line with the observed case company value stream average job size as previously reported in Chapter 3. Note that this is a coincidence that the observed average job size corresponds to the optimal. However much variability exists in the actual job size with coefficients of variation (standard deviation/average) above two hundred percent observed in actual job size distribution. Also as explained next the total relevant cost of the PD system could be much lower by operating it in alternative conditions of focus and concurrency.

In the bottom part of Figure 19, the TRC is provided again for different values of Q , but this time for near optimal conditions of engineering focus and PD system concurrency levels of 0.9 and 0.1. Two observations can be made for this figure. First, the sensitivity of TRC to changes in Q is much less when operating in near optimal condition, than it is when operating in the current company conditions. Also, the magnitude of the TRC at near optimal conditions is more than four times less than that of

the TRC at current case company operating conditions, thus pointing out to available improvement opportunities to further improve the performance of the whole PD system.

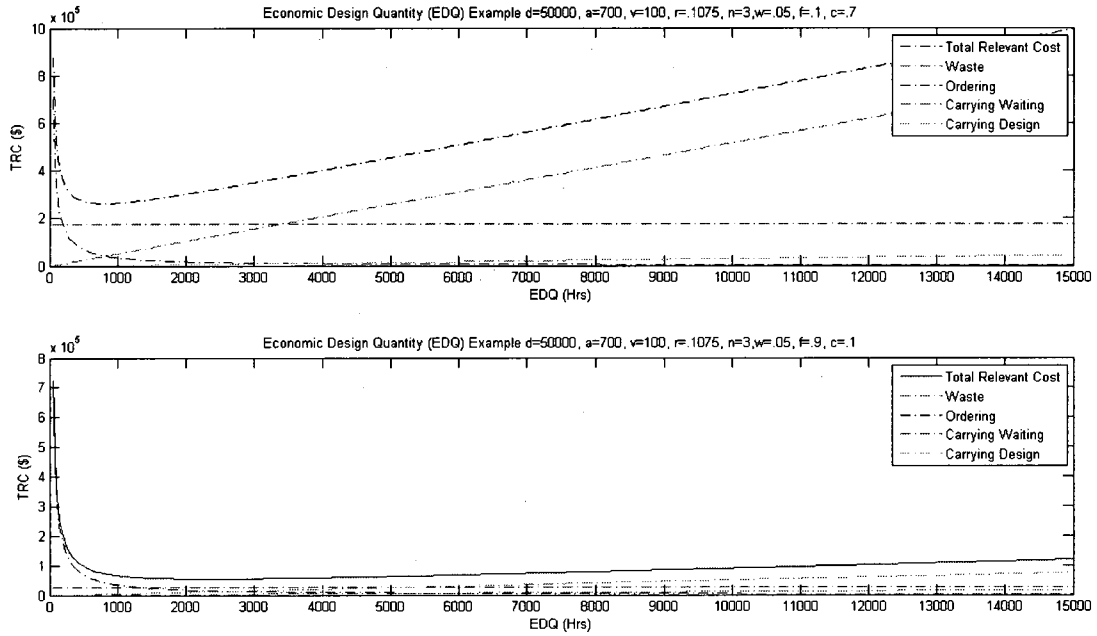

Figure 19. Current to Optimal TRC

Although the analytical model provides a simple and elegant solution to the sizing of PD tasks, it should be remembered from the literature review that the sizing of PD tasks in reality is influenced by a number of other factors in addition to those considered in the cost minimization approach, that may influence the ability to implement the optimal job size. However establishing appropriate concurrency and focus task management policies to operate the PD system in the lowest cost region decreases significantly the sensitivity of the total relevant cost to variations in job size, pointing to the importance of continuous improvement in terms of waste reduction (setup and rework), that might otherwise prevent operation into the most favorable regime of concurrency and focus.

As can be observed from these results, the PD system performance is strongly influenced by the levels of focus and concurrency. Establishing appropriate policies and procedures to gain control over these key parameters of the PD system is critical to achieve the best TRC possible. Without such control on what gets released to the engineering PD system, there is great difficulty controlling what engineers work on, and likely their effort will diffuse to a number jobs, leading to a lower than desirable focus.

4.5.2 DES

The DES model demonstrated that a varying number of jobs in the PD system with varying task size would affect lead time. The observed non-linear effect of job size on lead time would suggest that the linear IWIP carrying cost relationship established in the EDQ model needs to be revisited for smaller job size. Further work should be accomplished using queuing theory to ascertain the form and value of the required adjustment factor to the EDQ model to account for this factor. The DES is helpful to experimentally validate the influence of the PD system design configuration in terms of anticipated lead time, as some organizations might be interested to manage job duration rather than size in quantity of hours of required effort.

Comparison with actual results observed in the sampled tasks in Table 2 also points to limitations in the current DES model. Although the nature of PD is such that a task is handled by specific engineers with adequate knowledge, limitations with the number of possible blocks in the version of the simulation software resulted in inadequate modeling of the observed, real life design behavior. Improvement in the DES model to address the noted deficiencies should be conducted in the future, given that these limitations somewhat biased the experimental results. Further work to study the

influence of alternative prioritization schemes on realized value, such as earliest due date, or shortest weighted remaining processing time, and on time delivery performance metrics, is also required.

4.6 Conclusions

A novel economic design quantity (EDQ) model has been developed to study the influence of concurrency, focus and rework among other factors on the total relevant cost (TRC) of the PD system. The model enables the determination of the optimal PD task size, and enables a comparison of TRC at current PD operating conditions to those at optimal conditions. Results indicate that the focus factor has a more significant influence on the cost performance of the PD system than the concurrency factor.

A DES model was then developed to study the influence of task size and other factors on the performance of the PD system. The model also showed that LT performance is also significantly influenced by the level of focus and to a lesser degree by concurrency. The non-linear influence of the number of jobs on lead time is suggested by the DES model, and further work using queuing theory is suggested to determine and incorporate relevant factors in the EDQ model. Future work should also involve the development of an enhanced simulation model to reduce the difference between experimental and actual results.

Designing and operating a more cost effective engineering organization is desirable and possible. By integrating notions of production and inventory management with lean, and developing an EDQ model, this chapter offers the foundation for the establishment of an engineering job policy that can help companies to enhance their competitiveness.

5. Engineering PD Value Optimization

In this chapter an engineering task value optimization approach is developed, combining multi-attribute value theory (MAVT) with linear programming resource allocation models for medium and short term problems, to further improve the value delivered by a PD engineering system. The motivation for investigating the value optimization approach for a PD system is provided in the next section. Then, background for PD resource allocation value optimization approaches is offered. Next, the proposed engineering PD value optimization approach combining MAVT and integer linear programming models are described. The results are then provided, and discussed in the next section. A conclusion is finally provided in the last section of this chapter.

5.1 Motivation

From a business standpoint, the strategic and financial value of pre-certification PD activities is generally well-understood. Executive attention, decision making and appropriate processes are available to ensure continued alignment of available resources and prioritization with corporate objectives. However, in the post-certification world, the high number of disparate tasks, large customer base and high number of decision makers makes it more difficult to agree on consistent value dimensions. A multi-attribute engineering task value model (MAVT) is developed to support a consistent quantification of value, and determine tasks that are of high enough value to compete for allocation of scarce PD resources.

The PD resource allocation system must be designed to support the firm's goals and strategies. The PD resource allocation generally consists of medium-term resource

planning to ascertain the tasks that should be allocated resources in a given timeframe, followed by short term allocation of specific resources to PD tasks (Talbi, 2009). Thus, the medium-term problem of allocation of PD resources to tasks requires considering multiple task level attributes, such as task type, project type, required resources, due date, task value, as well as project level attributes such as available budget, required resources, and finally PD system level dimensions, including available engineering capacity, relative importance of different tasks types and project types, among others. The short-term problem of allocation of resources to PD tasks consists of selecting the best available resources such as to maximize the output in a specific timeframe, considering the available resources' skill level, task complexity, characteristics of the project, such as its classification (civil or military), clearance status for military jobs, and resource requirements.

There are multiple motivations for this part of the research. The absence of an integrated resource allocation approach adapted to the peculiarities of PD, the problem size limitation of current exact integer linear programming optimization solution approaches, the performance issues associated with solving industrial-sized metaheuristic resource allocation problems, the inconsistency amongst decision makers associated with deciding which task to prioritize and work on, the lengthy duration of the planning cycle observed in the case company with uncertain outcomes and benefits, and the lack of an integrated approach in the background material reviewed, all provide incentives for this research.

In this chapter a novel task value optimization approach is developed, based on maximization of value and of output for medium and short term resource allocation problems respectively. While the previous chapters have investigated the measurement of PD performance, as well as the influence of task management policies on PD performance, this chapter deals with the very important aspect of resource allocation to PD tasks, as a key determinant of PD realized value.

5.2 Background

In this section a review of prior task value optimization approaches and applications to the engineering PD domain is conducted in order to provide an appropriate perspective of the research contribution from this chapter. It should be noted that the way resources are allocated to PD tasks influences the value that is realized by the PD system (Ngo-The, Ruhe, 2009). To start with then, a review of notions of value and MAVT in PD is conducted, followed by a review of PD value optimization through resource allocation.

With its capability to simultaneously handle many facets of a problem, multi-criteria decision aiding (MCDA) methods can assist in determining engineering task value. Decision-making is all about preferences. There are two schools of thought in MCDA: ordinal methods (i.e., Electre) and cardinal approaches such as multi-attribute value theory (MAVT). Multi-criteria decision-making problems occur in a number of fields such as portfolio and R&D project selection (Wallenius, Dyer, Fishburn, Steuer, Zionts, Deb, 2008).

There is usually no attempt in multi-criteria optimization problems to identify decision maker utility; instead, an iterative process using implicit information about

decision maker preferences is used to direct the decision maker to the preferred solution. In principle, where the number of alternatives is limited, the implicit information about trade-off preferences and possible relaxation of criteria should enable an interactive method that converges in a small number of iterations to a user preferred optimal, final solution, such as to complete the decision-making process. Given the high number of possible decision alternatives in the industrial-sized problem being tackled in the case company, outranking methods, otherwise well-suited to discrete multi-criteria problems with a limited number of alternatives, are difficult to apply to the case at hand.

Many definitions of value have been proposed over time (Park, 1998; Slack, 1999); for example, the value of a business aircraft can be expressed as the ratio of the product of speed, range and cabin volume over maximum take off field length (Dowden, 2005). However, care should be exercised when designing such models, as ‘addition and multiplication are not applicable on utility scale values’, and there is ‘no empirical addition for psychological variables’ (Barzilai, 2008). Thus, using physical variables is encouraged.

Contrary to MCDM, MAVT is based on the assumption that decision makers attempt to maximize an implicit value function, V . The primary advantage of MAVT, according to Stewart and Losa (2003), is its relative simplicity and transparency, providing support for conclusions and recommendations. The authors show that the axiomatic foundations of MAVT can be reconciled with MCDA, for example using a non-linear value function to overcome the fully compensatory feature of MAVT. They also share that MAVT is also, much like a MCDA constructive approach, with no pre-determined exact model of weights associated with the multiple dimensions of value.

In a practical application of value principles, Keisler (2009) compares the value obtained from the selection of a portfolio of projects ranked by decreasing value per unit cost to other decision making processes, and shows that up to a fifty percent improvement in value can be obtained.

The elaboration of appropriate weights for the various dimensions of a multi-attribute value function is based on percent design rework, document release commitment, and percent schedule delay for the case of a construction project, and is illustrated through the use of the eigenvector prioritization method (Georgy, Chang, Zhang, 2005a). Dimensions of value associated with feature software development include market value, urgency, and customer satisfaction (Ngo-The, Ruhe, 2009).

Thus, eliciting preferences in managerial decision-making during the post-certification phase can be thought of as involving the consideration of a number of dimensions, as well as the definition of supporting criteria, for task prioritization as well as for allocation of limited post-certification budgets and engineering resources. The determination of appropriate dimensions and criteria for value assessment is of utmost importance, and should be linked to a firm's strategic objectives.

A resource constrained project scheduling (RCPS) approach has been proposed, where the objective is 'to construct an execution plan such that the completion time on plural tasks (make span) is minimized, while satisfying the precedence relationships among the tasks, given the resources available' (Yoshimura, Fujimi, Izui, Nishikawi, 2005). Given the lack of precedence relationship data available in the case company project management system (SAP P/S), the RCPS approach is not useful.

Whereas a variety of approaches have been investigated to resolve the mid-term planning problem associated with the optimal allocation of resources to engineering PD tasks in such a way as to maximize value, it is worth noting that in some cases, the use of meta-heuristics would be inappropriate, inasmuch as such problems can be solved via exact optimization methods (Talbi, 2009).

A recent paper by Ngo-The and Ruhe, (2009) investigated the allocation of resources to tasks of implementing features in software development projects, such that the value gained from future releases is maximized. The authors used a linear integer modeling approach to determine the optimal mix of features in a first phase, and then, in a second phase, a meta-heuristic to develop adequate resource plans for the strategy created in the first phase. It is worth noticing that in this case the integer model was limited to two hundred features and six hundreds tasks. Clearly, size constraints may limit the applicability of optimal solving approaches to simpler cases, sometimes outside of the more complex industrial reality.

Chan , Hiroux and Weil (2006) have proposed a model to optimize the scheduling of employees with multiple skills using mixed integer programming. Their proposed approach integrates capacity planning over a given horizon with a scheduling model that details the assignment of employees to activities or skills. They discuss the usefulness of employee proficiency level by skill. A difficulty to expertise factor is discussed in relation to the adjustment of the effort prediction for an engineering job (Bashir, Thomson, 2004). In the next section are presented the value model, and the medium-term and short-term resource allocation optimization models.

5.3 Engineering task value and resource allocation optimization models

This section introduces the task value model as well as engineering resource allocation optimization models developed for the case company. Obviously different dimensions of value are associated with engineering tasks in PD, and application of the models in different organizations would likely results into different value models. However, the general nature of the approach should be of interest to those interested in optimizing value resulting from resource allocation to PD tasks.

5.3.1 Multi-Attribute Value (MAVT) Model

Consistently aligning multiple decision makers for task prioritization and optimal resource allocation is a challenge in PD projects. Effective managerial decisions begin with consideration of the multiple dimensions of value (Mavrotas, Trifillis, 2006). Explicit value criteria are incorporated into a decision model to improve decision making consistency. The MAVT approach involves constructing an aggregate value index by combining various attributes for each post-certification task into a unique value index. Benefits include simplicity, consistency of decision-making across decision makers, and a sense of priority for engineering personnel having to select on which task to work. The value function V for a task t can be expressed as follows:

$$V_t = \sum_{i=1}^n w_i(c_i)v_i(c_i), i = 1, \dots, n, l = 1, \dots, o, t = 1, \dots, m \quad (31)$$

where different value criteria levels v_i are evaluated for each task on scale of 1 to 10 each of which have weights w_i , where $\sum_{i=1}^n w_i = 1$ reflects the relative importance of each criterion.

As previously noted, defining appropriate translation mechanisms between the various criteria constituting the value index, or conducting “even swaps” (Hammond, Keeney, Raiffa, 1998), is a rational way of making trade-offs, and overcoming the previously noted deficiencies in decision theory foundations with mathematical operations on value. Using the business case sensitivity analysis conducted for each PD project, most business related value dimensions can be translated into equivalent net present values (NPV) using the exchange curve as follows:

$$T_{f_i} = \frac{NPV_{l_1, f_i} - NPV_{l_2, f_i}}{f_i l_1 - f_i l_2} \quad (32)$$

where the tradeoff value T_{f_i} for a unit change of factor f_i is the ratio of the delta in NPV amounts observed over different levels l of that factor. With this relationship established, the impact of different factors on value is evaluated in a rational fashion. With the value of a task now defined and the relationship between various attributes established where possible uses of the notion of trade-offs are given, resource allocation models are presented next, starting with medium-term decision-making.

5.3.2 Medium Term Resource Allocation Models

In the medium-term resource allocation problem, the concern is to decide which engineering tasks receive limited available resources. In the mono-period integer optimization models below, there is a unique planning period in which resource

allocation is performed in such a way as to fully satisfy the known resource demands of engineering tasks such that the value realized from these is maximized. Of course, repeated application of this model in time is possible, such that task estimation error or inefficiencies in task execution can be considered in a further planning cycle.

Mono-period Model

A simple linear integer model is developed to assist decision makers in allocating limited resources available to tasks, and to study the influence of alternative task value and project budget constraints.

Assumptions for the resource allocation realized value maximization model are as follows: (i) task (j) ($j \in J$) originating from project (k) ($k \in K$) progresses via effort expended by engineering groups (e) ($e \in E$); (ii) the estimated effort to complete the task (ETC) is available, and task value (V) is pre-established as per above; (iii) limited capacity (C) exists in engineering groups that work on tasks; (iv) limited post-certification budgets (B) are available for each project.

Variables are as follow: (i) B_k represents the pre-determined post-certification budgets in hours associated with each project; (ii) C_e represents specialist engineering groups post-certification capacity in hours; (iii) ETC_{je} denotes demand in hours; (iv) V_j is a pre-determined variable that conveys the value of task j ; (v) the binary decision variable $O_j = 1$ if a task is completed, otherwise $O_j = 0$; (vi) $P_{jk} = 1$ if task j is related to project k , otherwise $P_{jk} = 0$; (v) X_{je} represents the hours allocated by engineering group e on task j . The decision making model to maximize the realized value on completed tasks is as follow:

$$\text{Max} \sum_j O_j V_j \quad (33)$$

To ensure that demand is met for each task for each engineering group, the following constraint is required, ($\forall j \in J$):

$$\sum_e X_{je} = \sum_e ETC_{je} O_j \quad (34)$$

Engineering group capacity is not to be exceeded ($\forall e \in E$):

$$\sum_j X_{je} \leq C_e \quad (35)$$

The project budget is not to be exceeded ($\forall ek \in K$):

$$\sum_j \sum_e X_{je} P_{jk} \leq B_k \quad (36)$$

Next the mono-period model is extended to incorporate additional constraints from discussions and observations in the case company.

Extended mono-period model

A desire in this research is to provide a formulation to the medium-term optimization problem that can be solved by exact methods, such as a branch and bound or the simplex approach, associated with the use of the MAVT approach. In the mono-period extended formulation below, the use of integer decision variables and linear programming achieves that purpose.

The objective of managerial decision-making is to decide which of the multiple post-certification tasks to pursue, given limited resources and budgets, to maximize the realized value over the entire planning horizon. The notion of realized value is introduced; given customer value is achieved in PD upon completion of the engineering tasks. Assumptions are as follows: (i) a task ($i \in T$) originating from a project ($p \in P$)

from an activity type ($h \in H$) progresses via effort expended by various engineering groups ($k \in K$); (ii) the effort to complete the task (D) over the time horizon is available, and task value (V) is pre-established from a set of value criteria ($j \in J$); (iii) limited capacity (C) exists in engineering groups that work on tasks; (iv) limited post-certification budgets (B) are available for each project.

Variables are as follows: (i) D_{ik} represents the quantity in hours of resource of type k required to complete the task i, or in earned value terms the estimate to complete; (ii) V_i is a pre-determined variable that conveys the value of task i; (iii) $\delta_{ip} = 1$ if task i is related to project p, otherwise $\delta_{ip} = 0$; (iv) the binary decision variable $O_j = 1$ if a job is completed, otherwise $O_j = 0$; (v) $\delta_{ih} = 1$ if task i is for an activity of type h, otherwise $\delta_{ih} = 0$; (vi) C_k represents a specialist engineering group's capacity in hours; (vii) B_p represents pre-determined budgets in hours associated with each project; (viii) α_h represents the minimum rate of completion for activity type h; (ix) β_p represents the maximum rate of project p budget allocated; (x) γ_p represents the minimum rate of project p budget allocated.

The mono-period resource allocation decision-making integer linear model formulation is as represented below:

The objective function is to maximize realized value, as follows:

$$\text{Max} \left(\sum_i O_i V_i \right) \quad (37)$$

subject to the following constraints.

Engineering group capacity is not to be exceeded, $\forall k \in K$:

$$\sum_i O_i D_{ik} \leq C_k \quad (38)$$

The total budget is not to be exceeded:

$$\sum_i \sum_k O_i D_{ik} \leq \sum_p B_p \quad (39)$$

The project budget limitations, $\forall p \in P$:

$$\gamma_p B_p \leq \sum_i \sum_k O_i \delta_{ip} D_{ik} \leq \beta_p B_p \quad (40)$$

The minimum rate of completion of given activity types, $\forall h \in H$:

$$\sum_i \sum_k O_i \delta_{ih} D_{ik} \geq \alpha_h \left(\sum_i \sum_k \delta_{ih} D_{ik} \right) \quad (41)$$

Boolean decision variables:

$$O_i \in \{0,1\} \quad (42)$$

This formulation is adequate for small problems; however, given the exponential growth of the integer solution space (Hillier, Lieberman, 2005), a further formulation with decision variables in the real positive domain is developed in the next section.

Multi-period Extension

The nature of engineering tasks in aerospace PD is such that their duration usually extends over multiple planning cycles. To help decision makers take into consideration engineering tasks extending over multiple planning periods, a novel multi-period linear earned effort optimization model is developed below.

Assumptions for this model are similar to those of the mono-period model described in the previous section with the addition of a set of periods ($q \in Q$). Variables include (i) a new variable E_{ikq} that represents a decision maker estimate of hours required

to complete tasks ($i \in T$) for resources ($k \in K$) phased in periods ($q \in Q$); (ii) C_{kq} capacity of resource type ($k \in K$) in period ($q \in Q$); (iii) task value V_i of task $i \in T$, (iv) B_{pq} budget of project ($p \in P$) in period ($q \in Q$); (v) $\delta_{ip} = 1$ if task i is related to project p , otherwise $\delta_{ip} = 0$; (vi) $\delta_{ih} = 1$ if task i is an activity of type h , otherwise $\delta_{ih} = 0$; (vii) α_{hq} represents the minimum rate of completion for activity type h in period ($q \in Q$); (viii) β_{pq} represents the maximum rate of project p budget allocated in period ($q \in Q$); (ix) γ_{pq} represents the minimum rate of project p budget allocated in period ($q \in Q$); (x) P_{iq} represents the penalty associated with late (versus decision maker required E_{ikq}) resource allocation to task ($i \in T$) in period ($q \in Q$); (xi) decision variables include X_{ikq} , which represents the hours allocated to task ($i \in T$) from resource type ($k \in K$) in period ($q \in Q$) and; (xii) Y_{ikq} , which represents the earned effort in hours for task ($i \in T$) from resource type ($k \in K$) in period ($q \in Q$). Note the transition from the notion of realized value in the mono-period formulation, to a notion of earned effort in the multi-period formulation.

The mathematical formulation for the multi-period resource allocation decision making model is as follows:

The objective function is to maximize earned effort value, as follows:

$$\max \left(\sum_i \sum_q V_i \left(\sum_k Y_{ikq} \right) \right) - \sum_i \sum_q V_i P_{iq} \left(\sum_k X_{ikq} \right) \quad (43)$$

Subject to the following constraints:

Capacity constraint, $\forall (k, q) \in K \times Q$:

$$\sum_i X_{ikq} \leq C_{kq} \quad (44)$$

Earned effort, minimum (E,X): $\forall(i, k, q) \in T \times K \times Q$:

$$Y_{ikq} \leq E_{ikq} \quad (45)$$

$$Y_{ikq} \leq X_{ikq} \quad (46)$$

Respect estimated hours over planning horizon, $\forall(i, k) \in T \times K$:

$$\sum_q X_{ikq} = \sum_q E_{ikq} \quad (47)$$

Total budget constraint, $\forall q \in Q$:

$$\sum_i \sum_k X_{ikq} \leq \sum_p B_{pq} \quad (48)$$

Project budget constraint, $\forall(p, q) \in P \times Q$:

$$\gamma_{pq} B_{pq} \leq \delta_{ip} X_{ikq} \leq \beta_{pq} B_{pq} \quad (49)$$

Activity types constraints, $\forall(h, q) \in H \times Q$:

$$\sum_i \sum_k \delta_{ih} X_{ikq} \geq \alpha_{hq} \left(\sum_i \sum_k \delta_{ih} E_{ikq} \right) \quad (50)$$

Positivity constraints, $\forall(i, k, q) \in T \times K \times Q$:

$$X_{ikq} \geq 0 \quad (51)$$

$$Y_{ikq} \geq 0 \quad (52)$$

5.3.3 Short Term Resource Allocation Model

The output of the medium-term resource allocation problem results in a decision to allocate a given amount of resources to a given task over a medium-term planning horizon. However, in the short term, a decision must be made as to which specific

resource to allocate to which task. In order to address this problem, a proactive lean logistics short-term resource allocation model is developed in this section. This model enhances management decision-making effectiveness, helping to decide which job to allocate to what resources, given the complexity inherent in managing in an optimal manner the allocation of scarce engineering resources to design jobs of varying nature, complexity and priority. The demand for engineering resources is conveyed through a number of tasks or jobs. For some of these jobs of interest here, scarce value stream bottleneck resources must be assigned.

Assumptions are as follows: (i) from the medium term resource allocation problem, it has been decided to assign resources to a civil or military job ($j \in J$) with a given complexity level to satisfy its demand. (ii) Resources of different proficiency levels can be assigned to this job from the pool of available engineering resources ($e \in E$), each with limited capacity for the considered short-term planning horizon, and with clearance attributes indicating whether or not they are entitled to work on military type jobs. (iii) Each job entails setup time, and a given value or priority is assigned to the job.

Variables are as follow: (i) D_j represents the quantity of resources required to complete job j , or in earned value terms the estimated job cost; (ii) PR_j is a pre-determined variable that conveys the value or priority of task j ; (iii) C_e represents the capacity of engineer e in the considered planning horizon considered; (iv) CO_j represents the complexity of the job, with $CO_j = 1$ representing low complexity, and $CO_j = 2$ representing high complexity. (v) P_e represents the proficiency of engineer e , with $P_e = 1$ representing low proficiency, and $P_e = 2$ representing high proficiency (vi)

$CA_e = 1$ represents the clearance of engineer e for military work, otherwise $CA_e = 0$;
(vii) $Z_j = 1$ indicates a military type job j , otherwise $Z_j = 0$; (viii) S_j represents the setup time for job j ; (ix) X_{je} represents the effort to be spent by engineer e on job j ; (x) Y_{je} is a binary variable that is unity if $X_{je} > 0$, otherwise $Y_{je} = 0$; (xi) V_{je} represents the adjusted effort given task complexity CO_j and employee proficiency P_e , and its value is given by:

$$V_{je} = \frac{P_e X_{je}}{CO_j} \quad (53)$$

(xii) the decision variable $OUT_j = 1$ if the job demand D_j is satisfied, otherwise $OUT_j = 0$.

The key assumptions are that engineers (e) work sequentially, one design job (j) at a time. In addition, vacation time is considered for employees, such that their capacity is reduced for a given time horizon. Also, applicable regulations are considered in the assignment of jobs to engineers to determine for example whether employees have adequate clearance given the nature of the design job (e.g., military). The job complexity versus employee proficiency is considered and used to modulate the initial estimate of resource required (forecast). Different levels of job priority or value must be considered from field issues to operational priorities, cost reduction opportunities, new program development, and technology or process improvement. Each engineer working on the design job incurs setup, and finally, demand exceeds capacity.

The objective of the lean logistic model is to support the lean engineering objective by maximizing the number of jobs completed (throughput) with allocation of the most appropriate resources to jobs.

The objective function is:

$$\text{Max} \left(\sum_j \text{Out}_j * PR_j \right) \quad (54)$$

The following constraint is required to ensure that demand is met:

$$\sum_e V_{je} = D_j * Out_j + \sum_e y_{je} * S_j \quad (55)$$

The jobs being touched are identified as:

$$x_{je} \leq M * y_{je} \quad (56)$$

Regulations must be complied with:

$$y_{je} \leq 1 - Z_j + CA_e \quad (57)$$

Finally, capacity restriction must be considered:

$$\sum_j (x_{je} + y_{je} * S_j) \leq C_e \quad (58)$$

5.4 Results

In this section results from implementing the previously mentioned models are presented.

5.4.1 MAVT

Value dimensions and criteria for the case company are as indicated in Table 4 below. To reduce evaluation variability amongst decision makers, corresponding to different personal levels of risk aversion or risk taking inclinations, an anchored, Likert

type decision-making table using a short text to describe the criteria for each level is proposed.

Table 4. Engineering tasks value dimensions and criteria

Level	BUSINESS				SOCIETAL	ENVIRONMENTAL	Value (v)
	Customer impact	Criticality of issue	Work Progression	Impact on business			
None	No visible customer impact	Non-critical	(ACTUALS / ETC+ACTUAL) < 10%	No significant NPV benefit	No positive, or negative impacts on people and communities	Task has no impact on health and safety, and complies with public policies, plans and standards	v1
Low	Dispatch reliability above spec. No quality or performance issues. IFSD < 7 BUR < 20	Cost reduction, other	(ACTUALS / ETC+ACTUAL) > 10-40%	Incremental NPV benefit (NRE + Warranty + FSC) > 5-60K\$	Overall low positive on impacts on people and communities	Task addresses low impact on health and safety to help comply with public policies, plans and standards	v2
Med	MTBUR below spec Dispatch Reliability below spec 7 < IFSD < 10 70 < BUR < 200	Production, delivery issues	(ACTUALS / ETC+ACTUAL) > 40-60%	Incremental NPV benefit (NRE + Warranty + FSC) 50-250 K\$	Overall moderate positive impacts on people and communities	Task addresses moderate impact on health and safety to help promote compliance with public policies, plans and standards	v3
High	In flight shut down IFSD > 10 BUR > 200	Airworthiness safety reliability > 1	(ACTUALS / ETC+ACTUAL) > 60%	Incremental NPV benefit (NRE + Warranty + FSC) > 250K\$	Overall high positive impacts on people and communities	Task addresses high impact on health and safety to help support compliance with public policies, plans and standards	v4
Weight (w)	w1	w2	w3	w4	w5	w6	

From a business standpoint, expressing the influence of various factors in net present value (NPV) terms is useful, as it helps engineers and others involved in PD activities to understand the influence of their decisions on the business, while keeping the essence of the business case (such as costs, prices and profitability) confidential and away from most scrutiny.

Various dimensions can thus be related to each other via tradeoff curves, to establish the value of a main criterion (i.e., business impact). A typical lean decision-making tradeoff scorecard for a given engine model is shown in Figure 20 below, with hypothetical data that would be obtained from business case sensitivity curves. For example, an increase of five thousands dollars in factory standard cost (FSC) would yield a decrease of more than six millions dollars in NPV. Similar factors are provided for non-recurring cost (NRE), specific fuel consumption (TSFC), direct maintenance cost

(DMC), weight and delays in task delivery. These tradeoff factors assist in quantifying the “impact on business” criteria.

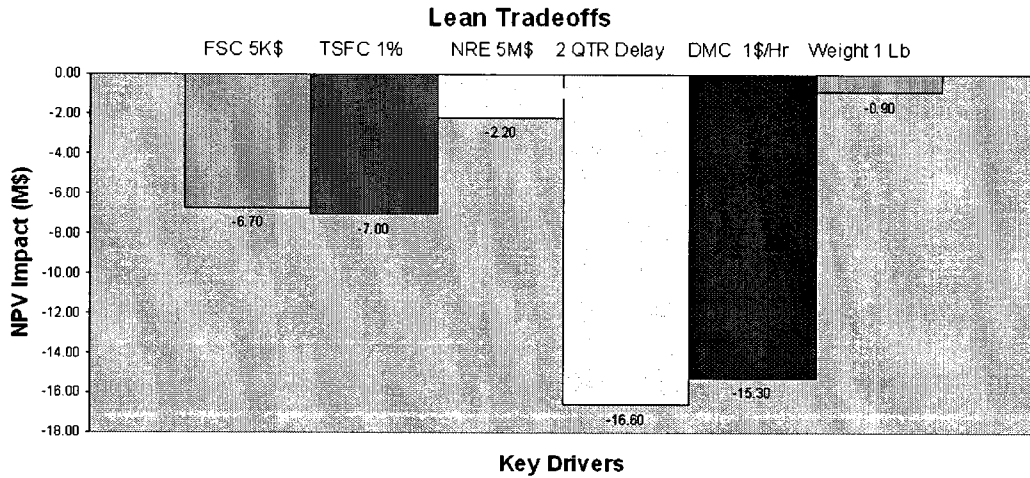

Figure 20. Lean decision making tradeoff scorecard

5.4.2 Medium-Term Resource Allocation

Mono-period Model

In a lean PD environment, value is realized upon task completion. A case study consisting of thirteen post-certification tasks was evaluated in four alternative decision-making environments with the resource allocation integer model implemented in Lingo®. As shown below in Table 5, there are benefits to be derived from the use of combined post-certification budgets and a job value index greater than unity. A full factorial DOE with $r=1$ replication was conducted for $k=2$ factors (budgets and value index) at $n=2$ levels (post-certification budgets constrained by project, or aggregated for all projects, and task value index at unity or unrestricted).

Factor “A” compared job resource allocation decision-making for pooled project budgets versus distinct project budgets, and factor “B” compared job resource allocation

decision making for unitary task value versus greater than one task value. Response variables were throughput and realized value (or implicit value for optimization using a unity value index). The decision-maker can use a unitary value for throughput maximization policy or greater than one job values for realized value optimization.

Results obtained showed that decision-making value improvement in excess of fifty percent could be realized when optimization considered entire post-certification budget and tasks rather than the local project based optimization approach with unity value index. This result is consistent with those previously discussed that were reported by Keisler (2009). The difficulty with achieving these results in real life stems from the unavailability of appropriate data to feed models, and lack of user sophistication to understand and use mathematical model. To a lesser extent the consideration of a value index different from unity also improved value realized between four to nine percent.

However, note that the use of unrestricted task value in decision-making resulted in ten percent less throughput than in the unitary task value case.

Table 5. Realized value and implicit value increase results

Factor		Response		BASE MODEL
A	B	Number of Jobs Completed	Value Realized (or implicit)	
Low	Low	10	531	} Implicit value 9%
Low	High	9	578	
High	Low	13	795	} Realized value 54%
High	High	13	817	

Factor A: Post Certification budgets (low - distinct, high - combined)

Factor B: value (low - unitary, high - greater than 1)

Extended Mono-period Results

Results from the extended mono-period model are essentially similar to those obtained from the previously discussed mono-period model when the minimum rate of completion of activity type h α_h , the maximum rate of completion of project p β_p and the minimum rate of completion of project p γ_p are all unity. These variables enable modulating resource allocation based on management explicit priorities for various projects, as well as for different task types, and offer greater flexibility to decision makers in how scarce engineering resource should be allocated.

Extended Multi-period Results

An industrial-sized case study involving over four thousands tasks, twenty five resource types and eight periods was conducted during an industrial research workshop at Université de Montreal Centre de Recherches Mathématiques. Using Mosel Xpress © linear solver, optimal results have been obtained within a minute of computing time.

Given the multi-period nature of this model, and the fact that the engineering personnel best understand how resources should be allocated to the task being looked at, a notion of earned effort value is developed. Thus, a key difference from the previous extended mono-period model is the shift from optimizing realized value, to that of optimizing earned effort value. Figure 21 below shows first that the estimated effort for a given task over the considered time periods (E_{ikq}) needs to be defined in the model, where E_{ikq} represents the project manager estimate of resources required for job i , engineering resource k and period q . This represents a beneficial shift from the company's operating practice, as activity dates are instead currently used for automatic

phasing of resources over time periods, which creates difficulty to modulate resource spread to user satisfaction.

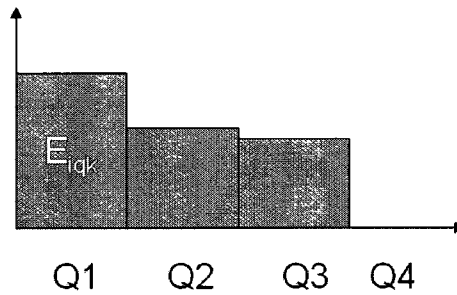

Figure 21. Estimated effort

As the multi-period model is run, resources are allocated to various jobs, possibly in different quantities and timing than what was initially established. Figure 22 below compares in light blue the allocated resources X_{ikq} to those initially estimated E_{ikq} in dark blue.

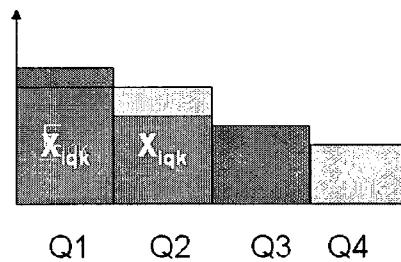

Figure 22. Comparison of estimated to allocated resources

A notion of earned effort, similar to that of earned value found in project management (PMI, 1996), is developed in the multi-period model. The earned effort is defined as the minimum of either the estimated effort or the allocated resources, and is shown pictorially in Figure 23 below in bright green.

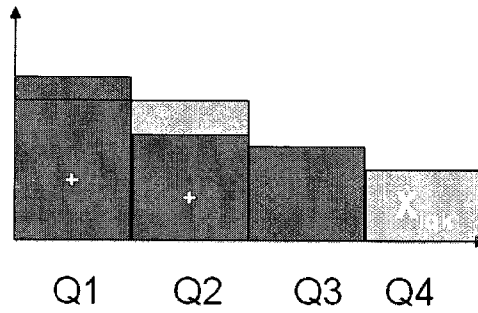

Figure 23. Positive earned effort

Incentives are provided in the objective function for the resources to be allocated at the earliest possible time, such as avoiding build up of IWIP. This is represented in red in Figure 24 below by the notional reduction in earned effort in the last quarter, where resources are allocated to the engineering task, while the estimate does not require any.

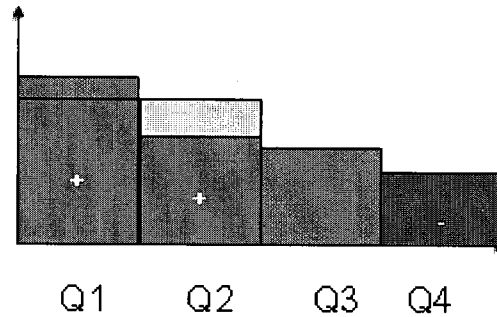

Figure 24. Earned effort penalty

The optimal earned effort value is provided for different levels of budget available, given that each engineering task has a pre-defined value from the MAVT model associated with it. Figure 25 below shows that the earned effort value decreases as more budget limitations are imposed.

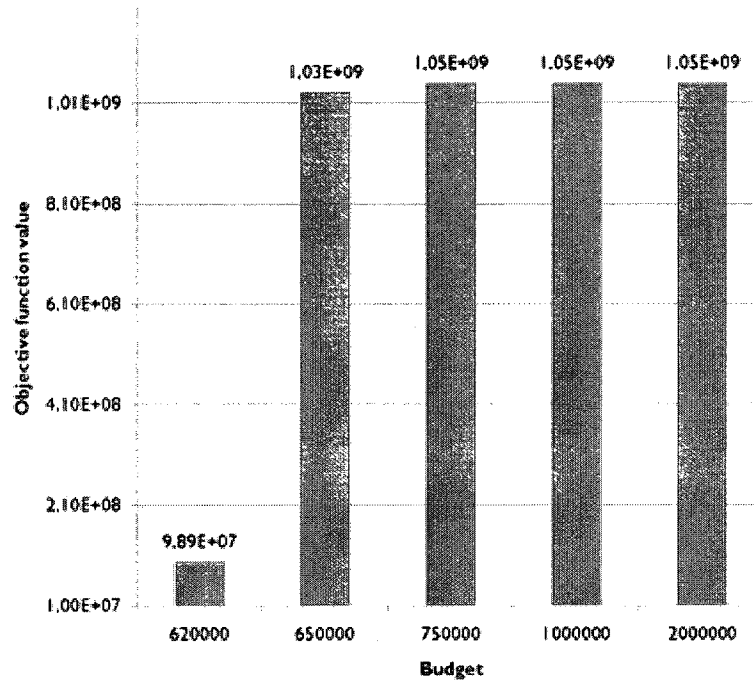

Figure 25. Earned Effort Value versus Budget

5.4.3 Short-Term Resource Allocation Results

Demand for engineering resources is captured via the P/S module of SAP, the enterprise resource planning system used by the case company. Demand is initially captured for high level planning packages following engineering cost estimation exercises. As detailed design activities are launched, further details are specified at the job level. A graphical interface to SAP P/S has been created to display demand, capacity and utilization level for various engineering activities (organization breakdown structure - OBS). Figure 26 below provides an illustration of the approach that was implemented for identifying demand. Data has been masked to preserve confidentiality. For the engineering organization called OBS1, there is a monthly engineering capacity of about 6000 hours. During Year 1, the aggregated monthly demand arising from planning

packages and jobs is well below the available capacity, resulting in a utilization level that does not exceed 100%, thus providing sufficient capacity to respond to unplanned events. During Year 2 however, monthly utilization levels in excess of 120% indicate that this OBS could become a bottleneck, if no improvements are made. The notion of forecast visibility is introduced in the figure below, as the ratio of demand on jobs over demand on jobs plus planning packages, and it can be seen that the forecast visibility decreases over time.

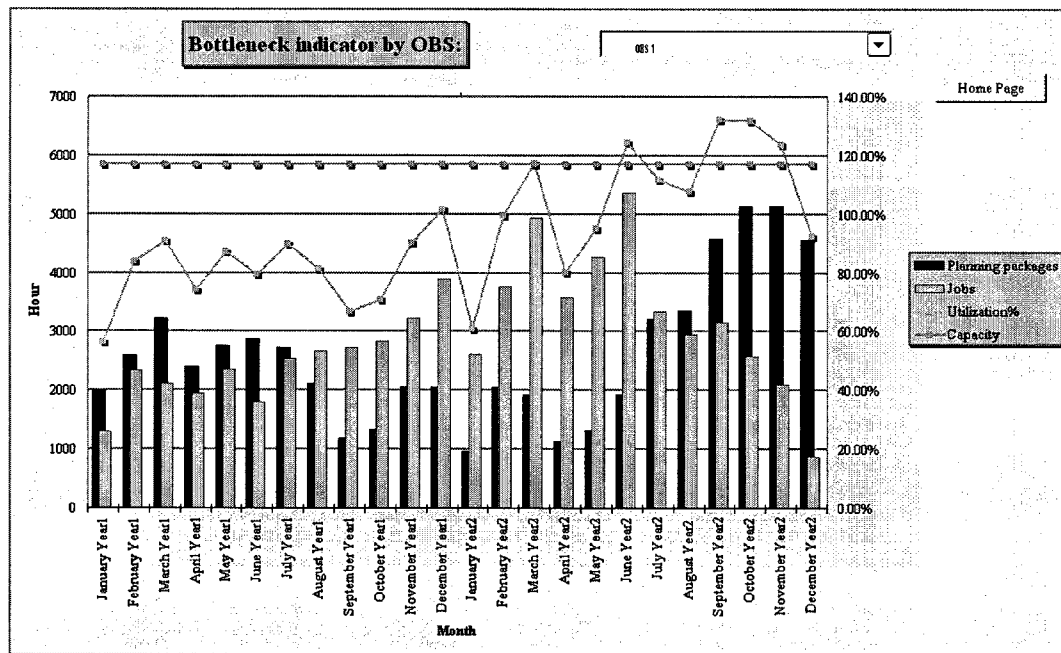

Figure 26. OBS demand

The short-term lean engineering resource allocation model has been tested during a lean engineering logistics training session through a game consisting of a simulated simplified dataset of 12 jobs and 4 engineers (see Table 6 below). These jobs were considered for completion in the next 12 week time horizon. Job requirements indicated how many weeks of effort were required to complete the job. A job complexity of 1 indicated a low complexity job, whereas a value of 2 indicated a high complexity one.

Regulation (CGRP) of 1 indicated that a job could only be worked on by a resource having received appropriate clearance (i.e., CGRP of 1 for the engineer), while a value of 0 would not pose any constraint on the type of personnel executing the job. A value or priority of 1 was indicative of low priority, whereas a priority of 3 suggested higher priority.

Table 6. Lean engineering logistics game dataset

Team _____

$$\% \text{ Jobs Completed} = \frac{100 * \text{No. Job Completed}}{12}$$

Plan : number of weeks worked on job by employee

Employee #	Job #												Total	Cap	CGRP	PROF	
	1	2	3	4	5	6	7	8	9	10	11	12					
1															12	1	2
2															11	1	1
3															12	0	2
4															12	1	2
Total Wks allocated																	
Job Requirement	14	6	4	8	2	4	2	8	2	2	2	2					
Job Complexity	1	2	2	1	1	2	1	2	1	2	2	2					1 low 2 high
Regulation (CGRP)	0	0	0	0	1	0	0	0	1	0	0	0					
Priority	3	2	1	2	1	1	3	3	1	1	2	3					1 low 3 high
Job Completed?															12?		

The short-term resource allocation model results for the above case study dataset are provided in Table 7 below. According to the model, a maximum of 11 out of the 12 jobs could be completed in the next planning horizon using the data provided. Each resource had a capacity of 12 weeks. All except resource 3 had CGRP clearance to work on regulated jobs. All resources except resource 2 had high proficiency. In the case study performed, the highly proficient resource 1 completed low complexity job 1 in 7.05 weeks, consistent with the model described in the previous section and with an effective setup time of 0.05 week.

Table 7. Optimal lean engineering logistics model results

				Good Plan Jobs													
				1	2	3	4	5	6	7	8	9	10	11	12	TOTAL	
ETC (wks)				14	6	4	8	2	4	2	8	2	2	2	2		
Complexity				1	2	2	1	1	2	1	2	1	2	2	2		
Regulation				0	0	0	0	1	0	0	0	1	0	0	0		
Priority				3	2	1	2	1	1	3	3	1	1	2	3		
Resource	Proficiency	CAP	CGRP	VOL													
1	2	12	1	7.05	3.98											0.98	12
2	1	11	1			8.1				0.5	2.25				10.9		
3	2	12	0			4.05		7.85					11.9				
4	2	12	1	4.03	1.03	1.03	1.03	1.03	2.05	2.05			11.2				
Completed				1	0	1	1	1	1	1	1	1	1	1	1	11	

These results were compared to those results obtained by teams of experienced project managers during a lean engineering and project management training session conducted at McGill University. Key differences between how teams scheduled design jobs have been observed during this training session. Teams used either due dates, processing time, job complexity, or type of jobs as a basis for scheduling, which gave rise to varying levels of performance when compared to the optimal model output. The inconsistency in results obtained from the above mentioned experiment reinforces the idea that short-term resource allocation optimization models and prioritization tools would be required to improve the consistency and performance of lean engineering, and effectiveness of decision making. Figure 27 below provides a good sequence that shows the order in which the 11 jobs could be performed.

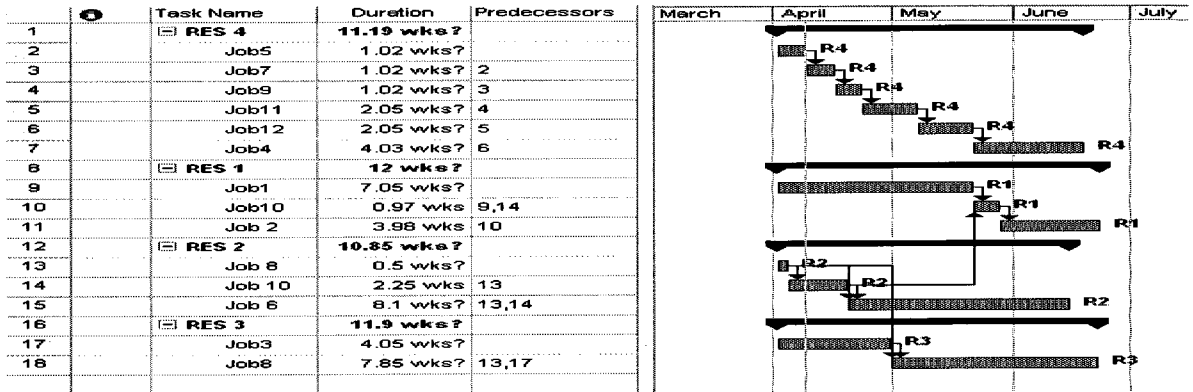

Figure 27. Reasonable Schedule

5.5 Discussion

In this section a discussion of results obtained for the MAVT model as well as medium term and short term optimization models is provided. It should be noted that further change management work is required to fully implement these models in the case company, and make any necessary adjustments.

5.5.1 MAVT

The value optimization project has received support from the case company engineering executive management, and a phased pilot implementation is considered. The next step is to establish engineering task value.

Future work involves implementing in a first phase the multi-attribute value models in selected areas, establishing appropriate weights, and developing training packages such that project managers and engineers get more familiar with the approach used in the engineering task multi-attribute value models.

5.5.2 Medium-Term

Spreading available resources on too many tasks may decrease the level of focus of employees, and might unduly impact the PD system lean performance by extending task lead time. Interviews at the company have revealed that management of activities conducted in the post-certification domain is difficult due to the lack of prioritization on tasks, and the absence of a quantitative model to optimize realized value. Discussions with project managers have also revealed the need for a consistent prioritization approach to support the selection of engineering tasks. The medium-term resource allocation models described previously has been discussed with the case company management; however, further work in terms of a pilot test remains to be done to provide convincing arguments for the appropriateness of these optimization approaches. The case company engineering management is generally quite aware that appropriate allocation of resources is an important factor for successful PD. The medium-term model will enable arbitration between the various decision makers and projects, and moves away from the situation where the one that shouts the loudest gets the resources.

One of the challenges associated with the solutions outlined in the mono-period decision making models is the fact that they rely on integer linear programming optimization approaches, that are NP hard, and thus limited to smaller problems, given the high number of alternatives that have to be investigated by the branch and bound solution approach (Hillier, Lieberman, 2005). The possibility of using a finite capacity scheduler has been raised, and requires additional analysis to determine in practice how this approach would satisfactorily address various stakeholders' demands and various engineering groups ability to address multi-project demands and optimal value based

resource allocation decision making. While not an optimum solution, the finite capacity scheduler solution should be near optimum, and should overcome the computation problem noted previously. A work by Belhe and Kusiak (1996) and another by Jin and Thomson (2003) proposed the use of a limited time horizon for determining schedules for engineering activities, thus mitigating the NP hard characteristic of the problem.

The research that was conducted in cooperation with a team from École Polytechnique led to the development of a linear multi-period model with solution space not restricted to the integer domain, which provided results within a minute of computing time for an industrial sized problem.

A key challenge with this planning cycle includes the high effort and lead time required to agree on a task list that will provide for a balanced budget. Many weeks of effort and multiple reviews are required from multiple stakeholders to reduce the imbalance between available budget and required resources to complete the desired task list. At the end of this exercise, some imbalance in terms of higher demand than available budget, sometimes at the expense of the management reserve, remains. This is critical as imbalance from this exercise results in overloading of the PD system, and in tasks that do not get completed due to lack of resources. Proponents of agile PD understand from queuing theory the great consequences of these higher utilization levels on lead time and flow of information, with as much as eleven times increase in waiting time observed from an eighty percent loading of the PD system (Smith, 2007).

5.5.3 Short-term

The implementation of a short-term optimization model such as the one contemplated in the previous section relies on adequate visibility and accuracy of

forecasted resource requirements. From a practical standpoint, the first issue relates to the available, low current levels of forecast visibility, and thus, to the low quality of data available to decision makers. As with any enterprise resource planning system, there is notionally a maximum of data defects above which quality decision making is more difficult. Recommendation from Sipper and Bulfin (1997) suggests a minimum of ninety-two percent accuracy in ERP records such as bill of materials and inventory values for manufacturing implementations, such that the system produces believable and useful information. In a similar fashion, data from engineering value streams containing bottlenecks must possess a high level of accurate information before implementing the short-term resource allocation optimization approach. Some quality of data improvement efforts are recommended in the company before implementation of the optimization model. Implementation of the short-term resource allocation optimization model requires a quality of data, as measured by a six sigma metric called defects per million opportunities (DPMO), of less than 80K. Potential items to consider for enabling the implementation of lean engineering logistics include addressing data defects such as 'Missing Ownership – Projects or Design', 'Invalid Forecast Finish Date – Date in the past', 'No ETC in the Resource Screen', and 'No Baseline' situations.

The second issue to address is the material differences noted between design job forecast and actual resources expended. System dynamic analysis has shown that the ability of the product development system to recover from quality issues and rework is compromised past a given threshold, the tipping point (Repenning, Black, Goncalves, 2001). This point may be defined in terms of a percent utilization of the bottleneck process in the PD system. The proposed short-term resource allocation model needs to

take this systematic low balling bias factor into consideration, so as to avoid over commitment of resources past the tipping point, and the situation depicted by Reppenning, Black and Goncalves (2001) where rework and late delivery issues eventually lead to the failure of the PD system. Improved consistency in estimating resources for engineering tasks would be required to address the above mentioned item. This problem manifests itself either in the actual amount of work being different from what was forecasted, or from the appearance of new, unplanned tasks. These so called “walk-ins” comprise unplanned tasks that suddenly arise, unexpectedly. Unplanned allocation of personnel in PD is a common phenomenon in a multi-project PD organizations, and should be taken into consideration when deciding upon allocation of resources to engineering tasks.

The idea of implementing the short-term resource allocation concepts has met some resistance. Some of this might be attributed to the lack of sharing and knowledge of documented successes in the implementation of such approaches in the aerospace engineering area. Further research in this area would be required to improve awareness of potential benefits, known pitfalls and difficulties in designing and making operational engineering production systems around these concepts.

A possible additional reason for the current lack of support of this optimization approach may be related to the traditional functionally oriented organizational structure. The current engineering structure is functionally oriented. The high utilization organization being worked with is a service organization, supporting multiple core design functions. The current perception is that it is politically difficult for this organization to have a visible impact on the decisions to start design jobs or not. As discussed earlier,

further work evaluating the benefits associated with the implementation of a backlog stage in the engineering job release decision process is required, and has recently started.

5.6 Conclusions

Recognizing the need to align multiple stakeholders on an optimal use of the scarce PD resources to achieve best value, a multi-attribute value model is initially developed to provide a consistent basis on which to prioritize engineering tasks in the case company PD system. Efforts implementing this approach are ongoing at present.

Medium term-resource allocation optimization models with gradual, incremental sophistication have been developed to help support optimal resource allocation decision-making. A simple engineering resource allocation, linear integer model incorporating the various dimensions of post-certification decision making was developed. A case study showed that consideration of the multi-faceted dimensions of value in engineering post-certification activities led to enhanced value. A novel multi-period engineering task earned effort linear optimization approach was then developed in this research to solve the medium-term resource allocation problem. Following this, the short-term problem associated with deciding which specific resource to allocate to which task was solved with the short-term resource allocation optimization model, with the understanding that different resources and tasks have varying levels of proficiency and clearance, requirements and complexity, with best matching required for optimum PD system output.

Developing and implementing a methodology to optimize resource allocation in engineering PD operations is a worthwhile exercise that supports customer satisfaction, increases shareholder value and employee satisfaction. The research work performed

thus far points to the need for additional change management effort in the implementation of the proposed models and approaches, such as to increase their level of acceptance and understanding in the case company.

6. Conclusions and Future Directions

The Canadian aerospace industry is looking for ways to enhance its productivity and effectiveness from its R&D investment in product development. Competition from foreign countries is fierce, and in civil applications, delocalization of product development activities to lower wage countries is in progress. The research reported in this thesis supports Canadian businesses achieving higher levels of excellence by establishing novel lean engineering multi-criteria performance measurement models for entities active in product development, by developing both analytical and experimental product development optimal job sizing approaches, and by designing multi-attribute value models and resource allocation decision-making optimization models, for both medium and short-term.

A summary of the key contribution from the research conducted on the PD system is provided below. The research has successfully addressed key elements of PD information value and flow through the development of novel optimization models addressing both the definition of value through use of a multi-attribute value theory approach, and optimization of value through a medium-term realized value optimization model, an earned effort resource allocation optimization model, and a short-term task engineering assignment optimization model. Analytical and simulation models have been developed to study the influence of job size and other key items such as concurrency and focus on the performance of the PD system, in term of lead time (flow), waste and other measurements.

6.1 Summary

Most of the previous research in lean engineering has not addressed the following critical questions related to the application of lean techniques in aerospace product development activities a) the question of performance measurement to ascertain the benefits gained by lean, in terms of information value flow in PD, b) the determination of optimal job size and its influence on key PD system performance parameters including information value flow, and finally c) the influence of resource allocation decision-making on the performance of the PD system.

The objectives set forth in the introduction are as follows:

1. To develop and validate a lean engineering multi-criteria performance measurement model, that will support the lean goal of improving the information value flow in PD by reducing span time. A novel engineering taxonomy of post-certification tasks is also developed to validate the performance model, through value streams comparisons.
2. To develop an analytical model and a discrete event simulation approach in order to establish an optimal engineering job size, leveraging the engineering performance model developed in the first part.
3. To develop lean decision-making support models for optimal allocation of PD resources, supporting the overarching objective of flow of information value.

Key contributions from this thesis are summarized in the next section.

6.1.1 Multi-Criteria Lean Engineering Performance Model

In Chapter 3, the objectives were to develop and validate a lean engineering multi-criteria performance measurement model, supporting the lean goal of improving the information value flow in PD by reducing span time.

A significant contribution of Chapter 3 is the development of a novel lean engineering multi-criteria performance measurement model. To validate the model, a novel engineering taxonomy of post-certification tasks is also developed, and extensive data gathering and analysis of different PD value streams was conducted.

A comprehensive and detailed descriptive statistics analysis of the acquired data was performed, and served as the basis for the development of the discrete event simulation model. High levels of concurrency are observed in the selected value stream, and as a result, concurrency is selected as a key factor to be incorporated in the job sizing model.

Important differences between pre-certification and post-certification value stream performance are noted, particularly with respect to flow as measured by average job lead time, and waste associated with setup and non-touch day charges. The significant difference observed in the level of focus between the value streams provides the required motivation to incorporate this factor in the job sizing model development.

Important findings from this research include the fact that the multi-criteria lean engineering performance model provides a critical ability to benchmark and study different PD value streams, and supports the ability of various interested parties to see the available opportunities for improvement: lacking any justification or visibility of

potential improvements, the status quo would inevitably install itself with a resulting lack of progress.

The lean engineering performance model also enables the translation of value stream improvements into dollar values, which is of utmost importance to management, as business decisions are usually driven mostly by monetary considerations, a universally understood language.

The lean engineering performance model was implemented in the case company with the yearly improvement objectives set forth for the PD system achieved, and the model was validated by comparing the performance of diverse value streams. Taylor's (2005) call for a model to clearly and consistently evaluate the benefits afforded by lean improvement has been satisfactorily addressed here. The objectives set forth for this part of the research are thus achieved.

6.1.2 Optimal Engineering Job Size

Building on the solid foundations established in the previous section, the objective of Chapter 4 was to develop an analytical model and a discrete event simulation approach in order to establish an optimal engineering job size, leveraging the engineering performance model developed in the first part.

The development of an experimental discrete event simulation (DES) model was undertaken to study the influence of job size on the lean engineering performance of the PD system. The DES uses detailed statistics obtained from the benchmarking study performed in Chapter 3. An important design of experiment (DOE) is performed as well, to validate the significance of factors such as concurrency and focus level on key PD system lean engineering performance such as lead time and waste.

Significant contributions from the research conducted with the DES models and DOE analysis are the ability to highlight the influence of job size on the PD system performance with decreasing waste to job size, and a convex job size to lead time relationship observed. In addition the DES and DOE models helped confirm the significance of PD concurrency level and engineer focus level on PD performance measures of lead time and waste. These factors were thus incorporated in the development of the analytical model discussed next.

Another significant contribution from this research includes the development of a simple, yet comprehensive analytical formulation for the determination of optimal job size in engineering PD, incorporating key characteristics of PD systems, such as levels of concurrency and focus on PD performance measures of lead time and waste. Thus a key contribution from the cost minimization approach set forth in the analytical model is to extend the seminal work in the manufacturing world from Harris (1990) to the PD domain, providing the required flexibility for professionals to study the influence of various configurations of focus, concurrency and waste on the economic design quantity (EDQ), as well as on the total relevant cost (TRC) of the PD system, providing stronger foundation for further research into the resolution of the once elusive notion of 'one piece flow' for engineering work in the PD domain.

6.1.3 Engineering PD Value Optimization

In Chapter 5 the objective was to develop lean decision-making support models for optimal allocation of PD resources, supporting the overarching objective of flow of information.

The motivations for this part of the research included the following:

1. An absence of an integrated resource allocation approach adapted to the specificities of PD.
2. The size limitation problem of current exact integer linear programming optimization solution approaches.
3. The performance issues associated with solving industrial-sized meta-heuristic resource allocation problems.
4. The inconsistency amongst decision makers associated with deciding which task to prioritize and work on.
5. The lengthy duration of the planning cycle observed in the case company with uncertain outcomes and benefits.
6. The lack of an integrated approach in the background material reviewed.

The decision-making inherent in deciding to release an engineering job to the PD floor is tackled via the development of a multi-attribute engineering job value model, associated with medium and short-term resource allocation optimization models. Such a multi-attribute engineering task value model (MAVT) supports a consistent quantification of value, and determine tasks that are of high enough value to compete for allocation of scarce PD resources.

The optimal allocation of PD resources is achieved via novel realized value and earned effort optimization models for the medium-term problem, and throughput maximization models for the short-term problem. Benefits to be derived from the short-term resource allocation model has been validated through a project management training event at McGill University in terms of more consistent decision-making and improved throughput. The adequacy of dimensions and criteria used in the multi-attribute value

assessment of engineering tasks has also been validated through workshops with project managers and engineers. The case company has also demonstrated significant interest for the concepts established in this part of the research.

Given the objectives set forth at the beginning of developing lean decision-making to support optimal allocation of PD resources, the objective set forth in this part of the research is thus achieved.

6.2 Future Directions

In this section, avenues for future work are discussed in each of the three research areas of the thesis.

6.2.1 Multi-criteria lean engineering performance model

The objective here was to establish a model to ascertain the performance of PD activities. Throughout the extensive data gathering exercise that this research necessitated, the determination of redo waste data remained difficult to obtain. Better understanding of rework waste influence on PD performance is thus required, in terms of its relationships with concurrency, focus, and associated job size.

6.2.2 Optimal engineering job size

The objective was to establish among others an experimental model to ascertain the influence of job size on the performance of the PD system. Given limitation issues associated with the version of the simulation package used, significant departures between actual and experimental results were observed. This correlation issue between experimental results from discrete event simulation and actual results obtained from

gathered data should be addressed, and redo waste factors as identified previously incorporated into the model.

Another objective was the development of an analytical model to determine the optimal job size. While this has been achieved, the fact remains that under conditions of high utilization correction factors to account for the queuing effect and associated results in lead time and IWP should be added to the EDQ model. Incorporation of the relevant correction factors in the EDQ analytical model would address the non-linear relationship between utilization and lead time claimed by Smith (2007).

6.2.3 Engineering PD value optimization

The objective here was to develop lean decision making support models for optimal allocation of PD resources, supporting the overarching objective of flow of information value. Proper weights for the multi-attribute value criteria have to be established, with care exercised to ensure that the proposed weight are non-linear value functions to overcome the fully compensatory feature of MAVT.

As noted above, future work should enhance the research conducted in this thesis in a number of ways. Of critical importance will be better definition and characterization of waste in the lean engineering multi-criteria performance model, in terms of its impact on key PD factors, above and beyond the qualitative aspects generally considered. This work should enable a complete and detailed treatment of the various components of this very important factor, much beyond what has been possible in this thesis. Another area for further detailed work, as was noted in the introduction, is the integration of PD job sequencing considerations, to address the important question of optimal job sequencing.

Bibliography

- AER07, 2007, "Aero Conference and 54th Annual General Meeting - Aerospace in Canada: Research and innovation for the global market place" [CD-ROM] Toronto.
- Aral, S., Brynjolfsson, E., Van Alstyne, M., 2007, "Information, technology and information worker productivity: task level evidence", National Bureau of Economic Research.
- Arbulu, R., Tommelein, I., Walsh, K., Hershauer, J., 2003, "Value stream map analysis of a re-engineered construction supply chain", *Building Research and Information*, 31(2), pp.161-171.
- Barzilai, J., 2008, "Preference Function Modeling (PFM): The Mathematical Foundations of Decision Theory," Technical Report, Dept. of Industrial Engineering, Dalhousie University, pp. 1-16.
- Bashir, H. A., Thomson, V., 2004 "Estimating Design Effort for GE Hydro Projects", *Computers and Industrial Engineering*, 46, pp. 195-204.
- Beaugregard, Y., Thomson, V., Bhuiyan, N., 2008, "Lean engineering logistics: load leveling of design jobs with capacity considerations", *Canadian Aeronautical and Space Journal*, 54(2), pp. 19-33.
- Beitz, A., Wiecek, I., 2004, *Applying benchmarking to learn from best practices*, Springer.
- Belhe, U.D., Kusiak, A., 1996, "Scheduling design activities with a pull system approach". *IEEE Transactions on Robotics Automation*, 12(1):15-21.
- Berkoune, D., Mesghouni, K., Rabenasolo, B., 2006, "Resolution approach for multi objective scheduling problem with uncertain demand", *IMACS Multiconference on Computational Engineering in Systems Applications (CESA) October 4-6, Beijing, China*, pp 1465-1471.
- Blackburn, C., Valerdi, R., 2009a, "Practical implementation of an enterprise measurement system: from inception to transformation", 7th Annual conference on system engineering research 2009 (CSER), Loughborough University.
- Blackburn, C., Valerdi, R., 2009b, "Navigating the metrics landscape: an introductory literature guide to metric selection, implementation, & decision making", 7th Annual Conference on System Engineering Research 2009 (CSER), Loughborough University.
- Braglia, M., Carmignani, G., Zammori, F., 2006, "A new value stream mapping approach", *International Journal of Production Research*, October 2006, pp. 3929-3952.
- Browning, T., 2000, "Value based product development: refocusing lean", *Engineering management society, Proceedings of the 2000 IEEE*, pp. 168-172.
- Buchheim, R.K., 2000, "Developing performance metrics for a design engineering department", *IEEE Transactions on Engineering Management*, 47(3), pp. 309-320.
- Campbell, H.G., Dudek, R. A., Smith, M. L., 1970, "A Heuristic Algorithm for the of the 'N' job 'M' Machine Sequencing Problem", *Management Science*, 16, B630-637.

- Chan, P., Hiroux, M., Weil, G., 2006, "Strategic Employee Scheduling", PATAT, 2006, pp. 157-166.
- Chang, J.H., Chiu, H.N., 2005, "A comprehensive review of lot streaming", *International journal of production research*, 43(8), pp. 1515-1536.
- Chase, J. 2000, "Measuring value in product development" [online]. [Accessed June 08 2008]. Available from World Wide Web: < Lean aerospace institute, working paper http://lean.mit.edu/index.php?option=com_docman&task=cat_view&gid=78&Itemid=332>.
- Chiesa, V., Frattini, F., Lazzarotti, V., Manzini, R., 2007, "Measuring performance in new product development projects: a case study in the aerospace industry", *Project Management Journal*, 38(4), pp. 45-59.
- Clark, K.B., Fujimoto, T., 1988, *Product development performance*, Harvard Business School.
- Conradi, R., Westfechtel, B., 1998, "Version Models for Software Configuration Management", *ACM Computing Surveys*, 30(2), pp. 232-282.
- Cooper, R.G., Edgett, S.J., Kleinschmidt, E.J., 2001, *Portfolio management for new products*, Perseus.
- Cooperrider D. L, Whitney, D., Stavros, J.M., 2008, "Appreciative Inquiry Handbook for Leaders of Change", Crown Custom Publishing, Brunswick (OH).
- DeToni, A., Tonchia, S., 1996, "Lean organizations, management by process and performance measurement", *International Journal of Operations and Production Management*, 16(2), pp. 221-236.
- Dowden, T. D., 2005, "Exercising a multi-attribute value method for business airplane product assessment", 43rd AIAA Aerospace Sciences Meeting and Exhibit - Meeting Papers, pp. 8757-8769.
- Driva, H., Pawar, K.S., Menon, U., 2000a, "Measuring product development performance in manufacturing organizations", *International Journal of Production Economics*, 63 (200), pp. 147-159.
- Driva, H., Pawar, K.S., Menon, U., 2000b "Performance evaluation of new product development from a company perspective", *Integrated Manufacturing Systems*, 12(5), pp. 368-378.
- Murman, E., Allen, T., Bozdogan, K., Cutcher-Gershenfeld, J., McManus, H., Nightingale, D., Rebentisch, E., Shields, T., Stahl, F., Walton, M., Warmkessel, J., Weiss, S., Widnall, S., 2002, *Lean enterprise value: insights from MIT's lean aerospace initiative*, Palgrave.
- Finchbaugh, J., 2006, *The hitchhiker's guide to lean: lessons from the road*. Dearborn, Michigan: Society of Mechanical Engineers.
- Frost, R. B., 1994, "A suggested taxonomy for engineering design problems", *Journal of Engineering Design*, 5(4), pp. 399-410.
- Gebala, D. A., Eppinger, S. D., 1991, "Modeling the impact of organizational structure on design lead time and product quality" [online]. Available from World Wide Web: <<http://ideas.repec.org/s/mit/sloanp3.html>>.
- Georgy, M.E., Chang L., Zhang, L., 2005a, "Utility-Function Model for Engineering Performance Assessment", *Journal of Construction Engineering and Management*, 131(5), pp. 558-568.

- Georgy, M.E., Chang, L., Zhang, L., 2005b, "Prediction of Engineering Performance: A Neurofuzzy Approach", *Journal of Construction Engineering and Management*, 131(5), pp. 548-557.
- Gilland, W.G., 2001, "Effective sequencing rules for closed manufacturing networks", *Operations Research*, 49(5), pp. 759-770.
- Goldratt, E.M., Cox, J., 1992, *The goal: a process on ongoing improvement*, North River Press.
- Gouel, P., 2007, "Unwrapping front-loading: explaining problem solving performance in complex product development", PhD thesis, University of Michigan.
- Grewal, C.S., Enns, S.T., 2008, "Lot Size Optimization using M/G/n Approximations under Pooled and Unpooled Scenarios", *Proceedings of the 2008 Industrial Engineering Research Conference*, pp. 1361-1366.
- Griffin, A., Page, A.L., 1996, "PDMA success measurement project: recommended measures for product development success and failure", *Journal of Product Innovation Management*, 13, pp. 478-496.
- Hammer, M., Champy, J., 2003, *Reengineering the corporation: a manifesto for business revolution*, HarperCollins.
- Hammond, J.S., Keeney, R.L., Raiffa, H., 1998, "Even swaps: a rational way for making trade-offs", *Harvard Business Review*, 76(2), pp. 137-150.
- Haque, B., James-Moore, M., 2004, "Applying lean thinking to new product introduction", *Journal of Engineering Design*, 15 (1), pp. 1-31.
- Harris, F.W., 1990, "How many parts to make at once", *Operations Research*, 36(6), pp. 947-950.
- Harris, F.W., 1919, "How many parts to make at once", *The Magazine of Management*, 10(2), pp. 135-136, 152.
- Hauser, J.R., Katz, G.M., 1998, "Metrics: you are what you measure!", *European Management Journal*, 16(5), pp. 517-528.
- Higgins, R.C., 1998, *Analysis for Financial Management*, Boston: Irwin/McGraw-Hill
- Hillier, F.S., Lieberman, G.J., 2005, *Introduction to operations research*, McGraw-Hill.
- Hines, P., 2006, "Towards lean product lifecycle management: A framework for new product development" [online]. Available from World Wide Web: <<http://www.emeraldinsight.com/Insight/ViewContentServlet?Filename=Published/EmeraldFullTextArticle/Articles/0680170701.html>>.
- Hines, P., Found, P., Griffiths, G., Harrison, R., 2008, *Staying lean: thriving, not just surviving*, Lean Enterprise Research Center.
- Hoppman, J., Rebentisch, E., Dombrowski, U., Zahn, T., 2009, "Efficient Introduction of Lean in Product Development Results of the Survey", *Lean Advancement Initiative*, Massachusetts Institute of Technology, and Institute for Manufacturing and Operations Research, Technical University of Braunschweig.
- Jayaram, J., Vickery, S., Droge, C., 2007, "Relationship building, lean strategy and firm performance: an exploratory study in the automotive supplier industry", *International Journal of Production Research*, 46(20):5633-5650.

- Jin, G., Thomson, V. 2003, "A new framework for MRP systems to be effective in engineered-to-order environments", *Robotics & CIM*, 19 pp. 533-541.
- Kaplan, R.S., 1983, "Measuring manufacturing performance: a new challenge for managerial accounting research", *Accounting Review*, 58(4), pp. 686-705.
- Kara, S., 2000, "A simulation approach to project planning in multi-project concurrent engineering environment", PhD Thesis, University of New South Wales.
- Keisler, J.M., 2009, "The Value of Assessing Weights in Multi-criteria Portfolio Decision Analysis", *Journal of Multi-Criteria Decision Analysis*, 15, pp. 111-123.
- Kennedy, M., 2003, *Product Development for the Lean Enterprise: Why Toyota's System Is Four Times More Productive and How You Can Implement It*, Richmond, Virginia: Oaklea press.
- Kouskouras, K.G., Georgiou, A.C., 2007, "A discrete event simulation model in the case of managing a software project", *European Journal of Operational Research*, 181, pp. 374-389.
- Kratzer, J., Gemunden, H.G., Lettl, C., 2008, "Balancing creativity and time efficiency in multi-team R&D projects: the alignment of formal and informal networks", *R&D Management*, 38(5), pp. 538-549.
- Lander, E., Liker, J.K., 2007, "The Toyota production system and art: making highly customized and creative product the Toyota way", *International Journal of Production Research*, 45(16), pp. 3681-3698.
- Liker, J.K., 2004, *The Toyota way*, McGraw-Hill.
- Love, P.D., Edwards, D.J., Irani, Z., 2008, "Forensic project management: an exploratory examination of the causal behavior of design induced error", *IEEE Transactions on Engineering Management*. 55 (2), pp. 234-247.
- MacKenzie, S. A., 2006, "Utilizing Value Stream Mapping in Air Force Acquisition Program Offices", Master thesis, MIT.
- Mascitelli, R., 2007, "Design's due process", *Industrial Engineer*. 39(4), pp. 38-43.
- Mavrotas, G., Trifillis, P., 2006, "Multi-criteria decision analysis with minimum information: combining DEA with MAVT", *Computers & Operations Research*, 33, pp. 2083-2098.
- McManus, H. L., 2005, *Product Development Value Stream Mapping (PDVSM) Manual 1.0*, Lean Aerospace Initiative.
- McManus, H., Haggerty, A., Murman, A., 2005, "Lean Engineering: Doing the right thing right", 1st International Conference on Innovation and Integration in Aerospace Sciences 4-5 August 2005, Queens University, Belfast.
- MIT Lean Aerospace Institute, <http://lean.mit.edu/>.
- Morgan, J.M., 2002, "Applying lean principles to product development" [online]. [Accessed 8th June 2008]. Available on World Wide Web: <<http://www.sae.org/topics/leanfeb02.htm>>.
- Morgan, J.M., Liker, J.K., 2006, *The Toyota product development system*, Productivity Press.
- Murman, E., Allen, T., Bozdogan, K., Cutcher-Gershenfeld, J., McManus, H., Nightingale, D., Rebenstish, E., Shields, T., Stahl, F., Walton, M., Warmkessel, J., Weiss, S., Widnall, S. 2002. *Lean enterprise value: insights from MIT's lean aerospace initiative*. New-York: Palgrave.

- Narahari, Y., Viswanadham, N., Kumar, V. K., 1999, "Lead Time Modeling and Acceleration of Product Design and Development", *IEEE Transactions on Robotics and Automation*, 15 (5), pp. 882-896.
- Ngo-The, A., Ruhe, G., 2009, "Optimized Resource Allocation for Software Release Planning", *IEEE Transactions on Software Engineering*, 35(1), pp. 109-123.
- Office des Technologies Industrielles. (2007) [online]. [Accessed 8th June 2008]. Available on World Wide Web: <http://ito.ic.gc.ca/epic/site/ito-oti.nsf/fr/h_00095f.html>.
- Ohno, T., 1988, *Toyota Production System Beyond Large-Scale Production*, Productivity Press.
- Oppenheim, B., 2004, "Lean product development flow", *Systems Engineering*, 7 (4), pp. 352-376.
- Owen, H., 1997, *Open Space Technology: A User's Guide*, Berrett-Koehler.
- Park, R.J., 1998, *Value engineering: a plan for invention*, St-Lucie Press.
- Patil, R., 2006, "Improved techniques for due date quotation in realistic production environments", Ph.D. Thesis, University of Colorado.
- Pattikawa, L.H., Verwaal, E., Commandeur, H.R., 2006, "Understanding new product project performance", *European Journal of Marketing*, 40(11/12), pp. 1178-1193.
- PMI (Project Management Institute), 1996, *A guide to the Project Management Body of Knowledge*, Project Management Institute.
- Rahmandad, H., Weiss, D.M., 2009, "Dynamics of concurrent software development", *System Dynamics Review*, 25(3), pp. 224-249.
- Raz, T., Globerson, S., 1998, "Effective sizing and content definition of work packages", *Project Management Journal*, 29(4), pp. 17-23.
- Rebenstich, W., 2008, "Lean Product Development in the Aerospace Enterprise", *The International Council of the Aeronautical Sciences (ICAS) 2008 Annual Conference*.
- Reinertsen, D., 2007, "Rethinking lean NPD", *Strategic directions*, 23 (10), pp. 32-34.
- Repenning, N.P., Gonçalves. P., Black, L.J., 2001, "Past the Tipping Point: The Persistence of Firefighting in Product Development", *California Management Review*, 43(4), pp. 44-63.
- Réseau des Ingénieurs du Québec. (2007) [online]. [Accessed 8th June 2008]. Available on World Wide Web: <<http://www.reseautiq.qc.ca/en/reseau/dossier.html>> .
- Rother, M., Harris, R., 2001, *Creating continuous flow*, Brookline, Massachusetts: Lean Enterprise Institute.
- Rother, M., Shook, J., 2003, *Learning to see*, Lean Enterprise Institute.
- Rounds, K.S., Cooper, J.S., 2002, "Development of product design requirements using taxonomies of environmental issues", *Research in Engineering Design*, 13, pp. 94-108.
- Sandstrom, J., Toivanen, J., 2002, "The problem of managing product development engineers: can the balanced scorecard be an answer?" *International Journal of Production Economics*, 78, pp. 79-90.
- Semaan, N., 2006, "Subway station diagnosis index (SSDI): a condition assessment model", Master thesis, Concordia university.

- Shenhar, A. Bonen, Z., 1997, "The New Taxonomy of Systems: Toward an Adaptive Systems Engineering Framework", *IEEE Transactions on Systems, Man, and Cybernetics-Part A: Systems and Humans*, 27(2), pp. 137-145.
- Silver, E. A., Pyke, D. F., Peterson, R., 1998, *Inventory Management and Production Planning and Scheduling*, John Wiley & Sons.
- Sipper, D., Bulfin, R., 1997, *Production planning control and integration*, McGraw Hill, 1997.
- Slack, R., 1999, "The lean value principle in military aerospace product development", MIT lean aerospace initiative report series RP99-01-16.
- Smalley, A., 2004, *Creating level pull*. Brookline, Massachusetts, Lean Enterprise Institute.
- Smith, P., 2007, *Flexible product development*, Jossey-Bass.
- Srinivasan, J., Lundqvist, K., 2006, "Why is Aerospace Software Development and Sustainment Hard" [online]. [Accessed 8th June 2008]. Available on World Wide Web:
<http://lean.mit.edu/index.php?option=com_docman&task=doc_details&gid=1745&Itemid=332>.
- Stewart, T.J., Losa, F.B., 2003, "Towards reconciling outranking and value measurement practice", *European Journal of Operational Research*, 145, pp. 645-659.
- Storch, R. L., 1999, "Improving flow to achieve lean manufacturing in shipbuilding", *Production Planning and Control*, 10(2), pp. 127-137.
- Sugimori, Y., Kusunoki, K., Cho, F., Uchikawa, S., 1977, "Toyota production system and Kanban system: materialization of just in time and respect for human system", *International Journal of Production Research*. 15 (6), pp. 553-564.
- Szendrovits, A.Z., 1975, "Manufacturing cycle time determination for a multi-stage economic production quantity model", *Management Science*, 22(3), pp. 298-308.
- Talbi, E., 2009, *Metaheuristics: from design to implementation*, Wiley.
- Taylor, D. H., 2005, "Value Chain Analysis: an approach to supply chain improvements in the agri-food chain", *International Journal of Physical Distribution and Logistics Management*, 35(10), pp. 744-761.
- Ulrich, K.T., Eppinger, S. D., 2004, *Product design and development*, New-York: McGraw Hill.
- Van Koten, C., Gray, A. R., 2005, "Bayesian Statistical Effort Prediction Models for Data Centered 4GL Software Development", Elsevier Science.
- Wallenius, J., Dyer, J.S., Fishburn, P.C., Steuer, R.E., Zionts, R., Deb, K., 2008, "Multiple Criteria Decision Making and Multiattribute Utility Theory", *Management Science* 54(7), pp. 1336-1349.
- Walton, M.A., 1999, "MIT, Strategies for lean product development", Lean Aerospace Initiative.
- Wang, Y., Perkins, J., 2002, "Optimal resource allocation in new product development projects: a control theoretic approach", *IEEE Transactions on Automatic Control*, 47(8), 1267-1276.
- Wirthlin, J.R., 2000, "Best practice in user needs/requirements generation", Lean Aerospace Initiative.

- Womack, J., Jones, D., 2003, *Lean thinking, banish waste and create wealth in your organization*, New-York: Free Press.
- Womack, J., Jones, D.T., Roos, D., 1990, *The machine that changed the world*, Free Press.
- Womack, J., 1996, "The psychology of lean production", *Applied psychology: an international review*. 45(2), pp. 119-152.
- Yoshimura, M., Fujimi, Y., Izui, K. and Nishiwaki, S., 2006, "Decision-making support system for human resource allocation in product development projects", *International Journal of Production Research*, 44(5), pp. 831- 848.
- Zhang, W., 2007, "Production planning in a multi-product environment using constant work in progress", PhD Thesis, Concordia University.

Appendix 1 – Selected Value Stream PD Jobs

Value stream mapping of jobs

The development of engine controls in the aerospace industry is regulated by RTCA DO 178B. This document titled “Software considerations in airborne systems and equipment certification” provides recommendations as to the application of electronics and telecommunications to aeronautical operations.

Certification authorities mandate use of the above mentioned specification, and as a result the development process is generally viewed as consisting of 3 phases: system requirements definition (SRD), software design details (SDD), and validation. Inside these phases a number of rework loops manifest themselves. In many cases the new engine development cycle is itself consisting of 3 cycles, a first engine run, an internal flight test run, and a customer flight test run, with the design of engine controls also evolving along these phases.

Given the certification authorities requirements for traceability of system requirements into detailed design specification and coding, narrow focused jobs are created at each step of the design process. A pre-determined list of job types is suggested, as can be seen with the extract below:

Value stream maps

The focus of this research project on the engine controls development emanates from the realization of the high demand placed on the relatively scarce resources available, or put differently on the higher level of utilization of the engine control design personnel and its relative bottleneck situation.

As a result a 2 days workshop took place in June 2008 with over 30 participants from the controls organization and key suppliers to generate a common vision of the issues and provide specific solutions going forward. The sessions were designed combining Cooperrider's (2008) appreciative inquiry 4D methodology (Discovery, Dream, Design, Destiny) and Owen's Open Space methodology to help organize the front end discovery with such a large group. An extract of the value stream map produced for this event is reproduced below.

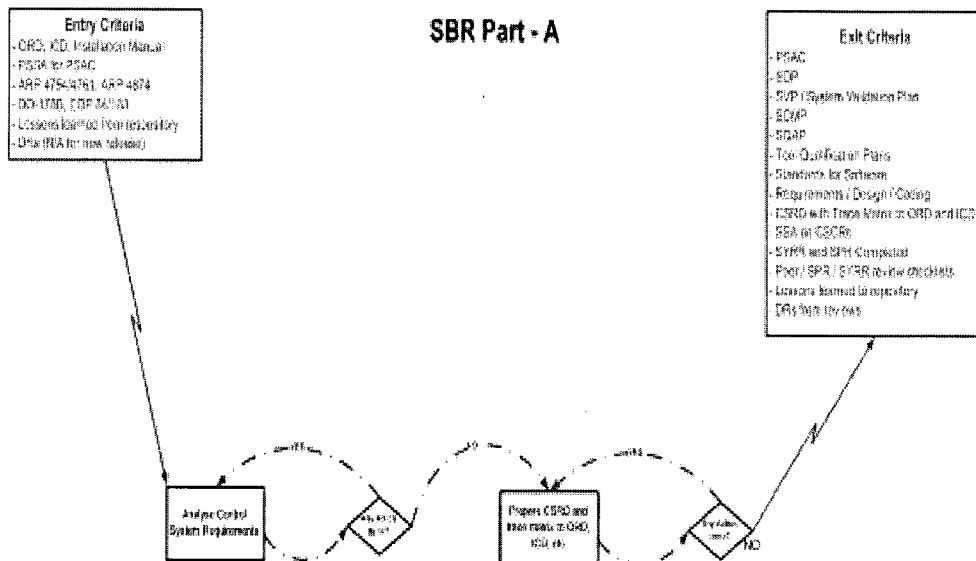

Table 8. System job type classification

Item	System Job description	Includes following tasks
10	Pre-launch program	<ul style="list-style-type: none"> ▪ Proposal support ▪ Technical support ▪ Preparation of presentation meetings ▪ Customer visit
20	Program Launch Planning (Initial Release or Post-Certification)	<ul style="list-style-type: none"> ▪ Level 2 plan ▪ PSAC Plan for software aspect certification ▪ SDP Software development plan ▪ SCMP software configuration management plan ▪ SQAP Software quality assurance plan ▪ SVP Software verification plan ▪ Tool Qualification Plan
21	Program Launch Planning (Delta)	<ul style="list-style-type: none"> ▪ Level 2 plan ▪ Other relevant documents
30	Control System Interface Definition (Initial Release or Post-Certification)	<ul style="list-style-type: none"> ▪ Wiring diagram ▪ SCID ▪ Meeting ▪ ICD
31	Control System Interface Definition (Delta)	<ul style="list-style-type: none"> ▪ Wiring diagram ▪ SCID ▪ meeting ▪ ICD
40	Control System Requirement Definition (Initial Release or Post-Certification)	<ul style="list-style-type: none"> ▪ CSRD ▪ CSCR ▪ Requirement Review ▪ Best Practices ▪ DR's management ▪ Meeting ▪ SBR
41	Control System Requirement Definition (Delta)	<ul style="list-style-type: none"> ▪ CSRD ▪ Requirement Review ▪ Best Practices ▪ CSCR ▪ DR's management ▪ meeting ▪ SBR
50	Interface Requirement Document (Initial Release or Post-Certification)	<ul style="list-style-type: none"> ▪ RCN ▪ DR' Management ▪ meeting
51	Interface Requirement Document (Delta)	<ul style="list-style-type: none"> ▪ RCN ▪ DR' Management ▪ meeting
60	Software Requirement Document (Initial Release or Post-Certification)	<ul style="list-style-type: none"> ▪ SRD ▪ RCN ▪ Traceability ▪ DR' Management ▪ Best Practices ▪ Design Reviews ▪ meeting ▪ SBR
61	Software Requirement Document (Delta)	<ul style="list-style-type: none"> ▪ SRD ▪ RCN ▪ Traceability ▪ Best Practices ▪ Design Reviews ▪ DR' Management ▪ meeting ▪ SBR

70	Software Design Document (Initial Release or Post-Certification)	<ul style="list-style-type: none"> ▪ SDD ▪ Design Reviews ▪ Software Design ▪ meeting ▪ DR' Management
71	Software Design Document (Delta)	<ul style="list-style-type: none"> ▪ SDD ▪ Design Reviews ▪ Software Design ▪ meeting ▪ DR' Management

80	Control System Test Plans (Initial Release or Post-Certification)	<ul style="list-style-type: none"> ▪ Test plans - Flight - Bench & Mingate - Test cell ▪ meeting - FMED
81	Control System Test Plans (Delta)	<ul style="list-style-type: none"> ▪ Test plans - Flight - Bench & Mingate - Test cell ▪ meeting - FMED

90	Engine and Software Testing (Initial Release or Post-Certification)	<ul style="list-style-type: none"> ▪ Test cell support ▪ Bench Support ▪ Data review ▪ Software integration testing ▪ Verification Testing ▪ Validation Testing ▪ RT's ▪ meeting ▪ Flight test support at customer
91	Engine and Software Testing (Delta)	<ul style="list-style-type: none"> ▪ Test cell support ▪ Bench Support ▪ Data review ▪ Software integration testing ▪ Verification Testing ▪ Validation Testing ▪ RT's ▪ meeting ▪ Flight test support at customer

100	Engine Simulation Modeling	<ul style="list-style-type: none"> ▪ EEC Modeling ▪ Engine Modeling ▪ Flight Simulator
-----	----------------------------	---

110	Certification Documents (Initial release)	<ul style="list-style-type: none"> ▪ V&V ▪ VTR ▪ VSR & SVSR ▪ SFI review ▪ meeting ▪ Design Job
111	Certification Documents (Post-Certification)	<ul style="list-style-type: none"> ▪ V&V ▪ VTR ▪ VSR & SVSR ▪ meeting ▪ Design Job ▪ SFI review

140	Customer support inquiries by program families or by customer	▪ Support inquiries by engine families or customer
141	Production Test cell support	▪ Support inquiries by engine families or customer
142	Marketing support	▪ Support inquiries by engine families or customer
144	Methods (ex: Super Doc)	

Then a grouping of the studied value stream jobs has been performed. The resulting Gantt chart is interesting inasmuch it clearly shows the various PD phases. More analysis and discussion are required to determine which of the jobs represent normal iteration versus the extra 'rework', this will likely get done through interviews.

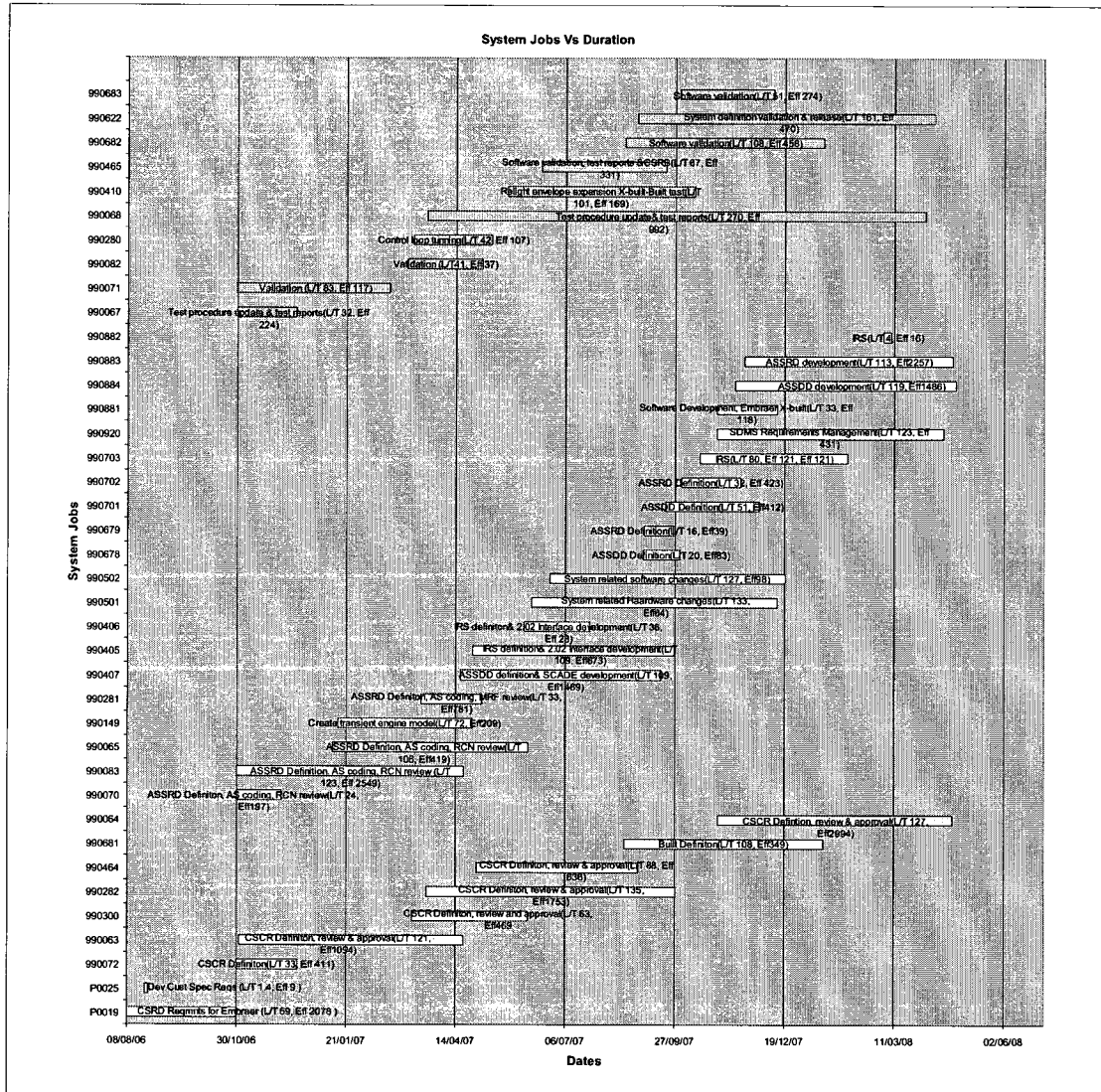

Figure 28. Gantt chart - PD system phases for pre-certification value stream

The above Gantt chart shows the jobs on the y axis and the time is on the x axis. Jobs in the bottom yellow section are considered system level; jobs in the middle blue section are considered software design, while jobs in the top orange category are considered validation jobs, as per the control job types table shown below.

The various iterations referred to earlier can be observed in each of the sections, as the engine definition evolves. In addition extra ‘rework’ is sometimes required to

address specific situations normally occurring in the design of a sophisticated set of engine controls, considering the concurrency between phases in the PD system.

Appendix 2 - Data Acquisition, Descriptive Statistics and Code

Description of data acquired

Relevant product development industrial data has been acquired at the case company. The data consists of daily time card charges from engineering personnel involved in selected product development programs, as follows:

Data acquired and analysis status

Program	Type	Area	Date from	Date to	# Time card charges	Data analysis status	Comments
Product	Pre- cert	Engine controls	2006.09	2008.09	90605	Completed	Most jobs closed
Product2	Pre- cert	Combustor	2005.08	2008.09	734890	Completed	Many jobs still open
Product3	Pre- cert	Engine controls	2006.06	2008.10	417853	Completed	Many jobs still open
Product4	Post- Cert	Cost reduction	TBD	TBD	TBD	Ongoing	Data acquired
Product5	Post- cert	Cost reduction	TBD	TBD	TBD	Ongoing	Data acquired

Data has been acquired from multiple business warehouse (BW) queries to SAP HR time card system using the Business Explorer (SAP BW 3.X) Analyzer (SAP BW 3.X) software in environment PBW 3.5, via query titled “Global report on Actual time for CATS”.

Important fields from the data acquired consist of the following dimensions: employee badge number, date at which a time card charge was made, number of hours charged, job number against which the charge was made. Job descriptions have been used to confirm the job belonging to the area under consideration. Employee names have also been extracted to facilitate interviews.

In order to reduce computation time, negative (correction) charges, as well as 0 hours charges were removed from the data prior to analysis.

The data was acquired in two parts. Initially an exhaustive list of jobs for the selected program and area was selected, and time card charges for the selected jobs obtained through the BW CATS queries into Excel. Following initial analysis revealing which employees were charging to these jobs, a second set of BW CATS queries was ran extracting all charges for these employees for the period under consideration. The following code was used to read the data from Matlab into Excel:

READ_DATA.M

```
function [data datam] = read_data(name, batch, rc,idx)
%
%Created December 1st 2008
%Author: Yvan Beauregard
%read_data read from xls spreadsheet with full path name including
batchxx
%batch is the number of batches to read, up to a maximum of 99
```

```

%data is vertically concatenated into a matrix data, blanks, 0 and
%negative charges are removed in datam. Remove 0 and negative values
from
%supplied data in selected row or column idx, specified as rc=1 for
row,
%rc=2 for column
%
%Initialize
%
data=zeros(1,4);
datam=data;
[m,n] = size(batch);
%
%Get the sheet names
%
%
%Get data into matlab for batches below 9
%
for k=1:batch
    if (k<=9)
        ss=horzcat('batch0',int2str(k));
        data=vertcat(data,xlsread(name,ss,'m:p'));
    end
%
%Get data into matlab for batches above 9
%
    if (k>9)
        ss=horzcat('batch',int2str(k));
        data=vertcat(data,xlsread(name,ss,'m:p'));
    end
end

```

```

        end
    end
    %
    %Get ready to remove zeros and negative charges
    %
    [m n]=size(data);
    %
    % Compression by column
    %
    if(rc==2)
        l=(data(:,idx)>0).*(1:m)'; %find GT0 values at index in master
        s=sum(l>0);
        lm=zeros(1,s);% creates vector of appropriate size to capture index
        i=0;
        for k=1:m
            if(l(k)>0)
                i=i+1;
                lm(1,i)=k;% captures index of GT0 values
            end
        end
    end
    else
        %
        % Compression by row, same as above in another dimension
        %
        if(rc==1)
            l=(data(idx,:)>0).*(1:n);
            s=sum(l>0);
            lm=zeros(1,s);
            i=0;

```

Descriptive statistics of the data acquired from all employees charging on the jobs of interest has been conducted. Due to confidentiality of company data, only summary comments are provided below.

A number of observations can be made of the charged hour descriptive statistics. While over 40% jobs are completed for the Product, only between 1 and 5% are completed for the other projects. This makes the choice of the Product a sound one and a comparison with the other programs more difficult, given the fact that many charges are still coming in for the other projects.

For the Product, there is an average of 3.2 hour charge. Almost 15% of hours charged by employees in the period considered were charged on the Product. For the group of 15 employees that charged over 20% of their hours to the Product, there is an average charge of 5.6 hours observed. The average job size is at 861 hours. About 9% of charges are done on the Product, while the remainder goes to other programs or administrative tasks. The cost overrun estimator for the 29 jobs that have baseline is estimated at 158%. Over 272,000 logistical defects per million opportunities are observed on the jobs, as described in the table above. Finally there is an average of 5 employees working on a Product job, and a touch time ratio of 65%.

The above results have been tabulated from analysis performed using custom built Matlab code. The main reason for using Matlab stemmed from its ability to handle large amount of data with minimum manipulation, and availability of discrete event simulation software within the available toolboxes among others. Below a description of the analysis descriptive statistics code employed, and look at the input and output generated.

Descriptive statistics code

Code has been generated to facilitate generation of descriptive statistics and comparative analysis of the gathered data. One set of code has been applied to generate descriptive statistics by jobs (STAT.M), while the other code has been used to generate descriptive statistics by employees (STAEM).

STAT.M

The STAT.M function is used to produce analysis of the charge patterns by job and overall for the program analyzed. Matrix of charges statistics to jobs is produced, as well as charge size distributions. The latter is obtained by assigning charges to consecutive 5 minutes interval buckets.

```
function [array,nc,adf,bdf] = stat (z)
%
%stat calculates stats for the data inputted.
%column 1 is ee number, column 2 is datevalue, column 3 is actual time,
%column 4 is job number
%
[m,n] = size(z);
[d e f]=unique(z(:,4));
a=size(d);%number of unique jobs
a=2+a(1,1);%+1 given job id 0 is other jobs on which ees worked
array=zeros(a+2,9);%+ 1 given there is a summary last row to be added
array(:,8)=1e10;
%
%getting sum of actual hrs and sum of actual hrs^2, and number of
charges
%m is the job number in the 4th column of z
```

```

%
for k = 1:m
    array(1+z(k,4),1)=array(1+z(k,4),1)+z(k,3);
    array(1+z(k,4),2)=array(1+z(k,4),2)+z(k,3)^2;
    array(1+z(k,4),3)=array(1+z(k,4),3)+1;
    array(1+z(k,4),4)=min(array(1+z(k,4),4),z(k,3));
    array(1+z(k,4),5)=max(array(1+z(k,4),5),z(k,3));
    if(z(k,2)>0)
        array(1+z(k,4),8)=min(array(1+z(k,4),8),z(k,2));
    end
    array(1+z(k,4),9)=max(array(1+z(k,4),9),z(k,2));

end

array(a+2,1)=sum(array(1:a,1));
array(a+2,2)=sum(array(1:a,2));
array(a+2,3)=sum(array(1:a,3));
array(a+2,4)=min(array(1:a,4));
array(a+2,5)=max(array(1:a,5));
array(a+2,8)=min(array(1:a,8));
array(a+2,9)=max(array(1:a,9));

%
%sample mean and standard deviation
%
for k = 1:a+2
    if(array(k,3)>1)
        array(k,6)=array(k,1)/array(k,3);
        array(k,7)=sqrt(array(k,2)-
((array(k,1)^2)/array(k,3))/(array(k,3)-1));
    end
end

```

```

        end

    end

    %
    %Number of 5 min bins in the overall range
    %
    b=(max(z(:,3))-min(z(:,3)))*60/5;
    nc=zeros(a+2,b+1);
    adf=zeros(a+2,b+1);
    bdf=zeros(a+2,b+1);
    %
    %Number of charges by job in each bin
    %
    for k = 1:m
        for l=1:b+1
            if (and(z(k,3)>(l-1)*((array(a+2,5)-
array(a+2,4))/b), z(k,3)<=l*((array(a+2,5)-array(a+2,4))/b)))
                nc(1+z(k,4),l)=nc(1+z(k,4),l)+1;
            end
        end
    end

    end

    %
    %Total number of charges in each bin for all jobs
    %
    for l=1:b+1
        nc(a+2,l)=sum(nc(1:a,l));
    end

    %
    %Probability density function of charged hours in range [min,max]
    %

```

```

for k=1:a+2
    for l=1:b+1
        if(array(k,3)>1)
            adf(k,l)=nc(k,l)/array(k,3);
        end
    end
end

end

%
%Cumulative density function of charged hours in range 1% to 100%
%
bdf(:,1)=adf(:,1);
for k=1:a+2
    for l=2:b+1
        bdf(k,l)=adf(k,l)+bdf(k,l-1);
    end
end

end

%
%Displaying results
%
plot(bdf(1,:));
xlabel('5 minutes time slot #');
ylabel('Probability');
title('CDF individual charged hours - Product Control jobs');
hold on
for k=2:a
    plot(bdf(k,:));
end
hold off

```

Z

Below an extract from the input used for the pre-certification Product engine controls area (Z contains 90605 rows):

Employee reference number	Date charge	Charged hours	Job reference number
65	39350	2	0
65	39351	6	0
65	39352	3	0
65	39353	4.5	0
65	39357	3	0
65	39359	3.5	0
65	39360	5	0
65	39364	2.75	0
65	39366	2	0
34	39345	8.25	37
30	39370	1.75	37
30	39380	1.25	37
30	39382	3.5	37

Column 1 contains the employee reference number, column 2 the date value, column 3 the charged hours, and column 4 the job reference number. Note that job 0 represent all the other jobs

Output from the code provides the following data: array, nc, adf, bdf. Array provides descriptive statistics of charges to jobs. Nc, adf and bdf provide information about the number of charges by job and overall into consecutive 5 minutes buckets, the probability density function by job, and it's associated cumulative distribution function respectively.

ARRAY

Below an extract from the output called array, of size 66 rows (note there are 3 blank rows and 1 reserved for total) by 9 columns. Note that the first row corresponds to all other jobs, while row 2 corresponds to job 990063.

Sum hours	Sum hours^2	Number of charges	Minimum charge	Maximum charge	Average charge	Charge standard deviation	Start date	End date
308469.9	9032635	82550	0	607	3.736765	3005.432	38961	39721
1094.09	6712.006	238	0	9.83	4.597017	81.79721	39022	39192
6703.88	283946.7	732	0	132.5	9.158306	532.7877	39385	39628
431.16	2045.278	101	0	10.5	4.268911	45.0208	39093	39496
16	50	6	0	4	2.666667	6.439462	39615	39681
223.51	1265.334	56	0	9.17	3.99125	35.3428	39020	39065
3960.59	173547.2	316	0	96	12.53351	416.4008	39342	39665
196.99	1618.085	28	0	13	7.035357	39.58226	39020	39054
117	460.5	51	0	8	2.294118	21.33382	39020	39136
411.22	2463.429	92	0	8.75	4.469783	49.42905	39020	39066

NC

Below an extract from the output called nc. Nc represents the number of charges in 5 minutes consecutive time buckets, and has a size of 66 rows by 7284 columns. As per the above table it can be seen that the maximum charge observed on a single charge corresponds to a value of 607 hours (this is a composite charge originating from a supplier accumulating charges from many people). Given there are 12 times 5 minutes time slots in an hour, hence the number of 7284 rows.

0-5 min	5-10 min	10-15 min	15-20 min	20-25 min	25-30 min	30-35 min	35-40 min
48	235	1912	381	1078	9254	172	261
0	0	0	1	0	2	0	0
2	1	3	1	1	5	1	0
0	0	0	0	0	0	0	0
0	0	0	0	0	0	0	0
0	0	0	0	0	0	0	1
0	0	0	0	0	0	0	0
0	0	0	0	0	0	0	0
0	0	2	0	0	2	0	0

ADF

Adf represents the probability density function of charge distribution by job. Again adf size is 66 rows by 7284 columns. Each row represents a job, with row 1 representing the probability density function of charges for all other than the Product jobs. Below an extract from adf:

0-5 min	5-10 min	10-15 min	15-20 min	20-25 min	25-30 min	30-35 min	35-40 min
0.000581	0.002847	0.023162	0.004615	0.013059	0.112102	0.002084	0.003162
0	0	0	0.004202	0	0.008403	0	0
0.002732	0.001366	0.004098	0.001366	0.001366	0.006831	0.001366	0
0	0	0	0	0	0	0	0
0	0	0	0	0	0	0	0
0	0	0	0	0	0	0	0
0	0	0	0	0	0	0	0.003165
0	0	0	0	0	0	0	0
0	0	0	0	0	0	0	0
0	0	0.021739	0	0	0.021739	0	0

BDF

Finally bdf represents the cumulative density function of charges by jobs. Bdf size is 66 rows by 7284 columns. Below an extract from bdf:

0-5 min	5-10 min	10-15 min	15-20 min	20-25 min	25-30 min	30-35 min	35-40 min
0.000581	0.003428	0.02659	0.031205	0.044264	0.156366	0.158449	0.161611
0	0	0	0.004202	0.004202	0.012605	0.012605	0.012605
0.002732	0.004098	0.008197	0.009563	0.010929	0.01776	0.019126	0.019126
0	0	0	0	0	0	0	0
0	0	0	0	0	0	0	0
0	0	0	0	0	0	0	0
0	0	0	0	0	0	0	0.003165
0	0	0	0	0	0	0	0
0	0	0	0	0	0	0	0
0	0	0.021739	0.021739	0.021739	0.043478	0.043478	0.043478

STAE.M

STAE.M is a function used to gather descriptive statistics by employee. Matrix of charges statistics by employees is produced, as well as charge size distributions. The latter is obtained by assigning charges to consecutive 5 minutes interval buckets.

```

function [arrae,ne,nt,ecdadf,ecdbdf,enc,ecsadf,ecsbdf] = stae(z)
%
%Author: Yvan Beauregard
%Date created: 2008-10-13
%
%stat calculates charged hours stats by employee for the data inputted.
%z column 1 is ee number, column 2 is datevalue, column 3 is actual
time,
%column 4 is job number
%
[m,n] = size(z);
[d e f]=unique(z(:,1));
a=size(d);%number of unique employees
a=1+a(1,1);%+1 given job id 0 is other jobs on which ees worked
[d e f]=unique(z(:,4));
b=size(d);%number of unique jobs, will need to add 2 for other jobs and
summary column
arrae=zeros(a+1,7);%+ 1 given there is a summary last row to be added
%
%getting sum of actual hrs and sum of actual hrs^2, and number of
charges
%
% m is the job number in the 4th column of z
%
for k = 1:m
    arrae(z(k,1),1)=arrae(z(k,1),1)+z(k,3);
    arrae(z(k,1),2)=arrae(z(k,1),2)+z(k,3)^2;
    arrae(z(k,1),3)=arrae(z(k,1),3)+1;
    arrae(z(k,1),4)=min(arrae(z(k,1),4),z(k,3));
    arrae(z(k,1),5)=max(arrae(z(k,1),5),z(k,3));

```

```

end
%
%summary for all ees
%
arrae(a+1,1)=sum(arrae(1:a,1));
arrae(a+1,2)=sum(arrae(1:a,2));
arrae(a+1,3)=sum(arrae(1:a,3));
arrae(a+1,4)=min(arrae(1:a,4));
arrae(a+1,5)=max(arrae(1:a,5));
%
%sample mean and standard deviation
%
for k = 1:a+1
    if (arrae(k,3)>1)
        arrae(k,6)=arrae(k,1)/arrae(k,3);
        arrae(k,7)=sqrt(arrae(k,2)-
((arrae(k,1)^2)/arrae(k,3))/(arrae(k,3)-1));
    end
end
%
%Charge distribution of employee by job
%
ne=zeros(a+1,b+2);
nt=zeros(a+1,b+2);
%
%Number of charges (ne) by job by employee (nt in hours)
%
for l=0:b+2
    for i=1:a

```

```

        for k = 1:m
            if (and(z(k,1)==i, z(k,4)==1))
                ne(z(k,1),1+1)=ne(z(k,1),1+1)+1;
                nt(z(k,1),1+1)=nt(z(k,1),1+1)+z(k,3);
            end
        end
    end
end

end

end

%
%Total number of charges in each bin for all jobs
%
for l=1:b+2
    ne(a+1,l)=sum(ne(1:a,l));
    nt(a+1,l)=sum(nt(1:a,l));
end

%
%Probability density function of employee charged hours to job
%
ecdadf=zeros(a+1,b+2);
ecdbdf=zeros(a+1,b+2);
for k=1:a+1
    for l=1:b+2
        if(nt(a+1,l)>0)
            ecdadf(k,l)=nt(k,l)/nt(a+1,l);
        end
    end
end

end

%
%Cumulative density function of employee charged hours to job

```

```

%
ecdbdf(1,:)=ecdadf(1,:);
for k=2:a
    for l=1:b+2
        ecdbdf(k,l)=ecdadf(k,l)+ecdbdf(k-1,l);
    end
end
end
%
%Number of 5 min bins in the overall range
%
b=(max(z(:,3))-min(z(:,3)))*60/5;
enc=zeros(a+1,b+1);
ecsadf=zeros(a+1,b+1);
ecsbdf=zeros(a+1,b+1);
%
%Number of charges by job in each bin
%
for k = 1:m
    for l=1:b+2
        if (and(z(k,3)>(l-1)*((arrae(a+1,5)-
arrae(a+1,4))/b),z(k,3)<=l*((arrae(a+1,5)-arrae(a+1,4))/b)))
            enc(z(k,1),l)=enc(z(k,1),l)+1;
        end
    end
end
end
%
%Total number of charges in each bin for all jobs
%
for l=1:b+1

```

```

        enc(a+1,1)=sum(enc(1:a,1));
end
%
%Probability density function of charged hours in range [min,max]
%
for k=1:a+1
    for l=1:b+1
        if(arrae(k,3)>1)
            ecsadf(k,l)=enc(k,l)/arrae(k,3);
        end
    end
end
end
%
%Cumulative density function of charged hours in range 1% to 100%
%
ecsbdf(:,1)=ecsadf(:,1);
for k=1:a+1
    for l=2:b+1
        ecsbdf(k,l)=ecsadf(k,l)+ecsbdf(k,l-1);
    end
end
end

```

Z

Below an extract from the input used for the pre-certification Product engine controls area (Z contains 90605 rows), this is the same input as for STAT.M:

Employee reference number	Date charge	Charged hours	Job reference number
65	39350	2	0
65	39351	6	0
65	39352	3	0
65	39353	4.5	0
65	39357	3	0
65	39359	3.5	0
65	39360	5	0
65	39364	2.75	0
65	39366	2	0
34	39345	8.25	37
30	39370	1.75	37
30	39380	1.25	37
30	39382	3.5	37

Column 1 contains the employee reference number, column 2 the date value, column 3 the charged hours, and column 4 the job reference number. Note that job 0 represent all the other jobs

Output from the code provides the following data: `arrae`, `ne`, `nt`, `ecdadf`, `ecdbdf`, `enc`, `ecsadf`, `ecsddf`. `Arrae` provides descriptive statistics of charges by employees. `Ne` provides information about the number of charges by employee, `nt` provides information about the sum of hours charged by employee to jobs, `ecdadf` provides the probability density function of employee charged hours to job, `ecdbdf` provides the cumulative density function of density function of employee charged hours to job, `enc` provides the number of charges by job in each bin, `ecsadf` provides the probability density function of charged hours, and finally `ecsddf` provides the cumulative density function of charged hours.

ARRAE

Below an extract from the output called `arrae`, of size 84 rows (note there is one blank rows corresponding to an employee badge repeat) by 7 columns. Note that the last row

represented corresponds to the supplier with a high manpower capacity.

Sum hours	Sum hours^2	Number of charges	Minimum charge	Maximum charge	Average charge	Charge standard deviation
4223	23862.36	1101	0	11	3.835604	154.4268
0	0	0	0	0	0	0
4029.91	24220.52	836	0	10.83	4.820467	155.5547
3521.41	24374.37	665	0	10.34	5.295353	156.033
4777.95	23795.79	1685	0	13.68	2.835579	154.2328
4019.49	28554.11	728	0	13.33	5.521277	168.8893
4032.9	8614.138	3182	0	10	1.26741	92.80372
3969.5	13689.25	2021	0	11.75	1.964127	116.9846
3543.2	11892.4	1722	0	9.8	2.057607	109.0329
2858.5	23765.75	353	0	14	8.097734	153.948
3632.25	15500.69	897	0	7.75	4.049331	124.4358
1906.5	12458.38	356	0	7.75	5.355337	111.4882
3658.3	8159.817	2152	0	8	1.699954	90.3157
88291.99	9396689	2254	0	607	39.17125	3065.152

NE

Below an extract from the output called ne. Ne provides the number of charges by each employee to each job, and has a size of 84 rows by 64 columns. Note that the last 2 columns are blank, as well as the second row. Each row represents an employee, while each column represents a job.

Job1	Job2	Job3	Job4	Job5	Job6	Job7	Job8
562	0	0	0	0	0	0	0
0	0	0	0	0	0	0	0
485	3	0	99	0	14	0	0
649	0	0	0	0	0	0	0
701	64	224	0	3	3	112	0
726	0	0	0	0	0	0	0
3180	0	0	0	0	0	0	0
2015	0	0	0	0	0	0	0
1718	0	0	0	0	0	0	0

NT

Below a sample from nt, which provides information about the sum of hours charged by employee to jobs. Size is 84 rows by 64 columns. Note that the last 2

columns are blank, as well as the second row. Each row represents an employee, while each column represents a job.

Job1	Job2	Job3	Job4	Job5	Job6	Job7	Job8
1250.1	0	0	0	0	0	0	0
0	0	0	0	0	0	0	0
2188.74	12	0	418.66	0	38	0	0
3477.66	0	0	0	0	0	0	0
1061.42	256.55	1026.72	0	10	3.5	512.07	0
4014.74	0	0	0	0	0	0	0
4031.4	0	0	0	0	0	0	0
3945.25	0	0	0	0	0	0	0
3509.7	0	0	0	0	0	0	0
2736.5	0	0	0	0	0	0	0

ECDADF

Below an extract from ecdadf, providing the probability density function of employee charged hours to job. The sum across rows (vertical) corresponds to a value of 1, as each row corresponds to an employee. Again size is 84 rows by 64 columns. Note that this distribution of employees charges to jobs is used in the current simulation scenario.

Job1	Job2	Job3	Job4	Job5	Job6	Job7	Job8
0.004053	0	0	0	0	0	0	0
0	0	0	0	0	0	0	0
0.007095	0.010968	0	0.971008	0	0.170015	0	0
0.011274	0	0	0	0	0	0	0
0.003441	0.234487	0.153153	0	0.625	0.015659	0.129291	0
0.013015	0	0	0	0	0	0	0
0.013069	0	0	0	0	0	0	0
0.01279	0	0	0	0	0	0	0
0.011378	0	0	0	0	0	0	0
0.008871	0	0	0	0	0	0	0

ECDBDF

Below an extract from ecdbdf, providing the cumulative density function of employee charged hours to job.

Job1	Job2	Job3	Job4	Job5	Job6	Job7	Job8
0.004053	0	0	0	0	0	0	0
0.004053	0	0	0	0	0	0	0
0.011148	0.010968	0	0.971008	0	0.170015	0	0
0.022422	0.010968	0	0.971008	0	0.170015	0	0
0.025863	0.245455	0.153153	0.971008	0.625	0.185674	0.129291	0
0.038878	0.245455	0.153153	0.971008	0.625	0.185674	0.129291	0
0.051947	0.245455	0.153153	0.971008	0.625	0.185674	0.129291	0
0.064737	0.245455	0.153153	0.971008	0.625	0.185674	0.129291	0
0.076114	0.245455	0.153153	0.971008	0.625	0.185674	0.129291	0
0.084986	0.245455	0.153153	0.971008	0.625	0.185674	0.129291	0

ENC

Below an extract from enc, providing the number of charges by job in each bin.

Enc size is 84 rows by 7284 columns.

0-5 min	5-10 min	10-15 min	15-20 min	20-25 min	25-30 min	30-35 min	35-40 min
0	0	1	0	2	9	0	1
0	0	0	0	0	0	0	0
0	0	0	0	0	1	0	0
0	0	0	0	0	35	0	0
0	2	3	1	434	30	0	1
0	0	0	0	0	20	0	0
2	7	138	20	20	658	46	24
0	0	20	0	0	56	0	0
0	10	15	11	17	41	0	13
0	0	0	0	0	0	0	0

ECSADF

Below is an extract from ecsadf. It provides the probability density function of charged hours by 5 minutes interval slot. Note that its size is 84 rows by 7284 columns.

0-5 min	5-10 min	10-15 min	15-20 min	20-25 min	25-30 min	30-35 min	35-40 min
0	0	0.000908	0	0.001817	0.008174	0	0.000908
0	0	0	0	0	0	0	0
0	0	0	0	0	0.001196	0	0
0	0	0	0	0	0.052632	0	0
0	0.001187	0.00178	0.000593	0.257567	0.017804	0	0.000593
0	0	0	0	0	0.027473	0	0
0.000629	0.0022	0.043369	0.006285	0.006285	0.206788	0.014456	0.007542
0	0	0.009896	0	0	0.027709	0	0
0	0.005807	0.008711	0.006388	0.009872	0.02381	0	0.007549
0	0	0	0	0	0	0	0

ECSBDF

Finally ecsbdf provides the cumulative density function of charged hours. Again its size is 84 rows by 7284 columns.

0-5 min	5-10 min	10-15 min	15-20 min	20-25 min	25-30 min	30-35 min	35-40 min
0	0	0.000908	0.000908	0.002725	0.010899	0.010899	0.011807
0	0	0	0	0	0	0	0
0	0	0	0	0	0.001196	0.001196	0.001196
0	0	0	0	0	0.052632	0.052632	0.052632
0	0.001187	0.002967	0.003561	0.261128	0.278932	0.278932	0.279525
0	0	0	0	0	0.027473	0.027473	0.027473
0.000629	0.002828	0.046197	0.052483	0.058768	0.265556	0.280013	0.287555
0	0	0.009896	0.009896	0.009896	0.037605	0.037605	0.037605
0	0.005807	0.014518	0.020906	0.030778	0.054588	0.054588	0.062137
0	0	0	0	0	0	0	0

Statistical analysis of charged hours distribution

From the Product engine control data acquired and analyzed previously, a plot of the cumulative probability function of charges hours for the first 200 5 minutes time intervals was produced, as follow:

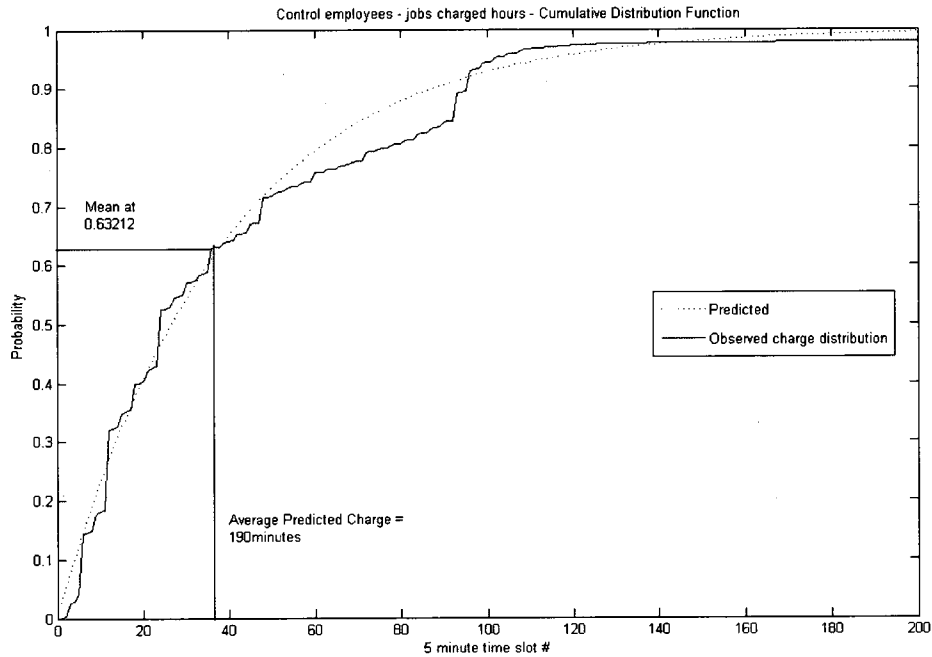

Figure 29. Product observed versus predicted charged hours

The exponential density function is $f(t) = \lambda e^{-\lambda t}$, and the exponential cumulative probability function $F(t) = 1 - e^{-\lambda t}$, both for $t \geq 0$. The mean of the distribution is can be found as $E(x) = \int_0^{\infty} x \lambda e^{-\lambda x} dx = -x e^{-\lambda x} \Big|_0^{\infty} + \int_0^{\infty} e^{-\lambda x} dx = 1/\lambda$. The fraction of charges below the mean $P(T \leq 1/\lambda)$ can be found by integrating the probability density function $f(t)$ as follows $\int_0^{1/\lambda} \lambda e^{-\lambda t} dt = -e^{-\lambda t} \Big|_0^{1/\lambda} = 1 - e^{-1} = .63212$. Thus from the data acquired it can be seen that the average charge is at 38 5 minutes time intervals (or at 190 minutes), with a corresponding parameter $\lambda = \frac{1}{38} = 0.02632$.

The predicted curve in the above figure has been generated using the exponential cumulative distribution function with the parameter λ calculated above. The coefficient

of determination was calculated to judge the adequacy of the exponential regression model to the data obtained. The matlab expression used is reproduced below, it can be seen that over the entire range the regression is adequate with a coefficient of determination of 1.

$$R^2 = 1 - \frac{SSE}{Syy}$$

$$= 1 - \frac{\sum([bdf(64, 1:7284) - (1 - \exp(-0.026315787 * (1:7284)))])^2}{(\sum([1:7284])^2) - (\sum(1:7284)^2)/7284}$$

$$= 1 - 0.260 / 3.2205e+010$$

$$= 1.0$$

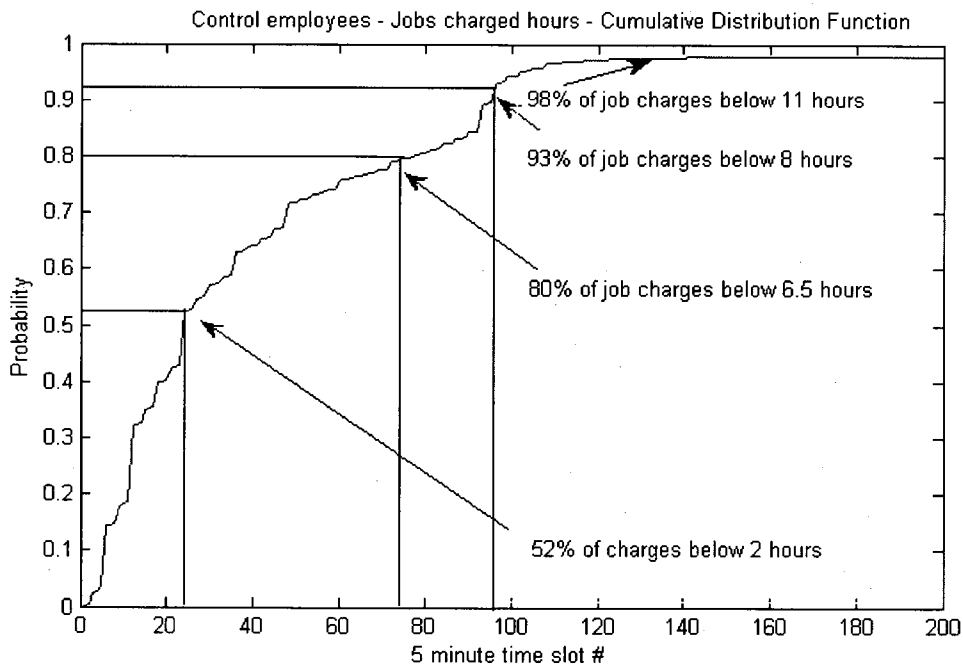

Figure 28. Additional characterization of Product charged hours distribution

The above figure has been generated to provide additional information about the physical meaning of the distribution. It can be noted from this figure that the majority

(52%) of charges are below a 2 hours threshold, that 80% of jobs charges are below 6.5 hours, that 93% of charges to jobs are below 8 hours, and finally that 98% of charges are below 11 hours.

Code developed for analysis of charges by employees

```
function [arrae,ne,nt] = stae(z)
%
%Author: Yvan Beauregard
%Date created: 2008-10-13
%
%stat calculates charged hours stats by employee for the data inputted.
%z column 1 is ee number, column 2 is datevalue, column 3 is actual
time,
%column 4 is job number
%
[m,n] = size(z);
[d e f]=unique(z(:,1));
a=size(d);%number of unique employees
a=1+a(1,1);%+1 given job id 0 is other jobs on which ees worked
[d e f]=unique(z(:,4));
b=size(d);%number of unique jobs, will need to add 2 for other jobs and
summary column
arrae=zeros(a+1,7);%+ 1 given there is a summary last row to be added
%
%getting sum of actual hrs and sum of actual hrs^2, and number of
charges
%m is the job number in the 4th column of z
%
for k = 1:m
```

```

    arrae(z(k,1),1)=arrae(z(k,1),1)+z(k,3);
    arrae(z(k,1),2)=arrae(z(k,1),2)+z(k,3)^2;
    arrae(z(k,1),3)=arrae(z(k,1),3)+1;
    arrae(z(k,1),4)=min(arrae(z(k,1),4),z(k,3));
    arrae(z(k,1),5)=max(arrae(z(k,1),5),z(k,3));
end
%
%summary for all ees
%
arrae(a+1,1)=sum(arrae(1:a,1));
arrae(a+1,2)=sum(arrae(1:a,2));
arrae(a+1,3)=sum(arrae(1:a,3));
arrae(a+1,4)=min(arrae(1:a,4));
arrae(a+1,5)=max(arrae(1:a,5));
%
%sample mean and standard deviation
%
for k = 1:a+1
    if(arrae(k,3)>1)
        arrae(k,6)=arrae(k,1)/arrae(k,3);
        arrae(k,7)=sqrt(arrae(k,2)-
((arrae(k,1)^2)/arrae(k,3))/(arrae(k,3)-1));
    end
end
%
%Charge distribution of employee by job
%
ne=zeros(a+1,b+2);
nt=zeros(a+1,b+2);

```

```

%
%Number of charges by job by employee
%
for l=0:b+1
    for i=1:a
        for k = 1:m
            if (and(z(k,1)==i,z(k,4)==1))
                ne(z(k,1),1+1)=ne(z(k,1),1+1)+1;
                nt(z(k,1),1+1)=nt(z(k,1),1+1)+z(k,3);
            end
        end
    end
end
end
%
%Total number of charges in each bin for all jobs
%
for l=1:b+1
    ne(a+1,l)=sum(ne(1:a,l));
    nt(a+1,l)=sum(nt(1:a,l));
end
%
%Probability density function of charged hours in range [min,max]
%
%for k=1:a+1
%    for l=1:b+1
%        if(array(k,3)>1)
%            adf(k,l)=nc(k,l)/array(k,3);
%        end
%    end
% end

```



```

%end

%
%Cumulative density function of charged hours in range 1% to 100%
%
%bdf(:,1)=adf(:,1);
%for k=1:a+1
%    for l=2:b+1
%        bdf(k,l)=adf(k,l)+bdf(k,l-1);
%    end
%end

%
%Displaying results
%
%plot(bdf(1,:));
%xlabel('5 minutes time slot #');
%ylabel('Probability');
%title('CDF individual charged hours - Product Control jobs');
%hold on
%for k=2:a
%    plot(bdf(k,:));
%end
%hold off

```

Code developed for analysis of charges on jobs

```
function [array,nc,adf,bdf] = stat(z)

%
%stat calculates stats for the data inputted.
%column 1 is ee number, column 2 is datevalue, column 3 is actual time,
%column 4 is job number
%
[m,n] = size(z);
[d e f]=unique(z(:,4));
a=size(d);%number of unique jobs
a=1+a(1,1);%+1 given job id 0 is other jobs on which ees worked
array=zeros(a+1,7);%+ 1 given there is a summary last row to be added
%
%getting sum of actual hrs and sum of actual hrs^2, and number of
charges
%m is the job number in the 4th column of z
%
for k = 1:m
    array(1+z(k,4),1)=array(1+z(k,4),1)+z(k,3);
    array(1+z(k,4),2)=array(1+z(k,4),2)+z(k,3)^2;
    array(1+z(k,4),3)=array(1+z(k,4),3)+1;
    array(1+z(k,4),4)=min(array(1+z(k,4),4),z(k,3));
    array(1+z(k,4),5)=max(array(1+z(k,4),5),z(k,3));
end
array(a+1,1)=sum(array(1:a,1));
array(a+1,2)=sum(array(1:a,2));
array(a+1,3)=sum(array(1:a,3));
array(a+1,4)=min(array(1:a,4));
```

```

array(a+1,5)=max(array(1:a,5));
%
%sample mean and standard deviation
%
for k = 1:a+1
    if(array(k,3)>1)
        array(k,6)=array(k,1)/array(k,3);
        array(k,7)=sqrt(array(k,2)-
((array(k,1)^2)/array(k,3))/(array(k,3)-1));
    end
end
%
%Number of 5 min bins in the overall range
%
b=(max(z(:,3))-min(z(:,3)))*60/5;
nc=zeros(a+1,b+1);
adf=zeros(a+1,b+1);
bdf=zeros(a+1,b+1);
%
%Number of charges by job in each bin
%
for k = 1:m
    for l=1:b+1
        if (and(z(k,3)>(l-1)*((array(a+1,5)-
array(a+1,4))/b), z(k,3)<=l*((array(a+1,5)-array(a+1,4))/b)))
            nc(1+z(k,4),l)=nc(1+z(k,4),l)+1;
        end
    end
end
end
end

```

```

%
%Total number of charges in each bin for all jobs
%
for l=1:b+1
    nc(a+1,l)=sum(nc(1:a,l));
end
%
%Probability density function of charged hours in range [min,max]
%
for k=1:a+1
    for l=1:b+1
        if(array(k,3)>1)
            adf(k,l)=nc(k,l)/array(k,3);
        end
    end
end
end
%
%Cumulative density function of charged hours in range 1% to 100%
%
bdf(:,1)=adf(:,1);
for k=1:a+1
    for l=2:b+1
        bdf(k,l)=adf(k,l)+bdf(k,l-1);
    end
end
end
%
%Displaying results
%
plot(bdf(1,:));

```

```
xlabel('5 minutes time slot #');  
ylabel('Probability');  
title('CDF individual charged hours - Product Control jobs');  
hold on  
for k=2:a  
    plot(bdf(k, :));  
end  
hold off
```

Table 9. Charge statistics by Product control jobs, & non Product jobs (for all employees) in array

SAP job number	Job number	Sum	Sum (Hrs)*2	Number of Charges	Min	Max	Average Charge	Std Dev Charge
non								
contrcls	0	308469.94	9032634.901	82550	0	607	3.736765	3005.432
990064	2	6703.88	283946.7218	732	0	132.5	9.158306	532.7877
990884	45	4879.08	259073.4792	521	0	137.75	9.364837	508.9063
990883	44	4503.35	106489.6243	674	0	96	6.681528	326.269
D7290	57	4433.42	59946.227	654	0	66	6.77893	244.7452
990068	6	3960.59	173547.2033	316	0	96	12.53351	416.4008
991222	52	3899.53	697626.2341	285	0	336	13.68256	835.1278
990083	12	2549.19	18524.1373	428	0	12	5.956051	135.9727
990282	16	2051.76	31399.4642	327	0	87	6.274495	177.0875
P0019	58	1764.79	12422.1005	331	0	14	5.331692	111.3265
990407	23	1631.25	19076.4375	250	0	67	6.525	137.9626
990063	1	1094.09	6712.0055	238	0	9.83	4.597017	81.79721
990860	40	996.36	6661.9484	203	0	12.09	4.908177	81.47232
990683	35	960.18	31679.4706	60	0	72	15.83633	177.2694
991069	48	933.55	5895.3199	196	0	9.16	4.76301	76.63235
990682	34	921.18	20969.1604	120	0	48	7.6765	144.602
991071	50	849.94	5256.5302	198	0	9.25	4.292626	72.3741
990405	21	794.09	6885.9479	154	0	25.5	5.156429	82.88055
990281	15	781	6192.375	127	0	16	6.149606	78.44907
990464	26	654.63	3978.9777	148	0	21	4.423176	62.92281
990681	33	627.46	8019.7654	122	0	24	5.143115	89.40411
990622	30	584.66	7303.0198	127	0	24	4.603622	85.33263
990702	38	546.07	4829.3949	114	0	24	4.790088	69.3271
990701	37	543.5	5389.75	93	0	24	5.844086	73.17941
990465	27	509.63	9712.4713	69	0	59	7.385942	98.27063
990300	17	466.79	2691.3425	109	0	9	4.282477	51.69945
990920	46	458.16	3354.2662	83	0	24	5.52	57.64915
990881	42	431.25	8376.6875	39	0	32	11.05769	90.8361
990065	3	431.16	2045.2784	101	0	10.5	4.268911	45.0208
P0024	60	422.58	15427.464	30	0	48	14.086	123.3783
990072	9	411.22	2463.4294	92	0	8.75	4.469783	49.42905
990861	41	408.49	2062.7607	103	0	8.5	3.965922	45.24244
990322	20	331.04	1732.8018	83	0	12.48	3.988434	41.43308
991241	53	329.23	2751.9691	51	0	24.5	6.45549	52.0525
P0025	61	300.4	1618.9626	97	0	12	3.096907	40.11573
991070	49	298.75	1697.3125	65	0	13	4.596154	40.93724
990321	19	260.17	1365.9295	69	0	10.75	3.77058	36.7628
990502	29	233.26	3562.9466	36	0	24	6.479444	59.3276
990067	5	223.51	1265.3335	56	0	9.17	3.99125	35.3428
990149	13	208.75	1075.3125	50	0	9	4.175	32.51963
990070	7	196.99	1618.0845	28	0	13	7.035357	39.58226
990445	25	191.09	1318.2143	57	0	24	3.352456	36.14934
990410	24	168.96	878.1128	44	0	9.5	3.84	29.37727
990241	62	167	1031	39	0	8.5	4.282051	31.8148
991068	47	152.94	888.3308	33	0	9.5	4.634545	29.43095
990071	8	117	460.5	51	0	8	2.294118	21.33382
991244	54	115	604.875	27	0	8	4.259259	24.20818
990280	14	107.08	473.632	37	0	8.17	2.894054	21.56441
990703	39	98.18	664.4012	18	0	8	5.454444	25.15751
990678	31	90.25	420.5625	27	0	7.75	3.342593	20.22276
990684	36	84	1808	5	0	24	16.8	38.14708
990501	28	63.5	110.41	43	0	3	1.476744	10.40083
990679	32	61.5	709.25	14	0	23	4.392857	26.23868
990882	43	53.25	239.8125	17	0	7.75	3.132353	15.14555
990320	18	37.75	146.0625	11	0	5	3.431818	11.53722
990082	11	37.49	111.2101	17	0	5	2.205294	10.29771
991262	55	34.85	141.3225	11	0	7	3.168182	11.41409
990406	22	23.25	93.9375	11	0	7.75	2.113636	9.435216
990066	4	16	50	6	0	4	2.666667	6.439462
991263	56	14	76	3	0	6	4.666667	6.582806
P0023	59	12	50	4	0	6	3	6.164414
991220	51	3.1	9.61	1	0	3.1	0	0
990081	10	0	0	0	0	0	0	0

Table 9. Statistics for charge Product controls employees over 09-2006 to 09-2008 period) in arrae

ee name	ee badge	ee number	Sum	Sum (Hrs)*2	Number of Charges	Min	Max	Average Charge	Std Dev Charge	Rank	Percentage	Cum Percentage
14	88201.09	9390689	2254	0	0	607	39.17125	3065.152	1	0.243	0.243	
49	4838.9	31314.04	1038	0	0	11	4.661753	176.8963	2	0.013	0.257	
50	4816.75	29927.25	1138	0	0	12	4.232646	172.9431	3	0.013	0.270	
5	4777.85	23795.79	1685	0	0	13.68	2.835579	154.2328	4	0.013	0.283	
30	4513.57	28541.76	984	0	0	16	4.586961	166.8807	5	0.012	0.296	
83	4498	37362.38	664	0	0	18.25	6.774096	193.1746	6	0.012	0.308	
33	4448	15276.75	2027	0	0	12	2.194376	123.5797	7	0.012	0.320	
59	4402.15	30036.77	930	0	0	12	4.733465	173.2465	8	0.012	0.332	
72	4346.85	20708.88	1615	0	0	11.33	2.891548	143.8806	9	0.012	0.344	
51	4332.42	29771.51	877	0	0	18	4.940046	172.4734	10	0.012	0.356	
43	4309.75	26765.31	966	0	0	11.75	4.461439	163.5402	11	0.012	0.368	
39	4298.59	25637.91	1135	0	0	11.4	3.787304	160.0736	12	0.012	0.380	
86	4283.22	30297.88	732	0	0	14.5	5.824071	173.9847	13	0.012	0.392	
87	4237.55	29381.69	829	0	0	13	5.117814	171.276	14	0.012	0.404	
1	4223	23862.36	1101	0	0	11	3.835604	154.4288	15	0.012	0.415	
34	4153.75	26209.81	914	0	0	12.25	4.544694	161.8306	16	0.011	0.427	
60	4151.22	19224.17	1294	0	0	11	3.208053	138.6141	17	0.011	0.438	
68	4127.9	21223.93	1221	0	0	10.67	3.380753	146.6461	18	0.011	0.450	
42	4125.1	28272.4	798	0	0	9.91	5.168298	168.0644	19	0.011	0.461	
48	4088.75	27381.31	814	0	0	16.75	5.036548	166.4265	20	0.011	0.472	
22	4070.25	8973.37	2436	0	0	9.33	1.670874	94.71313	21	0.011	0.483	
7	4032.9	8614.138	3182	0	0	10	1.26741	92.80372	22	0.011	0.495	
3	4029.81	24220.52	836	0	0	10.83	4.820467	155.5547	23	0.011	0.506	
23	4029.75	15860.31	1488	0	0	11	2.708165	125.9086	24	0.011	0.517	
6	4019.49	28554.11	728	0	0	13.33	5.521277	168.8893	25	0.011	0.528	
52	3982.2	27157.77	798	0	0	13.75	4.990226	164.7205	26	0.011	0.539	
28	3975.65	21958.83	1101	0	0	10.58	3.810945	148.1411	27	0.011	0.550	
8	3969.5	13889.25	2021	0	0	11.75	1.964127	116.9846	28	0.011	0.561	
19	3948.84	17953.07	1675	0	0	12.25	2.357516	133.9883	29	0.011	0.572	
55	3948.5	22917.82	945	0	0	10.08	4.178307	151.3286	30	0.011	0.582	
57	3929	14396.5	1497	0	0	14.5	2.824582	119.9567	31	0.011	0.593	
41	3919.84	24340.86	913	0	0	11	4.293363	155.9567	32	0.011	0.604	
32	3883.42	24627.42	859	0	0	16.5	4.520861	156.547	33	0.011	0.615	
64	3845.25	17341.61	1154	0	0	11.6	3.332106	131.6461	34	0.011	0.625	
80	3842.5	8718.875	3273	0	0	9	1.173999	93.35682	35	0.011	0.636	
85	3836.26	23247.19	774	0	0	13	4.956408	152.3896	36	0.011	0.647	
31	3827.33	30033.35	581	0	0	12.42	6.587487	173.1759	37	0.011	0.657	
45	3807.64	21172.02	982	0	0	13	3.877434	145.4543	38	0.010	0.668	
53	3791.5	10461.86	1701	0	0	8.7	2.228983	102.21	39	0.010	0.678	
73	3789.58	29100.68	534	0	0	14.5	7.098592	170.441	40	0.010	0.689	
16	3778.92	16103.01	1227	0	0	10.75	3.078174	126.8803	41	0.010	0.699	
26	3741.3	8582.88	2278	0	0	7.75	1.843805	92.82914	42	0.010	0.709	
63	3725.25	17361.84	1574	0	0	13.75	2.366741	131.7423	43	0.010	0.720	
24	3715.64	10513.66	2578	0	0	9.84	1.441288	102.526	44	0.010	0.730	
15	3710.6	3367.297	5599	0	0	7.75	0.663199	58.02463	45	0.010	0.740	
27	3701.84	19028.17	1346	0	0	8.85	2.750253	137.9152	46	0.010	0.750	
21	3701.08	14695.04	2285	0	0	9	1.619729	120.7991	47	0.010	0.760	
62	3678.35	27376.85	523	0	0	12.98	7.033174	165.3091	48	0.010	0.771	
79	3677.99	13025.93	1512	0	0	10	2.432533	114.1052	49	0.010	0.781	
89	3670.39	23970.61	854	0	0	15.5	4.297881	154.7647	50	0.010	0.791	
47	3663.91	23235.28	740	0	0	10.5	4.891736	152.3526	51	0.010	0.801	
13	3658.3	8159.817	2152	0	0	8	1.899854	90.3157	52	0.010	0.811	
11	3632.25	15500.69	897	0	0	7.75	4.049331	124.4358	53	0.010	0.821	
76	3593.49	25499.03	684	0	0	13	5.25364	159.5976	54	0.010	0.831	
18	3548.6	10844.14	2121	0	0	8	1.873079	103.1569	55	0.010	0.841	
9	3543.2	11892.4	1722	0	0	9.8	2.057607	109.0329	56	0.010	0.851	
74	3529.7	11859.8	1347	0	0	10	2.820416	108.8712	57	0.010	0.860	
4	3521.41	24374.37	665	0	0	10.34	5.295353	156.033	58	0.010	0.870	
46	3338.75	25062.66	490	0	0	10.5	6.813776	158.1649	59	0.009	0.879	
75	3244.78	20435.07	701	0	0	12.42	4.628767	142.8762	60	0.009	0.888	
70	3170.5	20628.38	597	0	0	15.5	5.31072	143.5274	61	0.009	0.897	
37	2987.25	20155.19	538	0	0	11	5.515335	141.8616	62	0.008	0.905	
10	2858.5	23785.75	353	0	0	14	8.097734	153.948	63	0.008	0.913	
81	2730.99	15064.63	541	0	0	8.75	5.048941	122.6352	64	0.008	0.920	
82	2718.75	20978.81	419	0	0	11.5	6.488683	144.6949	65	0.007	0.928	
54	2575.5	20300.75	339	0	0	10.5	7.597345	142.2774	66	0.007	0.935	
78	2583.49	16750.47	585	0	0	9.75	4.53715	129.3439	67	0.007	0.942	
81	2462.58	11313.25	761	0	0	11.75	3.235979	106.3146	68	0.007	0.949	
56	2281.5	11027.25	638	0	0	11.25	3.576019	104.9487	69	0.006	0.955	
77	2081	11759.5	445	0	0	11	4.631461	108.3421	70	0.006	0.961	
12	1906.5	12468.38	356	0	0	7.75	5.355337	111.4882	71	0.006	0.966	
58	1863.17	12082.15	335	0	0	10	5.561701	109.7776	72	0.006	0.971	
40	1549.25	11165.06	285	0	0	15.5	5.435965	105.5244	73	0.004	0.976	
71	1517.4	11620.38	204	0	0	9.08	7.438235	107.5396	74	0.004	0.980	
29	1438	10260.5	256	0	0	10	5.617188	101.1376	75	0.004	0.984	
36	1417.25	10757.94	208	0	0	10.75	6.813702	103.4953	76	0.004	0.988	
25	1231.75	2921.188	916	0	0	8	1.344705	54.03126	77	0.003	0.991	
20	1164.5	7617.625	221	0	0	8.75	5.269231	87.11908	78	0.003	0.994	
35	607	4305	96	0	0	10	6.322917	65.3039	79	0.002	0.996	
17	554.21	1462.581	495	0	0	8	1.142701	38.22659	80	0.002	0.997	
38	505.5	3712.25	74	0	0	9	6.831081	60.53881	81	0.001	0.999	
44	439	1983.93	182	0	0	9.2	2.412088	44.47561	82	0.001	1.000	
2	0	0	0	0	0	0	0	0	83	0.000	1.000	
TOTAL		362693.1	10887578	90805	0	607	4.003014	3298.631				

Table 10. Employee charge distribution to Product control jobs, and 'others' [0906-0908] in nt

ee name	Others	990063	990064	990065	990066	P0025	990241	total w/o others
14	70445.98	0	3246.5	12.5	0	0	0	17846.01
30	723.25	0	0	0	0	31	0	3790.32
5	1061.42	256.55	1026.72	0	10	52.73	0	3716.53
34	1127.75	35.25	0	0	0	60.5	0	3026
1	1250.1	0	0	0	0	0	0	2972.9
28	1550.11	33.08	575.22	0	0	0	0	2425.54
46	1267.65	76.95	275	0	0	0	0	2071.1
3	2188.74	12	0	418.66	0	0	0	1841.17
67	2913.9	0	0	0	0	0	0	1323.65
54	1281	0	0	0	0	0	0	1294.5
29	230.5	0	0	0	0	0	0	1207.5
43	3315.5	0	0	0	0	0	0	994.25
45	2653.47	0	0	0	0	0	0	954.17
31	2961.83	397.69	0	0	0	48.92	0	865.5
40	1080	15.25	0	0	0	0	0	459.25
49	3977.69	0	657.87	0	0	0	0	861.21
33	3639.75	0	0	0	0	48.25	0	808.25
65	3110.02	0	0	0	0	0	0	726.24
47	2975.17	26.16	366.06	0	6	0	0	688.74
62	2991.13	0	0	0	0	0	0	687.22
50	4150.25	0	459.5	0	0	0	0	666.5
70	2641.5	0	0	0	0	0	0	529
61	1996.75	0	0	0	0	0	0	465.83
48	3673.25	76.5	0	0	0	0	0	426.5
32	3527.32	28.92	0	0	0	49	0	356.1
39	4012.24	0	0	0	0	0	0	286.35
60	3670.47	0	0	0	0	0	0	280.75
56	2072.75	0	0	0	0	0	0	208.75
66	4064.37	0	0	0	0	0	0	198.85
42	3934.59	91.59	0	0	0	10	0	190.51
75	3078.53	0	0	0	0	0	0	166.25
55	3620.32	0	0	0	0	0	0	128.18
11	3508.5	0	0	0	0	0	0	123.75
10	2736.5	0	0	0	0	0	0	122
12	1786.25	0	0	0	0	0	0	120.25
58	1740.17	0	0	0	0	0	114	114
41	3606.15	44.25	0	0	0	0	0	113.69
36	1312.5	0	0	0	0	0	0	104.75
74	3428.7	0	0	0	0	0	0	101
35	527	0	0	0	0	0	0	80
71	1440.07	0	0	0	0	0	0	77.33
68	4058.9	0	0	0	0	0	0	69
83	4434	0	0	0	0	0	0	64
73	3728.33	0	0	0	0	0	0	61.25
72	4285.93	0	0	0	0	0	0	60.92
52	3921.53	0	60.67	0	0	0	0	60.87
57	3876	0	0	0	0	0	53	53
69	3617.47	0	0	0	0	0	0	52.92
82	2674	0	0	0	0	0	0	44.75
4	3477.66	0	0	0	0	0	0	43.75
51	4296.08	0	36.34	0	0	0	0	36.34
9	3509.7	0	0	0	0	0	0	33.5
78	2534.16	0	0	0	0	0	0	29.33
8	3946.25	0	0	0	0	0	0	24.25
77	2037	0	0	0	0	0	0	24
81	2713.99	0	0	0	0	0	0	17
59	4386.15	0	0	0	0	0	0	16
37	2954.25	0	0	0	0	0	0	13
53	3780.9	0	0	0	0	0	0	10.6
64	3636.85	0	0	0	0	0	0	8.4
79	3670.24	0	0	0	0	0	0	7.75
19	3941.17	0	0	0	0	0	0	7.67
16	3789.42	0	0	0	0	0	0	7.5
44	432	0	0	0	0	0	0	7
22	4064.17	0	0	0	0	0	0	6.08
13	3662.3	0	0	0	0	0	0	6
24	3709.82	0	0	0	0	0	0	5.82
15	3705.52	0	0	0	0	0	0	5.08
6	4014.74	0	0	0	0	0	0	4.75
38	501.5	0	0	0	0	0	0	4
23	4025.75	0	0	0	0	0	0	4
63	3722.75	0	0	0	0	0	0	2.5
25	1229.75	0	0	0	0	0	0	2
27	3699.84	0	0	0	0	0	0	2
20	1183	0	0	0	0	0	0	1.5
7	4031.4	0	0	0	0	0	0	1.5
26	3740.15	0	0	0	0	0	0	1.15
76	3592.49	0	0	0	0	0	0	1
21	3700.08	0	0	0	0	0	0	1
80	3641.5	0	0	0	0	0	0	1
17	553.71	0	0	0	0	0	0	0.5
18	3548.35	0	0	0	0	0	0	0.25
2	0	0	0	0	0	0	0	0
Total	308469.9	1094.09	6703.88	431.16	16	300.4	167	54223.12

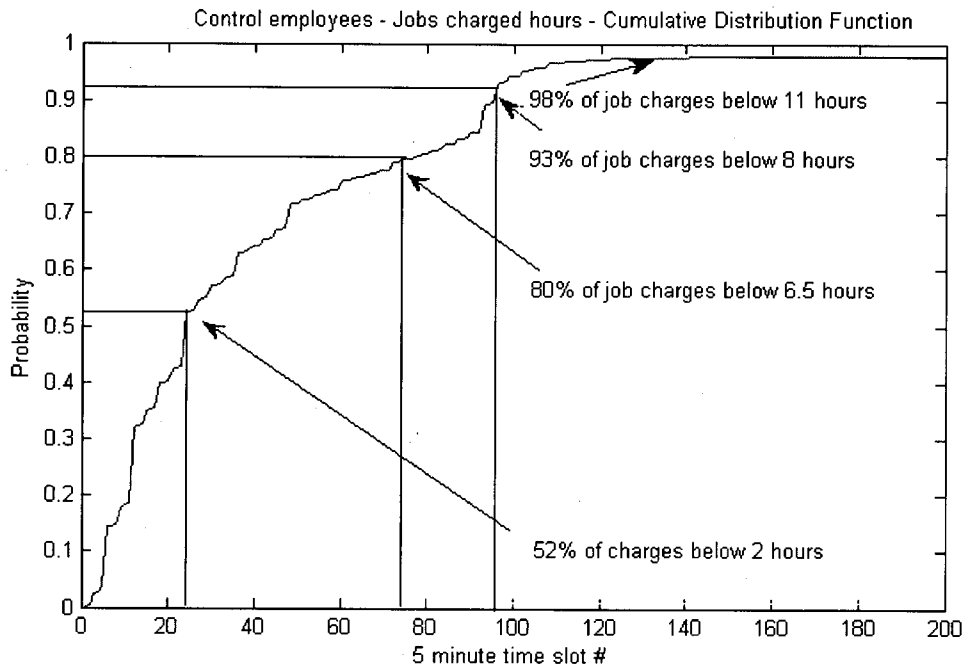

Figure 29. All jobs charged hours distribution - plot

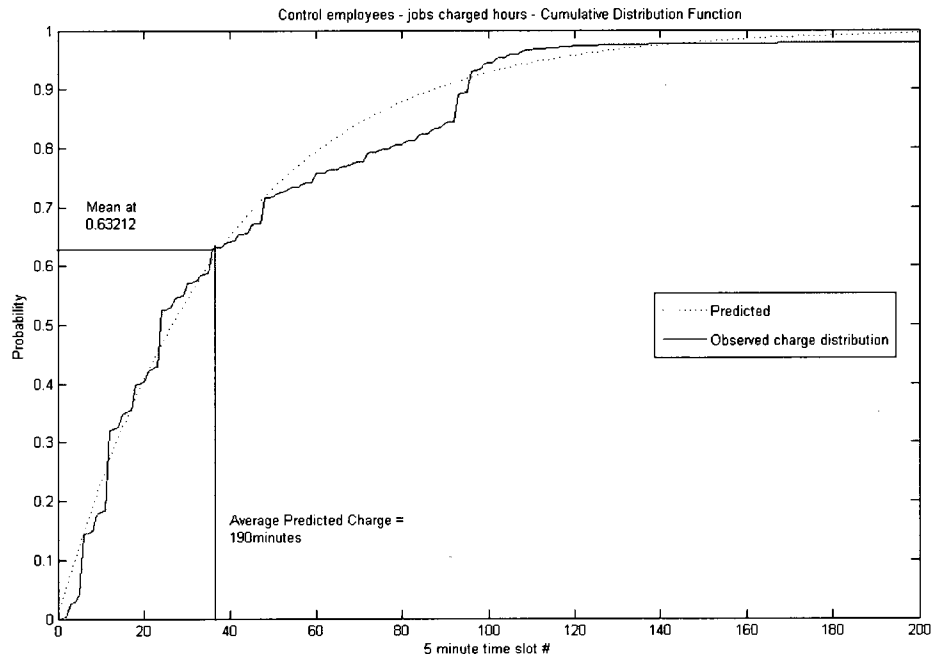

Figure 30. All jobs charged hours distribution - with predicted exponential cdf

Coefficient of determination R2 calculated as follows:

$$R^2 = 1 - \text{SSe} / \text{Syy}$$

$$= 1 - \frac{\sum([(\text{bdf}(64, 1:7284) - (1 - \exp(-0.026315787 * (1:7284))))]^2)}{(\sum([1:7284].^2) -$$

$$(\sum(1:7284)^2) / 7284)$$

$$= 1 - 0.260 / 3.2205e+010$$

$$= 1.0$$

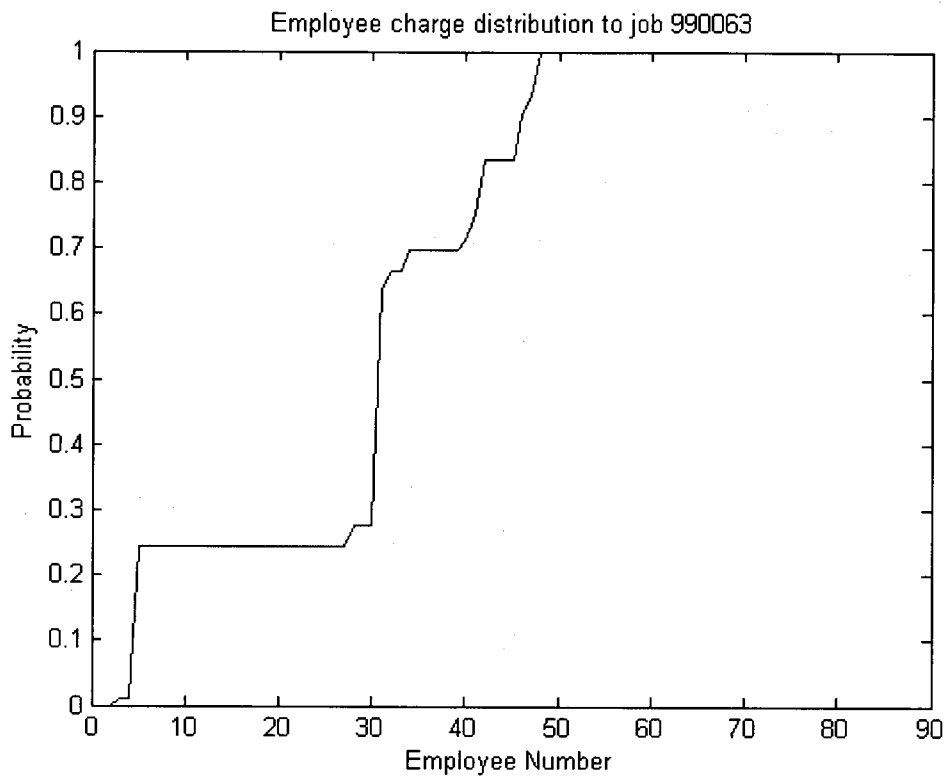

Figure 31. Job charge size distribution by employee

Job charge size distribution by employee [size, job precedence, % concurrence, cdf ee charging] for a given job in ecdbf. To preserve confidentiality of employee related time card data analysis, tables of cumulative charge distribution by job, number of charges per employees per five minutes time slots, and probability distribution function and cumulative distribution function of the number of charges per employees per five minutes time slots have been removed from this thesis. Note however that these items were used as input into the discrete event simulation model described in Appendix 4.

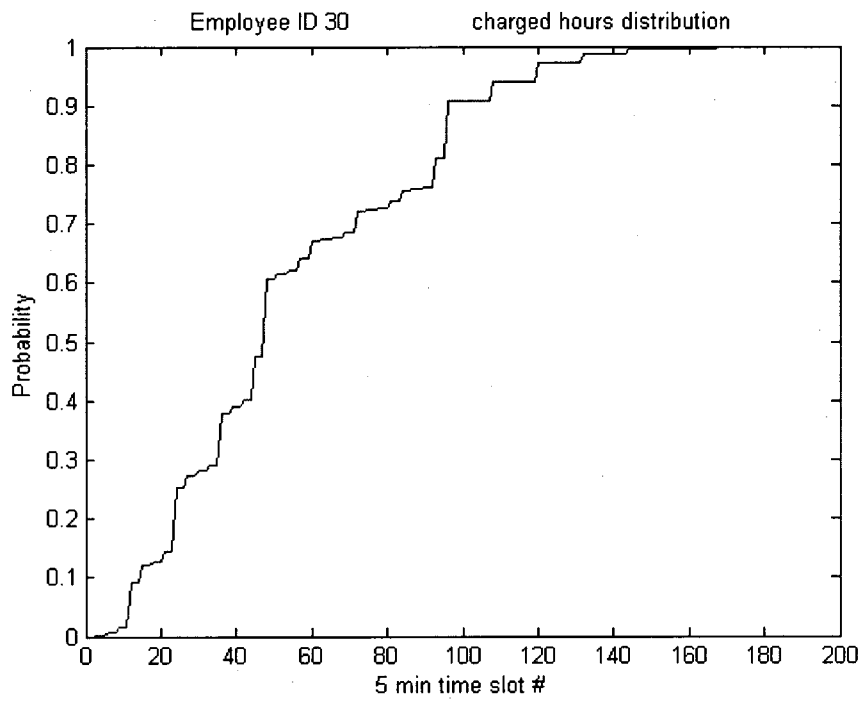

Figure 32. Charge hours distribution by employee

Appendix 3 – Economic Design Quantity (EDQ) model code

The reader will find enclosed below code for the displaying of the TRC and Q as a function of c and f. In addition the code enables consideration of schedule and budget maximum variations from best case.

PDEOQ provides the optimal design job size for various combinations of concurrency and focus, for given setup, demand, unit cost, carrying cost, number of phase, % from optimal budget and schedule, and given waste.

```
function [q c f trc btrc ttrc otrc]=pdeoq (a,d,v,r,n,b,w)
%
% Calculates the optimal job size for various combinations of
% concurrency c and focus f,
% for given setup cost a, period demand d, value of unit v, and
% carrying
% cost r, and highlights points within b % variation to schedule (c=1,
% f=1) and budget (c=0, f=1).
% w is the waste [0,1] for 100% concurrency.
% (s'assurer de verifier les unites)
%
trc=zeros(100,100);
btrc=zeros(100,100);
ttrc=zeros(100,100);
otrc=zeros(100,100);
q=zeros(100,100);
qb=zeros(100,100);
qt=zeros(100,100);
```

```

qo=zeros(100,100);
f=zeros(100,1);
c=zeros(100,1);
for i=1:100
    f(i,1)=0.01*i;
    for j=1:100
        c(j,1)=0.01*j;
        q(i,j)=((2*a*d)/((v*r)*(((1/n)-1)*c(j,1)+1)*((2/f(i,1))-
1))))^0.5;
        trc(i,j)=((a*d)/q(i,j))+(0.5*q(i,j)*v*r*(((1/n)-
1)*c(j,1)+1))+(q(i,j)*((v*r)*(((1/n)-1)*c(j,1)+1)*((1/f(i,1))-
1)))+(v*d*w*c(j,1));
    end
end
for i=1:100
    for j=1:100
        if(b>=abs(100*(trc(i,j)-trc(100,1))/trc(100,1)))
            btrc(i,j)=trc(i,j);
            qb(i,j)=q(i,j);
        end
        if((b/n)>=((((1/n)-1)*c(j,1)+1)*((1/f(i,1))-1)))
            ttrc(i,j)=trc(i,j);
            qt(i,j)=q(i,j);
        end
        if(btrc(i,j)>0)
            if(ttrc(i,j)>0)
                otrc(i,j)=trc(i,j);
                qo(i,j)=q(i,j);
            end
        end
    end
end

```

```

        end
    end
end

[x y]=meshgrid(f,c);
subplot(3,2,1); surf(x',y',trc)
xlabel('Focus')
ylabel('Concurrency')
zlabel('TRC ($)')
title('Total Relevant Cost (TRC) Example d=50000, a=700, v=100,
r=.1075, n=3')
% text(1,-1/3,'{Note the odd symmetry.}')
subplot(3,2,2); surf(x',y',btrc)
xlabel('Focus')
ylabel('Concurrency')
zlabel('TRC ($)')
title('TRC within b=25% of Optimal Budget Value (c=0, f=1)')
subplot(3,2,3); surf(x',y',ttrc)
xlabel('Focus')
ylabel('Concurrency')
zlabel('TRC ($)')
title('TRC within b=25% of Optimal Schedule (1/n, c=1, f=1)')
subplot(3,2,4); surf(x',y',otrc)
xlabel('Focus')
ylabel('Concurrency')
zlabel('TRC ($)')
title('TRC within b=25% of Optimal Schedule and Budget Values')
subplot(3,2,5); surf(x',y',q)
xlabel('Focus')
ylabel('Concurrency')

```

```

zlabel('Job Size (Hrs)')
title('Economic Design Quantity (EDQ) Example d=50000, a=700, v=100,
r=.1075, n=3')
subplot(3,2,6); surf(x',y',qo)
xlabel('Focus')
ylabel('Concurrency')
zlabel('Job Size (Hrs)')
title(' EDQ within b=25% of Optimal Schedule and Budget Values')

```

edq_plot provides the visual representation of the various components of the total relevant cost for an actual versus an optimal configuration of concurrency c and focus f

```

function [oo oa w hwa hwo hdo hda trcqo trcqa] =edq_plot (d,a,r,v,n,w)
%
% Plot various components of EDQ for case company current case, and
% optimal case
%
trcqa=zeros(300,1);
oa=zeros(300,1);
wa=zeros(300,1);
hwa=zeros(300,1);
hda=zeros(300,1);
qa=zeros(300,1);
fa=.1;
ca=.7;
trcqo=zeros(300,1);
oo=zeros(300,1);
wo=zeros(300,1);

```



```

hwo=zeros(300,1);
hdo=zeros(300,1);
qo=zeros(300,1);
fo=.9;
co=.1;
i=0;
for i=1:300
    qa(i)=i*50;
    oa(i)=(a*d)/qa(i);
    wa(i)=(v*d*w*ca);
    hwa(i)=(qa(i)*((v*r)*(((1/n)-1)*ca+1)*((1/fa)-1)));
    hda(i)=(0.5*qa(i)*v*r*(((1/n)-1)*ca+1));
    trcqa(i)=((a*d)/qa(i))+(0.5*qa(i)*v*r*(((1/n)-
1)*ca+1))+qa(i)*((v*r)*(((1/n)-1)*ca+1)*((1/fa)-1))+v*d*w*ca);
    qo(i)=i*50;
    oo(i)=(a*d)/qo(i);
    wo(i)=(v*d*w*co);
    hwo(i)=(qo(i)*((v*r)*(((1/n)-1)*co+1)*((1/fo)-1)));
    hdo(i)=(0.5*qo(i)*v*r*(((1/n)-1)*co+1));
    trcqo(i)=((a*d)/qo(i))+(0.5*qo(i)*v*r*(((1/n)-
1)*co+1))+qo(i)*((v*r)*(((1/n)-1)*co+1)*((1/fo)-1))+v*d*w*co);
end
subplot(2,1,1); plot(qa,trcqa,'-.k')
set(gca,'XTick',0:1000:15000)
xlabel('EDQ (Hrs)')
ylabel('TRC ($)')
title('Economic Design Quantity (EDQ) Example d=50000, a=700, v=100,
r=.1075, n=3,w=.05, f=.1, c=.7')
hold on

```

```

plot(qa, wa, '-.r')
plot(qa, oa, '-.b')
plot(qa, hwa, '-.m')
plot(qa, hda, '-.g')
h = legend('Total Relevant Cost', 'Waste', 'Ordering', 'Carrying
Waiting', 'Carrying Design', 5);
set(h, 'Interpreter', 'none')
hold off
subplot(2,1,2); plot(qo, trcqo)
set(gca, 'XTick', 0:1000:15000)
xlabel('EDQ (Hrs)')
ylabel('TRC ($)')
title('Economic Design Quantity (EDQ) Example d=50000, a=700, v=100,
r=.1075, n=3, w=.05, f=.9, c=.1')
hold on
plot(qo, wo, '-.r')
plot(qo, oo, '-.b')
plot(qo, hwo, '-.m')
plot(qo, hdo, '-.g')
h = legend('Total Relevant Cost', 'Waste', 'Ordering', 'Carrying
Waiting', 'Carrying Design', 5);
set(h, 'Interpreter', 'none')
hold off

```

Appendix 4 – Discrete Event Simulation Code and Results

High level description of discrete event model

Random charge generator

Function below has been developed to generate the appropriate random charges as per defined distribution.

```
function [x] = random_chg_hr(v)
%
% Generate random simulation data for the DES.
% u is the intergeneration time for the entity, v is the total charged
hours not to exceed
% Vector of total charges read from tchg_hr variable in workspace.
%
h=0;
i=0;
li=0;
while(i<v)
    h=h+1;
    li=exprnd(5*38/60);
    i=li+i;
    y(h,2)=li;
    y(h,1)=h;
end
if v<i
    y(h,2)=max(0,v-sum(y(1:h-1,2)));
end
x.time = ([y(:,1)]);
```

```
x.signals(1).values = ([y(:,2)]);
x.signals(1).dimensions = 1;
```

Discrete event simulation model

Below is the model with the initial block limits. It used job 990063, 990300, and other charges for the remainder of the 85%+ of charges in the system. Five employees representing over 80% of charges are there to work the jobs. Employee 6 represents the other employees that are not in the model due to block restrictions.

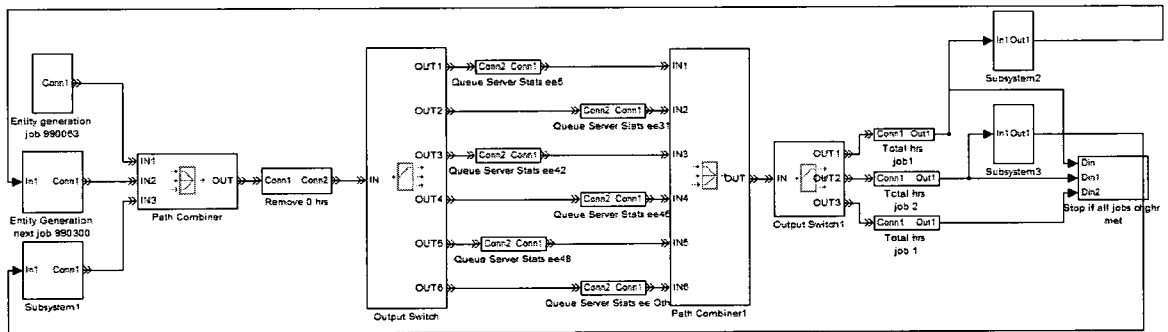

Figure 33. DES simple three jobs and five employees model

Below is the content of subsystem entity generation job 990063, all entity generation subsystems are similar.

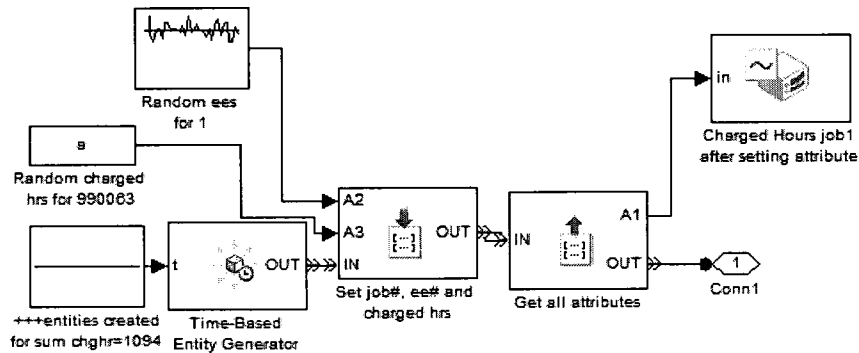

Figure 36. Content of subsystem entity generation job 990063

Below is the content of subsystem entity generation job 990300. The subsystem for other jobs is similar to this one.

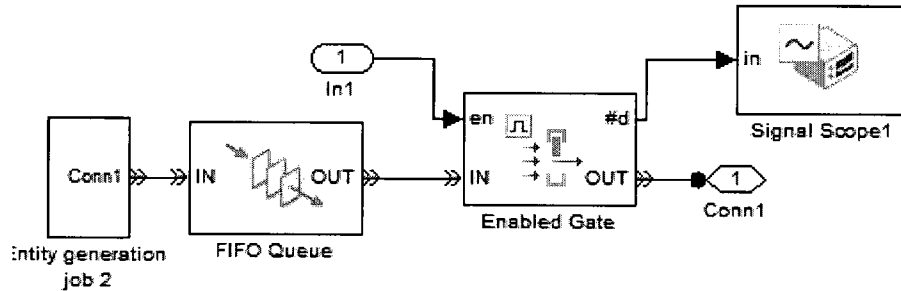

Figure 37. Content of subsystem entity generation job 990300

The entity generation block for job 2 is similar to that of block 1, albeit an infinite capacity FIFO queue is required to hold entities generated as the start of the simulation until sufficient progress has been made on the predecessor job to start the subsequent one. There is a need to remove jobs generated with 0 charged hrs, as follows:

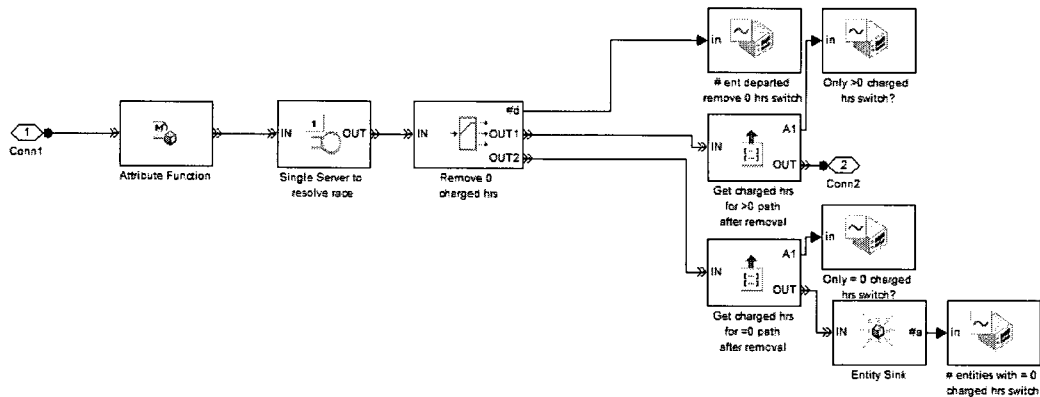

Figure 38. Subsystem to remove 0 hrs entities

Next the jobs are dispatched to the appropriate queue server combination according to the employee number attribute. The subsystem allows for the capture of relevant charged hours metrics into the workspace variables. Similar arrangements for the other queue server combinations exist.

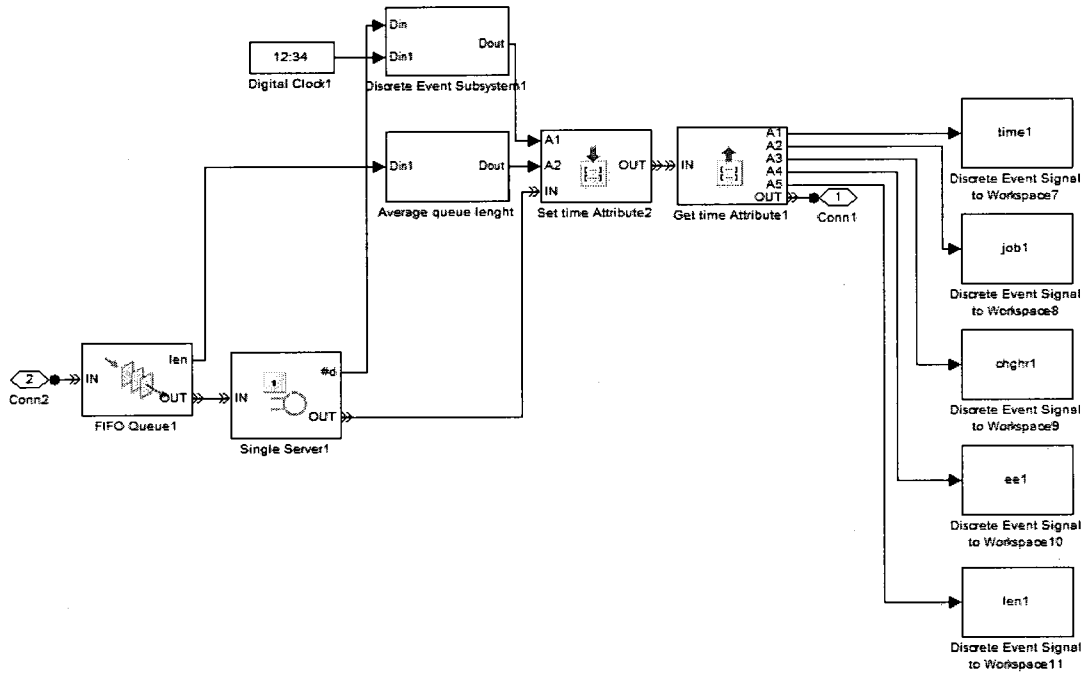

Figure 39. Job dispatch to queue/server

Then completed charged hours are dispatched back to their respective jobs using the job number attribute.

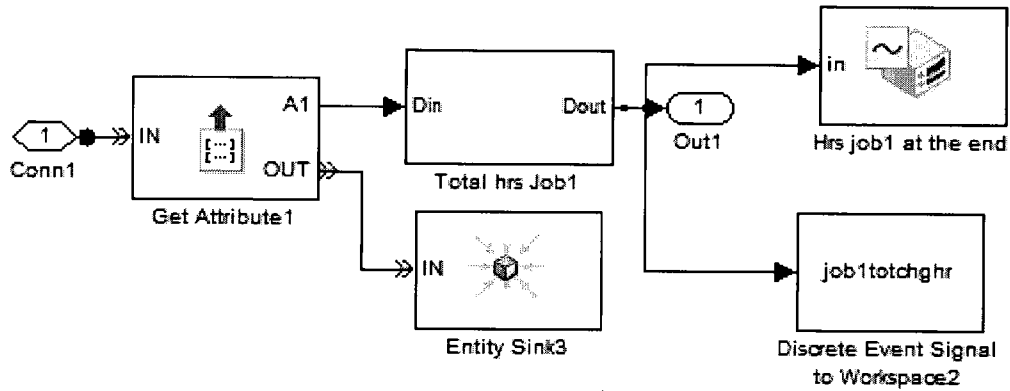

Figure 34. Capture of job statistics

The total hours calculation is done using an embedded matlab function as follows:

```
function y = totalhrs(u)
% Compute the total charged hrs for signal U.
%
% Declare variables that must retain value between iterations
%
persistent lhr hr;
%
% Initialize persistent variables in the first iteration
%
if isempty(hr)
    hr=0;
    lhr=0;
end
%
% Update persistent variables
%
lhr=u;
hr=hr+lhr;
```

y=hr;

Next a signal to determine whether the following job can start is generated, using workspace variable shr1. A similar arrangement exists for the job number 3, although the shr2 value is set at 0. Shr1 value is calculated for job1 as the total charged hours multiplied by the ratio of job1 lead time executed without job2 presence over job1 total lead time.

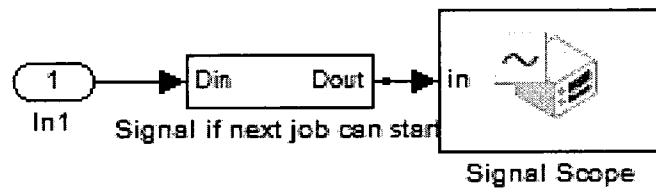

Figure 35. Concurrency control logic

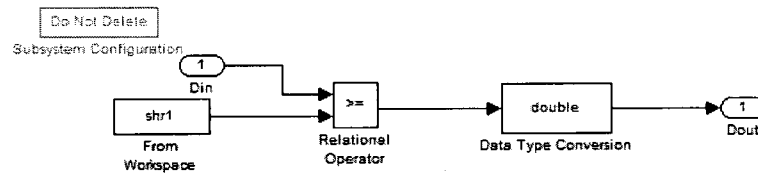

Figure 36. Simulation start conditions

Finally the simulation stopping conditions are verified, using workspace variable thr1, thr2, thr3:

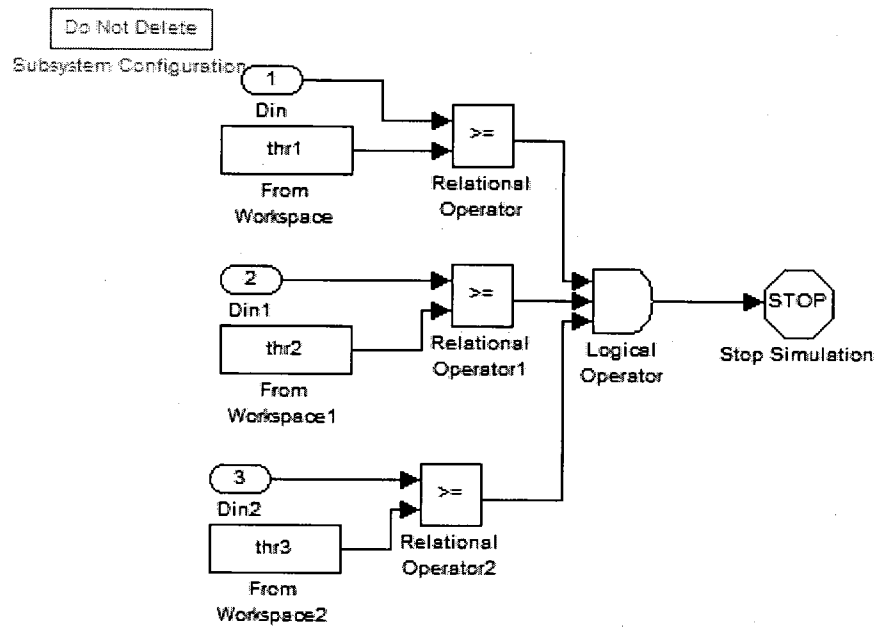

Figure 37. Simulation stop conditions

Product engine control model

The Product simulation model is shown in a preliminary fashion below. Constraints on the number of blocks available under the student version prohibit for now the complete design of this model, until professional version becomes available.

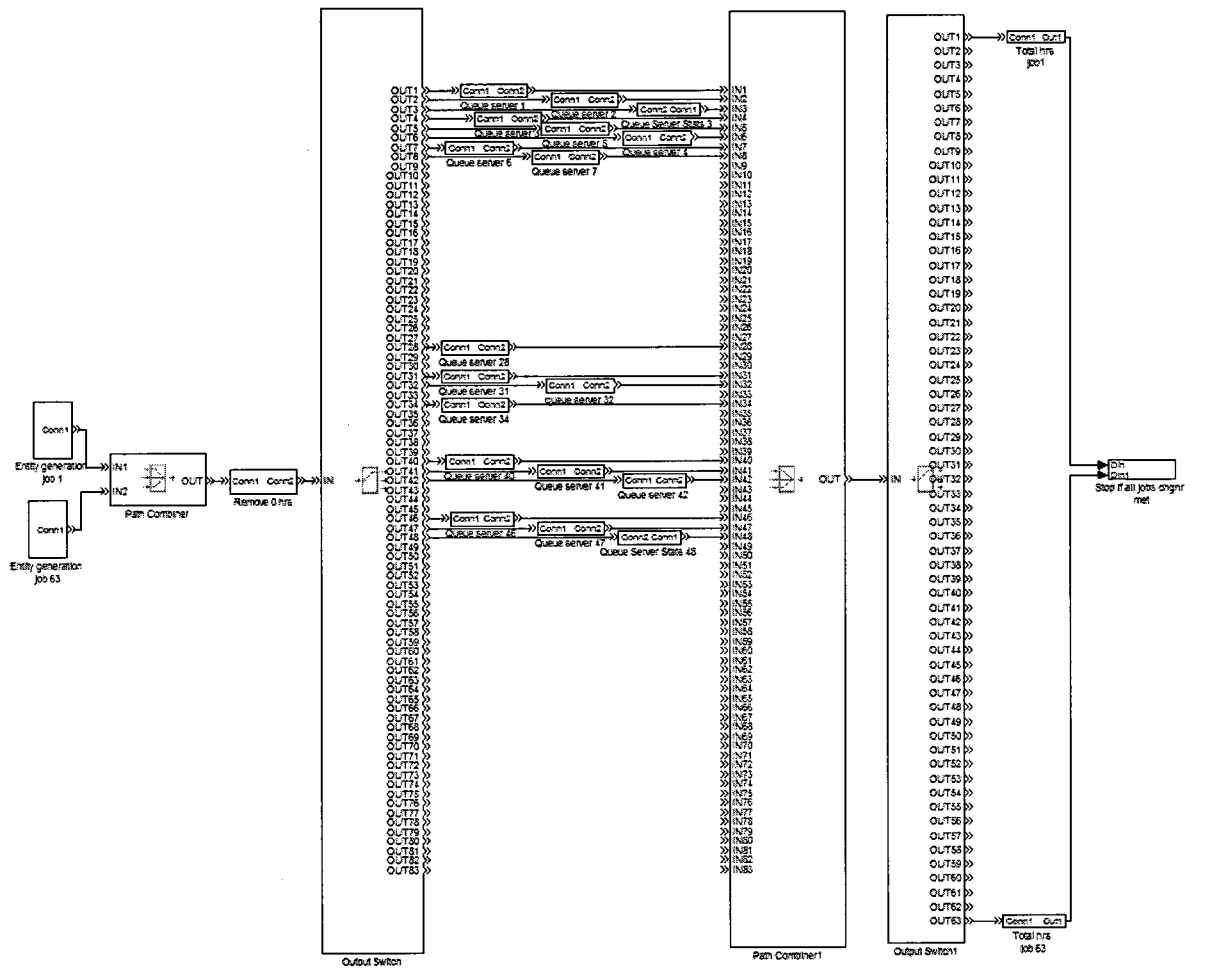

Figure 38. High level product simulation model

Performance measurement simulation

Given that new engine development cycle is typically completed over multiple years, a need to experiment with different product development and design policies and select best arrangement is required.

Lean metrics & baseline

The following code is used to generate the lean metrics for the baseline convened as the variable Z containing the 90605 actual charges captured in the SAP CATS B/W Analyzer system.

LEAN_METRIC_BASELINE.M

```
function [xd z array] = lean_metric_baseline(z)
%
% Generate lean engineering metrics
% Input data is formed by the prior vertcat of relevant simulation data
% from workspace.
% Columns are ee#, time, charged hours, job # and average queue length
% Output data corresponds to mxn matrix of m jobs by n lean metrics
% Column 1 to 10 of data are start date, end date, duration, working
days, charged
% hours, touch days, non touch days, touch hours, non touch hours,
restarts, number of nodes
%
% Use zm as input, rearrange job# index
%
l=63;
while(l>=1)
    l=l-1;
    for k=1:90605
        if (z(k,4)==1)
            z(k,4)=l+1;
        end
    end
end
end
```

```

[m,n] = size(z);
[d e f]=unique(z(:,4));
a=1+size(d);%number of unique jobs + 1 given data provided
array=zeros(a+1,11);
array(:,1)=1e10;%to get minimum
%
% Start date, end date, duration, working days, charged hours
%
for k = 1:m
    array(z(k,4),1)=min(array(z(k,4),1),z(k,2));
    array(z(k,4),2)=max(array(z(k,4),2),z(k,2));
    array(z(k,4),4)=(array(z(k,4),2)-array(z(k,4),1));
    array(z(k,4),3)=array(z(k,4),4)*1.4;
    array(z(k,4),5)=array(z(k,4),5)+z(k,3);
end
%
%Number of nodes
%
for l=1:a
    [i j]=size(unique(z(z(:,4)==l,1)));
    array(l,11)=i;
end
%
% Charged days
%
%cd=zeros(a,ceil(max(z(:,2))/7.75));
cd=zeros(a,max(z(:,2))-min(z(:,2)));
tdnc=cd;
tdsc=cd;

```

```

td=cd;

ntd=cd;

ntdsc=cd;

rst=cd;

[i j]=size(cd);

n=min(z(:,2));

for k = 1:m

    for l=1:j+1

        if (and(z(k,2)>1-1+n, z(k,2)<=1+n))

            cd(z(k,4),l)=cd(z(k,4),l)+1;

        end

    end

end

end

%

% Number of charges >2hrs by touch days (tdnc)

%

for k = 1:m

    for l=1:j+1

        if (and(z(k,2)>((1-1)+n), z(k,2)<=1+n))

            if (z(k,3)>=2)

                tdnc(z(k,4),l)=tdnc(z(k,4),l)+1;

            end

        end

    end

end

end

%

% Sum of charges >=2hrs by touch days (tdsc)

%

for k = 1:m

```

```

for l=1:j+1
    if (and(z(k,2)>((l-1)+n), z(k,2)<=l+n))
        if(z(k,3)>=2)
            tdsc(z(k,4),l)=tdsc(z(k,4),l)+z(k,3);
        end
    end
end
end
end
end
end
%
% Sum of charges <2hrs by touch days (ntdsc)
%
for k = 1:m
    for l=1:j+1
        if (and(z(k,2)>((l-1)+n), z(k,2)<=l+n))
            if(z(k,3)<2)
                ntdsc(z(k,4),l)=ntdsc(z(k,4),l)+z(k,3);
            end
        end
    end
end
end
end
end
%
% Touch day (td)
%
for k=1:i
    for l=1:j
        if(tdnc(k,l)>=1)
            td(k,l)=1;
        end
    end
end
end

```

```

end
%
% Restarts
%
for k=1:i
    for l=1:j
        if(td(k,l)==1)
            o=l+11;
            if((j-o)>0)
                for p=l+1:o
                    rst(k,l)=rst(k,l)+td(k,p);
                end
                if (rst(k,l)>0)
                    rst(k,l)=0;
                else
                    rst(k,l)=1;
                end
            end
        end
    end
end
end
%
% Touch days, non touch days, touch hours, non touch hours
%
for k=1:a
    array(k,6)=sum(td(k,:));
    array(k,7)=array(k,4)-array(k,6);
    array(k,8)=sum(tdsc(k,:));
    array(k,9)=sum(ntdsc(k,:));

```

```

    if(sum(rst(k,:))>=1)
        array(k,10)=sum(rst(k,:))-1;
    else
        array(k,10)=sum(rst(k,:));
    end
end
xd=horzcat(cd',td',tdnc',tdsc',ntd',ntdsc',rst');

```

Z

Input Z of 90605 rows by 4 columns is as identified before for the Product engine controls area.

XD

Outputs are XD the detailed baseline values capturing the charged days, the touch days, the number of charges on touch days, the number of non touch days, the sum of charges on non touch days, and the number of restarts. Note that a column is generated for each jobs and for each of these dimension. Thus for the 3 jobs 5 employees model the size of this output is 760 rows (the number of days from the earliest charge to the latest charge) by 441 columns (ie there are provisions for 63 jobs times 7 variables). A sample of XD (details_baseline) is provided below, where the values correspond to the quantity of touch charged realized on each given day for each given job:

TC Job1	TC Job2	TC Job3	TC Job4	TC Job5	TC Job6	TC Job7	TC Job8
1	0	0	0	0	0	0	0
7	0	0	0	0	0	0	0
175	0	4	0	0	0	3	0
173	0	2	0	0	0	3	0
173	0	2	0	0	0	2	0
172	0	2	0	0	0	3	0
160	0	1	0	0	0	2	0
7	0	0	0	0	0	1	0
4	0	0	0	0	0	0	0
152	0	3	0	0	0	3	0
162	0	2	0	0	0	3	0

ARRAY

Another output is array (metric_baseline). Dimensions are 64 rows (2 empty) by 11 columns: Columns are as indicated below. Compare to similar metrics derived initially.

Start date	end date	Calendar days	Working days	Charged hours	Touch days	Non touch days	Touch days charged hours	Non touch days charged hours	Restarts	Nodes
38961	39721	1064	760	308469.9	738	22	273817.7	34178.65	0	82
39022	39192	238	170	1094.09	93	77	1051.32	42.77	2	12
39385	39628	340.2	243	6703.88	183	60	6600.76	103.12	1	9
39093	39496	564.2	403	431.16	98	305	425.91	5.25	2	2
39615	39681	92.4	66	16	5	61	15	1	1	2
39020	39065	63	45	223.51	26	19	210.76	12.75	0	4
39342	39665	452.2	323	3960.59	152	171	3933.71	26.88	2	5
39020	39054	47.6	34	196.99	26	8	196.99	0	0	2
39020	39136	162.4	116	117	24	92	90	27	3	2
39020	39066	64.4	46	411.22	33	13	390.71	20.51	0	6

LEAN_METRIC.M

This function analyzes the output of the simulation and generates lean metrics

```
function [xd z array] = lean_metric(time1, time2, time3, time4, time5,
timeother, job1, job2, job3, job4, job5, jobother, ee1, ee2, ee3,
ee4, ee5, eeother, chghr1, chghr2, chghr3, chghr4, chghr5,
chghrother, len1, len2, len3, len4, len5, lenother)
```

```
%
```

```
% Generate lean engineering metrics
```

```
% Input data is formed by the prior vertcat of relevant simulation data
```

```

% from workspace.

% Columns are ee#, time, charged hours, job # and average queue length
% Output data corresponds to mxn matrix of m jobs by n lean metrics
% Column 1 to 10 of data are start date, end date, duration, working
days, charged
% hours, touch days, non touch days, touch hours, non touch hours,
restarts, number of nodes
%
time=vertcat(time1.time, time2.time, time3.time, time4.time,
time5.time, timeothereee.time);
job=vertcat(job1.signals.values, job2.signals.values,
job3.signals.values, job4.signals.values, job5.signals.values,
jobothereee.signals.values);
chghr=vertcat(chghr1.signals.values, chghr2.signals.values,
chghr3.signals.values, chghr4.signals.values, chghr5.signals.values,
chghrothereee.signals.values);
ee=vertcat(ee1.signals.values, ee2.signals.values, ee3.signals.values,
ee4.signals.values, ee5.signals.values, eeothereee.signals.values);
len=vertcat(len1.signals.values, len2.signals.values,
len3.signals.values, len4.signals.values, len5.signals.values,
lenothereee.signals.values);
z=horzcat(ee, time, chghr, job,len);
[m,n] = size(z);
[d e f]=unique(z(:,4));
a=size(d);%number of unique jobs
array=zeros(a+1,11);
array(:,1)=1e10;%to get minimum
%
% Start date, end date, duration, working days, charged hours

```

```

%
for k = 1:m
    array(z(k,4),1)=min(array(z(k,4),1),z(k,2));
    array(z(k,4),2)=max(array(z(k,4),2),z(k,2));
    array(z(k,4),4)=(array(z(k,4),2)-array(z(k,4),1))/7.75;%38.75 hours
per 5 days week
    array(z(k,4),3)=array(z(k,4),4)*1.4;
    array(z(k,4),5)=array(z(k,4),5)+z(k,3);
    %array(z(k,4),6)=touch day calculation
    %array(z(k,4),7)=non touch day calculation
    %array(z(k,4),8)=touch hrs calculation
    %array(z(k,4),9)=restarts calculation
end
%
%Number of nodes
%
for l=1:a
    [i j]=size(unique(z(z(:,4))==l,1));
    array(l,11)=i;
end
%
% Charged days
%
cd=zeros(a,ceil(max(z(:,2)/7.75)));
tdnc=cd;
tdsc=cd;
td=cd;
ntd=cd;
ntdsc=cd;

```

```

rst=cd;
[i j]=size(cd);
for k = 1:m
    for l=1:j+1
        if (and(z(k,2)>((l-1)*7.75),z(k,2)<=l*7.75))
            cd(z(k,4),l)=cd(z(k,4),l)+1;
        end
    end
end
%
% Number of charges >2hrs by touch days (tdnc)
%
for k = 1:m
    for l=1:j+1
        if (and(z(k,2)>((l-1)*7.75),z(k,2)<=l*7.75))
            if(z(k,3)>=2)
                tdnc(z(k,4),l)=tdnc(z(k,4),l)+1;
            end
        end
    end
end
%
% Sum of charges >=2hrs by touch days (tdsc)
%
for k = 1:m
    for l=1:j+1
        if (and(z(k,2)>((l-1)*7.75),z(k,2)<=l*7.75))
            if(z(k,3)>=2)
                tdsc(z(k,4),l)=tdsc(z(k,4),l)+z(k,3);
            end
        end
    end
end

```



```

for k=1:i
    for l=1:j
        if(td(k,l)==1)
            o=l+11;
            if((j-o)>0)
                for p=l+1:o
                    rst(k,l)=rst(k,l)+td(k,p);
                end
                if (rst(k,l)>0)
                    rst(k,l)=0;
                else
                    rst(k,l)=1;
                end
            end
        end
    end
end
end
%
% Touch days, non touch days, touch hours, non touch hours
%
for k=1:a
    array(k,6)=sum(td(k,:));
    array(k,7)=max(0,array(k,4)-array(k,6));
    array(k,8)=sum(tdsc(k,:));
    array(k,9)=sum(ntdsc(k,:));
    if(sum(rst(k,:))>=1)
        array(k,10)=sum(rst(k,:))-1;
    else
        array(k,10)=sum(rst(k,:));
    end
end

```

```
end  
end  
xd=horzcat(td',tdnc',tdsc',ntd',ntdsc',rst');
```

Similar input and output as discussed previously.