

Manuscript Number:

Title: Experimental Study of Wind Effects on Unglazed Transpired Collectors

Article Type: Regular Paper

Keywords: wind tunnel; unglazed transpired collector; wind velocity distribution; convective heat loss

Corresponding Author: Ms. Neetha Vasam,

Corresponding Author's Institution:

First Author: Neetha Vasam

Order of Authors: Neetha Vasam; Theodore Stathopoulos

Abstract: High wind velocity affects the performance of unglazed transpired collectors (UTC); indeed, wind flow on the collector's surface reduces useful heat transferred to the collector fluid by effectuating convection losses and suction in the pores and thereby outflow from the plenum. Wind does not impinge uniformly on all points on a large area; the velocity distribution depends on wind direction and surroundings of the concerned area. The paper describes an experimental and analytical parametric study to assess the effect of wind on UTCs. Velocity measurements obtained using wind-tunnel experiments were applied to analytical models of UTC performance evaluation and were found to influence UTC performance. The assumption that a reference wind speed acts uniformly throughout the UTC area, as opposed to the more realistic non-uniform distribution, resulted in the overestimation of heat exchange effectiveness up to 50% and underestimation of convective heat transfer coefficients up to 20%. The importance of using actual velocity distribution, as opposed to an assumed uniform velocity distribution in building simulation, has been discussed.

September 18, 2013

Y. Goswami  
Editor-in-Chief, Solar Energy  
University of South Florida, Tampa, FL, USA

**Re: Submission of manuscript to Solar Energy Journal**

Dear Mr. Goswami,

I am a recent graduate from Concordia University, Montreal, Canada, where I completed my Masters research under the supervision of Dr. Theodore Stathopoulos. Having graduated in May 2013, I am currently with RWDI Consulting Engineers Inc., Guelph, Ontario. Through this letter I intend to introduce and submit our manuscript titled “*Experimental Study of Wind Effects on Unglazed Transpired Collectors*” co-authored by Neetha Vasam and Theodore Stathopoulos, for exclusive consideration to have published in Solar Energy.

The paper describes an experimental study of the effects of wind direction and surrounding wind blockage on the performance of unglazed transpired collectors (UTC). It is my understanding that the methodology, study and topics discussed in this manuscript align with those in a number of papers previously published by Solar Energy such as:

- Athienitis, A. K., Bambara, J., O'Neill, B. & Faille, J., 2010. A prototype photovoltaic/thermal system integrated with transpired collector. *Solar Energy*, 85(1), pp. 139-153
- Fleck, B. A., Meier, R. M. & Matovic, M. D., 2002. A field study of the wind effects on the performance of an unglazed transpired solar collector. *Solar Energy*, 73(3), pp. 209-216.
- Gawlik, K. M. & Kutscher, C. F., 2002. Wind heat loss from corrugated, transpired solar collectors. *Journal of Solar Energy Engineering*, 124(3), pp. 256-261.
- Gunnewiek, L. H., Hollands, K. G. T. & Brundrett, E., 2002. Effect of wind on flow distribution in unglazed transpired-plate collectors. *Solar Energy*, 72(4), pp. 317-325.

We wish to declare the following:

- The work is all original research carried out by the authors.
- All authors agree with the contents of the manuscript and its submission to the journal.
- No part of the research has been published in any form elsewhere, unless it is fully acknowledged in the manuscript.
- The manuscript is not being considered for publication elsewhere while it is being considered for publication in this journal.

Thank you for taking the time to consider my submission.

Sincerely,



Neetha Vasam, M.A.Sc, LEED AP

RWDI Consulting Engineers  
Guelph, Ontario, Canada

# Experimental Study of Wind Effects on Unglazed Transpired Collectors

Neetha Vasana<sup>a,1</sup>, Theodore Stathopoulos<sup>b</sup>

<sup>a</sup>Graduate Student, <sup>b</sup>Professor

*Department of Building, Civil and Environmental Engineering, Concordia University,  
1455 de Maisonneuve Blvd. West, Montreal, QC H3G 1M8, Canada*

## Highlights

- Local wind velocities at the surface of a façade integrated unglazed transpired collector (UTC) were measured by wind tunnel testing.
- Wind velocities and convective heat loss across a UTC area are not uniform.
- Local velocities that affect UTCs are influenced by wind direction and surroundings.
- Maximum convective heat losses were found for winds at 45° to the UTC surface.
- An increase of 2 m/s in the wind speed reduces UTC efficiency by about 20%.

---

<sup>1</sup> Corresponding author. Current address: RWDI Inc., 650 Woodlawn Rd West, Guelph, ON N1K 1B8, Canada  
Phone: +1 5146191024 Email: neethamvasan@gmail.com

# Experimental Study of Wind Effects on Unglazed Transpired Collectors

Neetha Vasan<sup>a,1</sup>, Theodore Stathopoulos<sup>b</sup>

<sup>a</sup>Graduate Student, <sup>b</sup>Professor

Department of Building, Civil and Environmental Engineering, Concordia University,  
1455 de Maisonneuve Blvd. West, Montreal, QC H3G 1M8, Canada

## Abstract

High wind velocity affects the performance of unglazed transpired collectors (UTC); indeed, wind flow on the collector's surface reduces useful heat transferred to the collector fluid by effectuating convection losses and suction in the pores and thereby outflow from the plenum. Wind does not impinge uniformly on all points on a large area; the velocity distribution depends on wind direction and surroundings of the concerned area. The paper describes an experimental and analytical parametric study to assess the effect of wind on UTCs. Velocity measurements obtained using wind-tunnel experiments were applied to analytical models of UTC performance evaluation and were found to influence UTC performance. The assumption that a reference wind speed acts uniformly throughout the UTC area, as opposed to the more realistic non-uniform distribution, resulted in the overestimation of heat exchange effectiveness up to 50% and underestimation of convective heat transfer coefficients up to 20%. The importance of using actual velocity distribution, as opposed to an assumed uniform velocity distribution in building simulation, has been discussed.

Keywords: wind tunnel; unglazed transpired collector; wind velocity distribution; convective heat loss

## 1. Introduction

Sustainability gained immense importance over the past few decades. There has been commendable growth, worldwide, in the solar thermal industry – over 20% annually as reported by Natural Resources Canada (NRCAN, 2010) – due to both the abundance of solar energy in several parts of the world and technological innovations that make this energy accessible. High performance of solar thermal devices is brought about by reducing heat loss to a minimum. In

---

### ABBREVIATIONS

BIPV/T = building-integrated photovoltaic/thermal  
CFD = computational fluid dynamics  
CHTC = convective heat transfer coefficient

JMSB = John Molson School of Business  
UTC = unglazed transpired collector

<sup>1</sup> Corresponding author. Current address: RWDI Inc., 650 Woodlawn Rd West, Guelph, ON N1K 1B8, Canada  
Phone: +1 5146191024 Email: [neethamvasan@gmail.com](mailto:neethamvasan@gmail.com)

this regard, wind-induced convection heat loss is a major concern and extensive studies with improved wind simulations are necessary to arrive at generalized guidelines for efficient system design.

UTCs are one of the most efficient solar heating technologies available today. Introduced in 1989 (NREL, 1998), UTCs consist of a dark absorber cladding with 0.5% to 2% of the area made up of perforations (Dymond & Kutscher, 1997) installed about 10 to 20 centimeters off the equator-facing wall of a building, forming a plenum behind the cladding – see schematic in Figure 1. Heat absorbed by the metal cladding forms a layer of warm air on either of its sides. Warm air is drawn in through the perforations by means of a fan located behind the cladding at the top and transferred through a distribution duct system into indoor spaces. In addition to space-heating, UTCs are known to have been used for crop-drying in barns and heating swimming pools. The U. S. Department of Energy claims this technology to be the most efficient air heating system available today – 75% efficiency as claimed by Solarwall® (Heinrich, 2007).

## 2. Background Knowledge

### 2.1 Wind effects on UTC

UTC performance is governed by a number of factors such as ambient temperature, wind speed, properties of the absorber plate, pitch and diameter of the perforations, air suction rate etc., most of which have been addressed in various past research studies. One of the first studies of wind effects on UTCs was by Kutscher (1992) followed by Kutscher, et al. (1993) who theoretically examined different modes of heat loss from UTCs and derived relations for convective heat loss  $Q_{conv}$  and thermal efficiency  $\eta$ , a term that defines how much of the available thermal energy the collector converts into useful form by heating air:

$$Q_{conv} = 0.82(V_{\infty}v/V_s^2)W[\rho c_p V_s(T_{coll} - T_{amb})] \quad (1)$$

$$\eta = \alpha_s \left[ 1 + (h_r/\epsilon + h_c)(\rho c_p V_s)^{-1} \right]^{-1} \quad (2)$$

where,  $V_{\infty}$  is the free stream wind velocity,  $V_s$  is the velocity with which air is drawn through the UTC perforations,  $T_{coll}$  and  $T_{amb}$  are temperatures of the collector surface and ambient air respectively,  $h_r$  and  $h_c$  are coefficients of heat transfer by radiation and convection respectively and  $\epsilon$  is the plate heat exchange effectiveness. Air exiting at the back of the plate, i.e. the outlet air, is at a lower temperature than the plate surface. Plate heat exchange effectiveness, the air heating effect of the plate, relates the outlet air temperature  $T_{back}$  to the plate surface temperature and ambient air temperature:

$$\epsilon = (T_{back} - T_{amb})/(T_{coll} - T_{amb}) \quad (3)$$

The research was extended to experimental analysis in a wind tunnel to assess the effect of cross-wind (Kutscher, 1994) and later on a numerical model, validated by wind tunnel tests and hotwire anemometry (Gawlik & Kutscher, 2002).

Van Decker, et al. (2001) studied the effect of plate thickness, pore size, shape and orientation on the heat exchange effectiveness  $\epsilon$  of the UTC. On the basis of experimental measurements and theoretical models available in previous literature, the study developed

predictive models for heat exchange effectiveness at the front  $\epsilon_f$ , holes  $\epsilon_h$  and back  $\epsilon_b$  of the collector plate and  $\epsilon$  was expressed as follows:

$$\epsilon = 1 - (1 - \epsilon_f)(1 - \epsilon_h)(1 - \epsilon_b) \quad (4)$$

$$\epsilon_f = \frac{1}{1 + Re_s \min \left[ aRe_w^{-\frac{1}{2}}, f \right]} \quad (5)$$

$$\epsilon_h = 1 - \exp \left[ -4 \left( c \frac{P}{D} + \frac{3.66}{PrRe_h} \frac{t}{D} \right) \right] \quad (6)$$

$$\epsilon_b = \left( 1 + eRe_b^{\frac{1}{3}} \right)^{-1} \quad (7)$$

where,  $Re$  is the Reynolds number,  $t$  is the plate thickness,  $D$  and  $P$  are diameter and pitch of the UTC perforations. Through experiments and global regression fitting, the values of the constants in equations (5) through (7) were found to be  $a=1.733$ ,  $c=0.004738$ ,  $e=0.2273$ ,  $f=0.02136$  and  $Pr=0.71$  (for air). By combining equations (4) through (7) and applying the constants, the heat exchange effectiveness of a UTC with square-hole geometry was expressed as follows:

$$\epsilon = \left[ 1 - \left( 1 + Re_s \max \left[ 1.733Re_w^{-\frac{1}{2}}, 0.02136 \right] \right)^{-1} \right] \times \left[ 1 - \left( 1 + 0.2273Re_b^{\frac{1}{3}} \right)^{-1} \right] \times \exp \left( -0.01895 \frac{P}{D} - \frac{20.62}{Re_h} \frac{t}{D} \right) \quad (8)$$

Fleck, et al. (2002) conducted field tests on UTC and showed that turbulent fluctuations outside the boundary layer enhance convective losses on the UTC surface. Peak collector efficiency was observed at wind speeds between 1 and 2 m/s, not at zero wind speed as postulated by Kutscher (1993). This was confirmed later by Cordeau & Barrington (2011) who also conducted field measurements on UTC for broiler barns and found a maximum efficiency of 65% for wind velocities below 2 m/s but efficiencies below 25% for wind velocities above 7 m/s. Fleck, et al. (2002) stated that the relation between collector efficiency and wind direction, based on their results, was inconclusive due to lack of sufficient data. The study addressed certain drawbacks in Kutscher's studies viz. the use of laminar uniform flow parallel to the ground, which in reality is not the case of flow around bluff bodies.

Above certain velocities, depending on the air intake rate of the collector, wind parallel to the collector's surface causes suction in the pores and thereby outflow resulting in loss of useful heat being carried by the plenum air (Fleck, et al., 2002). This was studied by Gunnewiek, et al. (2002) who recommended minimum suction velocities to avoid such reverse flow.

Athienitis, et al. (2010) designed and developed a prototype PV/thermal panel that consisted of a UTC system with 70% of its area covered by PV panels (O'Neill, et al., 2011). Ventilation air is preheated by heat from the PV as well as the UTC. This system was integrated into the façade of an institutional building in Montreal, Canada. The design and initial analysis of the system assumed parallel wind flow (Athienitis, et al., 2010). In reality, predominant winds for the location of the building are normal to the building integrated photovoltaic/thermal (BIPV/T) wall as opposed to parallel flows commonly considered in many previously published studies that dealt with heat loss from UTC. Wind effects on the performance of this UTC were

studied by Vasan and Stathopoulos (2012) using wind tunnel experiments; preliminary results showed that wind direction did indeed have an impact on UTC efficiency.

## 2.2 Convective heat transfer coefficients (CHTC) on vertical façades

Jürges (1924), in a wind tunnel study, measured heat transfer from a vertical heated plate attached to the sidewall of the wind tunnel for a range of free stream wind tunnel velocities  $V_\infty$  and developed the following relation:

$$h_c = 4.0V_\infty + 5.6 \quad \text{for all wind directions} \quad (9)$$

Flat plates attached to the walls of a wind tunnel did not form the best representation for heat transfer from buildings under the influence of complex air flows; this led to the initiation of studies specifically for application to building surfaces. The general methodology for full scale studies of CHTC on building surfaces involves thermal measurements on heated metal strips positioned high on the walls of tall buildings and wind velocity measurements at two locations in the least –  $V_{ref}$  above the building roof and  $V_{loc}$  at a small distance, 0.3 to 2 m, from the test wall. CHTC-wind velocity relations thus developed and available in literature that are relevant to the present study are summarized in Table 1. Notation for wind direction differs from study to study; therefore, for consistency this paper follows the notation illustrated in Figure 2. The studies differed in a number of aspects such as dimensions of the building and test plate, surrounding terrain, measurement distance from the building surface, time and duration of velocity and temperature measurement etc. For this reason, the relations developed show very little agreement with each other as can be seen from the comparison shown in Figure 3; one has to be mindful of the test conditions when selecting one or more of these relations.

In most of these studies, wind directions were classified as windward and leeward only. Liu & Harris (2007) and Blocken et al. (2009), on the other hand, provide direction specific CHTC- $V_{loc}$  relations (Table 1, equations 14 through 19). It is known and has been confirmed in literature (Sharples, 1984; Fleck, et al., 2002; Shao, et al., 2010) that natural convection losses are prevalent at zero wind speeds. This is not reflected in the power relations provided by Blocken (2009) – CHTC is zero for zero wind velocity. As can be seen in Figure 3, the relations by Liu & Harris (2007) generate results that lie in between the range over which the results of other studies vary. Moreover, these relations were based on full-scale data that was categorized into directional segments, which reduced scatter in CHTC versus velocity plots and resulted in better regression fits.

Wind velocity impinging on a large area, such as a UTC, is not the same at all points. In other words, the wind velocity distribution is not uniform; it depends on wind direction, building orientation and surroundings structures that influence local wind flow patterns around the building under concern. However, it is common practice to assume a uniform distribution for ease of calculations related to thermal collectors. To the best of our knowledge, there have been no comprehensive findings relating wind direction to UTC performance. The objective of this study was to investigate the effect of wind direction as well as the error in assuming a uniform local velocity distribution for UTC performance evaluation. Detailed wind speed distribution in front of the John Molson School of Business (JMSB) building of Concordia University, that houses a façade integrated UTC, was measured by means of wind tunnel experiments on a reduced-scale model and the information obtained was applied to existing analytical models of convective heat loss, heat exchange effectiveness and efficiency of the UTC. The significance of using accurate wind velocity distributions for design purposes is discussed in this paper.

### 3. Experimental setup and procedure

The Building Aerodynamics Laboratory at Concordia University, Montreal, was used for this study. The Laboratory houses an open circuit wind tunnel that has a working cross-section of 1.8m X 1.8 m, length of 12 m and an adjustable roof that renders any pressure gradient of the flow reaching the test section negligible. In order to assess the wind distribution on a vertical façade in a realistic condition, an existing building, in this case the JMSB building of Concordia University, Montreal, was chosen for the study. The building is 54 m tall and houses a 300 m<sup>2</sup> BIPV/T system (also referred to as solar-wall) consisting of a UTC with 70% of its area covered by PV panels (O'Neill, et al., 2011). The analysis in this paper is focused on the velocity distribution on vertical facades and its effect on UTC; therefore, for simplicity of the case study, it has been assumed that the UTC is a flat plate type. Figure 4 shows the location and orientation of the solar-wall. A 1:400 scale wooden model of the JMSB building was constructed (Figure 5) along with all surroundings within a full scale radius of 450 m in order to simulate the approach wind profile that the actual building encounters. Terrain roughness beyond the modeled area was configured using roughness elements such that the wind velocity profile developed at the test section had a power law exponent of 0.3, which represents the downtown wind profile in Montreal to sufficient accuracy. Two building cases were considered for the study:

- Case 1: Test building with all existing surroundings (Figure 6a)
- Case 2: Test building in the absence of immediate surroundings (Figure 6b)

The wind tunnel was operated at a speed of 12 m/s and local wind velocity at various locations on the area covered by the UTC system was measured using a Cobra Probe (Figure 7), which is a 4-hole pressure probe that measures velocity vector components, mean velocity vector and static pressure. Readings were taken at 40 measurement points on an 8×5 grid located 5 mm off the UTC area, as shown in Figure 8, which equals 2 m in full scale. Measurements were taken for three wind directions, described in see Table 2, chosen on the basis of their predominance in Montreal and relevance to the building integrated system. In addition, reference velocity at 6.25 mm above the roof of the model, hereafter referred to as the reference height, was also measured for each configuration. This height, corresponding to 2.5 m above the roof in full scale, is the location of the anemometer that provided the full scale reference wind-speeds.

### 4. Results and discussion

Since the study aimed to examine the error in assuming a uniform wind velocity distribution, rather than the more realistic (non-uniform) directional wind velocity distribution on a large area, four velocity distributions were considered for each test case: the assumed uniform distribution (roof level velocity  $V_{ref}$  acts normal to the surface and uniformly at all points) and the local velocity ( $V_{loc}$ ) distributions for the three wind directions tested.

#### 4.1 Local velocity distribution near the UTC surface

Wind tunnel tests are done on scaled models of the subject therefore, the best way to express measured parameters are in the form of dimensionless coefficients. Figure 9 shows the distribution of local velocity coefficients – defined as the ratio of the magnitude of  $V_{loc}$  to  $V_{ref}$  – for all test configurations. In general, blockage in the form of buildings, landscaping, vegetation etc., causes mean wind speeds reaching a target building to be lower than what would be expected in an open area without as much blockage. However, local winds close to and around a



building are affected by immediate surroundings that may create turbulence and thereby higher local velocities. The results indicate that local velocities in Case 1 are, on average, about 20% to 30% higher than in Case 2. This quantifies the impact of surrounding structures on the wind flow near the JMSB building.  $V_{loc}$  near building edges are up to 50% higher than  $V_{ref}$  due to flow acceleration, highest values being for the 45° winds.

For analysis using full-scale velocities,  $V_{loc}$  for any point on the solar-wall area may easily be obtained by multiplying the corresponding velocity coefficient by  $V_{ref}$ . Typical wind speeds at JMSB were found to be of the order of 1 m/s as recorded by the roof-mounted anemometer. Results in the following sections have been classified as pertaining to reference wind speeds of 1 m/s (low wind condition) and 3 m/s (high wind condition).

#### 4.2 Convective heat transfer coefficient $h_c$

Since this study did not involve thermal measurements, CHTC  $h_c$  for the UTC was estimated by applying the experimental results of  $V_{loc}$  into analytical models relating CHTC to  $V_{loc}$ . The detailed directionality classification of the relations developed by Liu & Harris (2007) – see Table 1, equations 14 through 16 – represents wind-induced CHTC better than the broad classification as windward and leeward only that had been the norm in previous studies. The test building in that study faced the predominant wind direction (Liu & Harris, 2007) and experienced wind speeds similar to those at the top of the JMSB building. Such similarities made it reasonable to adopt these relations for the present analysis. CHTC for the assumed uniform normal distribution case was obtained by replacing  $V_{loc}$  in the equations by  $V_{ref}$ . Error in surface-averaged CHTC as a result of using the assumed uniform velocity distribution in place of actual distributions for the three wind directions, presented in Table 3, were calculated as:

$$\%Error = \frac{Value\ for\ assumed\ distribution - Value\ for\ actual\ distribution}{Value\ for\ actual\ distribution} \times 100 \quad (10)$$

Positive values indicate an overestimation as a result of the assumption. The assumed uniform distribution, led to an overestimation of the surface-averaged CHTC by up to 16% for 90° and 19% for 0° in Case 1. For the 45° direction however, results from the actual distribution are higher than the assumed case by 10% for low wind speeds and the error is almost double for high wind speed (19%). This is a direct result of the high local wind speeds corresponding to this angle of approach and warrants more attention. The presence of surroundings seems to effectuate higher convection heat transfers due to accelerated flows. Had there been no surrounding structures, CHTC would have been, on average, about 30% lower than the existing condition. This can be estimated from the values in Table 3.

#### 4.3 UTC Plate heat exchange effectiveness $\epsilon$

As explained previously, heat exchange effectiveness  $\epsilon$  represents the air heating ability of the absorber plate. Once the value of this parameter is known, the thermal efficiency of a UTC can be calculated with ease using equation (2). Existing models for  $\epsilon$  as a function of wind velocity assume that the wind acts normal to the UTC plate and the pores. Therefore, calculations of  $\epsilon$  for this study were done by applying  $V_{normal}$  in equation (8) developed by Van Decker et al. (2001).  $V_{normal}$  at each measurement point is the vector resolute of  $V_{loc}$  to the building normal at the same point. In order to apply the velocity distribution to this model, it was assumed that the transpired collector wall was composed of 40 individual collector plates, each

represented by one measurement point – see Figure 8. Each collector was assumed to have been subjected to a different velocity and the net effect of all 40 collectors working together in parallel was considered for overall plate heat exchange effectiveness  $\epsilon$ .

The distributions of  $V_{normal}$  on the UTC wall surface for the three wind directions are shown in Figure 10 and the variations of plate heat exchange effectiveness for the different wind directions and the two test cases are shown in Figure 11. Of the three wind directions,  $0^\circ$  wind is seen to effect maximum plate heat exchange effectiveness. Farther the deviation of wind angle from the solar-wall normal, lower the magnitude of  $V_{normal}$ , hence lower the value of  $\epsilon$ . It can also be seen that with increase in free stream velocity, hence increase in normal velocity component,  $\epsilon$  increases until it reaches a maximum beyond which the curve is asymptotic. This behavior is typical of perforated plates subjected to wind (Kutscher, 1994). Based on the results, assuming uniform distribution of reference wind speed over the entire test area overestimates the effectiveness values, the most significant difference being 50% for low winds that are prevalent in the JMSB area – see Table 4.

#### 4.4 UTC thermal efficiency $\eta$

Thermal efficiency  $\eta$  of a UTC defines how much of the available solar thermal energy is converted into useful form by heating air. Surface-averaged CHTC  $h_c$  and over-all heat exchange effectiveness  $\epsilon$  for the UTC calculated for different reference velocities and directional distributions for the two proximity model cases were applied to Kutscher's model (1993) for UTC thermal efficiency – equation (2). Figure 12 shows the comparison between calculated results for assumed and actual velocity distributions. The variability in directional wind speed distributions and the corresponding effects on  $h_c$  and  $\epsilon$  seem to balance out in the prediction of thermal efficiency on which wind direction seems to have very little effect. The errors in using the assumed distribution as opposed to actual distributions are shown in Table 5. Wind speed, however, is shown to reduce  $\eta$  – a reduction by 20 percentage points is seen for the range of wind speeds measured at JMSB. For a UTC working under typical conditions at say, 50% efficiency in a geographic region receiving an average  $800 \text{ W/m}^2$  of solar irradiance at peak hours, reduction of thermal efficiency to 30% would be calculated as follows:

Thermal energy collected at 50% efficiency

$$Q_{50} = 50/100 \times 800 \text{ W/m}^2 \times 1\text{hr} = 400 \text{ W.hr/m}^2$$

Thermal energy collected at 30% efficiency

$$Q_{30} = 30/100 \times 800 \text{ W/m}^2 \times 1\text{hr} = 240 \text{ W.hr/m}^2$$

The difference between  $Q_{50}$  and  $Q_{30}$ ,  $160 \text{ W.hr/m}^2$ , is the heat lost through convection. The 20 percentage point reduction is a direct difference between the  $\eta$  values corresponding to 1 and 3 m/s; it should not be confused with the percentage errors presented in Table 5 which were calculated using equation (10) to show the effect of wind direction.

UTC thermal efficiency is largely dependent on the convective heat loss term; it has been shown that the assumed velocity distribution highly overestimates convective heat loss; the corresponding effect is an underestimation of  $\eta$ . Comparing Case 1 and Case 2 in Figure 12 and Table 5, it can be seen that the effect of immediate surroundings for the building studied is most significant for the  $0^\circ$  direction. The lower  $\eta$  in Case 1 is due to higher CHTC as a result of higher localized wind acceleration brought about by the surrounding structures.

#### **4.5 Comparison of thermal efficiency results with Bambara (2012)**

The solar-wall studied in this paper was the subject of an experimental study by Bambara (2012) in a solar simulator at Concordia University. The solar simulator is an indoor research facility that reproduces natural sunlight and allows for testing of solar systems in controlled laboratory environments. The experimental setup included a fan fixed below the UTC test panel, that was used to blow a jet of air parallel to the test panel.

The results of the present study, for parallel wind distribution and assumed uniform normal distribution, for reference wind speeds of 1 and 3 m/s have been compared to those presented by Bambara (2012) – see Figure 13. In addition to the observation that thermal efficiency of the UTC increases with increase in air collection rate (Bambara, 2012), it can also be seen from Figure 13 that a wind speed increase from 1 to 3 m/s has the potential of decreasing the thermal efficiency by about 20 percentage points – this has been confirmed in the present study. Although the results of the two studies are in close agreement; the solar-simulator results, are closer to the values for the assumed uniform wind speed distribution in the present study, especially for the high wind condition. This was expected based on the assumption of uniform distribution in that study. Bambara (2012) assumed a vertical parallel flow over the UTC based on bluff body aerodynamics and the presence of a stagnation point. However, this is only true for winds that approach the building without the influence of any obstructions. For buildings located in an urban setting, surrounded by buildings of similar heights, this is seldom the case. The present study addressed this aspect with the inclusion of proximity models for more accurate flow simulation.

### **5. Practical implications and building simulation**

As discussed in the previous sections, the most critical effect wind can have on UTC is the removal of useful heat leading to reduced thermal efficiency. This study presents an estimated reduction of thermal efficiency by 20 percentage points due to both wind speed and direction.

Most research studies in the past dealing with wind distribution on vertical walls were limited to terrain conditions with little or no obstruction to the flow. This is seldom the case in reality; local wind velocities and velocity distribution patterns are effects of the upstream terrain conditions and immediate surroundings of the concerned surface. Therefore existing correlations for local wind velocities, although broadly accepted for application to conditions similar to those they were developed in, cannot be generalized. A method to incorporate terrain condition factors into these correlations is desirable for greater accuracy in estimation of local winds.

Due to the fact that the nature of immediate surroundings varies from building to building, it is advisable to use a combination of appropriate roughness lengths and scaled proximity models when simulating flow around buildings. This will allow for local wind turbulence and flow around surrounding structures to be better simulated as compared to the use of roughness length alone to generate the velocity profile. This measure is simpler in flow simulation programs where proximity models can be simulated as separate entities. However, in thermal simulation tools like DOE, ESP-R etc. where the external environment is simulated based on representative numerical inputs, the task of using accurate wind distributions may be difficult at this point. External coupling of flow and thermal simulation programs by which both domains may be synchronized and coupled (Djunaedy, et al., 2004; Mirsadeghi, et al., 2008) could be a way to get around this limitation.

## 6. Conclusions and further thoughts

This study is an attempt to demonstrate the significance of using actual velocity distributions on large areas, as opposed to a single velocity value measured at a reference location, for UTC analyses. Velocity distribution on the solar-wall façade of the JMSB building was measured experimentally in a wind tunnel and a sensitivity study was done by applying the velocity distributions to performance evaluation models of UTCs. Proximity models were included in the wind tunnel tests to assess the impact of other structures in the vicinity on the wind velocity distributions. The following are the main conclusions from the study:

- Actual directional distributions of wind velocity showed that local velocities, especially those near building edges, could be up to 50% higher than those measured above the roof owing to flow acceleration at these areas.
- Winds at an incidence angle of  $45^\circ$  to the UTC were shown to have the greatest effect on CHTC and heat exchange effectiveness; CHTC values calculated were about 20% higher than those for an assumed wind speed distribution and heat exchange effectiveness values were up to 50% lower for this orientation.
- CHTC was found to have dominance over heat exchange effectiveness in the prediction of thermal efficiency.
- Typical wind speeds measured at the JMSB rooftop were found to be of the order of 1 m/s; high wind speeds were generally around 3 m/s. This range of wind speeds was found to reduce the UTC thermal efficiency by up to 20 percentage points.
- Surrounding structures are seen to have a notable influence on the flow around the JMSB building; the local wind velocities were about 20% - 30% lower without proximity models than with proximity models. The most significant effects were for  $0^\circ$  winds, which is the predominant direction in the JMSB area. Local flow patterns are highly dependent on the immediate surroundings and are very difficult to generalize. This emphasizes the importance of including proximity models in the wind related studies for more accurate simulation of the wind flow around the test building in both experimental and computational studies.

Although this study refers to a particular building – the JMSB – the qualitative results are expected to be applicable to other buildings in similar circumstances.

There have been very few studies in the past that aimed to develop direction specific correlations between UTC performance parameters and local wind speeds; existing correlations show little agreement with each other as they were developed for different experimental conditions. It would be interesting to see the development of more standardized correlations that would allow easier prediction and application of wind velocity distribution on building surfaces. A method to incorporate terrain condition factors into these correlations is desirable for greater accuracy in estimation of local winds. Further investigation through full-scale studies and CFD modeling could provide detailed insights into the wind effects on UTC performance. An ideal study set-up would be one where the simulation functions of a wind tunnel and solar simulator could be combined to investigate the wind effects and corresponding thermal changes simultaneously. The continual appraisal of technology and growing sophistication of control systems enables efficient management of energy flow in buildings. In order to maximize the functionality of such systems, there is constant need for greater accuracy in simulating real-world conditions.

## Nomenclature

$a, c, e, f$	constants in equations (5) through (7)
$c_p$	specific heat of air at constant pressure (J/kgK)
$D$	UTC hole diameter (m)
$h_c$	convective heat transfer coefficient (W/m <sup>2</sup> K)
$h_r$	radiative heat transfer coefficient (W/m <sup>2</sup> K)
$P$	UTC hole pitch (m)
$Pr$	Prandtl number
$Q_{conv}$	convective heat loss (W/m <sup>2</sup> )
$Q_{30}, Q_{50}$	Thermal energy collected at 30% and 50% UTC thermal efficiency (W.hr/m <sup>2</sup> )
$Re$	Reynolds number; $Re_w = \frac{V_{wind}P}{\nu}$ $Re_s = \frac{V_sP}{\nu}$ $Re_b = \frac{V_sP}{\nu\sigma}$ $Re_h = \frac{V_sD}{\nu\sigma}$
$t$	UTC plate thickness (m)
$T_{amb}$	temperature of ambient air (°C)
$T_{back}$	temperature of the air coming out at the back of the collector (°C)
$T_{coll}$	temperature at the collector surface (°C)
$V_{10}$	reference wind velocity at 10 m height in the upstream undisturbed flow (m/s), usually measured at a weather station
$V_{\infty}$	free stream velocity parallel to the UTC (m/s)
$V_{loc}$	magnitude of local wind velocity vector (m/s)
$V_{normal}$	component of $V_{loc}$ normal to the building or UTC surface (m/s)
$V_{ref}$	reference wind velocity measured above the roof (m/s)
$V_s$	suction velocity in the UTC pores (m/s)
$V_{wind}$	approach wind velocity (m/s)
$W$	width of the collector (m)
$\alpha$	power law exponent
$\alpha_s$	solar absorptance of the collector surface
$\epsilon$	UTC plate heat exchange effectiveness
$\epsilon_f, \epsilon_h, \epsilon_b$	heat exchange effectiveness at the front, hole and back of the plate respectively
$\eta$	UTC thermal efficiency
$\nu$	kinematic viscosity of air (m <sup>2</sup> /s)
$\rho$	density (kg/m <sup>3</sup> )
$\sigma$	UTC porosity

## References

- Athienitis, A. K., Bambara, J., O'Neill, B. & Faille, J., 2010. A prototype photovoltaic/thermal system integrated with transpired collector. *Solar Energy*, 85(1), pp. 139-153.
- Bambara, J., 2012. *Experimental Study of a Façade-integrated Photovoltaic/thermal System*, M.A.Sc thesis: Concordia University, Montreal, Canada.
- Blocken, B., Defraeye, T., Derome, D. & Carmeliet, J., 2009. High-resolution CFD simulations for forced convection heat transfer coefficients at the facade of a low-rise building. *Building and Environment*, 44(12), pp. 2396-2412.
- CIBSE, 2006. *Chartered Institute of Building Services Engineers Guide Book A, Section A3*. London: CIBSE.
- Cordeau, S. & Barrington, S., 2011. Performance of unglazed solar ventilation air pre-heaters for broiler barns. *Solar Energy*, 85(7), pp. 1418-1429.
- Djunaedy, E., Hensen, J. L. M. & Loomans, M. G. L. C., 2004. *Comparing internal and external run-time coupling of CFD and building energy simulation software*. Coimbra, Portugal, Proceedings of the 9th ROOMVENT International Conference on Air Distribution in Rooms, 5-8 September 2004, University of Coimbra, pp. 393-396.
- Dymond, C. & Kutscher, C., 1997. Development of a flow distribution and design model for transpired solar collectors. *Solar Energy*, 60(5), pp. 291-300.
- Fleck, B. A., Meier, R. M. & Matovic, M. D., 2002. A field study of the wind effects on the performance of an unglazed transpired solar collector. *Solar Energy*, 73(3), pp. 209-216.
- Gawlik, K. M. & Kutscher, C. F., 2002. Wind heat loss from corrugated, transpired solar collectors. *Journal of Solar Energy Engineering*, 124(3), pp. 256-261.
- Gunnawiek, L. H., Hollands, K. G. T. & Brundrett, E., 2002. Effect of wind on flow distribution in unglazed transpired-plate collectors. *Solar Energy*, 72(4), pp. 317-325.
- Heinrich, M., 2007. *Transpired Solar Collectors - Results of a Field Trial*, Juddgeford, New Zealand: BRANZ Ltd.
- Ito, N., Kimura, K. & Oka, J., 1972. A field experiment study on the convective heat transfer coefficient on exterior surface of a building. *ASHRAE Transactions*, 79(1), pp. 184-191.
- Jürges, W., 1924. Der Wärmeübergang an einer ebenen Wand. *Beihefte zum Gesundheits-Ingenieur*, 1(19), pp. 1227-1249. Cited in: Sharples, S., 1984. Full-scale measurements of convective energy losses from exterior building surfaces. *Building and Environment*, 19(1), pp. 31-39.
- Kutscher, C. F., 1992. *An investigation of heat transfer for air flow through low porosity perforated plates*, University of Colorado, Colorado, USA: s.n.
- Kutscher, C. F., 1994. Heat exchange effectiveness and pressure drop for air flow through perforated plates with and without crosswind. *Journal of Heat Transfer*, 116(2), pp. 391-399.
- Kutscher, C. F., Christensen, C. B. & Barker, G. M., 1993. Unglazed transpired solar collectors: heat loss theory. *Journal of Solar Energy Engineering*, 115(3), pp. 182-188.

- Liu, Y. & Harris, D. J., 2007. Full-scale measurements of convective coefficient on external surface of a low-rise building in sheltered conditions. *Building and Environment*, 42(7), pp. 2718-2736.
- Mirsadeghi, M., Blocken, B. & Hensen, J. L. M., 2008. *Validation of external BES-CFD coupling by inter-model comparison*. Kyoto, Japan. In Murakami, S (Ed.), 29th AIVC Conference, 14-16 October 2008, pp. 193-198.
- NRCan, 2010. *Solar Thermal*. [Online]  
Available at: <http://canmetenergy.nrcan.gc.ca>  
[Accessed 15 November 2012].
- O'Neill, B., Chen, Y. & Koziol, A., 2011. *Description of the JMSB BIPV/T solar system, monitoring and database*, Montreal: Solar Buildings Research Network.
- Shao, J. et al., 2010. Field measurement of the convective heat transfer coefficient on vertical external building surface using naphthalene sublimation method. *Journal of Building Physics*, 33(4), pp. 307-326.
- Sharples, S., 1984. Full-scale measurements of convective energy losses from exterior building surfaces. *Building and Environment*, 19(1), pp. 31-39.
- Van Decker, G. W. E., Hollands, K. G. T. & Brunger, A. P., 2001. Heat-exchange relations for unglazed transpired solar collectors with circular holes on a square or triangular pitch. *Solar Energy*, 71(1), pp. 33-45.
- Vasan, N. & Stathopoulos, T., 2012. *Wind Tunnel Assessment of the Wind Velocity Distribution on*. Halifax, Canada, Proceedings of eSim 2012: The Canadian Conference on Building Simulation, 1-4 May 2012, pp. 61-74.

## TABLES AND FIGURES

**Table 1: CHTC-Wind velocity relations from literature for vertical building surfaces**

Study	$h_c - V_{loc}$ relation	Equation Number	Applicable wind direction	Distance of $V_{loc}$ measurement from building surface
Ito, et al. (1972)	$h_c = 18.6V_{loc}^{0.605}$	(11)	All	0.3 m
Sharples (1984)	$h_c = 1.7V_{loc} + 5.1$	(12)	All	1 m
CIBS Guide Book (2006)	$h_c = 4V_{loc} + 4$	(13)	All	Not available
Liu & Harris (2007)	$h_c = 5.90V_{loc} + 3.95$	(14)	0°	0.5 m
	$h_c = 6.42V_{loc} + 3.17$	(15)	45°	
	$h_c = 7.42V_{loc} + 2.98$	(16)	90°	
Blocken, et al. (2009) [CFD study]	$h_c = 10.2V_{loc}^{0.93}$	(17)	0°	1 m
	$h_c = 9.2V_{loc}^{0.82}$	(18)	45°	
	$h_c = 7.7V_{loc}^{0.77}$	(19)	90°	

**Table 2: Wind directions used for experiments**

Descriptor	Direction relative to the solar-wall	Cardinal direction
0° wind	Perpendicular	S32°W
45° wind	Oblique at 45° with normal	S13°E
90° wind	Parallel	N52°W

**Table 3: Error in surface-averaged CHTC in using uniform wind speed distribution assumption as compared to the results for actual directional distributions**

Descriptor	Case 1: With surroundings		Case 2: Without surroundings	
	1 m/s	3 m/s	1 m/s	3 m/s
0° wind	13%	19%	34%	53%
45° wind	-10%	-19%	0%	-7%
90° wind	16%	11%	4%	-3%

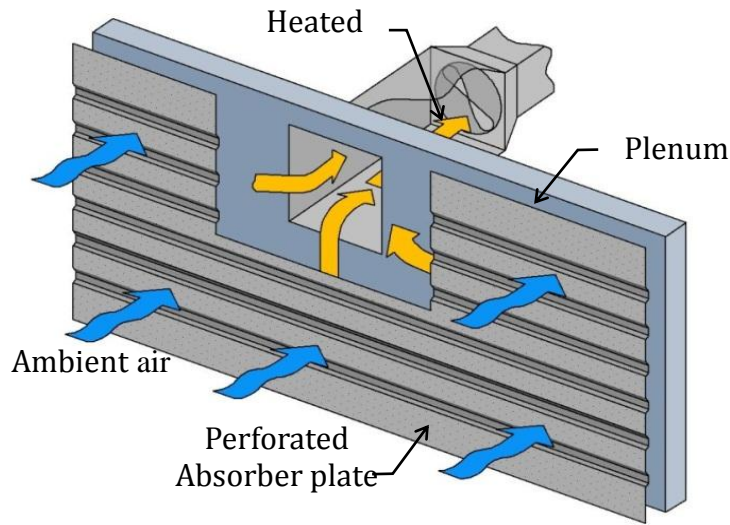

**Table 4: Error in overall heat exchange effectiveness due to uniform wind speed distribution assumption as compared to the results for actual directional distributions**

Descriptor	Case 1: With surroundings		Case 2: Without surroundings	
	1 m/s	3 m/s	1 m/s	3 m/s
0° wind	7%	6%	15%	12%
45° wind	21%	17%	24%	19%
90° wind	50%	43%	54%	48%

**Table 5: Error in thermal efficiency due to uniform wind speed distribution assumption as compared to the results for actual directional distributions**

Descriptor	Case 1: With surroundings		Case 2: Without surroundings	
	1 m/s	3 m/s	1 m/s	3 m/s
0° wind	-5%	-11%	-11%	-22%
45° wind	4%	13%	0%	4%
90° wind	-6%	-6%	-2%	2%



**Figure 1: Schematic of a UTC**

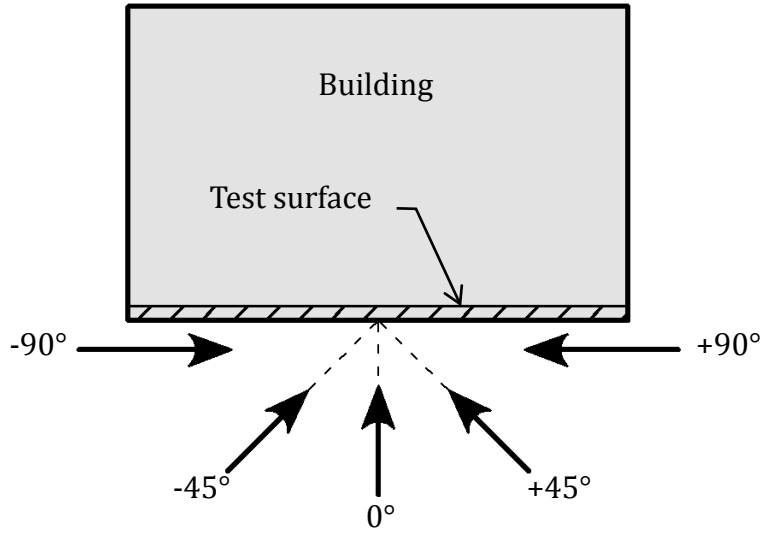

**Figure 2: Illustration of wind direction notation**

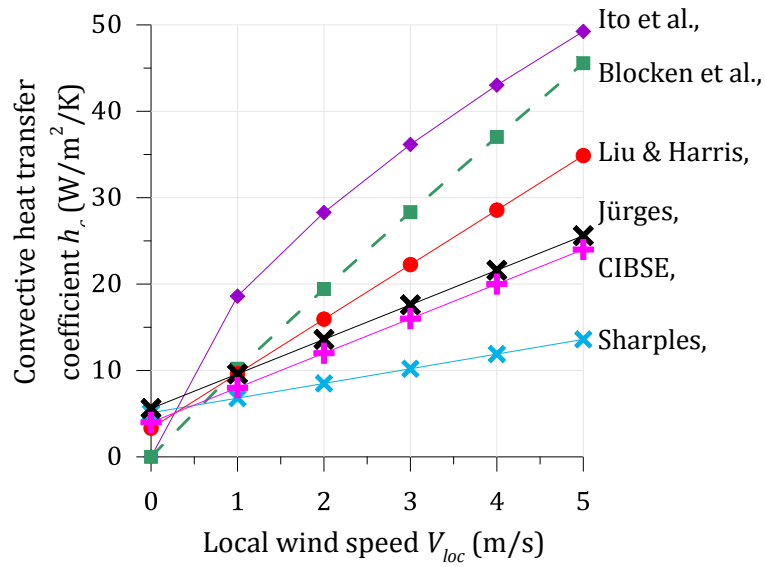

**Figure 3: Comparison of CHTC- $V_{loc}$  correlations from cited works for 0° wind on windward wall**

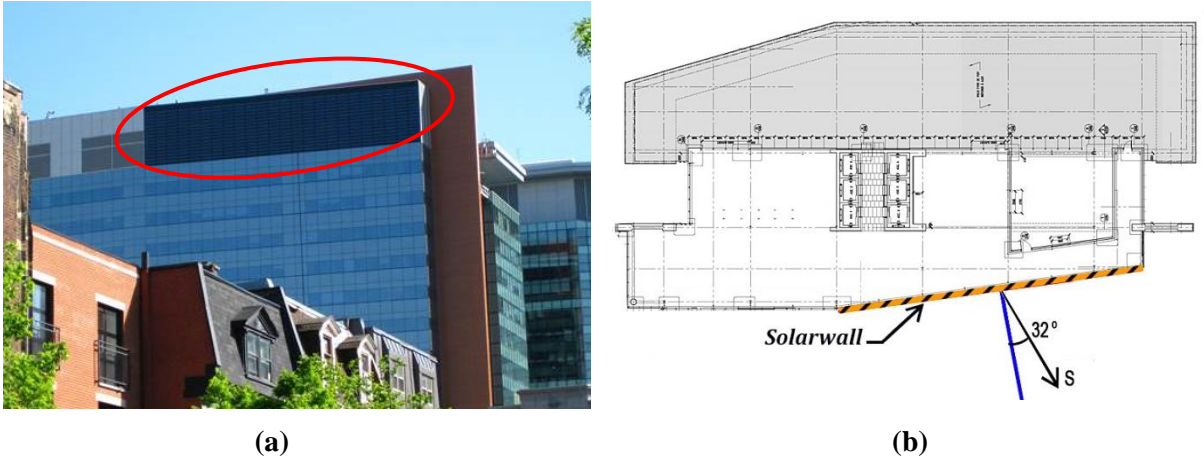

**Figure 4: (a) The JMSB building showing the location of the BIPV/T wall  
(b) Schematic plan of the JMSB building showing orientation and BIPV/T location**

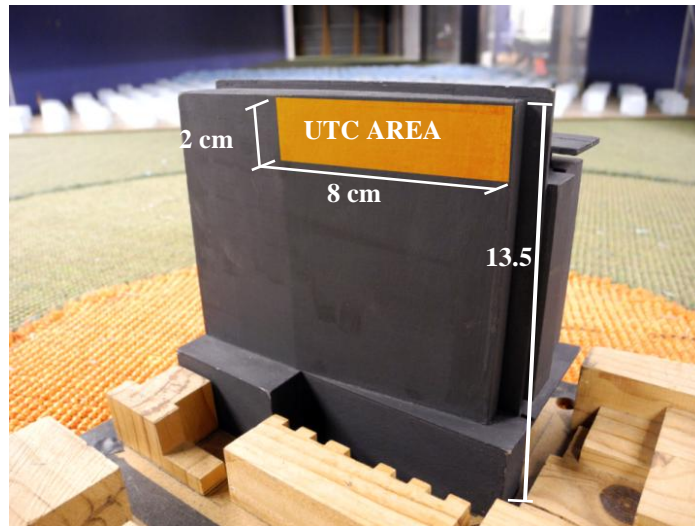

**Figure 5: Test area on the JMSB building model at 1:400 scale**

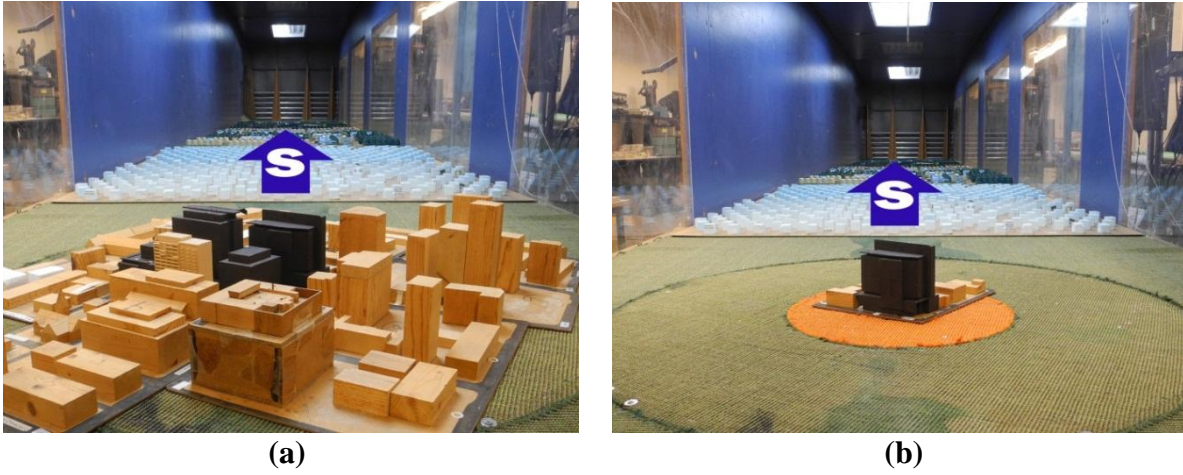

**Figure 6: Test wind direction - 45° (a) Case 1: Test building with all existing surroundings (b) Case 2: Test building in the absence of immediate surroundings**

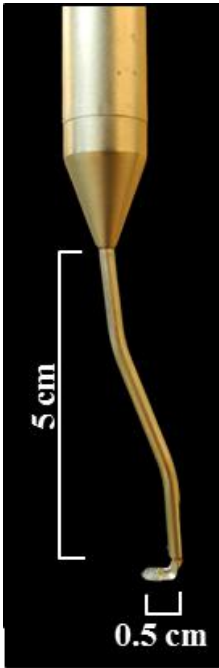

**Figure 7: Cobra Probe used for velocity measurements in the wind tunnel**

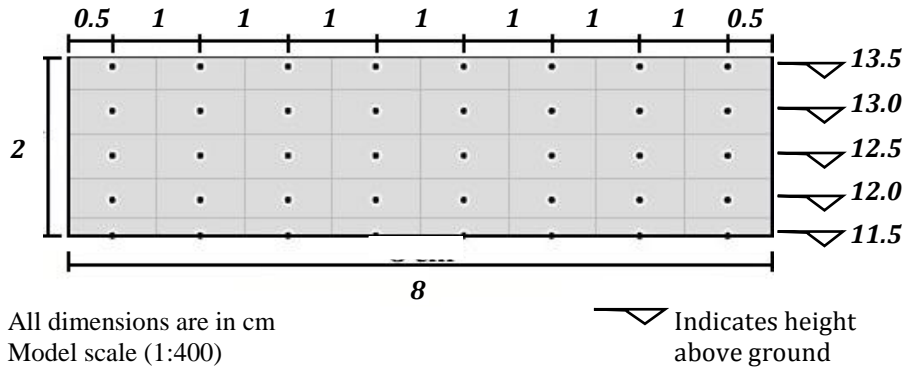

**Figure 8: Schematic of the test area showing velocity measurement points**

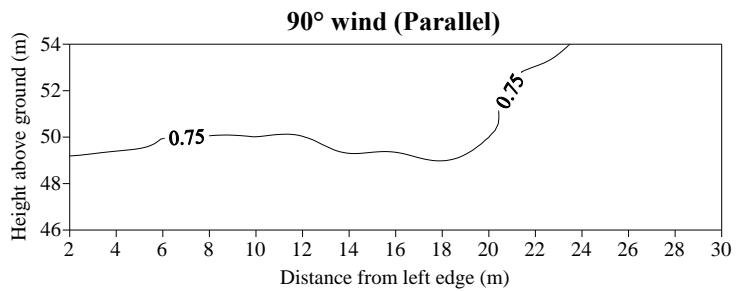
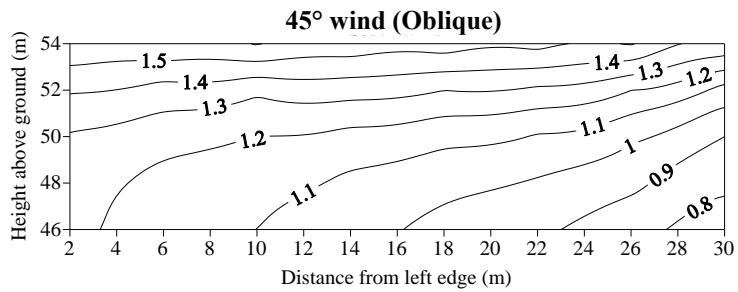
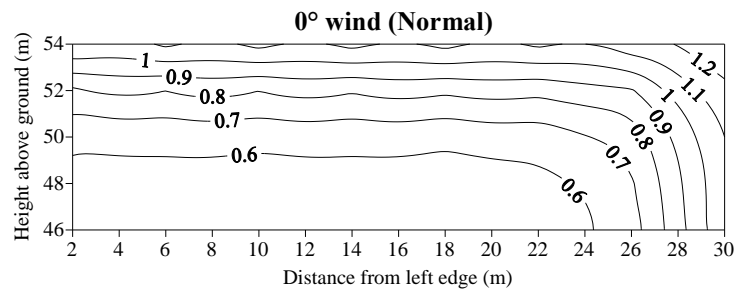

(a) Case 1: With surroundings

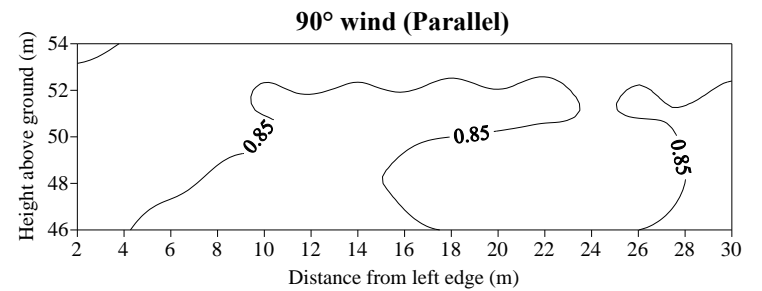
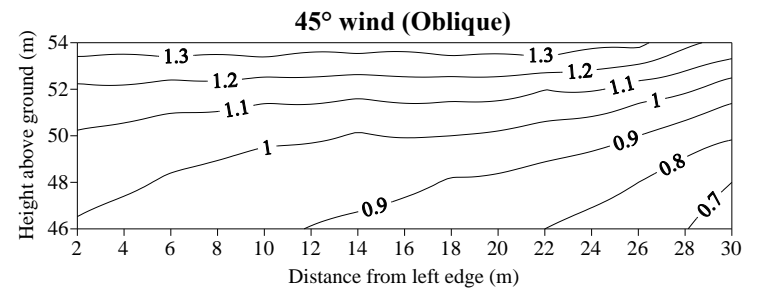
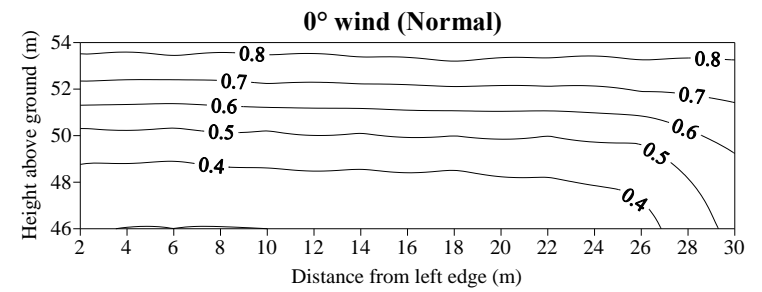

(b) Case 2: Without surroundings

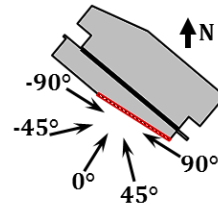
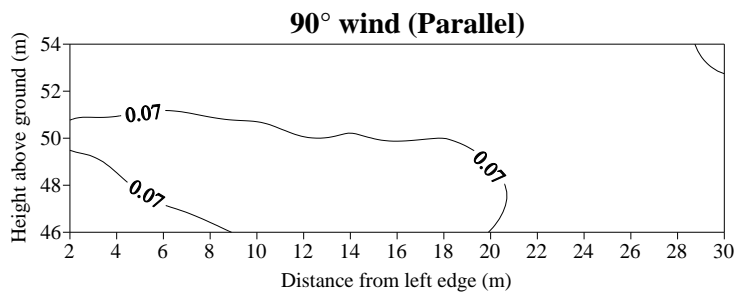
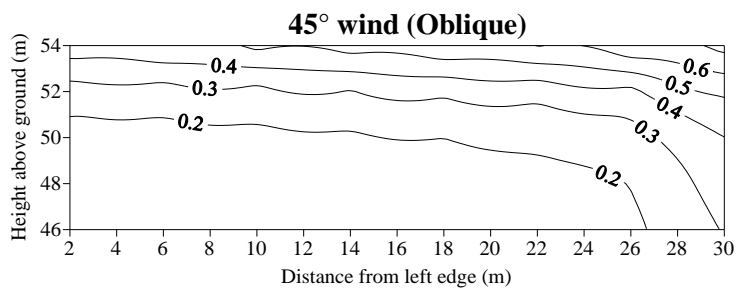
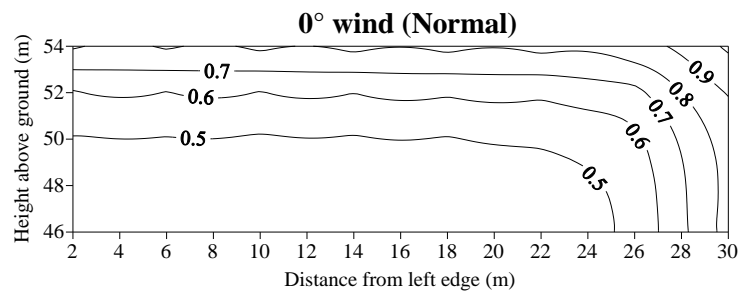
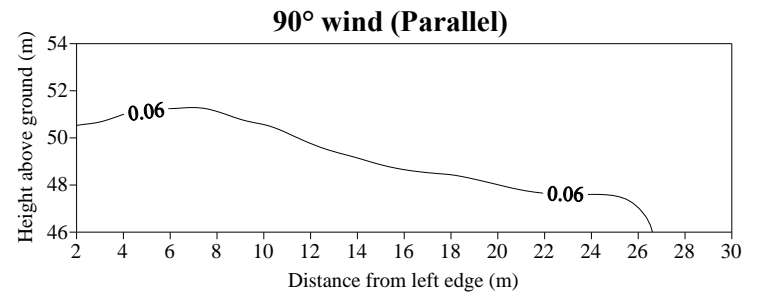
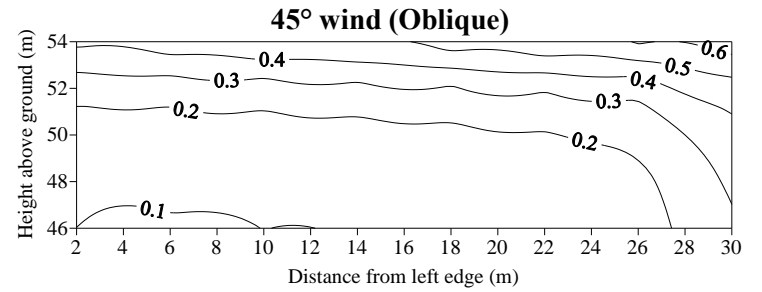
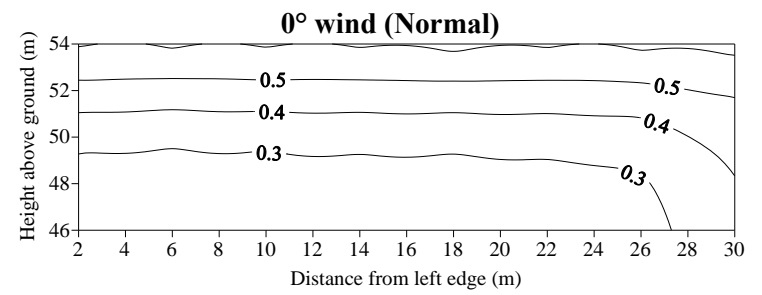

Figure 9: Distribution of local velocity coefficients  $[V_{loc}/V_{ref}]$  over the UTC area



(a) Case 1: With surroundings



(b) Case 2: Without surroundings

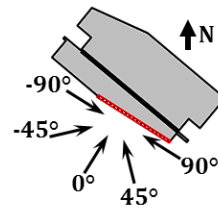
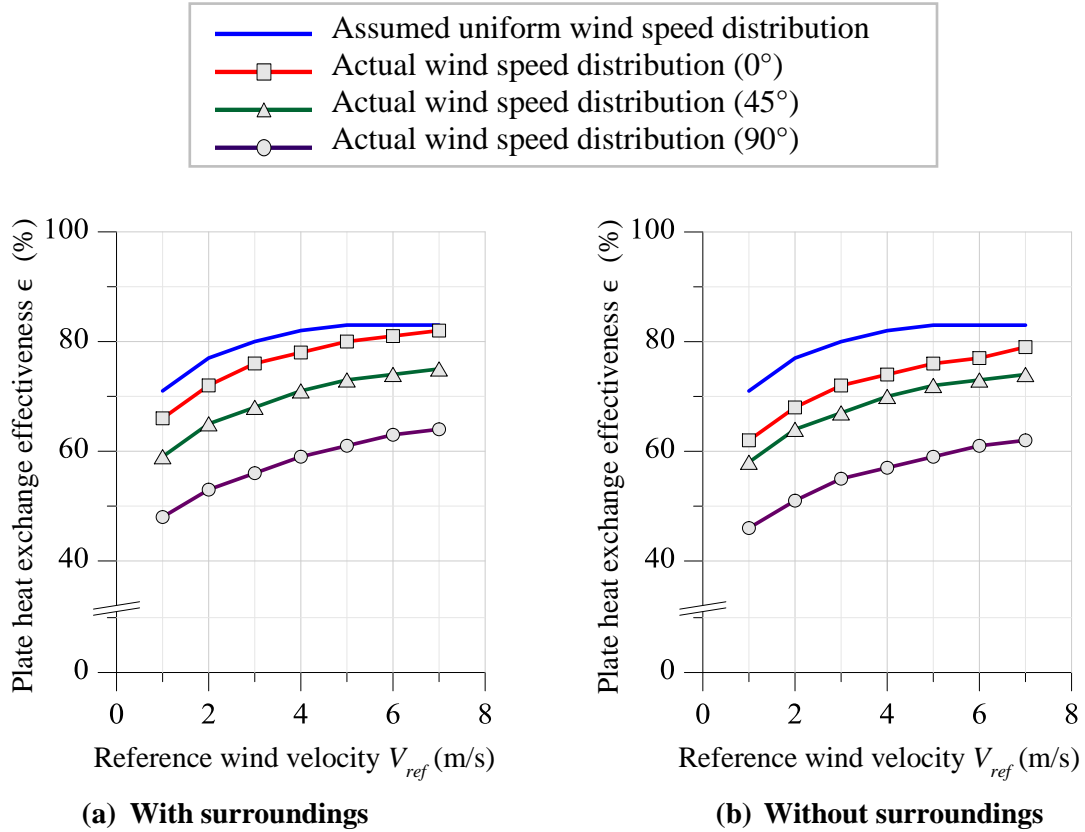
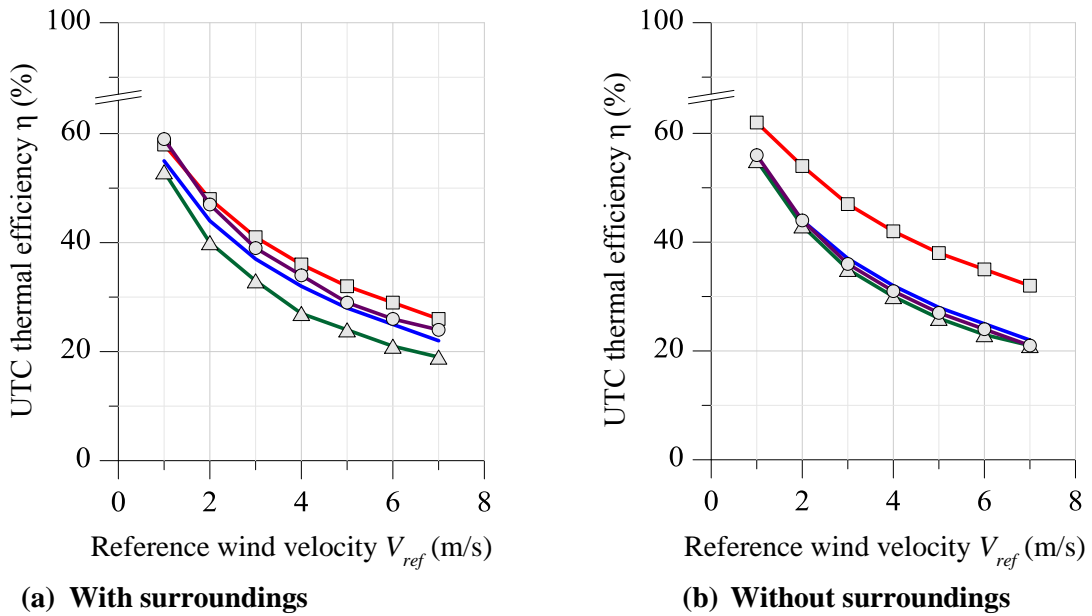

Figure 10: Distribution of normal velocity coefficients  $[V_{normal}/V_{ref}]$  over the UTC area



**Figure 11: Comparison of heat exchange effectiveness for different reference wind speeds and directions**



**Figure 12: Comparison of thermal efficiency for different reference wind speeds and directions**

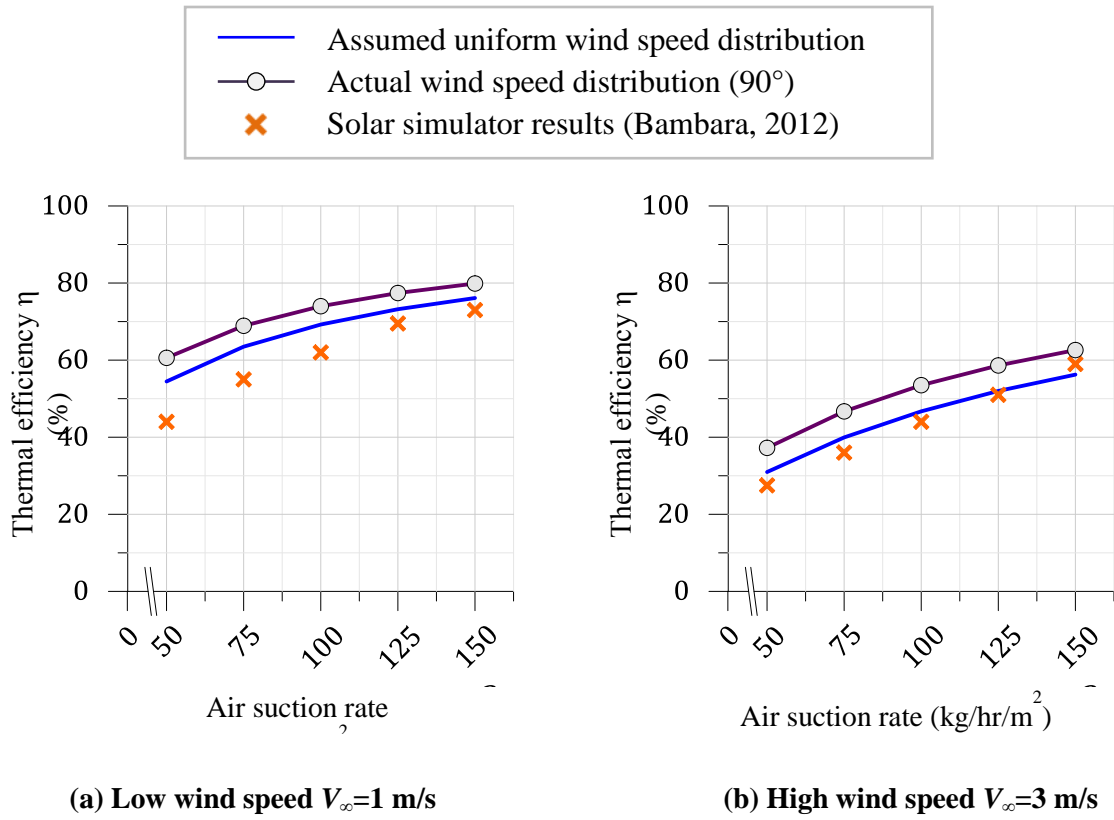

**Figure 13: Comparison of thermal efficiency with solar simulator results for parallel wind**