

Immersive Learning environments in the context of Knowledge Creation

Li Shang Ly

A Thesis

In

The John Molson School of Business

Presented in Partial Fulfillment of the Requirements

For the Degree of

Doctor of Philosophy (Business Administration) at

Concordia University

Montreal, Quebec, Canada

March 2018

© Li Shang Ly, 2018

CONCORDIA UNIVERSITY

School of Graduate Studies

This is to certify that the thesis prepared

By: Li Shang Ly

Entitled: Immersive Learning environments in the context of Knowledge Creation

and submitted in partial fulfillment of the requirements for the degree of

Doctor of Philosophy (Business Administration)

Complies with the regulations of the University and meets the accepted standards with respect to originality and quality.

Signed by the final Examining Committee:

_____	Chair
Dr. Mehdi Farashashi	
_____	External Examiner
Dr. Lynn Jeffrey	
_____	External to Program
Dr. Robert Cassidy	
_____	Examiner
Dr. Dennis Kira	
_____	Examiner
Dr. Mark-Alexandre Tomiuk	
_____	Thesis Supervisor
Dr. Raafat George Saade	

Approved by _____
Dr. Kathleen Boies, Graduate Program Director

March 26th, 2018

Dr. Anne-Marie Croteau, Dean, John Molson School of Business

ABSTRACT

Immersive Learning environments in the context of Knowledge Creation

Li Shang Ly, PhD

Concordia University, 2018

This dissertation redefines an immersive environment as a place where students become fully engaged and experience the state of flow. We argue that current research in immersive learning lacks focus on knowledge acquisition. Therefore, across 4 exploration papers, 9 experiments in a spectrum of university courses, we developed the Integrated Knowledge Acquisition Model (IKAM), a toolset allowing researchers to create learning tools with immersive elements. IKAM builds on 4 levels of pedagogical strategy starting with the capabilities of the tool (student-artefact-task) inspired by PAT, executed in a 3 phase form (create-evaluate-perform, with the mechanism of Nonaka's SECI Model), addressed with learning goals and measured by traditional performance scores.

Furthermore, we combined TAM, UTAUT, Cognitive Absorption model to build an immersive environment appropriate measurement model called the Technology Immersive Model (TIM). This scale was reduced through Exploratory Factor Analysis and Confirmatory Factor Analysis to a 15 items measuring the levels of enjoyment, immersion and timelessness of a student's experience in our immersive platform. Through Structural Equation Modeling we were able to determine and confirm that tool design (functionality and cognitive expectancy) engages students with intrinsic motivation which leads to immersion and timelessness. Overall, we contribute to the field of business technology management by providing a starting point to identifying immersion learning tool with a focus on knowledge acquisition in today's changing world embedded in technology and data.

DEDICATIONS

This is dedicated to my mother, my best friend Lam Tieu Binh

ACKNOWLEDGMENTS

I would like to thank Dr. Fassil Nebebe, Dr. Tak Mak, Dr. Danielle Morin, Dr. Raafat Saade, Ms. Eva Ferrera, Ms. Christabell Moyo, Prof. Mahesh Sharma, Dr. Dennis Kira for their continuous support in my career in the SCBTM department since the very beginning when I worked as a Teaching Assistant in 2010.

A very special thank you to my supervisor Dr. Raafat Saade, you protected me, mentored me through every step of the way and taught me many lessons that will shape me into a researcher and an academic.

A special thank you to my committee members and examiners Dr. Robert Cassidy, Dr. Lynn Jeffrey, Dr. Dennis Kira, Dr. Mark Alexandre Tomiuk who dedicated their time to review my dissertation and provide me feedback to improve my research.

I would like to thank my family, my mother Lam Tieu Binh, my brother Ka Vinh Ly, my fiancé Stephen Athanasoulis and our close family Barbara Papakostas, Dino Athanasoulis, Tina Athanasoulis, Richard Tang for their continuous support and investment in me. Thank you for taking care of me through very stressful times.

I would like to thank my colleagues in the Ph.D Program (Sonal Kumar, Megan Pepe, Pedram Fardnia, Moayad Tanash, Chun Zhang, Brad Aeon, Arka Mukherjee) for their genuine support and encouragements throughout the program.

I would like to thank all of my amazing friends from different places and my growing family for their support and encouragements in everything I do.

CONTRIBUTION OF AUTHORS

Dr Raafat Saade as my supervisor and co-author

Dr. Marc Alexandre Tomiuk

Dr. Danielle Morin

Dr Denis Kira

TABLE OF CONTENTS

LIST OF TABLES	X
LIST OF FIGURES.....	XII
CHAPTER ONE: INTRODUCTION	1
1.1 RESEARCH IN THE PAST 10 YEARS	2
1.2 THE FUTURE OF EDUCATION AND ITS HURDLES WITH TECHNOLOGY.....	9
1.3 CONTRIBUTIONS.....	17
1.4 STRUCTURE OF DISSERTATION.....	19
CHAPTER TWO: LITERATURE REVIEW	21
2.1 KNOWLEDGE MANAGEMENT	21
2.2 IMMERSIVE LEARNING	25
2.3 FLOW AND ENGAGEMENT	33
2.4 CONCLUSION.....	36
CHAPTER THREE: THEORETICAL FRAMEWORK	38
3.1 RECENT STUDIES.....	38
3.2 FLOW	43
3.3 KNOWLEDGE PROCESSING: THE SOCIALIZATION-EXTERNALIZATION-COLLABORATION- INTERNALIZATION MODEL.....	44
3.4 INTEGRATED KNOWLEDGE ACQUISITION MODEL	46
3.5 RESEARCH QUESTIONS.....	48
CHAPTER FOUR: METHODOLOGY	50
4.1 CONTEXT	50
4.2 THE COMPUTER ASSISTED LEARNING TOOL	51

4.3 THE INSTRUMENT	67
CHAPTER FIVE: EXPLORATORY RESEARCH	70
PAPER 1 –IMMERSIVE LEARNING EXPERIENCE	72
PAPER 2 –UNDERSTANDING OF PEER TO PEER LEARNING USING ITEM RESPONSE THEORY	74
PAPER 3 –EVIDENCE BASED MANAGEMENT FOR LEARNING: AN EXPERIMENT	76
PAPER 4 –KNOWLEDGE MANAGEMENT IT TOOL: AN INVESTIGATION WITHIN A MARKETING INTRODUCTORY COURSE	78
CHAPTER SIX: RESULTS & ANALYSIS	80
6.1 PSYCHOMETRIC PROPERTIES	81
6.2 DESCRIPTIVE STATISTICS	81
6.3 STATISTICAL ANALYSIS (EFA, CFA, SEM).....	85
PART 1 – EXPLORING OUR DATA THROUGH EXPLORATORY FACTOR ANALYSIS (EFA)	86
PART 2 – CONFIRMATORY FACTOR ANALYSIS (CFA).....	100
PART 3 – STRUCTURAL EQUATION MODELING (SEM) – MODEL TESTING	107
CHAPTER SEVEN: CONCLUSION	112
7.1 KEY FINDINGS.....	112
7.2 OVERVIEW OF OUR STUDY	113
7.3 PUTTING IT ALL TOGETHER (A RESEARCH ROADMAP)	115
7.4 LIMITATIONS	117
7.5 FUTURE RESEARCH	118
7.6 IMPLICATIONS	119
7.7 FINAL REMARKS	121

REFERENCES	122
APPENDIX A CONSENT FORM	143
APPENDIX B QUESTIONNAIRE.....	144
APPENDIX C ETHICS CERTIFICATE.....	146
APPENDIX D PAPER 1	147
APPENDIX E PAPER 2.....	180
APPENDIX F PAPER 3	224
APPENDIX G PAPER 4	251
APPENDIX H CHAPTER 6 PART 1 EFA	272
APPENDIX I CHAPTER 6 PART 2 CFA	273
APPENDIX J CHAPTER 6 PART 3 SEM.....	275

LIST OF TABLES

TABLE 1. 1 RESEARCH FIELDS OF INTEREST (NUMBER OF ARTICLES PER YEAR)	4
TABLE 1. 2 WORD COUNT SUMMARY TABLE OF 251 ARTICLES IN 2016.....	7
TABLE 3. 1 INTERSECTION BETWEEN STUDENT AND TASK- ARTIFACT INTERSECTION.....	42
TABLE 4. 1 LIST OF FEATURES WITHIN THE P2P SYSTEM.....	53
TABLE 4. 2 SUMMARY OF THEORETICAL LEARNING METHODS WITH TRADITION IMPLICATIONS AND GOALS	54
TABLE 4. 3 SUMMARY OF THE P2P PLATFORM INTEGRATION.....	60
TABLE 4. 4 INSTRUMENT WITH SOURCES OF ITEMS.....	67
TABLE 4. 5 MAIN AUTHORS AND THEIR CONTRIBUTIONS IN THE MODEL	69
TABLE 6. 1 LIST OF COURSES FROM OUR SAMPLE OF 288 PARTICIPANTS	82
TABLE 6. 2 REPRESENTATION OF THE GENDER SPLIT FEMALE (1), MALE (2)	83
TABLE 6.3 FREQUENCY TABLE FOR EACH EDUCATION LEVEL.	84
TABLE 6. 4 THREE-PART ANALYSIS PROCESS OF THE SCALE.....	86
TABLE 6.5 DESCRIPTION OF SCALE ITEMS USED IN THE STUDY AND THEIR SOURCES	86
TABLE 6.6 FIRST ITERATION OF EFA	90
TABLE 6. 7 JUSTIFICATION OF ITEM REDUCTIONS.....	92
TABLE 6.8 PARTIAL ITEMS.....	93
TABLE 6. 9 FINAL FACTOR LOADING	94
TABLE 6. 10 FINAL FACTOR LOADING - PARTIAL CORRELATIONS	95
TABLE 6. 11 FACTOR CORRELATION MATRIX.....	95
TABLE 6. 12 PARTIAL SCALE	97
TABLE 6. 13 FULL LIST OF SCALES AFTER FACTOR REDUCTION	99

TABLE 6. 14 SUMMARY OF COVARIANCES BETWEEN CONSTRUCTS	101
TABLE 6. 15 SUMMARY OF CORRELATIONS BETWEEN CONSTRUCTS	102
TABLE 6. 16 SUMMARY OF HYPOTHESES RESULTS OF OUR ANALYSIS	110
TABLE 6 . 17 SUMMARY OF HYPOTHESES RESULTS SPLIT BY GENDER OF OUR ANALYSIS .	111

LIST OF FIGURES

FIGURE 1. 1 OVERALL TREND OF RESEARCH PUBLICATIONS (ALL)	5
FIGURE 1. 2 OVERALL TREND OF RESEARCH PUBLICATIONS (CPAL, IM, CPALKM, IMKM)	5
FIGURE 1. 3 OVERALL TREND OF RESEARCH PUBLICATIONS (IM, CPALKM, IMKM).....	6
FIGURE 1. 4 WORD CLOUD REPRESENTATION OF 251 ARTICLES IN 2016.....	8
FIGURE 3. 1 STAGES OF FLOW AND THE PERSON-ARTEFACT-TASK MODEL OF FLOW ANTECEDENTS FROM FINNERAN & ZHANG (2003)	41
FIGURE 3. 2 MODIFIED TO STUDENT-TASK-ARTIFACT WITH EMBEDDED THEORIES	41
FIGURE 3. 3 CSIKSZENTMIHALYI (1990)'S FLOW DIAGRAM	43
FIGURE 3. 4 MODIFIED FLOW GRAPH WITH DIFFICULTY AND KNOWLEDGE	44
FIGURE 3. 5 SECI MODEL PROPOSED BY NONAKA ET AL. (2000)	45
FIGURE 3. 6 ENHANCED SECI MODEL INCLUDING 3 PHASES.....	46
FIGURE 3. 7 IKAM INTEGRATED KNOWLEDGE ACQUISITION MODEL	47
FIGURE 6. 1 GRAPH REPRESENTING THE DIVERSITY IN ETHNICITY OF OUR SAMPLE	83
FIGURE 6. 3 BAR CHART REPRESENTING THE LEVEL OF EDUCATION OF EACH COURSE.	84
FIGURE 6. 4 CFA MODEL OF 5 CONSTRUCTS.....	101
FIGURE 6. 5 FLOW OF CONSTRUCTS BASED ON THEORY	104
FIGURE 6.6 TECHNOLOGY IMMERSIVE MODEL (TIM) WITH HYPOTHESES TO BE TESTED.	105
FIGURE 6. 7 FINAL MODEL AMOS OUTPUT	108
FIGURE 6. 8 TECHNOLOGY IMMERSIVE MODEL (TIM) WITH RESULTS	108
FIGURE 6. 9 GENDER SPLIT RESULTS FOR TIM.....	111

CHAPTER ONE: Introduction

The advent of Information Technology (IT) and its exponential use impacts education around the world at all levels. More specifically, students' learning styles are continuously changing therefore affecting traditional teaching and establishing pedagogical models by evolving the basic unidirectional teacher-to-student instruction into a highly dynamic IT-supported and elaborated learning environment.

New learning environments entail three-dimensional graphics, computer games, animations and a full range of wide spread mobile devices of variable sizes fitting all demographics and contexts. The world of education has innovated throughout the globe to facilitate learning in multiple forms (Herrera, Guerrero, & Urbano, 2018; Ştefan, 2012b; Villagrasa, Fonseca, Redondo, & Duran, 2014).

Rooted in the traditional classroom style(s), educators are expected and encouraged to continuously seek teaching and learning improvements to engage students. Especially at the university level today, non-interactive learning seems to dominate students' classroom experiences despite the relevance in preparing a generation of future leaders to hop onto a heavily IT focused industry.

Given IT's potential to enhance learning through various innovative methods, we respond by centering this dissertation's scope around the concept of immersive learning and it's fundamental elements contributing to cognitive absorption.

Immersive learning environments have been a popular domain of exploration in the literature. However, there are debates around the notion that not all immersive environments are created for learning (Algarawi, Alslamah, Alhabib, Alfheid, &

Ibrahim, 2018; Christopoulos, Conrad, & Shukla, 2018; Pena-Rios, Callaghan, & Gardner, 2018; Quintana & Aranguiz, 2018).

Researches are focusing on the improvements of tactile skills and virtual reality graphics, while there is a lack of focus on the topics of knowledge acquisition and processing to which we believe is an essential variable to improve learning. With this in mind, we emphasize and investigate on existing knowledge management and knowledge acquisition models in combination to what is deemed as a justified immersive environment conducive to learning (Anderson, Spiro, & Montague, 2017; Bolisani & Bratianu, 2018; Finneran & Zhang, 2003; Jackson & Marsh, 1996; R. Saadé & Bahli, 2004; Sein-Echaluce, Fidalgo-Blanco, & García-Peñalvo, 2017; Van Schaik, Martin, & Vallance, 2012).

We propose a three-fold theoretical framework consisting of student-artefact-mechanism, a model tying together qualitative and quantitative analyses through eight experiments and four written papers as well as an in-house immersive learning tool.

1.1 Research in the past 10 years

In the present chapter, we will highlight the current field of research in the past 10 years and examine the popularity and fluctuations of academic publications in the domains of computer-assisted learning (CPAL), immersive learning (IM), and knowledge management (KM). We then further a discussion on the current hurdles in technology and the shift of society in education from a teacher, students and administrators' perspective.

Through a web search, we present an aggregation of publications of five key words such as computer assisted learning (CPAL), immersive learning (IM), knowledge management (KM), as well as the combination of two domains such as computer assisted

learning – knowledge management (CPALKM), immersive learning – knowledge management (IMKM).

The topic of knowledge management has been highly popular in academic research, especially from 2007-2014. In the last 10 years, experiments and empirical research on this topic has grown, then plateaued in 2011. We noticed a rising peak followed by a quick run to maturity. It seems that researchers studied the area of knowledge management in the world of business and organization in the hopes to manage the knowledge of employees and staff members. The topic became popular due to the practice of reassessing techniques and methods for better management of knowledge and knowledge transfer within an organization, especially when it came to succession planning, noting that at that time there was a large increase in retirements (See Table 1.1). Interestingly, a dip brought down the interest of this discipline reaching a high of 62300 articles to 35900 articles in 2016.

Table 1. 1 Research Fields of interest (Number of articles per year)

Year	Computer Assisted Learning (CPAL)	Immersive Learning (IML)	Computer Assisted Learning & Knowledge Management	Immersive Learning & Knowledge Management	Knowledge Management
2006	2270	105	144	6	38300
2007	2680	185	165	14	43600
2008	2970	330	208	23	51000
2009	3350	398	230	28	53300
2010	3760	535	278	45	56800
2011	4330	556	307	45	62300
2012	5070	708	397	52	56600
2013	5330	720	398	58	58400
2014	5740	709	443	50	49400
2015	5880	731	409	55	40800
2016	5640	756	414	55	35900
2017	4650	792	393	65	28000
APY	4306	544	316	41	47867
$\Delta 5$	-146.000	-0.051	-0.366	-0.250	-1087.459
$\Delta 10$	280.242	0.138	0.506	0.136	-374.064

APY: Average Per Year

D5: Change in last 5 years (Slope)

D10: Change in last 10 years (Slope)

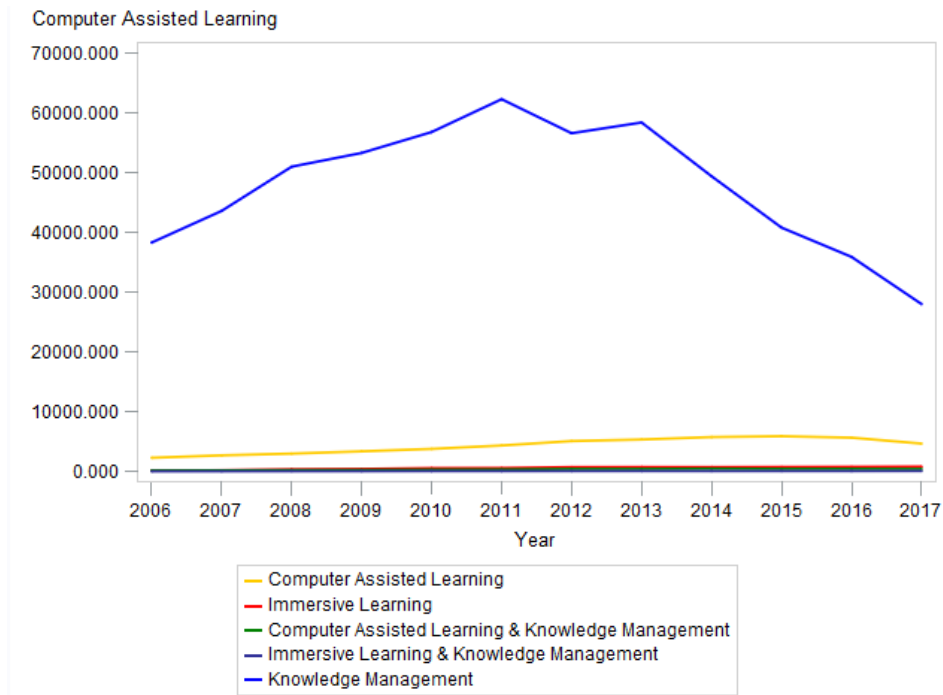

Figure 1. 1 Overall trend of research publications (All)

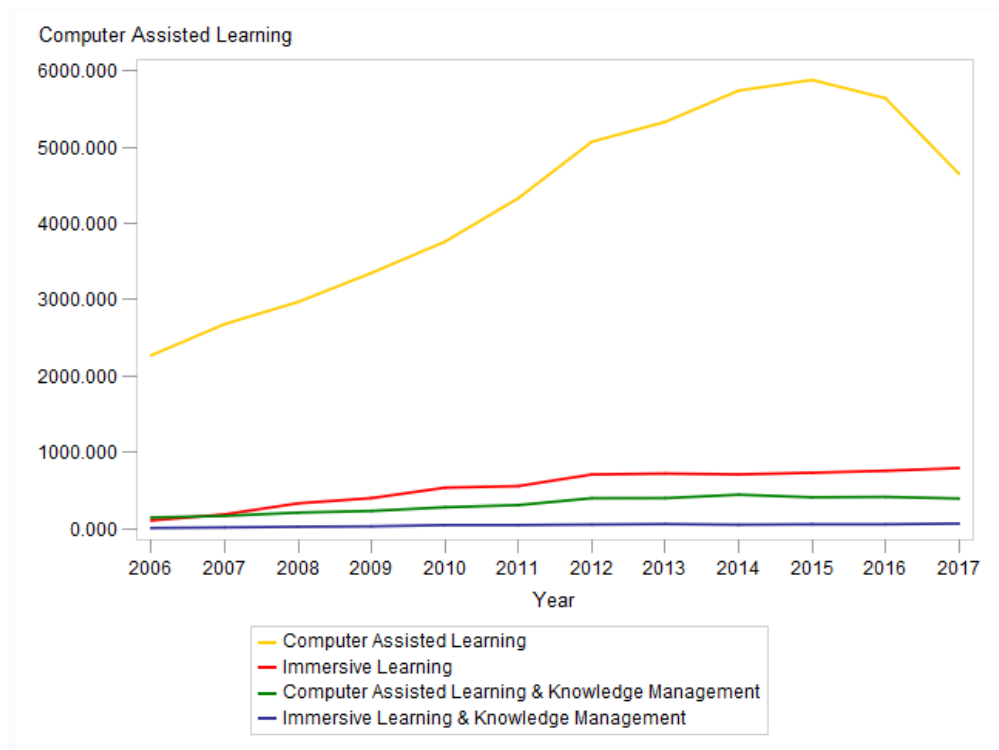

Figure 1. 2 Overall trend of research publications (CPAL, IM, CPALKM, IMKM)

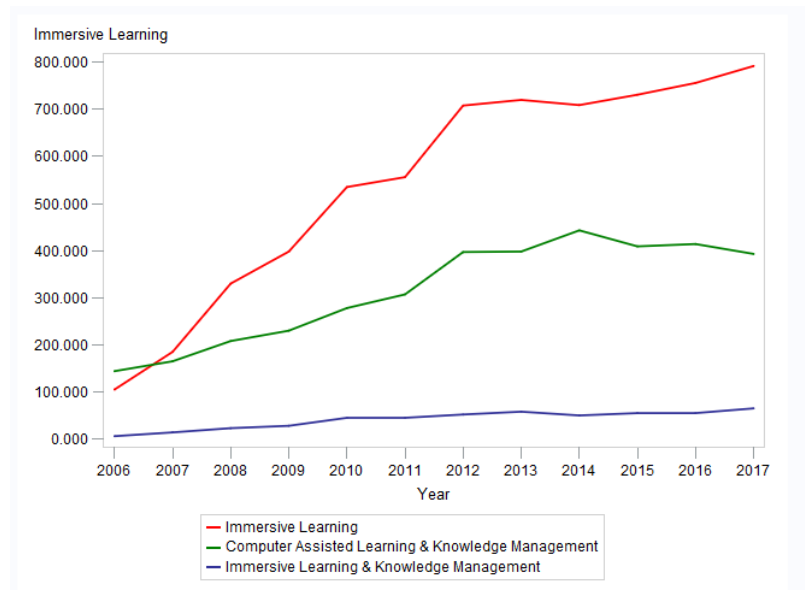

Figure 1. 3 Overall trend of research publications (IM, CPALKM, IMKM)

On the other hand, the topic of computer-assisted learning has been on the rise in the past 10 years and has not yet reached a plateau of interest. The first interest in CPAL started with Randall & Ruddell (1946) studying adult literacy and further raised to 5 papers in 1948 on topics in computer assisted teaching and learning.

When we combine the search of articles in both fields (CPALKM), we see a rise in interest in the relevance of technology input and the need to reorganize larger formats of information such as data, statistics and archives. The combination of both domains generated an increase in scholarly publications from 144 articles in 2006 to 414 in 2016, and it continues to rise up to today.

As for the topic of immersive learning (reaching an average publication of 741.6 articles in the last 5 years), although the body of knowledge and research output is not as strong as CPAL (5448 average articles in the last 5 years) is gaining momentum and popularity over the past decade. The number of publications grew 7-fold in the last 10 years from 105 articles in 2006 to 756 articles in 2016. Upon an investigation of the 756

articles, we observed the majority of research in immersive learning take primarily an educational and instructional perspective through virtual reality, whereas the key word “Knowledge” and “Cognitive Absorption” was only mentioned 1 time. See Figure 1.4 for the word cloud representation of the articles as well as their word count in Table 1.2. However, articles with the combination of both immersive learning and knowledge management (IMKM) are scarce.

Table 1. 2 Word count summary table of 251 articles in 2016

Word Count	Word	Word Count	Word	Word Count	Word	Word Count	Word
164	Learning	6	Exploring	4	Collaborative	4	Design
87	Immersive	6	Teaching	4	interactive	4	gaming
57	Virtual	6	approach	4	integrating	4	skills
21	education	6	Online	4	development	4	focus
52	Environments	6	higher	4	Integrating	4	model
25	Reality	6	based	4	engagement	4	mixed
23	Experience	6	Using	4	strategies	4	Tool
9	Designing	5	collaborative	4	Assessment	4	User
8	Educational	5	gamification	4	Challenges	4	New
8	Developing	5	Augmented	4	Game-based	3	Collaborations
16	Students	5	analytics	4	literature	3	mixed-reality
8	Second	5	Language	4	algorithms	3	professional
8	review	5	language	4	corporate	3	Experiential
16	Games	5	teaching	4	assessing	3	applications
8	study	5	students	4	computer	3	intelligent
8	Life	5	research	4	embodied	3	engineering
7	educational	5	English	4	Training	3	interaction
7	simulation	5	Network	4	Courses	3	exploration
7	technology	5	School	4	Digital	3	Development
7	training	5	worlds	4	digital	3	Interactive
7	Creating	5	future	4	Medical	3	simulations

7	Research	5	world	4	teacher	3	Exploratory
7	science	5	case	4	Impact	3	systematic
7	systems	5	STEM	4	System	3	e-learning
7	online	5	data	4	Skills	3	experiment

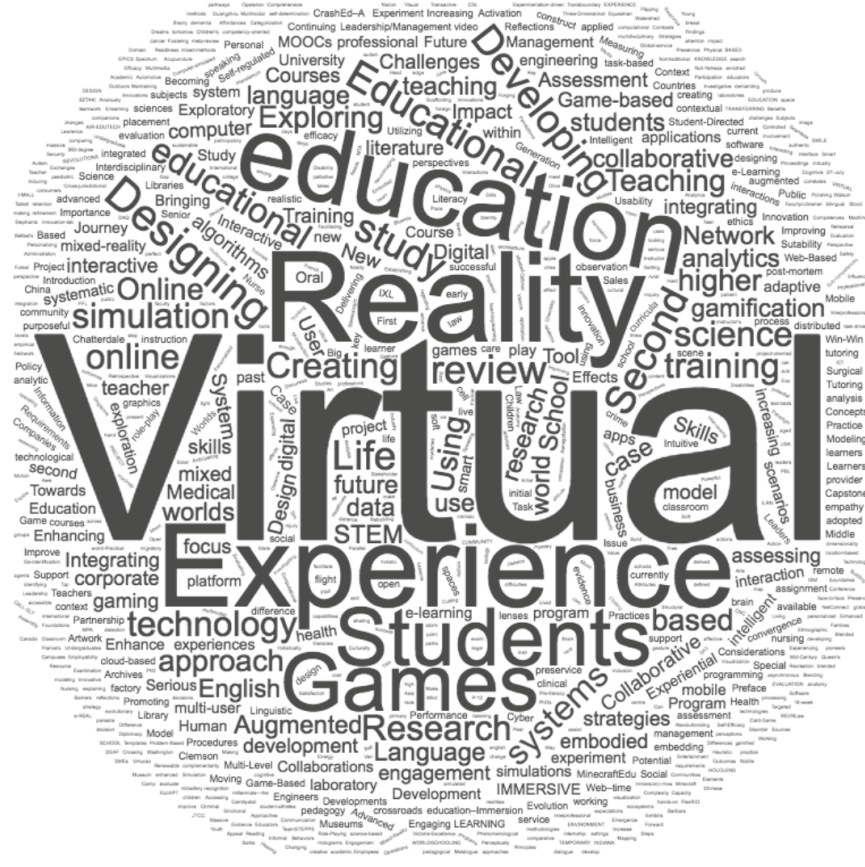

Figure 1. 4 Word Cloud representation of 251 articles in 2016.

In year 2000, the combination of IMKM did not exist in scholarly peer reviewed journals, they only appeared in 2006 with 6 articles rising to 55 articles in 2016. This begs the question on whether interest and subsequently research in the area of knowledge processing in immersive environments will rise? We strongly believe that we are at the onset of a paradigm shift where the foundations of immersive learning and of knowledge management will be fused within IT-based environments toward the betterment of

measurable learning objectives. We advocate in this dissertation the strong need for research in this domain.

The concept of utilizing computer assisted learning systems as a complement to the creation of immersive learning with designs of structural strategies to manage information and knowledge flows seems to be uninvestigated. Overall, there are many hurdles in adapting information technologies for learning. In the next section, we will discuss the factors that create resistance to technology and how we are on the road to overcome some of them. We will also mention how technology has taken a role in education and we foresee it to stay an important medium for the future.

1.2 The future of education and its hurdles with technology

Overall Resistance to technology

Originally, technology adoption has been strongly resisted by the school environment in general and higher education due to uncertainties in assessing the success and cost/benefit of the investment and commitment it requires. The value to the learning process was not clear or evident. Since 2001, according to Maslowski (2001) decisions to integrate and adopt IT into the education environment followed the school's culture, vision, norms and values that are shared with faculty members, staff members and students. As technology integration mediates teachers' actions, beliefs and attitudes mentions Chai, Hong, & Teo, (2009). In recent years, there seems to be a major shift in higher education towards the inclusion of IT in education, however the value proposition with regards to learning is still not clear, evident or established since the introduction of TAM (technology accepted model, a concept still investigated today (Schmitt & Saadé, 2017 (June); Teo & Zhou, 2017).

Doering, Hughes, and Huffman (2003) conducted a study where teachers were doubtful and very hesitant to using technology. Surprisingly after their completion of an initiation course, their doubts transformed into positive sentiments due to their better understanding of the support network available to them and the advantages of implementing a technology system. As a result, to this experiment, the school's pedagogical knowledge increased. This situation has been shown by multiple authors such as Choy, Wong, and Gao (2009), Fu (2013) in most recent years.

Doering, et al. (2003)'s study still applies today (although to a lesser extent) since senior faculty are still teaching today – a group whose majority is still resistant to the use of today's technologies. To ease adoption, Doering, et al. (2003)'s experiment shows teachers and students need to be exposed and trained to a new learning management system before they can see positives in a novelty. These activities, held to introduce the potential of modern information technologies in the classroom seem to have just started in higher education and are face with the challenge of sustainability and integration within the university culture.

The future in education and its opportunities

Mentioned in 2001 and evident today, Niederman and Rollier (2001) expressed the future may hold where universities offer multi-disciplinary programs with the partnership of other schools (Sincak et al., 2017). Institutions are brokers who provide facilities to their buyers and sellers in education services. Although organizations seem to be moving towards this direction, higher education seem to remain in their training model of program offering (Newman & Scurry, 2015).

Thus, institutions that do not initiate a change in their vision in adapting to an information technology, their future will cease to exist mentioned Reddy and PS Goodman (2002).

Glenn and D'Agostino (2008), noted that technology will change skill-sets required for the future workforce, while corporations and organizations have to consider the opportunities and threats in order to remain competitive in the market. This also applies to higher education institutions.

We stress the notion that IT is a major contributor to learning whereby knowledge (or subject matter) is processed in ways transcending traditional instructional methods and such that the role of the educator changes into a facilitator of this knowledge processing activity. The ultimate goal is to enhance the learners' engagement with the subject matter conducive to enhance efficiency and effectiveness.

In order to answer whether learners work more efficiently and effectively, we analyzed current research on IT in learning and explain which aspects of IT are advantageous (increases their effectiveness and efficiencies) and disadvantageous (decreases or does not change their performance) for learners. Along with this analysis, we can further investigate whether technology should be used in the educational and training context and if so, in which cases it would be most appropriate.

Going back to basics

In a study of information communication technology (ICT) in Uganda, researchers mentioned not to underestimate the power of local knowledge even if it does not happen between four walls in a school mentions Andena, Norton, and Kendrick (2010). In developing countries where technology is scarce, it allows people to reflect on

what is the most important when implementing technology. Andena, et al (2010) noted for technology to be effective for learning, the basics need to be met. Such basics entail an effort to understand and integrate local knowledge and local literacy practices, having interventions and focusing on allowing participants to be productive in their capabilities to develop skills and contribute to local knowledge and global discourses. In addition, for the programs to be culturally and ideologically sensitive to the local situation of each country. Mentioned in 2010, as well as in a series of articles in year 2017, Henderson, Selwyn, and Aston (2017) suggest that technology doesn't transform the nature of teaching and learning, but instead enabled diversity of provision, equal access and increased efficiency of delivery as well as the personalization of an individual's learning process.

Technology has the potential to transform the economies in the world including various educational systems available. It is important to emphasize on building participants 'capacity to generate knowledge rather than emphasizing on the mere transfer of digital literacy skills and tools available. Andena et al., (2010); Angus, Snyder, & Sutherland-Smith, (2004); Meyers, Erickson, & Small, (2013) mentioned the emphasis on the true reasons of a digital divide, which is the differences in culture, education, literacy, opportunity and social power.

Moreover, the access to technology is much more complex as it is a multi-level social goal and enriches those who get the benefits associated to these resources, therefore efforts should be made to explore ways through which technology can become a medium to transport communicate resources (such as stories and skills) to the

classroom and make such learning engaging and accessible to all (Comber and Green 1999; Burbules and Callister 2000; Andena, Norton, and Kendrick 2010).

Access to technology, a shift in society

Facer, Furlong, and Furlong 2010 mentioned the possibility of two future societies, either a modern information society or an underdeveloped society that did not bite the information bullet. Thus, children of the digital generation must be given access to information in order to become future working in the knowledge economy. In addition, authors Furneaux, (200) and Her, (2017) mentions technology will continue to gain a significant impact on higher education where technology will become the core differentiator in academic institutions. A statement mentioned by Glenn and D'Agostino (2008) still applies even more rapidly today whereby university research and development departments were once the primary arena for testing new tools and theories, while a shift has occurred where corporations are now the edge in adopting new innovations.

The convenience of technology

What can information technology offer? Information technology allows access to learning material 24 hours a day, 7 days a week. It created opportunities for asynchronous learning allowing students to learn at their own pace and style. (Hjørland, 2008; Mukherjee & Bleakney, 2017). Students with greater access to a wealth of information can refer to material, submit homework out of class anywhere with an internet access. An increased access influences the way students learn course material (Furneaux, 2004), on the flip side, technology can be disruptive to encourage cases of plagiarism, cheating,

distractions and confusions due to the amount of information available to them (Glenn & D'Agostino, 2008).

15 years ago, we witnessed the use of futuristic tools such as video podcasts, RFID sensor networks, mobile broadband, Wikis and Blogs. A few years later in 2008, online courses, text messaging, document management became popular tools (Glenn & D'Agostino, 2008). The variety year after year keeps growing such that today ipads, tablets have now become the new trends (Nguyen, Barton, & Nguyen, 2015). However, the same issue persists, people are still not readily prepared to be critical and evaluate the amount of information available unless they are the producers and consumers of the knowledge (Andena, et al. 2010).

Where does technology lead us to?

Academia in general accepts the opportunities associated with online courses, a key to advancing the institutions mission and giving access to advanced education (Scoppio & Luyt, 2017). Moreover, corporate academic partnerships increasingly become part of the university experience. To that effect, institutions have to demonstrate a commitment to advanced technologies in order to attract corporate partners. University faculty and staff view information technology as having a positive impact, however they acknowledge that there can be challenges such as tenure, promotions and other organizational practices that will need adjustments in order to encourage members to adopt new technologies. Institutions can allow their knowledge to be transferred to foreign locations, where distance education becomes increasingly global and the ability to reach more individuals around the world – a clearly attractive proposition. As Cornell University Ms. McClure mentions *“Today’s students are used to getting what they need*

instantly and universities have to respond to remain competitive, yet these innovations often cost millions of dollars.”, it is an issue of money (Glenn and D’Agostino 2008, p.6). Many faculty and staff mentioned that tenure and promotion requirements may need to be re-worked as they should include technology based teaching criteria (Glenn & D’Agostino, 2008).

Barriers to the use of IT in learning

Innovative practices in higher education such as the use of technology has created many barriers for students, teachers and administration. Soden (2017) argues, it is often not about the technology but the method of communication and feedback used. There needs to be a level of summary and formative engaged feedback. In his article he elaborates on the use of screen captures as a form of support to teach users how to use technologies, the author argues that the low priority and limited time given to educators to receive formative rather than summative assessment on the use of technology has an impact on university teachers’ motivation to innovate (Soden, 2017 p. 14).

Students’ perspective

From the students’ perspective, Frederick, Schweizer, & Lowe (2006) indicated technology creates a few challenges for students, especially those with mobility, special needs and anxiety issues when faced with standardized tests. Students in general experience a need to have technical skills, a reduction of peers and instructors interactions (Fu, 2013; Whelan, 2008). In addition, technology is disruptive and pervasive creating distractions to students’ attention. At the University of Illinois, Dr. Johnson from (Economist, 2008) noticed an increase in discourteous behavior such as plagiarism and cheating in courses that leverages the online environment.

“Perhaps due to the relative anonymity of that forum, students appear to take more liberties online than they would in class.”

Solidified by the argument of Glenn & D’Agostino (2008). The easy access to online reference material causes the greatest risk to education by new technologies. Mainly the access to online facts and research increases the risk that students are graduating without foundational knowledge in some subjects.

Teachers’ perspective

On the teachers’ perspective, Jo Shan Fu’s article (2013) as well as many authors have mention technology brings a lack of clear vision (Al-Bataineh, Anderson, Toledo, & Wellinski, 2008), Lack of assistance and knowledge support (Ertmer & Ottenbreit-Leftwich, 2010; Hutchison & Reinking, 2011; Tezci, 2011; Yildirim, 2007), lack of allocated time for the mastery (Almekhlafi & Almeqdadi, 2010; Tezci, 2011), lack of focus on the content of the course (Lim, 2007), pressure to increase performance (Liu & Szabo, 2009), insufficient skills for managing teaching materials (Frederick et al., 2006; Goktas, Yildirim, & Yildirim, 2009; Honan, 2008; Yildirim, 2007), lack of financial support (Liu & Szabo, 2009).

In turn authors suggest a few strategies to deal with these challenges such as providing training and developing activities that related technologies: Create support groups to encourage teachers to share their effective technology practices and experiences (Ertmer & Ottenbreit-Leftwich, 2010); offer opportunities for students to live through what it is like to use technology efficiently (Frederick et al., 2006); and integrate course curricula with technology-enhanced material.

Our motivation in this dissertation to explore the IT potential to enhance learning centering on the concept of immersive learning and its fundamental elements contributing to cognitive absorption also take into observations on current and past studies and hurdles on education and technology. In the next sections, we would like to present existing knowledge management models, mainly Nonaka, Toyama, and Konno (2000)'s work within an immersive learning context and the foundational concepts cognitive absorption such as the state of flow – full engagement.

1.3 Contributions

This dissertation contributes to the body of knowledge and the advancement of research at the intersection of several fields of interest namely, in knowledge management, computer assisted learning – e-learning/e-pedagogy, design, collaboration and immersive learning. We present the design of an e-tool, methodology and results of a study using this e-tool within the context of higher education students' level of e-learning technology adaption and their learning experiences (specifically the experience of flow) in classrooms at multiple levels (undergraduate, masters, doctoral).

We also contribute to a niche of interest in the integration of information technology in collaborative e-learning within a knowledge management framework and perspective as we look at structures and designs of knowledge created by people who assess their knowledge acquisition and processing level through the medium of the e-learning information technology.

Moreover, this dissertation contributes to computer assisted learning and information technology in education body of knowledge by showcasing a web-based information system that addresses the multi-disciplinary nature embodied by the

mechanics of learning. Even though it is one example of an information technology, our contribution allows educators and researchers to categorize types of ITs, designs and information and knowledge models in order to achieve a higher engagement level of learning.

With the rise of interest in immersive learning, this study puts into perspective immersive learning in today's highly interactive internet environments and the classroom thereby providing ideas and sharing information and guidance to researchers who develop information systems/technologies for learning with a focus on knowledge processing.

In specific, the present research elaborated in this dissertation contributes to the body of knowledge in the following ways:

1. Proposes a theoretical framework for collaborative e-learning;
2. Integrates knowledge management, flow, and collaboration theories into the conceptual model;
3. Maps and explores the elements of the theoretical framework in an e-collaboration tool across
4. Different educational levels
 - a. Undergraduate new entrants
 - b. Undergraduate at graduation
 - c. Masters
 - d. PhD
5. Different majors and subject matters
6. Studied Evidence-based versus non evidence-based
7. Utilized different statistical methods to understand learning (EFA, CFA, SEM, IRT)

Based on the contribution 3, the present study looks at the generalizability of the application within the theoretical framework; Testing of the theoretical framework based on validated survey items and performing further validation within the present context;

Reduces the theoretical constructs and re-interprets them in to the present context;
Develop a theoretical model: Technology Immersive Model (TIM).

1.4 Structure of Dissertation

This dissertation stems from the Person-Artifact-Technology (PAT) by Finneran & Zhang, (2003), which was used by a recent author Van Schaik et al., (2012) who argued when using technology, if a person achieved the state of flow, they are therefore immersed. Led by this thought, we began looking into the literature for identify further the relationships between immersion and attaining flow related to learning environments using technology. We looked into the literature review of three core topics in Chapter 2 mainly knowledge management such that a tool or process allow knowledge to be organized and knowledge to be transformed and acquired, immersive learning environment which has been a relatively popular topic of research, however we question to what level immersive learning truly deals with knowledge. And finally, flow of engagement, which is our measurement of higher learning engagement levels.

We follow by introducing in Chapter 3 our theoretical framework with which we center our research around by defining three elements:

1. Students' experience and knowledge gain, complemented by a task designed with Nonaka, Toyama, and Konno (2000)'s SECI model and the artefact , a new technology platform allowing all components to function.
2. Artefact, a peer to peer in house developed tool with which the pedagogical design and functionalities strategically followed the SECI model allowing students to process their knowledge and achieving an environment that is engaging to the flow state.

3. Task, a process allows students to transform their knowledge in a 3 steps process of creating, evaluating and performing, while allowing collaboration and the measurement of their engagement level through flow.

These three elements translate into an Integrative Knowledge Acquisition Model (IKAM) defines as the components necessary to develop an immersive e-learning tool. In Chapter 4, we break down the details of our methodology and measurement scales inspired by multiple authors and theoretical models such as Flow (Csikszentmihalyi & Csikszentmihalyi, 1992), Technology Acceptance Model (TAM) (F. D. Davis, 1989), Unified Theory of Acceptance and Use of Technology (UTAUT) (Venkatesh, Morris, Davis, & Davis, 2003), Motivational Model (MM) (F. D. Davis, Bagozzi, & Warshaw, 1992), Cognitive Absorption by (R. Saadé & Bahli, 2004). We also take the opportunity to showcase the peer-to-peer platform. In Chapter 5, we summarize and showcase 4 exploration papers from which we tailored our research design. These papers were presented in multiple conferences, proceedings and journals allowing us to receive feedback and comments to improve our research. To bring it all together, in Chapter 6, we take on an overview by exploring factors within our aggregated sample, confirm factors and investigate on relationships between constructs and propose the Technology Immersion Model (TIM) as a measurement of flow within an immersive learning environment. We then conclude in Chapter 7 our final thoughts on our research limitations, future research, contribution and applications.

CHAPTER TWO: Literature Review

The research work presented in this study is based on three theoretical foundations mainly knowledge management, immersive learning and the state of flow, to that effect, the literature review will follow as per the respective theoretical areas. We now review the body of knowledge of these three topics.

2.1 Knowledge Management

Current research (Chaves, Scornavacca, & Fowler, 2018; Foote & Halawi, 2018; Moen, Benum, & Gjørnum, 2018; Winkler & Wagner, 2018) in knowledge management have revised Nonaka's SECI model and suggested modifications as well as improvements. There has been an apparent shift towards more dynamic knowledge management models where 3 overarching themes have appeared in the literature. (Gourlay, 2006; Heisig, 2009; I. Nonaka, Toyama, & Hirata, 2008) mentioned in order to achieve high quality knowledge management, it is important to understand human factors and behaviors at the micro level of interactions. On the other hand Cook & Brown, (1999), P. Sun, 2010; Tsoukas (2000), Von Krogh, Ichijo, & Nonaka, (2000), Zboralski, (2009) focused on the need to look at enabling factors within a context, more specifically within a community to understand how knowledge is created. As the third theme, building on Nonaka and Konnoo (2000)'s identification of a "ba" environment for knowledge creation, Stacey (2001) questioned transformational changes in knowledge creation while Bernier & Bowen (2004), experimented on creating an environment and testing its control and agility of knowledge development in a virtual setting (Arbabi et al., 2017; Harsh, 2009; J. Sun et al., 2017).

Researchers Jakubik, (2011); Nonaka et al., (2008); Serenko, Bontis, Booker, Sadeddin, & Hardie, (2010) acknowledge that the field of knowledge management has shifted from its core of quantifiable and measurable information towards knowledge creation, interactions and social practices with individuals in the community.

The knowledge acquisitions concepts need to be human-focused, mainly on people, culture and leadership. To support their claim, Jakubik (2011) defined the micro-level perspective of human behavior and engagement by mentioning the topic of immersion centered interaction based on psychologist Csikszentmihalyi (1990, pp. 88-89)'s flow theory. Based on Csikszentmihalyi (1990)'s interpretation of flow experience, individuals share common clear goals towards their experience to which, with interactions allow them to create feelings and these feelings gives them a sense of control on the possibilities of choices. Within the process of knowledge creation at the human level, individuals have an intrinsic motivation, such as a commitment to the learning process and view mistakes and challenges as a way to push their limits and learn. Similarly, (Senge & Scharmer, 2001, p.24) believes knowledge creation is an

“intensely human, messy process of imagination, invention and learning from mistakes, embedded in a web of human relationships. The more firms try to protect their knowledge, the more they risk destroying the conditions that lead to its generation. Organizing for knowledge creation may be very different from organizing traditional competitive advantage.”

On the practical end, Hardaker & Smith (2002), Li, Lai, & Luo (2016) argued with the increase in information, organizations cannot continue to ignore innovation and knowledge transfer. Very often they seek too much control on the learning process

without giving enough freedom to their employees. When building products, initiatives, they should focus on the needs of their staff members. In the same line, Grant & Baden-Fuller (2000) Jakubik (2008), Wenger & Snyder (2000), mentioned knowledge creation is shifting from a firm oriented to a network and community oriented knowledge process where knowledge is created through peer to peer interactions, commentaries, dialogues and reconceptualization.

“The focus on human is not enough”, mentioned Jakubik (2008), not only does the focus need to be at a micro-level, the scope should be contextual. Wenger (2000), Jakubik, (2008) quotes

“. . . groups of people informally bound together by shared expertise and passion for joint enterprise [. . .]”

People in communities of practice share their experiences and knowledge in free-flowing, creative ways that foster new approaches to problems. Researchers mentioned multiple characteristics of communities such that guidance is needed at the beginning, but they can become self-sustained (Cook and Brown, 1999; Tsoukas, 2000; Zboralski, 2009; Sun, 2010), collaborative learning approaches enhance critical thinking (Hardaker and Smith, 2002), individuals become responsible of their own learning where they follow a process of questioning the existence of solutions and assumptions while seeking new possibilities (Fagerholm & Helelä, 2003; Jakubik, 2008).

Von Krogh et al. (2000) interpreted Nonaka and Takeuchi’s SECI model differently when describing the transformation in the focus of content such as capturing, locating, transferring, sharing existing knowledge to contexts of knowledge creation taking into account enabling conditions (instill a vision, manage conversations, mobilize

activists, create the right context, globalize local knowledge) that result in increased new innovations. This is in line with Hardaker, Smith (2002)'s thoughts on a missed opportunity from learners to participate in an exchange of ideas where the appropriate level of interactivity is meaningful. This problem can now be answered via social communities enabled by the advancement of Information Technology (IT) which they could not in the past.

With an understanding of human factors, contexts of knowledge creation, researchers Gourlay (2006), Senge & Scharmer (2001), Stacey (2001) believe that the notion of transformative change is largely unexplored. Gourlay (2006) and Harsh (2009) criticized on how explicit knowledge is not always externalized tacit knowledge, but it is the representation of ongoing practices and the ability to exercise control over knowledge (over a period of time).

Control of an environment, includes the challenge of working with limited information as a survival technique to information overload. Hence the ability of an individual to detect value added information through a learning driven process (Cross, 1976) allows knowledge to be useful and reusable which consequently can increase the efficiency of knowledge creation (Hardaker, Smith, 2002; Harsh, 2009).

As an example, Bernier and Bowen (2004) have applied text-based online discussion forums as an attempt to control an environment and gain an ability to measure knowledge in virtual social context. Although it is only the start of understanding knowledge management within organization, (Arling & Chun, 2011, p. 231) mentioned that organizations still need to understand how to manage knowledge in order to achieve their goals.

Based on this literature review, researchers' suggestions and criteria, we seek to build on the environment defined by Nonaka et al. (2000)'s 3 key elements such as the SECI model, a mechanism used in exploring knowledge transformation from tacit to explicit (artifact). Ba, a platform to advance collaboration and knowledge sharing (task) and the initiative, motivation of individuals within this marketing course to lead creative ideas (person).

2.2 Immersive Learning

As we have seen in the introduction, the body of research on immersive learning has just recently (in the past 5 years) increased primarily due to advances in IT for gaming. In that regard, a literature review on immersive learning was conducted to understand the various learning approaches that can be used to construct immersive learning activities such as experiential, constructivist and collaborative, to provide interesting and effective opportunities for IT to create and engage students. We examine various literature introducing advanced technological inventions of virtual reality used in an immersive learning experience to then blend the importance of learning methods with technology and suggest future research ideas to contribute to the theory.

Previous research indicates active learning strategies are more effective than traditional passive learning styles (Inks & Avila, 2008; R. G. Saadé, Tan, & Kira, 2008). As education is relevant for institutions such as elementary, secondary, university and higher education, education is also relevant in training within the professional world (such as professional selling, manufacturing services, entrepreneurship) where new course delivery methods (such as hybrid, web-based courses) are used based on cost, time effectiveness, quality of the learning experience and individual learning styles and needs.

As authors Auster and Wylie (2006) developed a systematic approach to active learning, they include four interrelated dimensions of the teaching process such as context setting, class preparation, class delivery and continuous improvement.

Immersive learning, which can be considered as an active learning strategy, is complemented by various learning styles. Auster and Wylie's (2006) context setting involves the establishment of an atmosphere for learning that facilitates student interaction and engagement. Referring to Inks & Avila (2008), engagement relates to the quality and effectiveness of the learning experience where people learn better when they are fully engaged. It requires students to participate in discussions, reflect on their thoughts, solve problems, and be present in activities by which the learner is required to go through a cognitive process of new information presented. An effective, high quality context atmosphere requires a lot of monetary investment, by which researchers use technologies such as virtual realities with gamification and strategies to create an enticing environment for students to immerse in and learn. Not only should the environment be attractive but accessible to all those who wish to learn at low cost, otherwise true experiential learning may incur a high cost such as travelling expenses, extended time for readiness to experience, or investment in risky efforts which may not result in the experience intended.

In terms of class delivery, from PowerPoint to blackboard and chalk, the world has evolved into greater graphical delivery content such as 3 dimensional virtual realities which provoke a higher interaction of the content with the student using behavioral elements such as tactile, vision and auditory senses.

With respect to learning styles, it is worth noting that passive traditional learning styles create hurdles in customizing learning content for each student as their behaviors differ and their retention of the information vary from one person to another. With the start of web-based interactive content, allowing students to learn at their own pace, students and teachers can receive feedback and act in seeking continuous improvement such as coming back to a lecture, reviewing unclear content. Many learning management systems today monitor improvements on a regular basis.

Considering the above discussion, defining “immersive learning” can be problematic as it attaches itself to experiential, constructivist, and collaborative elements found in various activities designed to engage the participant. The literature always refers to “immersive learning” as it relates to a specific context and in the presence and facilitation of some form of information technology. In this research study, our literature review revealed that there are three primary perspectives at which “immersive learning” is utilized: In an experiential environment; through a constructivist method; and via active collaboration.

Experiential Immersive Learning (EIL) is represented by activities that allow students to immerse themselves in an artificially constructed world (virtual world) that may resemble reality. As Johnson and Levine (2008) describe, virtual worlds such as Second Life allow students to become part of a constructed world, interact with the virtual environment and learn from simulated experiences automatically created or arising based on a specific series of interactions (Milgram et al., 1994 ; Ştefan, 2012). Students’ interactions in EIL with people, activities, quests, tasks, objects and other simulated artifacts present an opportunity that may be hard to create in the real world due

to expenses and/or risks (Inks & Avila 2008). For example, students can visit a Nano scale environment in 3 dimensions to examine a photon and travel through a lesson in particles of physics delivered by an avatar of Einstein (Johnson & Levine, 2008). This experience provides students with a different view of the subject matter, both memorable and illuminating that the traditional classroom was not able to offer. It is also an environment where students can manipulate the parameters of their studies by creating visual effects in real time. EIL is very rewarding and engaging as immersing technologies including virtual reality and collaborative/social systems are now giving students and institutions access to a cost effective customized learning platform solutions (North, 2014).

Using the *constructivist learning method*, students are provided with opportunities to learn at their own pace. A constructivist online experience can be created today by customizing an environment designed by difficulty levels taking into consideration a student's prior knowledge and questioning these students on their unique misconceptions of a subject matter. To that effect, constructivism entails an interesting reflective and introspective element to learning, which entails the processing of knowledge that needs to be gained and assimilated. In an environment where instructors are able to create a personal connection, they can engage students in the reflective activities by observation and test them on abstract conceptualization of a specific subject matter, whereby knowledge contained within the activity may be guided or scaffolded. As a method of customization, information technologies allow educators to manage student's opinions, contributions, behavior, motion etc..., which may then update the environment in real time (Biocca & Delaney 1995). In constructivist-based online learning tools, teachers can

monitor the learning process of their students. Students can be allowed to be autonomous in their learning such that they can freely travel in the environment, interact with other students, and acquire information of interest while teachers can receive feedback on their students conscious and unconscious learning progress (Fernandes, Raja, & Eyre 2003).

Social or Collaborative learning (an activity that is very popular today with all the social networking websites) allows students to capitalize on the opportunity to share and learn from each other. Interactivity plays a crucial role in the world of immersive learning, as Kalay (2004) expressed, virtual surroundings allow group learning, similar to a class physical experience, where they are aware of the social process of learning and are affected by the presence and behavior of their peers. Technologies facilitate spatial and process visualization, which allows students to discover time sensitive and cultural backgrounds through graphical reconstructions (Ştefan, 2012).

To that effect, collaborative online learning tools become an asset for individuals to create working spaces for distant learners where they can meet, network, exchange experiences and knowledge (Ştefan, 2012a). A few examples of collaborative learning tools include using Mobile Augmented Reality models in architectural heritage through 3D visualization of media, (Kassim, Abdullah, Denan, & Arafat, 2017), Interactive distance learning delivery via blackboard which offers discussion boards and virtual classrooms Macfarlane & Robson (2017) as well as societies with the objective to use computer-supported collaborative learning (Ludvigsen & Arnseth, 2017).

The promised network is from student to student but also student to teacher as well as teacher-to-teacher in a global setting (North, 2014). Immersive learning that draws on IT support, social networking and gamification rely heavily on technological

and process-driven advances that are rich in user interfaces, represent realistic situations, represent complex pedagogical processes and the creation of an environment where students can engage and immerse themselves into experiences that fosters learning.

Collaborative learning focuses on the students as a group. Activities are created to foster a learning environment where students interact with each other, get insight in each other's thinking processes, discuss subject matter aiming to refine their knowledge and, in the process, enhance their overall cognitive abilities and skills. Collaborative learning is very common in a face to face classroom environment. However, with the recent advances in IT, new opportunities arise that increases the breadth of possibilities for IT-assisted collaborative methods that can be done in the classroom or online.

Student collaboration towards a learning goal draws on elements of discovery, sharing and negotiating knowledge (Kristensen, 1999). Considering those elements, discovery is an exploratory activity of an active learning form where students should construct their own knowledge from material provided by their instructor. Sharing, is a requirement for successful collaboration that requires effectively structured cooperation of students. Negotiation is a form of active participation which allows the student to practice their present knowledge and refine it through discussion, evaluation, and reflection (Pirker, Kultima, & Gütl, 2016)). These learning collaboration elements provide significant benefits and opportunities for deeper understanding of learning material via student self-discovery and autonomy resulting in an increase in motivation and engagement (Kersh, 1962; Saade, Nebebe, & Mak, 2011). We summarize below the conditions that foster a collaborative learning environment:

- Entails activities that allow students to immerse themselves in a process that may resemble reality.
- Students interact with elements such as other students, tasks, objects and knowledge artifacts.
- Students have the flexibility to learn at their own pace.
- Provide an environment that considers a student's prior knowledge.
- Allow students to question subject matter.
- Include reflective and introspective elements into the learning tasks.
- Allow the instructor to create a personal connection with the students.
- After reflective activities allow students to peer-test on subject matter at hand.
- Allow possibility where knowledge at hand may be guided or scaffolded within the activity.
- Monitor student learning progress updating the environment in real time providing opportunities for instructor to interact during the process.
- Allows students to capitalize on the opportunity to share and learn from each other, via feedback mechanisms. Provide an interactive environment giving students opportunities to explore and share in real time. Student should be aware of the collaborative process of learning.
- Have an environment affected by the presence and behavior of their peers. With various learning approaches, such as discovering, sharing and negotiating, we believe that integrating them together in some form and function can provide effective learning environments whereby computer assisted opportunities can be exploited to engage students in a collaborative learning environment.

Previous research indicates that active learning strategies are more effective than traditional passive learning methods (Inks, and Avila 2008). Engagement, as a critical element for a successful collaborative learning activity, relates to the quality and effectiveness of the learning experience and observed when students are immersed in the process. More explicitly, this is measured with the level of interaction occurring during

the collaborative activity, i.e. high noise level of student's discussions, not rushed to leave classroom, and in an online setting, the number of clicks and time duration spent using the collaborative tool. Collaborative learning requires students to participate in discussions, reflect on their thoughts, solve problems, and be present in activities by which they are required to go through a cognitive process of new information presented (Inks and Avila 2008).

Defining "Collaborative Learning" can be difficult as it involves many interrelated learning elements. In this article, we borrow from Johnson and Johnson (1991) "*the first requirement for an effectively structured cooperative lesson is that students believe that they sink or swim together.*" and "*While the essence of cooperative learning is positive interdependence, other essential components include individual accountability ... and group skills.*", to formulate our own definition as follows:

"Collaborative learning engages instructor (as facilitator) and student (as learner) in a learning partnership whereby both are equally responsible for the learning outcomes for enhanced interdependence, knowledge, and skills."

In an online setting, collaborative learning heavily draws on IT support for the creation of an environment where students can immerse themselves into knowledge discover, sharing and negotiation. To that effect, this study presents the design of an online collaborative learning tool and results.

2.3 Flow and Engagement

Students engagement is one of the most important aspect of implementing immersive learning technologies. Achieving flow in the learning process, is described by Csikszentmihalyi, (1990) as a state of full engagement. In a flow state, a person's level of concentration upon an activity increases; the person has the ability to block thoughts, concerns and worries unrelated to the project from their consciousness. The individual feels a sense of control toward the project and feels the self to be in a flow state.

In our dissertation, we look at the engagement level of each person during their use of our tool. To be more precise we look at the state of flow within the realm of e-learning and identify the most important aspects related to IT. Motivated by the need for more concrete and accurate ways to evaluate the state of flow, we identify important factors that may be used to better understand students' behavior and attitudes towards IT.

The literature on flow considers the necessity for an individual to be fully attentive to is environment Csikszentmihalyi (1975). Therefore research in flow considers the relationship between focus, concentration and flow (Esteban-Millat, Martínez-López, Huertas-García, Meseguer, & Rodríguez-Ardura, 2014). Davis & Wiedenbeck (2001) sees the mental process of an individual to be centered around their perception of a certain stimulus, as a result, attention is one of the most researched topics in psychology.

Research on flow in e-learning environments support the significant effect that focused attention help determine students' flow level (e.g. Kiili, 2005; Ryoo et al., 2008). Having a sense of control which is described as a feeling that arises when an individual are in control of their own actions and interactions with the environment (Koufaris, 2002; Rodríguez-Ardura & Meseguer-Artola, 2017). In an online environment, the perception

of control over the medium also helps to explain individuals' flow experiences. Multiple students such as (Chang & Wang, 2008; Koufaris, 2002) point out the relationship between the perception of control and the flow of the process. On the other hand, research studies mention the state of flow in virtual learning environments with their perception of control. (e.g. Inal & Cagiltay, 2007; Pearce, Ainley, & Howard, 2005; Rossin, Ro, Klein, & Guo, 2009; Ryoo et al., 2008).

Concentration is defined as the degree to which attention is totally focused when using a system (Dearman, 2015; Sánchez-Franco & Roldán, 2005). Csikszentmihalyi, 1990 had mentioned having clear goals and receiving immediate feedback were characteristics that facilitate an individual's concentration.

Several studies such as Meyer & Jones (2013) have reported the effects of time distortion on concentration. In addition, (R. Saadé & Bahli, 2004) mentioned the use of technology along with full attention to the virtual environment, give the individual the feeling of being transported through time and space. As Leong (2011) mentioned, the individual perceives time to pass quickly and often is surprised how quickly time passes.

As for curiosity, which is defined as a form of intrinsic motivation is key to fostering active learning and spontaneous exploration. Authors from the literature of flow have tried to define curiosity, however have not reached a consensus (Gottlieb, Hayhoe, Hikosaka, & Rangel, 2014; Kidd & Hayden, 2015; Oudeyer, Kaplan, & Hafner, 2007). Some state curiosity is often associated to a psychological interest for novel, complex activities, while others argue there is a knowledge gap or errors in prediction and have quantified curiosity mathematically (Barto, 2013; Oudeyer et al., 2007).

In an effective e-learning courses, the learner's enjoyment acts as a catalyst to encourage his/her learning initiative. Factors that could affect enjoyment are clear goals, including overall course as well as intermediate goals, autonomy (student feels a sense of control over their action) and feedback (student receive appropriate feedback at proper time). Csikszentmihalyi in 1990 even defined Enjoyment the closest characteristic to describe what flow is all about, meaning Enjoyment is a core for successful on-line activity.

Playfulness is the interactive component of hedonics, and has been described as a situational characteristic of a Website (Lin, Wu, & Tsai, 2005). Moon & Kim (2001) developed a measure they termed "perceived playfulness" and defined it as "the strength of one's belief that interacting with a WWW will fulfill his or her intrinsic motives." Similarly, Lavie & Tractinsky (2004) defined playfulness as "a state characterized by perceptions of pleasure and involvement," and developed a scale based on the work of Martocchio (1994), who had found a link between playfulness and satisfaction. In the context of software product design, Hassenzahl, Platz, Burmester, & Lehner (2000) that the ergonomic and hedonic qualities contributed almost equally to judgments of perceived fun of working with their website prototypes. Lin et al. (2005) evaluated models of Website usage and found that playfulness was related to satisfaction, and that intent to use a Website was affected by playfulness and perceived usefulness. In addition to being tied to satisfaction, playfulness has also been linked with aesthetics (Chung & Tan, 2003).

Researchers also studied motivational perspectives to understand behavior. Davis, Bagozzi, Davis, & Warshaw (1992) have advanced this motivational perspective to understand behavioral intention and to predict the acceptance of technology. They found intrinsic and extrinsic motivation to be key drivers of behavioral intention to use (Vallerand, 1997; Venkatesh, 1999; Wlodkowski & Westover, 1999) defined intrinsic motivation as an evocation, an energy called forth by circumstances that connect with what is culturally significant to the person. Intrinsic motivation is grounded in learning theories and is now being used as a construct to measure user perceptions of game/multimedia technologies (Venkatesh, 1999; Venkatesh et al., 2003; Venkatesh, Speier, & Morris, 2002).

2.4 Conclusion

In 2018, today, we are embedded within a world of information overload which has become the best opportunity to explore different facets of knowledge management unlike before when information was limited. Technology has brought us data that we could not find or imagine 20 years ago. Our theories in knowledge management, immersive learning, and flow have been the same as the past, but our perspectives have changed.

The ideas that knowledge management should be human focused, immersion centered, contextual and community oriented are not new, however the implementation and the complexity of technology acting as a catalyst to information allows us, as researchers to explore a much bigger, faster and complex world. We can now take a step back from the foundations and explore not only knowledge management, knowledge

acquisition at a large scale, we can also look into the emotions of a person, and their interactions with every other person within the community.

When we speak about immersive learning, we refer to new innovative platforms with immersion features such as games. On the other hand, the education world has shifted to adapt online learning and continue to confirm three learning methods such as experiential, constructivist and collaborative. In our dissertation, we would like to take this foundation and explore beyond modes of learning, or modes of platforms but rather a high level integration of all platforms and learning methods that generates the state of flow. Although some research work has been done joining these areas, to our knowledge, none include a unified investigation on knowledge management, flow, collaboration in e-learning therefore this will be the focus in this dissertation.

CHAPTER THREE: Theoretical Framework

The central theme of this study revolves around knowledge creation and knowledge processing in a state of flow, attained through the process of using an online learning tool designed for collaboration. Being in a state of flow suggests that the environment under which learning is to occur is immersive in some way. While most studies on immersive learning and immersive environments evolve around studies in relation to playing games, only a handful have investigated computer assisted immersive activities, and we have found none that is focused on knowledge acquisition and processing. Some of the latest publications include gamification in knowledge management initiatives (Ahmed & Sutton, 2017), mediating experiential learning in interactive immersive environments (Mostafa, 2018), however all center around virtual realities and less on learning.

The end result of this section is to present an integrated knowledge acquisition framework based on a formulated research model: The Technology Immersive Model - TIM. We will take the opportunity to introduce the works of Van Schaik et al., (2012), Finneran & Zhang (2003), Jackson & Marsh (1996), R. Saadé & Bahli (2004) Saade, Nebebe, & Mak (2011) which we integrate and adapt to the present context. Their research model validated constructs and items were adapted and applied to our study and used to formulate our theoretical model leading to TIM.

3.1 Recent Studies

Schaik, et al. (2012) was the only research we found that discussed immersive environments differently as compared to the other researchers who study immersive environments from a gaming context. Most importantly and as it relates to our context,

Schaik, et al. (2012) consider immersive environment as the state of engagement for learning purposes. Moreover, and more specific to the present study, Schaik et al. (2012) link immersive virtual environment to the state of flow studied by Mihaly Csikszentmihalyi. This is a critical and very important link between engagement and flow, when learning is the ultimate goal of the research. This is viewed as when students achieve a high cognitive functional state conducive for high performance followed by a high motivation to continue in an activity leading them to move gradually to higher levels of challenge as they gradually improve their skills and abilities. This is the essence of the state of flow experience.

Flow experience in an immersive virtual learning environment, is seen by Schaik et al. (2012) as a reflective higher-order construct with six dimensions of flow namely, margining action and awareness, where one heightens their level of concentration, control while losing self-consciousness, feels a transformation of time and enters an autotelic experience (Jackson and Marsh,1996). These precursors of flow is proposed as mediators of the effect of the person-task-artefact model (PAT Model by Finneran and Zhang 2003) in an attempt to measure the flow experience of students by setting an immersive environment. These dimensions therefore can be used for the study of immersive environments and signal different levels of engagements to measure flow factors such as anxiety, arousal, control, relaxation, boredom, apathy, and worry.

To complement the above, Kefor, (2015) described in his studies a validation for Csikszentmihalyi's state of flow whereby the degree of autonomy and self-direction given to students facilitates the flow experiences. One of the example would be to give students the ability to speak about and reflect on their flow experiences. In addition,

Kefor (2015) confirmed two additional elements in his thesis: The first point is based on Shernoff & Csikszentmihalyi (2008), that flow experiences dismiss the influence of time - Students gain a sense of slowing of time when they are at the optimal state of engagement. The second point, he mentions the importance of communal sensations whereby the dynamic peer relationships sustain students' flow experiences.

Schaik et al. (2012) reasoned that a true immersive environment must attain the flow state. And Kefor (2015), brought into the literature a confirmation of elements that facilitates the state of flow first defined by Csikszentmihalyi since 1990, leads us to a large arena of research possibilities in order to explore immersive environment, specifically experiential immersive learning with the use of information technology.

We build on the aforementioned ideas along with Saadé, R., & Bahli, B. (2005)'s cognitive absorption scale on perceived usefulness and perceived ease of use in on-line learning to understand the knowledge creation process of a person experiencing the student-task-artifact environment. The Saadé, R., & Bahli, B. (2005) research model takes into account the flow state of engagement and combines technology through online learning. In our dissertation, we enhance the model by adding the dimensions of the SECI Model (Socializing- Externalizing-Combining-Internalizing knowledge) integrated into the Task as well as collaboration, the nature of the Artefact.

We adapt the PAT model (Figure 3.1) to be student learning focused. Our modified diagram is shown in Figure 3.2. We measure students' performances and engagement level through their state of flow. Task is enhanced utilizing the SECI model as a process, and Artefact, which is the tool allow this immersive environment to exist.

The intersection of all 3 brings us Knowledge Creation, which is the ability to take knowledge through the process of knowledge acquisition and create new knowledge.

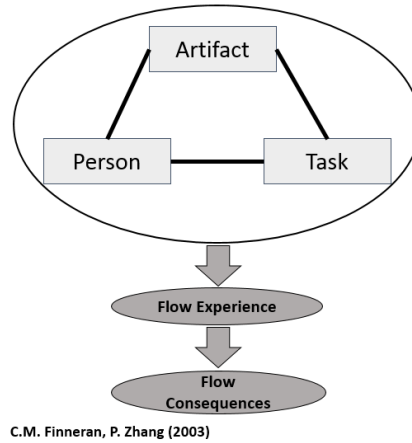

Figure 3. 1 Stages of flow and the person-artefact-task model of flow antecedents from Finneran & Zhang (2003)

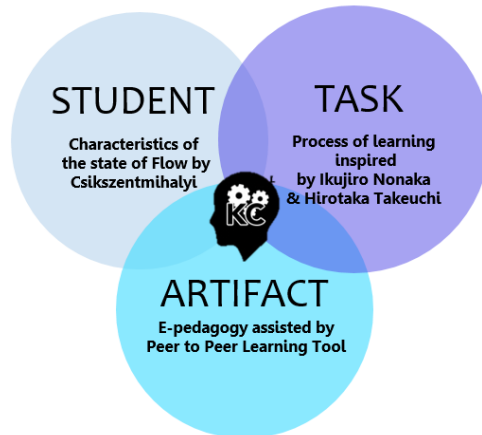

Figure 3. 2 Modified to Student-Task-Artifact with embedded theories

In Table 3.1 we showcase the intersections and explanations of each components of the modified Student-Artifact-Task diagram.

Table 3. 1 Intersection between student and task- artifact intersection.

	Flow	SECI Model	Collaboration
Student (Learning)	experiences flow	gains knowledge	immerses in collaboration
Task (Pedagogy/Process)	measures the effectiveness of the pedagogy	transforms the knowledge framework for pedagogy	follows the process
Artefact(Tool)	engages the environment for flow	processes the knowledge	engages groups to allow collaboration

- Student
 - The student experiences flow, gains knowledge and immerses in collaboration.
- Task
 - The task defined as the pedagogy or process uses flow to measure its effectiveness, utilizes the SECI model to transform its knowledge framework and allow for collaborations.
- Artefact
 - The artefact, in this case defined as the e-learning tool engages the environment of flow state encourages the SECI model through the process of knowledge and sets an environment for groups to collaborate.
- Student-task
 - The student undergo, through the task the process of externalizing (documenting their knowledge) and internalizing (comparing to their peers) transforming their tacit knowledge into explicit knowledge.
- Student-Artefact
 - The artefact provides a fertile environment for students to engage in immersion of their knowledge acquisition process (self and others) while keeping track of the effectiveness of the activities.
- Task-Artefact
 - The tool development process took into account the full process of the SECI Model allowing a concise three steps automated process of knowledge creating, socializing and performing.
- Student-task-artefact
 - The three pillars model brings together three dimensions (flow state, seci model, and technology) that ultimately allows students to create knowledge.

3.2 Flow

To elaborate on the use of Flow, after understanding the current literature, we want to question whether our three pillars model can facilitate the state of flow during the tasks. Using flow terminology as shown in Figure 3.3 below, our research seeks to identify to what extent students' skills (in our context level of knowledge) match their challenges (in our context difficulty level of questions), which was measured quantitatively through performance scores, and task difficulty level, respectively, and qualitatively through a consistent flow state scale used in Saadé and Bahli (2005) model including the constructs of temporal dissociation, focused immersion and heightened enjoyment. We modified Csikszentmihalyi (1990)'s flow diagram to reflect our context in Figure 3.4. The level of difficulty of questions replaces challenge level, while knowledge level replaces skills. The level of skill increases as the student practices and collaborates through Nonaka et al. (2000)'s SECI Model to achieve higher knowledge acquisition in a state of flow and maintained within the zone of flow. Whenever the challenge is too high in comparison to the skill level, students feel heightened anxiety, on the other hand, if the challenge is too low for the student, they experience boredom.

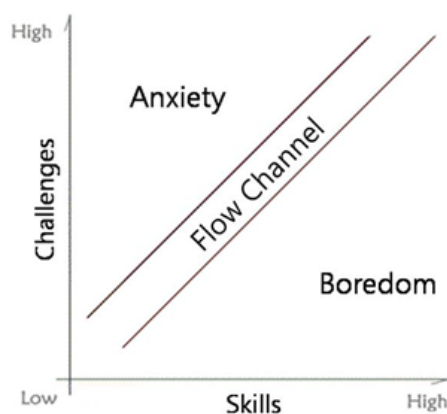

Figure 3. 3 Csikszentmihalyi (1990)'s Flow diagram

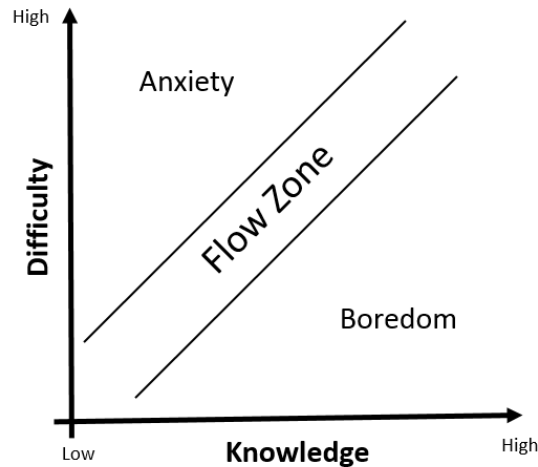

Figure 3. 4 Modified Flow graph with Difficulty and Knowledge

3.3 Knowledge Processing: The Socialization-Externalization-Collaboration-Internalization Model

In our research and with regards the online learning collaborative tool, Nonaka et al. (2000)'s SECI Model becomes the primary focus of which the learning process would take place. Hence, we superimposed each step of the activity taken by students with Nonaka et al. (2000)'s Socialization, Externalization, Combination, Internalization model with 3 phases such as create, evaluate and perform.

In the first phase P1 Create as shown in Figure 3.6, whenever students are asked to create knowledge, they are combining external information. Also, but writing down and creating questions, they are externalizing their tacit knowledge (knowledge they have but may not be aware of) into explicit knowledge (knowledge that is documented or expressed verbally).

In the second phase P2 Evaluate, as students are reviewing and evaluating their peers' creations, they are internalizing the knowledge of others such that they must identify the task as relevant and identify themselves within the large entity. This steps

transforms documented knowledge into a student's tacit knowledge. At the same time, the student interacts by socialization with the work of their peers and receive feedback from each other.

In the last phase P3 Perform, students take a tradition quiz created by themselves and their peers, this steps becomes the outcome of phase P1 and P2 where their knowledge is solidified and tested for results. We are therefore able to measure their performance and knowledge level.

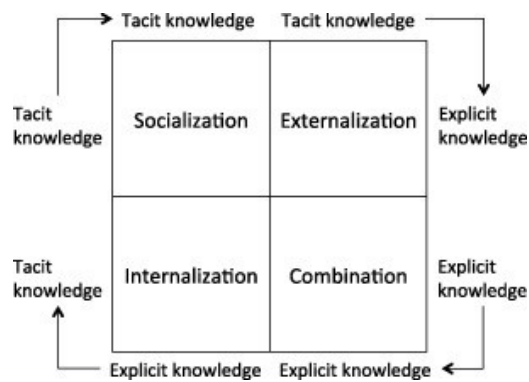

Figure 3. 5 SECI Model proposed by Nonaka et al. (2000)

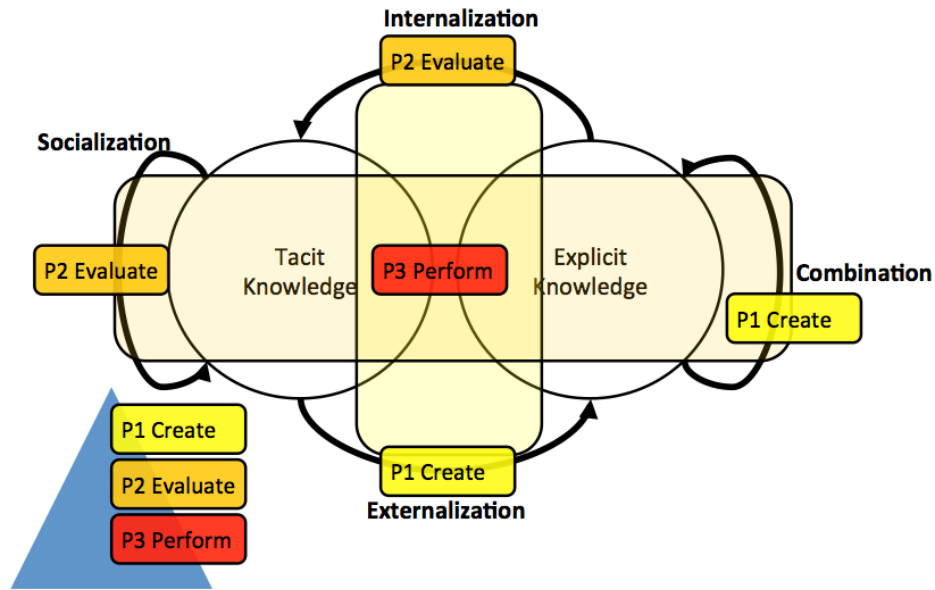

Figure 3. 6 Enhanced SECI model including 3 Phases

Considering the above theories, we propose below a three pillars integrated knowledge acquisition model that includes the Finneran and Zhang (2001) PAT model, the flow state introduced by Csikszentmihalyi (1990), and the SECI model defined by Nonaka et al. (2000) to study learning in an immersive collaborative environment.

3.4 Integrated Knowledge Acquisition Model

The theoretical model presented in figure 3.7 below is put together within a collaborative perspective consisting of Student, Task, Artifact as the capabilities, where students experience in a 3 steps immersive learning activity (create, evaluate, perform) aligned with learning goals and result in a measurement of performances. The model pyramid entails four levels namely, starting from the base, capabilities, execution, strategy and results.

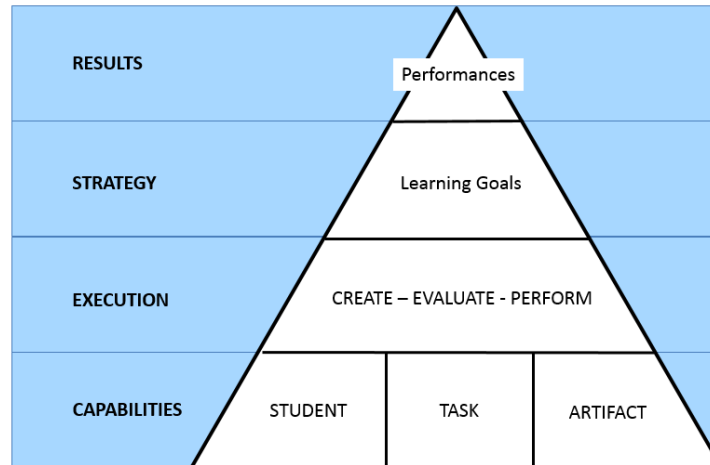

Figure 3. 7 IKAM Integrated Knowledge Acquisition Model

Considering the elements of IKAM depicted in the figure above, we expand on the linkages and interactions:

IKAM represents the summary of components part of the design of a tool defined as immersive. Within this structure are the capabilities, execution methods, high level pedagogical strategies and results based on performances.

Capabilities is defined with Person-Artifact-Task, these are the 3 main ingredients allowing us to assess knowledge creation. There is a need of a group of students (Persons), a platform (Artefact), and an activity (Task).

The Execution method overlays on Nonaka's knowledge processing of the SECI model reflected through Create-Evaluate-Perform, the 3 phases of the activity.

The Strategies to learning are defined by learning goals such as Benjamin Bloom's taxonomy (Bloom, 1956) founded from remembering, understanding, applying, analyzing, evaluating to creating a subject matter. (We do not elaborate on Bloom's as it is outside the scope of this dissertation).

And finally results are measured by performance with a score given to each student, which has been the universal performance indicator.

We are suggesting the combination of the Integrated Knowledge Acquisition Model (IKAM) can provide information for any type of Immersive Environment which will be measured in our dissertation through the Technology Immersive Model (TIM).

3.5 Research Questions

Figure 3.7 represents IKAM and as such shows the design elements of the online collaborative learning tool. In our research, this model is put through the theoretical lens of immersive learning and flow and therefore needs to be tested and validated. Therefore, in order to validate our model, we proceeded with a series of exploratory experiments starting by testing the acceptability of technology by students, followed by improvements to the collaborative learning tool and finally assessing the validity of IKAM via a theoretical model for immersive learning environments and flow.

To that effect, our goal is to propose and test a theoretical model, which we named the Technology Immersive Model (TIM) to help explain the state of immersion and flow in online learning environments. Therefore, our research questions:

1. What are the significant constructs that help explain collaborative immersive online learning environments;
2. How are the constructs related to each other;
3. Are there any mediating effects among the constructs? And
4. What design parameters should be considered to achieve a state of flow in online learning.

In the next chapter, we present to you our technological tool allowing us to carry the research and validating the IKAM Model.

We take a closer look at the IKAM framework by explaining the methodology of each experiment as well as present the details of our online learning tool from its first version to its final iteration. Lastly, we reason the theoretical perspective of IKAM, and suggest a model to assess the level of immersion by providing the theoretical background of scales used. Based on the literature, we integrated together measure of flow of immersion to model the Technology Immersive Model (TIM), which can be used for any type of learning tool.

Overall, TIM and IKAM come together. IKAM is a structure adapted to any type of learning where researchers can take IKAM, build their pedagogical tool, and run it with TIM to test for the process of achieving Immersion.

CHAPTER FOUR: Methodology

4.1 Context

The peer-to-peer (P2P) learning tool used in this study is a web-based interactive system for student learning and assessment. It facilitates a process of knowledge creation, knowledge evaluation and synthesis, and assessment of knowledge gained (or in the present case, learned), as elaborated by Nonaka et al. (2000). The P2P tool was first created with the purpose for academic research. Observing traditional practice with classroom activities, we note that pedagogy in many classrooms was still unidirectional from teacher to students where the interactions of both parties consisted of primarily lecturing, and at best some limited discussions. In General, teachers either created quizzes/tests questions by developing them from their own perspective, or, as most do, utilize questions from a pool provided by publishers, when one of their books are adopted. Today, this approach has become problematic and insufficient in many ways, such that a level of frustration, lack of motivation, and general apathy exists in teachers and students alike, as well as a systemic issue with students' engagement level, their lack of interest and plagiarism due to effective utilization of the Internet and social media.

As a result, there was a motivation to create a tool to “bring subject matter questions to life” and resolve this general apathy towards the practice of testing, motivation to participate in testing, and plagiarism. Hence, the P2P idea was conceived and piloted. At first, the P2P process was tested a few times in classrooms manually, without the use of information technology, then later developed as a web-based learning tool (Computer Assisted Learning Tool).

4.2 The Computer Assisted Learning Tool

The P2P learning tool was used in different courses over a period of 2.5 years: PhD, Master in Business Administration (MBA), undergraduate year 3, undergraduate year 1, in a virtual setting (online course), in a classroom face-to-face setting, and in different subject matter (Information Technology, Information Systems, Project Management, Enterprise Resources Planning, Pedagogy, Marketing, and Finance). It was important for the study to test the tool's applicability to as varied contexts as possible.

The P2P learning tool is web-based and accessible via any browser on any computer platform and device (phone, ipad, etc...). The tool basically reproduces a classroom teaching method and enhances on its pedagogy that is based on the generation of questions followed by a test. In brief, the P2P tool is composed of three phases where given a subject matter (or more appropriately, a knowledge artifact such as a chapter, a concept, an article, a website, etc...), students are asked to create X number of questions related to that knowledge artifact, followed by peer assessment of the students-generated questions on level of difficulty and level of quality. Based on high quality questions, the teacher then selects a pool of questions in a testing format and which students are then asked to take. The P2P is a tool that involves three phases that encourage the active participation of the students in a knowledge processing activity. Therefore, the P2P tool process entails learning of the subject matter as well as assessment of what is learned, all in a fully transparent mode. We elaborate below on the process:

Phase 1: The professor has four parameters to specify: starting date, end date, subject matter including resource, and number of questions to be generated. The students are presented with the subject matter (Knowledge artifact) and instructions and given a

predetermined time to study it. The students are then required to submit X number of questions using the tool. For example, if the class has 100 students enrolled and the professor has required each student to enter 5 questions, then 500 questions would be generated. Subsequently, all the questions would be logged into the P2P database. The professor can monitor the student's activities in real time and intervene if necessary. Once all students have submitted their questions, the professor can close this phase and initiate phase 2.

Phase 2: In addition to setting the start and end dates, this phase requires the professor to specify the number of evaluations he/she would like to have for each question. Based on that number (say 5 evaluations for each question generated), the tool calculates the number of questions that every student needs to evaluate. Each student can now rate other student's questions on level of difficulty and level of quality. Therefore, if a question is not clear or even has a typing error or is grammatically incorrect, the students may rate it as low quality. The scales for both difficulty and quality are low, moderate and high. Again, the professor can see on his/her dashboard the progress of the students. When everyone has completed their assessment, the professor closes this phase. At this point, students can see how their peers rated their questions on both quality and difficulty. The professor can now close this phase and setup phase 3.

Phase 3: At this point the professor can give the students a small break so he/she can setup the tests for phase 3. The professor, in this phase, can see all students' questions and can filter and sort by quality and difficulty and create one or more tests. The professor can edit the questions and can control the number of questions on both levels of difficulty and quality. Moreover, the professor can select a pool of questions and

specify to randomize a subset of the questions for the test. This way, students can have different tests.

During this P2P learning process, students are encouraged to provide high quality questions by receiving additional marks should their questions be chosen to appear in the test.

Addressing the value-added of this process to the student learning, we can ask what can the P2P Offer?

Table 4. 1 List of Features within the P2P System

Inter-Activity	Features within the P2P System that addresses these needs
Social Collaboration	Students create questions with the collaboration of their peers or on an individual basis. Then they share with each other their created questions for peer evaluation.
Active Measurable learning	At all times, the P2P instructor dashboard shows each students' activities, phase 1-3 scores and real time updates to allow instructors to tailor the learning to each students' speed.
Remedial and Contextual	Given the tool can allow students to build questions at their own pace, they can take from their knowledge and be creative. If they need special needs and accommodation, the instructors can change several features such as exam time, required questions created.
Supplement and Added Engagement	This tool allows instructor to gain control over the course material taught but at the same time supplements the learning progress of student through an engaging learning environment. This is definitely an instructor supplement tool as it cannot exist or be ran without the instructors' supervision and input.
Student Owned	Students take control over their learning material, the questions they want to create, and the time frame needed to complete such questions. P2P can run online as well as in-class format giving flexibility to both teachers and students.

Table 4. 2 Summary of theoretical learning methods with tradition implications and goals

Theoretical Foundation	Implications for Instructors	Goals
Objectivism	Control of material and pace	Transfer knowledge peer to peer
	Provides stimulus	Recall of knowledge
Constructivism	Learner-centered active learning	Formation of abstract concepts to represent reality
	Instructor for support rather than direction and instruction	Assigning meaning to events and information
Collaborativism	Communication oriented	Promote group skills – communication, listening, participation
	Instructor as questioner and discussion leader	Promote socialization
Cognitive Information Processing	Aspects of stimulus can affect attention	Improve cognitive processing abilities of learners
	Instructors need feedback on student learning	Improve recall and retention
Socioculturism	Instruction is always culturally value laden	Empowerment Emancipatory learning
	Instruction is embedded in a person’s everyday cultural/social context.	Action-Oriented, socially conscious learners with a view to change rather than accept or understand society

Despite a shift in society’s perception of learning today and it’s present hurdles for higher education institutions to implement information technologies in their pedagogies while adapting with technological advances, the state of meaningful integration of these technologies in the education sector remains scarce. To that effect, and since I am advocating in this study that this meaningful integration is possible, in this next section, I would provide a detailed analysis of the Peer to Peer system and discuss how this is a meaningful and a suitable technological tool for learning and pedagogical

design. How, based on our previous analysis, this tool should be implemented and why it is an important evolution to the teaching world?

The majority of those who jump on the technology bandwagon and adopt it in the classroom, don't necessarily know what to do with the equipment in order to get the best from it educationally. Early adopters of technology may choose a particular technology without considering a specific learning or teaching focus. This is a key challenge for proponents of technological solutions in education (Higgins, Xiao, & Katsipataki, (2012). Putting the concepts together from Carmean & Haefner (2003), Furneaux, (2004), they identify 5 categories of learning principles effective and efficient learning practices as follows (as presented in Table 4.1 above):

1. Social Collaboration, whether it is university or elementary school, technology should foster collaboration and improve communication between individual students, their pupils, and with the teacher facilitates group learning activities.
2. Active measurable learning, measurable, where students gain the incentives of obtaining real-time data of their performances in regular, short frequent use while emphasizing on exploration, practice and reinforcement. Effective information management strategies
3. Remedial and Contextual, not only does it allow student to learn based on their own previous knowledge base and existing conceptual frameworks, it also aids and support the low attaining pupils with the speed of their learning and have the ability to customize for their special needs.
4. Supplement and added engagement, technology should engage students by creating a high –challenge, low threat environment, it should be complimentary to teaching and not as a substitute.
5. Student owned where students organize materials and take control of the planning of their work. (Carmean & Haefner, 2003)

The emphasis of the P2P learning tool is on student-centered teaching, where the student who is responsible for his/her own construction of knowledge seems to be reflected well in this tool. For example, students must develop their own questions which they then submit for peer rating. To be able to formulate questions, students must have a deeper understanding of the subject matter. In addition, to be able to determine or rate the submitted questions, students must also show a deeper understanding of the subject matter. We agree with the opinion that the best way to ensure that you understand a topic is to try to teach it to someone else. In order to do this, one needs to be able to formulate questions.

The P2P learning tool includes elements that are experiential, constructivist and collaborative. These elements have been elaborated in the literature review section above. In this section, we map those elements to the P2P components / processes / phases. The following immersive elements are mapped to the P2P tools keeping in mind that students while using the tool are playing the roles of the teacher, evaluator and learner (TEL), depending on the time and place (phases and tasks) they are engaged in.

Experiential: Students become part of the TEL constructed world, interacting via the tool environment and learn from simulated experiences as their tasks change depending on the role they are engaged in – teacher, evaluator, learner.

Students interact with other students, tasks, documents, websites, articles, and knowledge artifacts managed by the tool. Students can manipulate the parameters of the knowledge creation process by viewing other student's created knowledge and provide assessment of that knowledge.

This experience of creating knowledge, evaluating that knowledge, and assessing their learning provides students with a different view of the subject matter, as well as insight into other student's thinking of the same subject matter that are both more memorable and illuminating than traditional methods which are not able to offer.

Constructivist: The P2P activity can be done virtually or in the classroom. In either case, enough time can be given to students to complete the tasks and learn at their own pace.

An environment designed in consideration of a student's prior knowledge and questioning these students on their level of understanding of the subject matter at hand.

Includes reflective and introspective element to their learning, which occurs during and entails the processing of knowledge that needs to be gained and assimilated.

The instructor can create a personal connection by engaging students in the reflective activities and test them on the subject matter.

As part of customization, educators to manage student's contributions, behavior, and knowledge acquisition, which updates the environment (in phase 2 for example) in real time.

Teachers can monitor the learning process of their students by seeing their contributions in each phase in real time, and in the case of a classroom setting, the teacher can interact with the students and provide feedback in real time.

According to Hoy, Davis, & Anderman, (2013), constructivists argue that learning needs to be looked at from the student's perspective. Thus, if the questions are coming from the students, then they are the ones asking the questions, which they find pertinent

to their learning process. This is another indication of how this tool is based in the constructivism theory of learning.

Furthermore, constructivists argued that letting students direct the questioning and discussion that takes place in the classroom would result in more meaningful learning from the students' perspectives. In this case, the classroom may be online and the social ties necessary for learning to take place per this view are virtual, however, the creating of the questions and the rating of each other's work, still makes for meaningful learning for the students.

Collaborative learning: Students capitalize on the opportunity to share and learn from each other, by evaluating the knowledge created by others (phase 2) and reflecting on the evaluation of others on their own work (phase 3).

Students are aware of the process of learning, the role they are playing in every phase, and are affected by the presence and behavior of their peers.

The P2P facilitates the process of visualizing the student's role and tasks to be done in each phase, which allows them to discover knowledge sensitive backgrounds.

In summary, this teaching tool seems to be supported by the constructivist and cognitivist theory of learning since it allows students to direct their own learning based on their own integration of knowledge and their ability to direct the questioning. It is important to note that the P2P system used in this study entailed two versions. Feedback from the first version was used to develop a new enhanced P2P system with added features. Next we showcase the two P2P versions used in our experiments for the sake of completion.

Table 4.3 identifies and elaborates on the two versions of the P2P system used in this study. In 2015, a new version was developed with enhancements to the previous version. It is important to note that the pedagogy and principles that the P2P was based on were still the same. In the first version, we implemented a basic platform showcasing the 3 steps process create- evaluate-perform, students had a platform to create questions, evaluated questions based on difficulty and quality and at the performance stage teachers had the ability to filter questions and choose the number of questions. Our next version added much more complexity and ability to collect data. A grading scheme can now set a weight to each of the 3 phases, for example, create (50%), evaluate (25%), perform (25%) allowing teachers to shift the focus to creation and less on performance. The new version defined “difficulty” better, such that we broke down difficulty by clarity of a question, relevance to the subject and difficulty of the question on a scale of 1 to 7. Inside the performance phase, teachers had the ability to see who created the questions, allocate different points for easy (.5points), medium (1points) and hard (1.5points) questions. The system also allows teacher to set different quizzes for each student by pulling questions from a selected pool. Finally, the new platform allows teachers to filter and assess by ethnicity and gender. For example, the teacher can give a quiz to all males made of questions created by the females. In our new design, the feedback phase was done within the system as part of the activity. In the following Figures 4.1 to 4.8, please find screenshots of the peer-to-peer platform.

Table 4. 3 Summary of the P2P platform integration

Year	Design	General	Creating Phase	Evaluation Phase	Testing Phase	Feedback
2014	Black and Beige	3 Phases with dates of submission.	Question creation and answers. Answers were created by editing was uneasy. Each stage was set at a deadline and the teacher must unlock.	Evaluation had 2 variables (difficulty and quality) with 3 point scales 1, 2, 3.	The testing phase allowed the teacher to create a test by generating the highest, and various types of questions by difficulty.	Paper Based
Updated in 2015	Blue and White	Incorporated with the learning platform. 3 phases automatic opening with dates of submission.	Question creation okay. Answer entry is automatic. In the creation phase, student can input their level of difficulty	Evaluation became 3 variables with difficulty, clarity and relevance. The scale became 7 points in a cursor format.	The testing phase allowed the teacher to create multiple test within the same cohort of students where they can take multiple tests. There is also an integration with demographic variables such as gender, education, country. Teacher can also choose from the automatic questions as well as shuffle a set of questions for different students.	Within the system

LEARNING LAB
eLearning • Research • Innovation

INTRODUCTION TO MARKETING
GB101 • Course Info • Registration Settings

DASHBOARD STUDENTS & TAS QUESTION CENTER 10 NOTIFICATIONS MANAGE

Edit Student Account

FIRST NAME * LAST NAME * PHOTO No file chosen

COUNTRY ETHNIC BACKGROUND

EDUCATION LEVEL

GENDER

STUDENT ID ASCD Student

Email Confirmed

COURSE REGISTRATION DATE

Login Credentials

EMAIL *

PASSWORD

[Generate new password](#)

Email credentials to user

Figure 4. 1 Version 2 Interface – each student has their respective profile

LEARNING LAB
eLearning • Research • Innovation

INTRODUCTION TO MARKETING
GB101 • Course Info • Registration Settings

DASHBOARD STUDENTS & TAS QUESTION CENTER 10 NOTIFICATIONS MANAGE

Task Configuration

P2P MIDTERM Review

Session Info Phase 1 Phase 2 Phase 3

QUESTION TYPES

Multiple Choice Questions

Essay Questions (N/A)

CONCEPTS

BCG Matrix x Consumer market x

Experimental Research x Exploratory Research x

Market Segmentation x Primary Data x

Secondary Data x

Figure 4. 2 Version 2 Interface: allow the teacher to set up 3 phases with concept tags

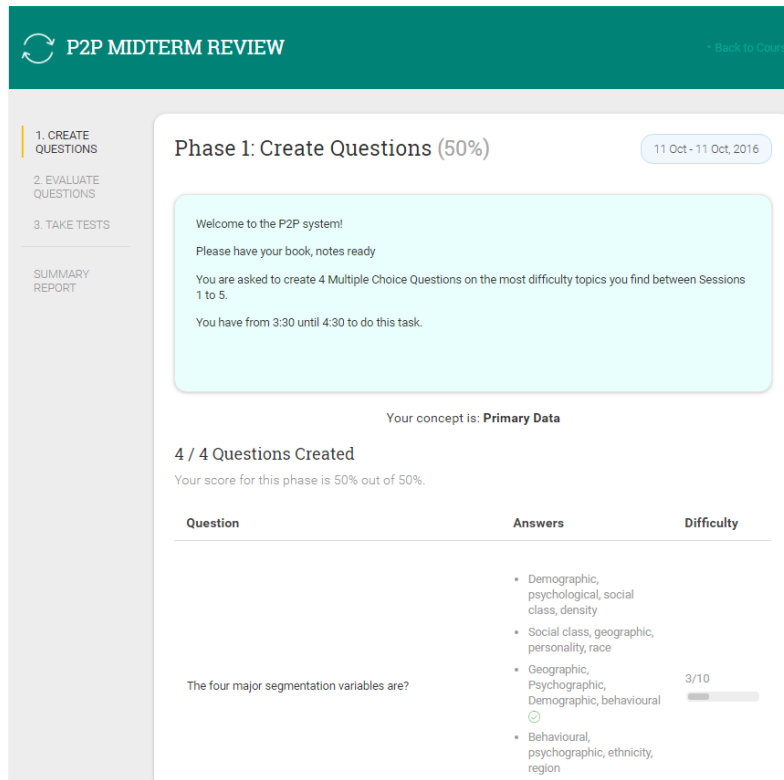

Figure 4. 3 Version 2 Interface - Students create questions and set difficulty



Figure 4. 4 Version 2 Interface Student report view on their own questions

The screenshot displays the 'Task Configuration' interface for a 'P2P MIDTERM Review'. At the top, the 'LEARNING LAB' logo is visible with the tagline 'eLearning • Research • Innovation'. The user 'SAMIE LY' is logged in. The course title 'INTRODUCTION TO MARKETING' is shown with a 'Back Home' link. The navigation bar includes 'DASHBOARD', 'STUDENTS & TAS', 'QUESTION CENTER' (with a notification badge of 10), 'NOTIFICATIONS', and 'MANAGE'. The main content area features a 'Task Configuration' header with a 'View Activity' button. Below this, there are tabs for 'Session Info', 'Phase 1' (selected), 'Phase 2', and 'Phase 3'. The configuration panel includes:

- START DATE:** 2016-10-11
- END DATE:** 2016-10-11
- TOTAL QUESTIONS *:** 4
- INSTRUCTIONS:** A rich text editor containing the text: 'Welcome to the P2P system! Please have your book, notes ready. You are asked to create 4 Multiple Choice Questions on the most difficulty topics you find between Sessions 1 to 5. You have from 3:30 until 4:30 to do this task.'
- Upload File:** A button to upload additional files.
- SCORE WEIGHT *:** A slider set to 50%.
- End student participation and start next phase (if dates allow it):** A checked checkbox.

 At the bottom of the configuration panel are 'Save' and 'Back' buttons.

Figure 4. 5 Version 2 Interface - Teacher's view of phase 1, they can set score weight and instructions

LEARNING LAB
eLearning • Research • Innovation

SAMIE LY

INTRODUCTION TO MARKETING
GB101 • [Course Info](#) • [Registration Settings](#) • [Back Home](#)

DASHBOARD STUDENTS & TAS QUESTION CENTER 10 NOTIFICATIONS MANAGE

Task Configuration

P2P MIDTERM Review View Activity

Session Info Phase 1 Phase 2 **Phase 3**

START DATE: 2016-10-11 END DATE: 2016-10-11

INSTRUCTIONS

B I U [List] [Table] [Image] [Video] [Audio] [Link] [Text] [Code]

You will now have 25 minutes to attempt 20 MC questions.

SCORE WEIGHT * 25%

End student participation

Tests

Test	Questions		
Midterm Simulation F	10	<input type="checkbox"/>	<input type="checkbox"/>
Midterm Simulation M	10	<input type="checkbox"/>	<input type="checkbox"/>
Midterm Simulation	10	<input type="checkbox"/>	<input type="checkbox"/>
P2P Generated Test	388	<input type="checkbox"/>	<input type="checkbox"/>

Done adding tests

Figure 4. 7 Version 2 Interface – Test Creation Phase – Teacher’s view

P2P Test

Submitted by **Ben Jerry** on **Oct 12, 2016**. Score: **33.33%**

According to Maslow, human needs are arranged in a hierarchy. Start from more basic needs to the most advanced needs



Self actualization need, esteem needs, social needs, safety needs, psychological needs.

1 points

esteem needs, safety needs, self actualization need, psychological needs, social needs

safety needs, social needs, psychological needs, self actualization need, social needs.

self actualization needs, psychological needs, social needs, safety needs, esteem needs

psychological needs, safety needs, social needs, esteem needs, self actualization need (1 points)

esteem needs, safety needs, self actualization need, psychological needs, social needs

safety needs, social needs, psychological needs, self actualization need, social needs.

self actualization needs, psychological needs, social needs, safety needs, esteem needs

None of the above

What 4 things does a SWOT analysis analyze



Strengths, threats, competitiveness, opportunities

1 points

Profitability, weakness, target market, strengths

Opportunities, strengths, weaknesses, threats (1 points)

Accessibility, advantages, threats, elasticity

Strengths, weaknesses, orientation, threats

Under Armour was initially a company that specialized in the clothing industry and recently started branching out into the shoe industry. After analyzing their first year in the market, they found out they were doing extremely well and has potential to grow in this industry at an incredible rate. Would you consider putting Under Armour shoe products within the category of



0 points

Dog

Question Mark

Cash Cow

Star (1 points)

Cat

Figure 4. 8 Version 2 Interface – Test Phase – Student's view

4.3 The instrument

After Phase 3, students are asked to complete a questionnaire where the answers to the questions (items) were on a 7-points likert scale. The questionnaire is given in table 4.X. The items used were obtained from validated studies, namely the Technology Acceptance Model (TAM) by (F. D. Davis, 1989), Motivational Model (MM) by (F. D. Davis et al., 1992), Cognitive Absorption model by (R. Saadé & Bahli, 2004)(RS&B), UTAUT by (Venkatesh et al., 2003). Each items is identified by its source in Table 4.3.

Table 4. 4 Instrument with sources of items

Author Coded	Description of the Question	Source
Temporal Dissociation		
TD	Sometimes I lost track of time when I was using the P2P SYSTEM	RS&B
TD	Time flew when I was using the P2P SYSTEM	RS&B
TD	Most times when I got on to the P2P SYSTEM, I ended up spending more time than I had planned	RS&B
Focused Immersion		
FI	When I was using the P2P SYSTEM, I was able to block out most other distractions	RS&B
FI	While using the P2P SYSTEM, I was absorbed in what I was doing	RS&B
FI	While using the P2P SYSTEM, I was immersed in the task I was performing	RS&B
Heightened Enjoyment		
HE	I had fun interacting with the P2P SYSTEM	RS&B
HE	Using the P2P SYSTEM Bored me	RS&B
HE	I enjoyed using the P2P SYSTEM	RS&B
Design Based items		
	Tell us about your experience with the P2P System. How satisfied are you with the quality of the outcome which you and the other party reached?	
	To what extent does the final outcome realistically reflect your objectives?	
	To what extent are you confident that the outcome is acceptable?	
	How would you describe the P2P System process you and the other party used? Efficient to Inefficient	
	How would you describe the P2P System process you and the	

other party used? Coordinated to Uncoordinated
 How would you describe the P2P System process you and the
 other party used? Fair to Unfair
 How would you describe the P2P System process you and the
 other party used? Satisfying to Unsatisfying

Performance Expectancy		
PE	I find the P2P Program useful.	UTAUT; TAM
PE	Using P2P Program enables me to accomplish learning tasks more quickly.	UTAUT; TAM; RS&B
Perceived Usefulness		
PU	Using P2P Program increases the effective use of my time in handling learning tasks/assignments.	RS&B
PU	Using P2P Program increases the quality of my learning tasks at minimal efforts.	RS&B
Behavioural Intention to use the system		
BI	I intend to continue using the P2P system.	UTAUT; TAM
BI	I predict that I would use the P2P system in the future.	UTAUT; TAM
Perceive Ease of Use		
PEU	My interactions in P2P Program is clear and understandable.	RS&B
Effort Expectancy		
EE	I am skillful at using P2P Program.	UTAUT; TAM
EE	Learning to use the P2P Program is easy for me.	UTAUT; TAM
EE	I find it easy to get the P2P Program to do what I want it to do.	UTAUT; TAM
Facilitating Conditions		
FC	I have the resources necessary to use the learning systems (websites) at the university.	UTAUT; TAM; MM
FC	I have the knowledge necessary to use the learning systems (websites) at the university.	UTAUT; TAM; MM
	A specific person (or group) is available for assistance with learning systems (websites) difficulties.	

Focused Immersion (FI); Heightened Enjoyment (HE); Time Dissociation (TD);
 Perceived; Usefulness (PU); Perceive Ease of Use (PEU); Facilitating Conditions (FC);
 Performance Expectancy (PE); Effort Expectancy (EE); Behavioral Intention to use the
 system (BI)

The following Table 4.5 shows a summary of models and theories from which the UTAUT is based on. TAM, MM and UTAUT have suggested multiple constructs that we are using in our scale, this is a drill down of the construct sources such that Perceive Usefulness and Perceived Ease of Use originate from the TAM, Extrinsic Motivation and Intrinsic Motivation comes from F. D. Davis et al. (1992)'s Motivational Model. In addition Venkatesh et al., (2003)'s UTAUT unifies both TAM and MM and added additional constructs in expectancy, attitude toward using technology, social influence, facilitating conditions, self efficacy and anxiety.

Table 4. 5 Main authors and their contributions in the model

Models and Theories	Constructs
Technology Acceptance Model (TAM) by Davis (1989) develops new scale with two specific variables to determine user acceptance of technology.	Perceived Usefulness Perceived Ease of Use
Motivational Model (MM) also stems from psychology to explain behavior. Davis et al. (1992) applies this model to the technology adoption and use.	Extrinsic Motivation Intrinsic Motivation
Unified Theory of Acceptance and Use of Technology Model (UTAUT) by Venkatesh et al. (2003) integrates above theories and models to measure user intention and usage on technology	Performance Expectancy Effort Expectancy Attitude toward Using Technology Social Influence Facilitating Conditions Self-Efficacy Anxiety

CHAPTER FIVE: Exploratory Research

Throughout our research period, we lived through the progression of multiple experiments with the same theoretical framework in mind. These explorations resulted in 4 articles fundamentals to designing the final experiment which we included in the appendix. Which has been to tie together 3 crucial elements of knowledge creation such as the student, the task and the artifact.

We were curious to investigate on how students learn best especially from each other, and questioned how can we create an environment that will increase engagement, immersion, and performance. In order to look at relevant constructs and obtain insight into the mechanism of learning while using the P2P, we fell on the Item Response Theory analytical method which allowed us to take a closer look at students' performance in comparison to the rest of their cohort, and to further understand the level of consistency in their knowledge.

In addition, we looked into the literature of Brain Based Learning more specifically, in topics of creativity, intelligence and emotions within immersive environments to define what is learning for students and what brings out the best of them within an immersive featured environment.

Then, we investigated on the artifact itself which consists of the P2P tool. The system was developed with the consideration of students learning in mind, and throughout the period of 3 years, we were able to elaborate, develop and improve the process of P2P. Our paper on immersive learning experience in post graduate education helped us define the P2P as an immersive learning with the consideration of traditional

learning methods such as experiential, constructivism and collaborative where all three have been incorporated within the process of P2P 's three phases activities.

Subsequently, we took a closer look at the mechanisms of knowledge processing and development pioneered by Ikujiro Nonaka, Takeuchi, & Umemoto (1996). The mechanisms following the suggest Socializing- Externalizing – Collaborating- Internalizing (SECI) with the processes of transforming student's tacit knowledge into explicit knowledge and vice versa can be done through socialization, externalization, collaboration and internalization of knowledge facilitated and orchestrated by the teacher, while using the P2P where students' knowledge was managed and organized to optimize the efficiency of targeted learning.

Overall, the three-fold conceptual framework overlap to form knowledge creation, this creates an opportunity to blend together knowledge management with technology in the means of the creation of a computer assisted learning system and allow students to engage and reach a state of flow. "Flow" being the operative word and the outcome construct studied in this research where all researchers agree that optimum learning is achieved when an individual is in a state of flow.

Flow was pioneered by (Csikszentmihalyi, 1990) who defines it as the state where an individual is fully engaged and loses track of time while engaged in an activity. In this section, we present with the results of the exploratory phase and the lessons learnt from each experiment carried throughout the thesis. This consists of a series of 4 published papers, which we summarize herein and include at the end of the dissertation in the appendix.

Paper 1 –Immersive Learning Experience

The purpose of this paper was to reveal the peer-to-peer learning platform with an attempt to get feedback from the scientific community on the P2P as a tool. We framed this process as an immersive learning experience designed by pedagogical models with experiential, constructivism, collaborative elements.

It was our first attempt in understanding the process of peer-to-peer learning through an exploratory study. Where the participants were 15 students in a Ph.D course in pedagogy. We presented the process of the three-stage activity of creating, evaluating and testing knowledge. We also identified immersive learning elements by justifying why the peer-to-peer tool follows experiential, constructivism and collaborative elements.

In the results and discussion section, we identified the number of questions generated by students and their respective quality then we identified the performance level of students taking the test in phase 3. In addition, we began to explore further the results using Item Response Theory by looking at the true proficiency level of each student in comparison to their cohort.

Through this first paper “ Immersive Learning: Using a Web-Based Learning tool in a PhD course to enhance the learning experience”, published in the Journal of Information Technology Education (Appendix D), we learnt the following lessons.

- We understood the sample size was very small and at times may not be significant for generalizations. More specifically, the PhD program is a niche segment of possible users of the peer-to-peer system. It was necessary for us to improve the research by reaching out to a larger audience in the undergraduate level and the master level.

- In terms of the P2P system, we noted a few modifications from students' feedback on the flow of the process from phase 1 to phase 3.
- We also noted modifications from the researcher's execution side in terms of time allocation for students to create questions, to submit questions and to evaluate questions.
- We noted the shortcoming of giving an online assignment where students had the option to complete the phases in one instance or leave the screen open for multiple hours.
- We noticed a lack of qualitative feedback and measurements of the process and considered implementing one in the next study.

Overall as an exploratory study, it was worthwhile to try the process with a small sample of students to identify the hurdles in measuring students' engagement level using the P2P system. In this paper, we tackled specifically two objectives, which was to identify the peer-to-peer system as an immersive tool by justifying its features with pedagogical literature and to attempt in measuring students performances and automation of a knowledge creation process. Most importantly, we confirmed that the P2P has potential for student engagement and does in fact produce knowledge. We were aware there are multiple facets not yet explored.

PEER TO PEER SYSTEM

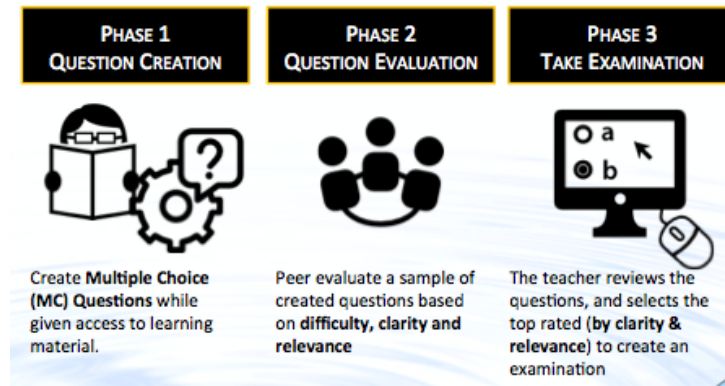

Figure 5. 1 three phase approach to the peer to peer activity

Paper 2 –Understanding of Peer to Peer Learning Using Item Response Theory

This second paper (Appendix E) is a continuation of the previous preliminary study where we further analyzed a small sample of PhD using the peer-to-peer system while taking a focus on the Item Response Theory statistical tool for further insight on the performance aspect/element of students. In order to enhance the data within this paper, we took a larger sample of 120 undergraduates students in a Marketing course to validate the Item Response Theory analysis. In this paper we elaborated on part 1 a student-by-student analysis of their performances, part 2 an item-by-item analysis of the questions generated and tested by students, part 3 an overview of the test creation process.

In Part 1, we were able to identify the proficiency level of students as well as their consistency in taking a similar test in the future through their credibility score where a score of 1 is highly consistent that they will obtain a similar performance in a similar test.

In Part 2, we look at the top questions generated by students with high quality evaluated by students. We were able to identify three types of questions, first are high

engagement questions where students who created this type of question understood their course material very well, which provoked high proficiency students to perform well while lower proficiency students made a variety of choices. Second, are types of questions that cannot discriminate high and low proficiency students given the question reflect the creators course content ambiguity. Third, are the 2 option questions where the choices were very distinct only for 2 out of 5 answer choices, allowing students to easily discard choices.

In Part 3, as an overview of the test, we found the test was informative for students who scored between 10/18 to 13/18 allowing them to answer easy question and plateau at more difficult questions. For students who performed beyond 12/18, the level of information provided by the segment of high performers was harder to detect due to the number of discriminant questions.

Overall, this paper allowed us to investigate the learning process of students with more complex statistical methods. This provided a benchmark to understanding what makes a good test and whether, through collaborative learning students can generate discriminant and information tests that are equivalent to traditional teaching.

In the process of writing paper 2, we learnt the following lessons.

1. The Item Response Theory method is very suitable for the peer to peer learning system given it can allow researchers to identify more details than classical test theory methods in an individualized level. However, it is also important to look at classical test theory methods to gain a holistic view of the data.
2. In this research attempt, we learnt the performance of students' test taking is also reflective of the question creation process.
3. The P2P does in fact provide an accurate and more representative performance outcome and can be used for assessment purposes.

This research allowed us to look at the ability of the peer to peer system to elevate the teacher-student learning experience through customized assessments of the students' knowledge acquisition level.

Paper 3 –Evidence Based Management for Learning: An Experiment

In this paper 3 (Appendix F), we addressed a very important question about the difference between traditional learning and peer to peer learning. We felt that at this point, the value added of the P2P as compared to traditional learning and in consideration of evidence-based knowledge, should be studied. Specifically, we also looked at the Evidence Based Management technique in providing empirical evidence versus theory alone in the students' learning process while using the P2P.

In this paper we also examined the theory of knowledge management pioneered by Ikujiro Nonaka et al., (1996) where they introduced the SECI Model. The SECI Model reflects a mechanism of knowledge creation where tacit knowledge transforms into explicit knowledge. In this paper we were able to map out the process of the peer to peer within the SECI Model.

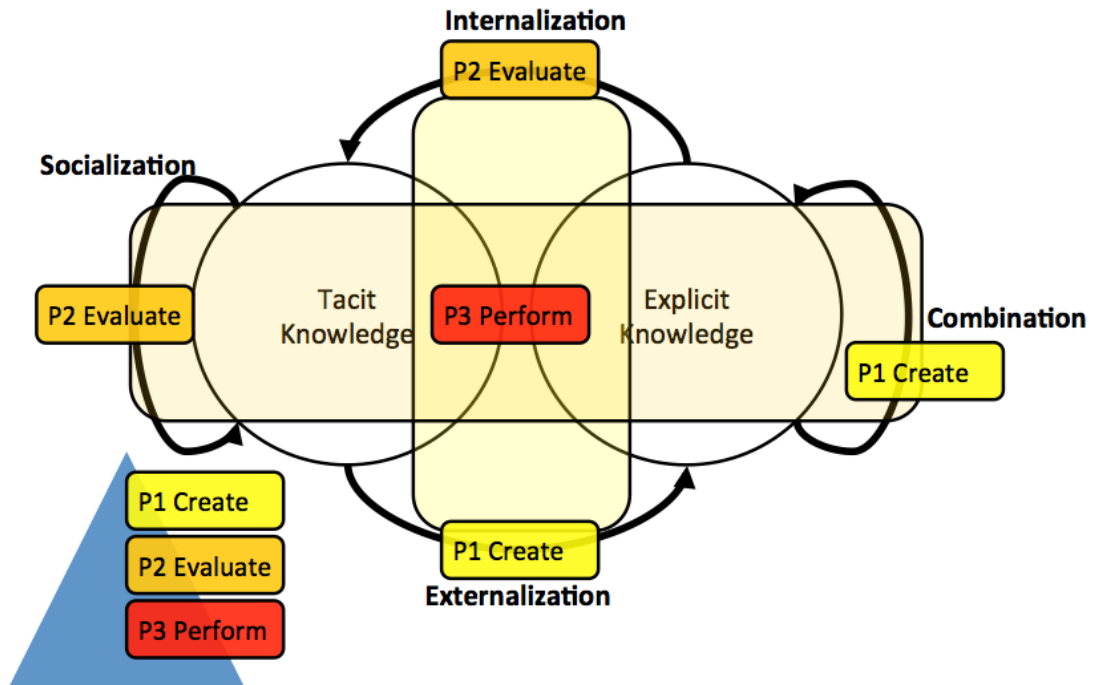

Figure 5. 2 Fitting the I. Nonaka et al. (2000)'s SECI to our 3 phase in P2P

In our experiment, we compared traditional learning vs. peer-to-peer learning. Traditional learning meant students studied course material on their own as well as with the teacher's lecture, while peer to peer learning meant student proceeded with the three-phase process of creating, evaluating and testing. We used the method of ANCOVA, where the difficulty level of each question was considered a covariate and Item Response Theory to look at significant difference between traditional and peer-to-peer learning. As a result, the peer-to-peer learning group scored higher and obtained a smaller standard deviation.

When investigating on the effects of Evidence Based Management, we took a qualitative methodology to identify the students' reading level. Our results showed, most students omitted the evidence given to them, but focused on key words to study. Overall,

this new perspective in peer to peer allowed looking at variations in teaching styles and methods.

The lessons learnt in this experiment are as follows:

- We understood the importance of capturing qualitative and quantitative results to understand not only students' performance but also their thoughts and emotions.
- We listened to students' opinion on the relevance in using peer to peer as a study tool.
- Moreover, we were able to make modifications in the peer-to-peer platform in order to enhance students' experience.
- In this paper, we investigated with first year undergraduate students, which allowed us to look at more generalization and comparison from one level of education to another.

Paper 4 –Knowledge Management IT Tool: an Investigation within a Marketing

Introductory Course

This latest research experiment (full paper in Appendix G) was conducted last with modifications within the system flow, with the consideration of a qualitative questionnaire with scales evaluating flow of engagement and ease of adaptation to technology. In addition, this experiment was controlled within a full semester of 13 weeks where the same students use the peer-to-peer system multiple times as a study tool primarily as well as a testing tool self-assessment. Hence, we were able to look at the progression in students' learning improvement over time.

In this paper, we focused on establishing the mechanism of the SECI model with the peer-to-peer tool. We investigated a common scale in technology adaptability at the instance of the midterm preparation and the final exam preparation where students were asked to use the peer-to-peer tool to help them study. Moreover, given the teacher was

also the researcher, we were able to contrast peer to peer created questions within the midterm exam mixed with teacher generated questions. Overall, our results showed there was added value in students learning preparation as repeated practice allowed them to understand course material better, hence performing better at the examination test.

We also found students adapted quickly to similarly worded questions, hence obtained a smaller standard deviation in their cohort score. When looking at the performance on teacher generated questions, because it was worded differently, students obtained a larger standard deviation in their performances. Overall, this investigation was holistic and incorporated all previous lessons learnt.

However, there is still a lot of work and research to do in this field. Through this paper, we learnt the following:

- The generalizable result obtained can say the peer-to-peer tool encourages repeated learning, which can be created with other tools as well. It is the model of learning that is most important and less the IT tool.
- The added value to the peer-to-peer tool is the thought behind its creation where we have incorporated a mechanism in knowledge creation that is intuitive and easy to use for students.
- We also learnt the interaction and responsibility of the teacher is crucial in encourage learning. This tool is a companion and not a replacement to the teaching profession, as students' generated questions need to be overseen and approved by the teacher before a test can be created.
- However, this tool adds a lot of value to the teachers' profession as it creates efficiencies in students' learning process by helping the formulation of test questions and practice questions.

CHAPTER SIX: Results & Analysis

After multiple explorations, we are now ready to consolidate all data sets to study our proposed conceptual model integrating fundamental theories of Flow (Csikszentmihalyi & Csikszentmihalyi, 1992), Technology Acceptance Model (TAM) (F. D. Davis, 1989), Unified Theory of Acceptance and Use of Technology (UTAUT) (Venkatesh et al., 2003), Motivational Model (MM) (F. D. Davis et al., 1992), Cognitive Absorption by (R. Saadé & Bahli, 2004), Person-Artifact-Task (PAT) (Finneran & Zhang, 2003), and Socialization-Externalization-Combination-Internalization (SECI) (I. Nonaka et al., 2000).

Our primary contribution consists of testing the theoretical models first, for e-collaborative immersive learning (the present context), followed by the building of an immersion model that can explain the use of collaborative technologies for immersive learning. In order to do that, we needed to break down the constructs of Flow, and identify the relationships between Flow, the immersive construct and UTAUT constructs.

In this chapter, we refine our latent constructs through factor analysis and study a final model through structural equation modeling to define the Technology Immersive Model (TIM). We start with descriptive statistics describing our participants' demographics, then we explore a portion of our data set to define factors through Exploratory Factor Analysis (EFA), and confirm these constructs with a different portion of data using Confirmatory Factor Analysis (CFA) to obtain a theory-oriented model reflecting our obtained data. Finally, we test our hypotheses and discuss our findings to conclude with our proposed theoretical model (TIM) in the context of collaborative learning.

6.1 Psychometric Properties

The following are scales used to build our questionnaire, also shown in Table 4.3 in Chapter 4. All items used in our questionnaire had been previously tested for reliability and validity, however not in a context similar to this study. The items used in this study were adapted from:

- Unified Theory of Acceptance and Use of Technology (UTAUT) (Venkatesh et al., 2003), based on Technology Acceptance Model (TAM) (F. D. Davis, 1989), Motivational Model (MM) (F. D. Davis et al., 1992)
- Cognitive Absorption Model (R. Saadé & Bahli, 2004) based on Flow of Engagement by (Csikszentmihalyi, 1990)

6.2 Descriptive Statistics

The sample consists of a total of 288 participants from 9 different ethnicities (African, Asian, European (East/Russian), European(West), Latin American, Middle Eastern, North American, Oceanian) (See Figure 6.1 and Table 6.2), 3 levels of education (junior undergraduate (1), senior undergraduate (2), and masters level (3)) (See Figure 6.3 and Table 6.4). Our sample also has a gender split of 42% female (1) and 58% male (2) (See Figure 6.2 and Table 6.3). Our sample contributes to a diversified pool of the population in the higher education allowing us to generalize our findings.

In addition, our sample of 288 are combined from 6 different peer-to-peer activity sessions held in 5 different courses (See in Table 6.1). In our study, we split the 288 participants into two portions; Group M (n=146) represents two peer-to-peer sessions in a Marketing course, which is the most consistent group using the latest iteration of the platform, questionnaire and common professor. Group O (n=142) is a combination of four other courses in project management, enterprise resources planning, and finance,

representing a good mixture of students with a variety of different professors, time slots, and semester.

Table 6. 1 List of courses from our sample of 288 participants

Course Code	Course Title	Type of Cohort
430	Enterprise Resource Planning	Undergraduate
480	Project Management - Introduction	Undergraduate
660	Project Management - Strategic	Graduate
Fina	Finance	Undergraduate
201	Marketing	Undergraduate for Non-Business Students

Demographics

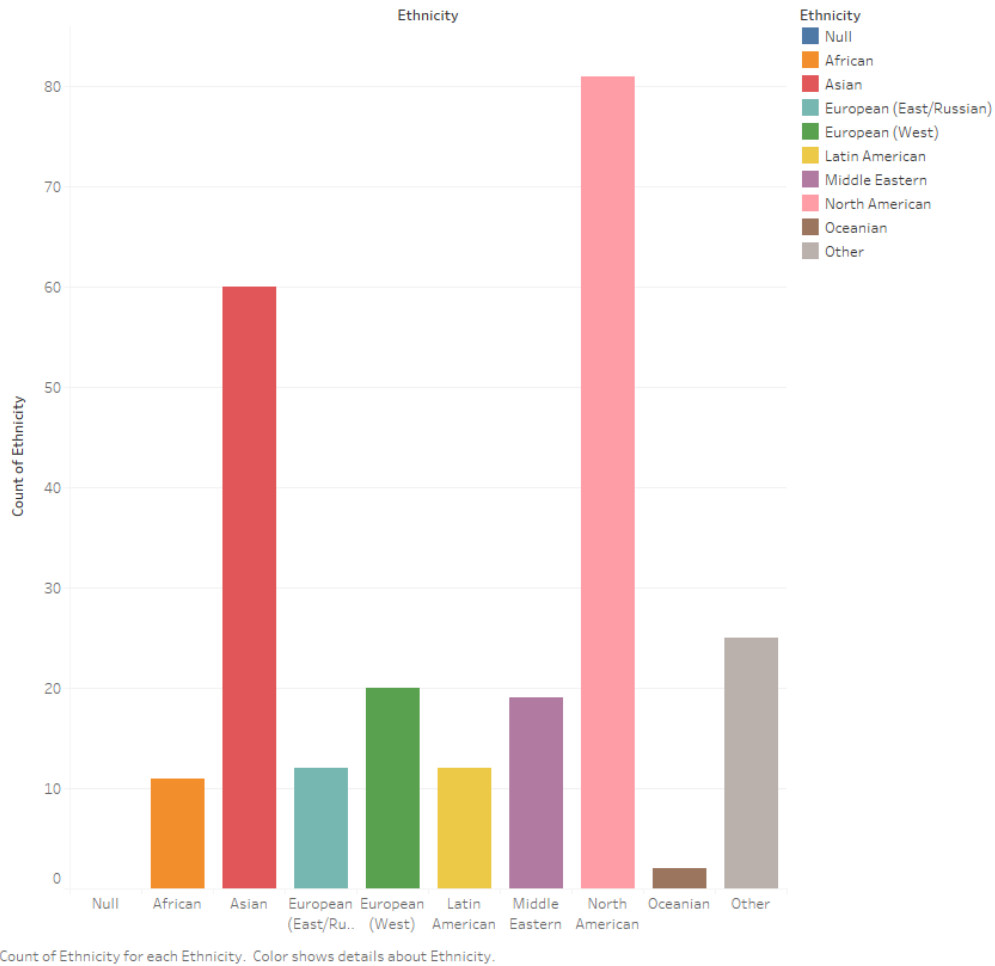

Figure 6. 1 Graph representing the diversity in ethnicity of our sample

Table 6.2 presents the distribution across gender. In this figure, ‘Group’ represents the 6 courses from which data was collected. Females are coded as 1 and Males are coded as 2. The width of the bar represents the frequency of participants.

Table 6. 2 Representation of the gender split Female (1), Male (2)

Gender

	Frequency	Percent	Valid Percent	Cumulative Percent
Valid 1	121	42.0	42.0	42.0
2	167	58.0	58.0	100.0
Total	288	100.0	100.0	

Number of Participants by Education by Group.

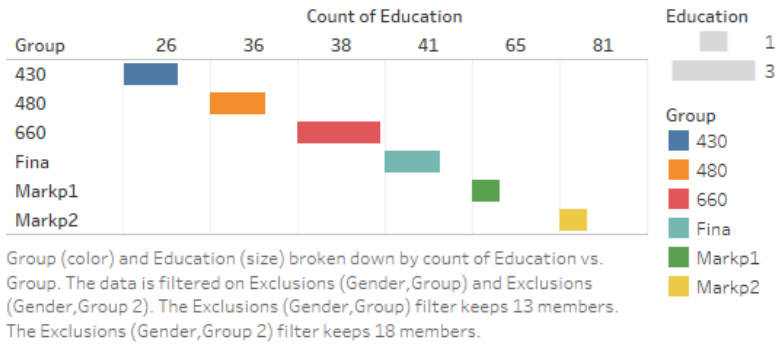

Figure 6. 2 Bar chart representing the level of education of each course.

In figure 6.3 the width of each bar represents: 1. Junior undergraduate (1st year), 2. Senior undergraduate (specialization courses), 3. Graduate level.

Table 6.3 Frequency table for each education level.

1. Junior undergraduate (1st year), 2. Senior undergraduate (specialization courses), 3. Graduate level.

Education		Frequency	Percent	Valid Percent	Cumulative Percent
Valid	1	146	50.7	50.7	50.7
	2	103	35.8	35.8	86.5
	3	39	13.5	13.5	100.0
	Total	288	100.0	100.0	

Figure 6.3 shows that number of students in each course, Course 430, 480, and 660 are senior undergraduate, while course 660, with a wider education bar is a masters level course, and Markp1 and Markp2 are junior undergraduate courses. Markp1 represents a peer to peer session held for a midterm review while Markp2 represents a peer to peer session held for a final review of the same course. Table 6.3 reveals that 50% of our

sample are from junior undergraduate, 35.8% represent senior undergraduate and 13.5% represent graduate level which is representative of higher education demographics

6.3 Statistical Analysis (EFA, CFA, SEM)

The process of our statistical analysis includes three parts as shown in Table 6.4. The first part analyzes Group M, two peer-to-peer (P2P) sessions from an undergraduate marketing course with 146 students from 40 non-business disciplines. Group M is very consistent and controlled, it is the last data collection session with a consistent professor and we used the latest implementation of the P2P tool. For this reason we felt that this sample is appropriate for the testing and validation of the items to our present context and for factor reduction exercise using Exploratory Factor Analysis (EFA) to define relevant constructs and see whether theory aligns with the data. In addition, by proceeding with the factor reduction exercise our goal would be to keep the most essential and optimum items (non-redundant) to describe the particular constructs. Once the constructs are identified, we proceed to part 2 utilizing the data from Group O, which entails a compilation of 4 different courses and including participants totaling 142 students. Group O provides a good diversity in students taught by different professors, hence would be appropriate to further validate the new constructs obtained from the EFA results of Group M.

In addition, with Group O, we conduct Confirmatory Factor Analysis (CFA) to investigate existing relationships and correlations between factors. We end part 2 by suggesting a model taking into account our statistical results and setting directions based on our theoretical framework and the literature. We are then able to present the Technology Immersive Model (TIM) with its respective hypotheses to be tested via

structural equation modeling technique. In part 3, we combine all students (n=288) to test the proposed model and its hypotheses through the analysis of Structural Equation Modeling (SEM) and follow with a discussion section on our findings.

Table 6. 4 Three-part analysis process of the scale

Part	Group	Comment	EFA	CFA	SEM
1	Group M	Factor Reduction & Factor Exploration	Yes		
2	Group O	Factor Confirmation & Relationship investigation	Yes	Yes	
3	ALL	Building from theory and obtain final model	Yes	Yes	Yes

Part 1 – Exploring our data through Exploratory Factor Analysis (EFA)

Starting with EFA, we are primarily investigating potential results that may appear in the integration of immersive computer systems alongside students’ engagement levels and their perceptions of technology (usage and acceptance). Our scale consists of items from UTAUT (Venkatesh et al., 2003) and the Cognitive Absorption scale from (R. Saadé & Bahli, 2004) from which these two scales are inspired by foundations theories from Csikszentmihalyi & Csikszentmihalyi, (1992)s' Flow of engagement, The Motivational model (MM) by F. D. Davis, (1989), Technology Acceptance Model (TAM) by F. D. Davis et al., (1992). (See Table 6.5)

Table 6.5 Description of Scale Items used in the study and their sources

Our Code	Author Coded	Description of the Question	Source
Temporal Dissociation			
TM_1	TD	Sometimes I lost track of time when I was using the P2P SYSTEM	RS&B
TM_2	TD	Time flew when I was using the P2P SYSTEM	RS&B
TM_3	TD	Most times when I got on to the P2P SYSTEM, I ended up spending more time than I had planned	RS&B
Focused Immersion			

IM_1	FI	When I was using the P2P SYSTEM, I was able to block out most other distractions	RS&B
IM_1	FI	While using the P2P SYSTEM, I was absorbed in what I was doing	RS&B
IM_1	FI	While using the P2P SYSTEM, I was immersed in the task I was performing	RS&B
Heightened Enjoyment			
EJ_1	HE	I had fun interacting with the P2P SYSTEM	RS&B
EJ_1	HE	Using the P2P SYSTEM Bored me	RS&B
EJ_1	HE	I enjoyed using the P2P SYSTEM	RS&B
Design Based items			
EF_1		Tell us about your experience with the P2P System. How satisfied are you with the quality of the outcome which you and the other party reached?	
EF_2		To what extent does the final outcome realistically reflect your objectives?	
EF_3		To what extent are you confident that the outcome is acceptable?	
EF_4		How would you describe the P2P System process you and the other party used? Efficient to Inefficient	
EF_5		How would you describe the P2P System process you and the other party used? Coordinated to Uncoordinated	
EF_6		How would you describe the P2P System process you and the other party used? Fair to Unfair	
EF_7		How would you describe the P2P System process you and the other party used? Satisfying to Unsatisfying	
Performance Expectancy			
PU_1	PE	I find the P2P Program useful.	UTAUT; TAM
PU_2	PE	Using P2P Program enables me to accomplish learning tasks more quickly.	UTAUT; TAM; RS&B
Perceived Usefulness			
PU_3	PU	Using P2P Program increases the effective use of my time in handling learning tasks/assignments.	RS&B
PU_4	PU	Using P2P Program increases the quality of my learning tasks at minimal efforts.	RS&B
Behavioral Intention to use the system			
PU_5	BI	I intend to continue using the P2P system.	UTAUT; TAM
PU_6	BI	I predict that I would use the P2P system in the future.	UTAUT; TAM
Perceive Ease of Use			
CE_1	PEU	My interactions in P2P Program is clear and understandable.	RS&B

Effort Expectancy			
CE_2	EE	I am skillful at using P2P Program.	UTAUT; TAM
CE_3	EE	Learning to use the P2P Program is easy for me.	UTAUT; TAM
CE_4	EE	I find it easy to get the P2P Program to do what I want it to do.	UTAUT; TAM
Facilitating Conditions			
CE_5	FC	I have the resources necessary to use the learning systems (websites) at the university.	UTAUT; TAM; MM
CE_6	FC	I have the knowledge necessary to use the learning systems (websites) at the university.	UTAUT; TAM; MM
CE_7		A specific person (or group) is available for assistance with learning systems (websites) difficulties.	

Focused Immersion (FI); Heightened Enjoyment (HE); Time Dissociation (TD); Perceived; Usefulness (PU); Perceive Ease of Use (PEU); Facilitating Conditions (FC); Performance Expectancy (PE); Effort Expectancy (EE); Behavioral Intention to use the system (BI)

Discussion

Looking at our Table 6.5, previous authors have developed 9 different constructs (Temporal Dissociation, Focused Immersion, Heightened Enjoyment, Performance Expectancy, Perceived Usefulness, Behavioral Intentions, Perceive Ease of Use, Effort Expectancy and Facilitating Conditions). Our reasoning behind using such scales is due to their validity (used in multiple studies across the discipline of MIS). However, we are expecting results to cater to our theoretical framework of immersive learning within an e-learning platform. Such that, constructs Behavioral Intentions, Perceive Ease of Use, Perceive Usefulness become a secondary thought while Temporal Dissociation, Heightened Enjoyment and Focused Immersions becomes more important within our analysis. We also observe that the constructs Facilitating Conditions cater very much to physical resources offered by institutions, which in our case may not apply since we are

focusing on the learning process. Moreover, we have also added additional functional items defined as Design Based that may describe the pedagogical intent of the design.

We proceed by identifying factor loadings with the raw data (Group M, n=146), with the goal of obtaining a clean pattern and reason for factor reductions if items are redundant or weak (loading below 0.5). We then proceed to testing for adequacy through Kaiser- Meyere-Olkin (KMO) measure and the Bartlett's test, convergent validity (factor loadings larger than 0.5) and discriminant validity (goodness of fit test). Our first iteration of factor loadings through a promax oblique rotation generates six factors as shown in the structural matrix in Table 6.6. The factors load well and discriminately for TM, IM, but starting at EJ, EF, PU, CE, there are sizable cross-loadings on non-intended factors. We would consider a good loading if the factor has a higher than 0.5 load, but a much lower loading in all other factors. For example, PU_1 loads high in factor 2 with .875, however loads quite high in factor 1 with .718. This means there is a lack of discrimination from one factor to another. On the other hand, TM_1, TM_2, TM_3 load relatively high in factor 6 with minimal loading in all other factors which shows these three items explain one specific construct.

Table 6.6 First iteration of EFA

Structure Matrix						
	Factor					
	1	2	3	4	5	6
TM 1	-.183	-.080	-.139	-.133	-.043	.588
TM 2	.123	.218	.210	.229	.296	.777
TM 3	.095	.130	.097	.045	.114	.766
IM 1	.264	.223	.266	.299	.704	.041
IM 2	.380	.438	.480	.435	.959	.157
IM 3	.393	.466	.498	.464	.890	.256
EJ 1	.490	.578	.592	.894	.451	.131
EJ 2	.401	.513	.419	.715	.363	-.009
EJ 3	.434	.536	.563	.966	.377	.039
EF 1	.626	.694	.832	.637	.485	.069
EF 2	.563	.701	.921	.581	.439	.080
EF 3	.653	.693	.914	.542	.439	.160
EF 4	.563	.568	.662	.445	.291	-.007
EF 5	.492	.564	.580	.463	.234	.119
EF 6	.593	.589	.640	.482	.313	-.003
EF 7	.576	.700	.698	.603	.301	-.016
PU 1	.718	.875	.719	.647	.409	.052
PU 2	.587	.836	.593	.471	.342	.174
PU 3	.574	.915	.629	.530	.383	.128
PU 4	.562	.815	.639	.546	.348	.068
PU 5	.670	.782	.703	.641	.373	.048
PU 6	.653	.759	.725	.578	.387	.093
CE 1	.843	.722	.595	.533	.340	.049
CE 2	.879	.636	.542	.491	.351	.055
CE 3	.912	.637	.529	.509	.325	.092
CE 4	.895	.650	.558	.493	.344	.053
CE 5	.811	.578	.645	.450	.360	.003
CE 6	.804	.490	.578	.322	.322	-.099
CE 7	.679	.412	.562	.337	.281	-.007

Extraction Method: Maximum Likelihood.
 Rotation Method: Promax with Kaiser Normalization.

As we proceed to do item reductions, we want to keep in mind the following specifications in order to justify why we are taking away an item:

1. The constructs need to be concise with an adequate number of items (minimum 3 items for identification purposes)
2. Each item should say something different to explain the construct, we want to ensure that each item adds value to the complexity of our latent construct
3. If loading is weak or spread, we want to have a justification as to why this item should be kept or removed.

Referring to Churchill Jr, G.A. (1979), we followed the suggested definitions to validity, reliability whereby a valid measure is when “*the differences in the observed scores reflect true differences on the characteristic one is attempting to measure and nothing else*”. A reliable measure extends to both independency of the construct, yet is comparable to the same traits. In choosing our items, we attempted to strike a balance between the two since reliability provides evidence contrary to the validity measure.

Our goal in this activity it to figure out an optimal list of items explaining our constructs, while keeping all noise out in order to utilize this scale for all technologies seeking to measure the state of immersion.

Through 11 iterations of item reduction, we present Table 6.7 with the justification of each removal as well as the final factor loading matrix in Table 6.9 and 6.10.

Table 6. 7 Justification of Item reductions.

Reductions	Item details	Justification
1. EF_5	How would you describe the P2P System process you and the other party used? Coordinated to Uncoordinated	Factor 3 has multiple items that may be redundant; therefore we are looking at keeping the top loadings. Coordinate and Efficient are close in explanation. Therefore we will keep EF_4.
2. EF_6	How would you describe the P2P System process you and the other party used? Fair to Unfair	Fairness can be explained by outcome, which has been asked in EF_2 and EF_3.
3 EF_7	How would you describe the P2P System process you and the other party used? Satisfying to Unsatisfying	Satisfaction is already repeated from item EF_1.
4 PU_5	I intend to continue using the P2P system.	Factor 2 has multiple items, with high loadings, hence they may speak of similar aspects, given PU_5 is second weakest and may be redundant from PU_2, it was removed.
5 PU_6	I predict that I would use the P2P system in the future.	PU_6 is the weakest of a strong loading construct, we believe it is redundant from all other items, hence is removed.
6 CE_7	A specific person (or group) is available for assistance with learning systems (websites) difficulties.	Factor 1 has multiple items with strong loading, CE_7 is specific and repeated from CE_5
7.PU_1	I find the P2P Program useful.	This item seems to be problematic as the loading is not fully discriminant.
8.CE_5	I have the resources necessary to use the learning systems (websites) at the university.	Based on theory, both CE_5 and CE_6 do not fit our context since they explain support in facilitating conditions
9.CE_6	I have the knowledge necessary to use the learning systems (websites) at the university.	Same reasoning as CE_5
10. EF_4	How would you describe the P2P System process you and the other party used? Efficient to Inefficient	The loading is lower than the rest but also lack discrimination between factors
11. CE_4	I find it easy to get the P2P Program to do what I want it to do.	CE_3 and CE_4 seem to speak of the same, however, we prefer the term "Learning", choosing between the two we removed CE_4

After our factor reduction exercise, we continued our investigation at the item level with the goal to optimize the survey instrument and as such questioned the representation of items PU_2, PU_3, PU_4, PU_5, PU_6 (partial item in Table 6.9 and 6.10), where the loadings seem to lack discrimination, PU_1 to PU_6 are items representing constructs of performance expectancy, perceive usefulness and behavioral intentions to use the system. We questioned whether, in this context of our peer-to-peer system, the lack of loading under 1 construct can be explained by the necessity to see the peer-to-peer system as a useful tool. We reasoned that students may not see ‘usefulness’ as a factor to encourage their use of the peer-to-peer activity and attempted to remove all PU items.

Table 6.8 Partial Items

Our Code	Author Coded	Description of the Question	Source
Performance Expectancy			
PU_1	PE	I find the P2P Program useful.	UTAUT; TAM
PU_2	PE	Using P2P Program enables me to accomplish learning tasks more quickly.	UTAUT; TAM; RS&B
Perceived Usefulness			
PU_3	PU	Using P2P Program increases the effective use of my time in handling learning tasks/assignments.	RS&B
PU_4	PU	Using P2P Program increases the quality of my learning tasks at minimal efforts.	RS&B
Behavioral Intention to use the system			
PU_5	BI	I intend to continue using the P2P system.	UTAUT; TAM
PU_6	BI	I predict that I would use the P2P system in the future.	UTAUT; TAM

As a result (Table 6.10), we were able to extract a 5-factors loading model with much better discrimination between the factors, and resulting in the removal of PU items.

We compared our loadings based on the structure matrix which showcased the bivariate correlations between variables and factors. At the same time, we also took into account the pattern matrix (Table 6.11) showcasing the partial correlations of the constructs.

Table 6. 9 Final factor loading

Structure Matrix^a

	Factor				
	1	2	3	4	5
TM_1	-.143	-.139	-.048	-.117	.578
TM_2	.149	.229	.298	.251	.778
TM_3	.123	.038	.111	.139	.771
IM_1	.269	.316	.700	.291	.061
IM_2	.371	.444	.964	.516	.168
IM_3	.390	.471	.893	.538	.263
EJ_1	.531	.901	.473	.619	.135
EJ_2	.417	.711	.387	.431	.008
EJ_3	.454	.966	.405	.562	.064
EF_1	.616	.625	.509	.835	.091
EF_2	.528	.573	.464	.936	.107
EF_3	.623	.528	.464	.928	.190
CE_1	.838	.497	.374	.595	.076
CE_2	.922	.468	.379	.562	.060
CE_3	.908	.482	.353	.549	.101

Extraction Method: Maximum Likelihood.

Rotation Method: Promax with Kaiser Normalization.

a. Groupthesis = 2

Table 6. 10 Final Factor loading - partial correlations

Pattern Matrix^a

	Factor					
	1	2	3	4	5	6
TM_1	-.090	-.020	.024	-.079	-.008	.696
TM_2	.085	.062	-.124	.038	.010	.703
TM_3	.022	-.031	.052	.055	.009	.823
IM_1	1.001	-.003	-.006	-.017	.006	-.003
IM_2	.004	-.048	-.997	.019	-.009	-.033
IM_3	.002	.059	-.826	-.009	.025	.042
EJ_1	.028	.903	-.014	-.018	-.005	.098
EJ_2	.020	.633	.000	-.002	.044	-.112
EJ_3	-.037	.902	-.014	.060	-.004	.025
EF_1	.044	.135	-.017	.729	.028	-.016
EF_2	-.012	-.017	-.013	.956	-.041	.010
EF_3	-.019	-.039	.001	.891	.061	.001
CE_1	.068	.008	.023	.147	.713	.035
CE_2	-.008	-.043	-.026	-.034	.945	-.017
CE_3	-.027	.067	-.005	-.040	.899	.003

Extraction Method: Maximum Likelihood.

Rotation Method: Oblimin with Kaiser Normalization.

a. Rotation converged in 6 iterations.

Table 6. 11 Factor Correlation Matrix

Factor Correlation Matrix

Factor	1	2	3	4	5	6
1	1.000	.372	-.556	.357	.356	-.045
2	.372	1.000	-.495	.500	.563	-.016
3	-.556	-.495	1.000	-.358	-.351	-.230
4	.357	.500	-.358	1.000	.560	.058
5	.356	.563	-.351	.560	1.000	.019
6	-.045	-.016	-.230	.058	.019	1.000

Extraction Method: Maximum Likelihood.

Rotation Method: Oblimin with Kaiser Normalization.

Now that we obtained a final set of 15 items, they were tested for Adequacy with a significant KMO of .845 score, Bartlett's test of Sphericity ($p = .000$), convergent validity with all items above .5. As for discriminant validity, we obtained a goodness of fit test of $\chi^2 = 40.694$, $p = .440$, the discrimination test in this case can reflect the nature of our items representing constructs very distinctly 5 constructs, this is a shortcoming from keeping an optimal number of items to reach a generalizable model and non-specific to any discipline. In addition, the extraction of the final 5 constructs explains 73.545% of the data, which is considered reasonably high. In cases of low explanation, it would mean our items do not explain the constructs. (See Appendix H for detailed outputs in the validation process.)

Based on this analysis, we realized that the factors did not fully load in the same way as our theoretical scales as discussed in Chapter 4. For example, our scale items (PU_1 to PU_6) from constructs of Performance Expectancy, Behavioral Intentions to use the system, Perceived Usefulness from UTAUT (Venkatesh et al., 2003) did not suit our context. Upon reflection, UTAUT was founded upon behavioral intentions as a predictor of technology usage (Thomas, Singh, & Gaffar, 2013), this means, UTAUT measures based on performances such that "This tool is useful to perform well, therefore I will use it.". This raises differences in our context such that, although our study utilizes technology, our central objective looks at the use of technological tool with the intentions of knowledge acquisition, such as "This tool engages me to learn". We can argue that our results show students' interest was on learning and possible enjoying the activity as a collaborative, competitive, and gaming rather than obtaining results to a test. On another note, our CE items were built based on UTAUT and R. Saadé & Bahli, (2004)'s

Cognitive Absorption model with constructs Perceive Ease of Use, Effort Expectancy, Facilitating Conditions (See Table 6.12) . In the process of reduction, we realized our items from Facilitating Conditions did not match our context as our platform is not university based but rather a general process to allow students learn or necessitated support in any way. Moreover, the P2P tool design was modern and responsive where students were able to use it on any device and some actually participated using their phones. Hence items from the Facilitating Conditions constructs were removed.

Table 6. 12 Partial Scale

Perceived Ease of Use		
PEU	My interactions in P2P Program is clear and understandable.	RS&B
Effort Expectancy		
EE	I am skillful at using P2P Program.	UTAUT; TAM
EE	Learning to use the P2P Program is easy for me.	UTAUT; TAM
EE	I find it easy to get the P2P Program to do what I want it to do.	UTAUT; TAM
Facilitating Conditions		
FC	I have the resources necessary to use the learning systems (websites) at the university.	UTAUT; TAM; MM
FC	I have the knowledge necessary to use the learning systems (websites) at the university.	UTAUT; TAM; MM
	A specific person (or group) is available for assistance with learning systems (websites) difficulties.	

As for the well loaded items, R. Saadé & Bahli, (2004)'s Cognitive Absorption model scale items in Temporal Dissociation, Focused Immersion and Heightened Enjoyment which were derived from the theoretical background of Flow (Csikszentmihalyi & Csikszentmihalyi, 1992) loaded the same way. We therefore renamed the respective three constructs by Timelessness (TM), Immersion (IM) and

Enjoyment (EJ) indicating the emotional state of a student during the peer-to-peer activity.

Moreover, item EF_1 to EF_3 represented design functions; hence we named this construct Functionality (EF) reflecting the extrinsic features of the platform such as the ease of navigation and process from one screen to another. Finally, items CE_1 to CE_3 is a combination of Perceive Ease of Use and Effort Expectancy, which we renamed the whole as Cognitive Expectancy (CE) indicating the ability of a student to recognize the usability of the technology and compared to their expectancies of the technology.

Based on our EFA analysis, we narrowed down to obtain five constructs as shown in Table 6.13 with 3 items for each construct. These constructs were tested for reliability and validity for the total of 15 items.

1. Timelessness (TM), defined as the feeling of losing track of time as students immerse in their task.
2. Immersion (IM), viewed as the condition for entering the state of flow whereby students experience a heightened level of engagement.
3. Enjoyment (EJ), an intrinsic motivator and an outcome of the student's experience, such that they feel happy about what they are doing and want to do the task.
4. Functionality (EF) represents the perceived utility of the collaborative tool, which includes ease of use, process, hedonic qualities etc... This construct may be viewed as the student's quality of experience as a result of the design of the tool including its embedded pedagogy.
5. Cognitive Expectancy (CE) provide the sense of being equipped with personal resources and provided support to using the tool, as well as the willingness to adapt to the learning tool. This construct includes items from TAM and UTAUT. By analysing these items in this construct, we find an interesting common thread: that the tool influences cognition which may include anxiety, worry, affect, effort to use the interface and more.

Our EFA analysis resulted in a concise 15 items, 5 constructs scale that we foresee to be explanatory of our theoretical framework of immersive learning. The 5 constructs chosen based on our data set are representative of characteristics in the knowledge acquisition process whereby the feeling of losing track of time, the state of full engagement and the intrinsic motivation of enjoyment seem to be reflective of results obtained from a good learning experience (our Student pillar in the PAT model). On the other hand, constructs Functionality and Cognitive Expectancy tap into the preliminary pedagogical design allowing individuals to go through the Task represented by the Artifact.

Table 6. 13 Full list of scales after factor reduction

Construct	Item Code	Item	Cronbach Alpha
Timelessness	TM_1	Sometimes I lost track of time when I was using the P2P SYSTEM	0.733
	TM_2	Time flew when I was using the P2P SYSTEM	
	TM_3	Most times when I got on to the P2P SYSTEM, I ended up spending more time than I had planned	
Immersion	IM_1	When I was using the P2P SYSTEM I was able to block out most other distractions	0.881
	IM_2	While using the P2P SYSTEM, I was absorbed in what I was doing	
	IM_3	While using the P2P SYSTEM, I was immersed in the task I was performing	
Enjoyment	EJ_1	I had fun interacting with the P2P SYSTEM	0.886
	EJ_2	Using the P2P SYSTEM Bored me	
	EJ_3	I enjoyed using the P2P SYSTEM	
Functionality	EF_1	Tell us about your experience with the P2P System. How satisfied are you with the quality of the outcome, which you and the other party reached?	0.924
	EF_2	To what extent does the final outcome realistically reflect your objectives?	
	EF_3	To what extent are you confident that the outcome is acceptable?	
Cognitive Expectancy	CE_1	My interactions in P2P Program are clear and understandable.	0.918
	CE_2	I am skillful at using P2P Program.	
	CE_3	Learning to use the P2P Program is easy for me.	

Scale Labels: 1- Strongly disagree, 4- Neutral, 7 Strongly Agree.

Part 2 – Confirmatory Factor Analysis (CFA)

Our next step is to investigate any relationships and correlations between the 5 constructs through CFA. Based on the analytical strategy elaborated above, we now use our Group O, a sample of 142 students from 4 different courses. It is a compilation of multiple cohorts learning different subjects (Enterprise Resource Planning, Project Management, Finance), from different levels of education (Masters and Undergraduate specialization). Our rationale is to use a diverse group of participants to confirm the relationships within our model.

We start with the 15 items selected from our Part 1 analysis using EFA. All 15 items were tested for Adequacy (KMO = .818 score, Bartlett's $p=0.000$), Convergent validity ($> .5$ for all factor loadings) with the exception of IM_1, which loaded (.466) and which we will keep for the analysis because we find it important to maintain 3 items to the construct and that it is relatively close to our rejection limit of 0.5 (See Appendix I for detailed graphs on validations).

Similarly to Part 1, the extraction score of the items explaining our factors is 71.809%, which is considered reasonably high. We tested for configural and metric invariance tests by taking into account gender (Male (coded 2), Female (coded 1)). We tested for reliability (Composite Reliability CR > 0.7), Average Variance Extracted (AVE > 0.5), Maximum Shared Variance (MSV $< AVE$). Analysis for each construct yield no validity concerns (See Appendix I for detailed tables on validation).

We obtain a model with a CFI of 0.936 and RMSEA of 0.086, considered a moderate model based on Hu & Bentler (1999) cut off value and interpretations. Moreover, the $\chi^2 = 163.979$, $p=.000$ indicating the model is not a perfect fit, however with other indices is

an acceptable model. See Figure 6.5 for Amos Output of the model with 5 constructs and Table 6.14 and Table 6.15 for the summary of correlations between constructs.

Figure 6. 3 CFA Model of 5 constructs

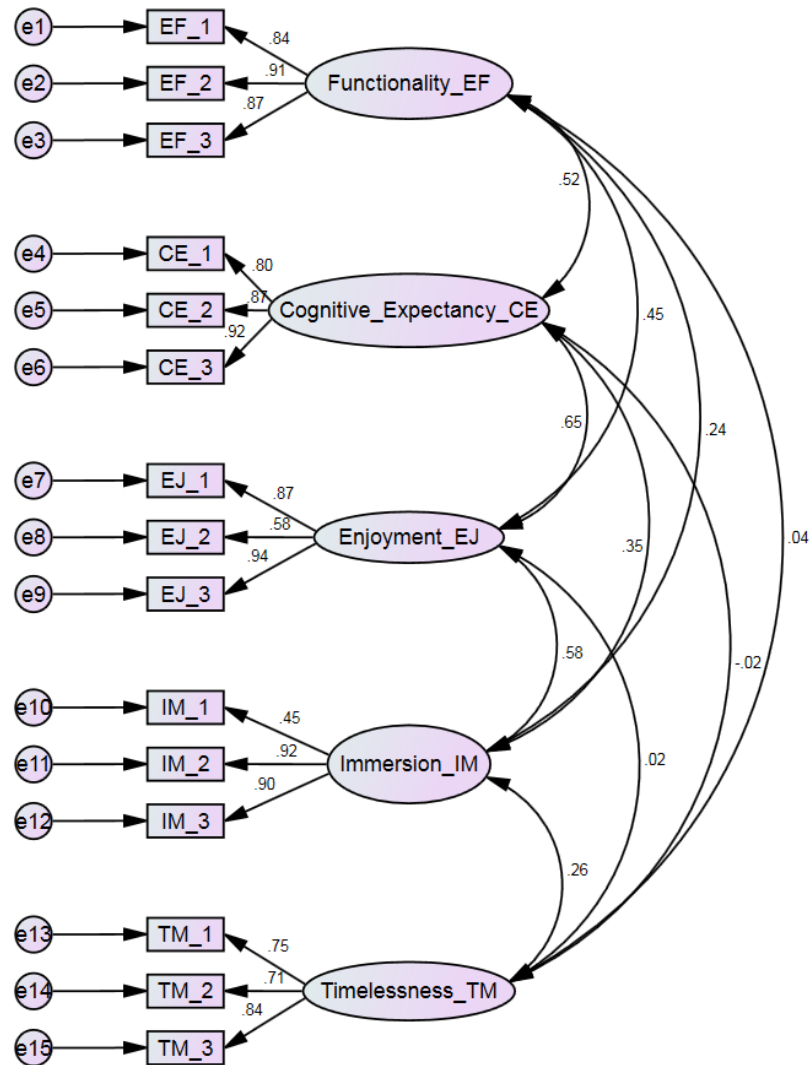

Table 6. 14 Summary of Covariances between Constructs

	EF	CE	EJ	IM	TM
EF		.753***	.714***	.186*	.058
CE			1.05***	.284**	-0.032
EJ				.507***	0.038
IM					.219*
TM					

Table 6. 15 Summary of Correlations between Constructs

	EF	CE	EJ	IM	TM
EF		.522	.454	.240	.039
CE			.649	.355	-.020
EJ				.581	.022
IM					.262
TM					

Looking at Table 6.13, Functionality has a strong interaction with Cognitive Expectancy and Enjoyment and a significant interaction with Immersion. Functionality, which is related to the design of the P2P tool represents a student’s cognitive effort as a result of using the tool. A good (efficient and effective) design that is easy to use can be enjoyable.

Cognitive Expectancy has a strong interaction with Enjoyment as well as Immersion. If the system is easy to use and satisfies the expectation of the student, it may lower the level of anxiety, which can allow an enhancement in the state of Enjoyment and allow student to achieve the state of Immersion.

Enjoyment has a strong interaction with Immersion, which can mean if students enjoy the task, they would reach a state of immersion. Immersion interacts well with all (Enjoyment, Cognitive Expectancy), including Timelessness and Functionality. Specific to Immersion and Timelessness, when a student reaches the state of Immersion, they may also reach the state of losing track of time (Timelessness).

We also observe the lack of interaction between Timelessness and Cognitive Expectancy, Enjoyment and Functionality, which by theory makes sense such as Functionality alone, Cognitive Expectancy alone may not directly allow a student to

reach the state of timelessness. As for the interaction between Timelessness and Enjoyment, we would be curious to see perhaps it is by passing through the state of Immersion that we reach Timelessness.

Building from our Integrated Knowledge Acquisition Model (IKAM) introduced in Chapter 3, we constructed a tool taking into consideration the 3 pillars modified model from PAT (Finneran & Zhang, 2003) renamed as Student -Artifact -Task , executed through the mechanism of the SECI Model (I. Nonaka et al., 2000) translated through a 3 steps process of create-evaluate-perform to achieve a strategy in pedagogy through learning goals and yielding results with student performances. In this chapter, we are now justifying and discovering a scale appropriate to measure the IKAM. We understand, knowledge acquisition in the context of immersion starts from a technology design (functionality) with which IKAM components have been incorporated into. The functionality of a tool then interacts with the cognitive expectancies of students to heighten their motivation level (enjoyment) leading to a state of immersion, such as timelessness.

With this logic, we can therefore break these interactions into three primary causal components (as shown in Figure 6.6) namely Design, Experience, and Flow. This represents a mechanism whereby a process leading to the state of flow starts with the pedagogical design influencing motivational constructs and achieves the state of immersion, which then achieves timelessness. We are drawing out our model and complementing the logic of directions based on theory, however, our proposed model in this case is data driven by our part 1 and part 2 analysis. Of course, there is still a lot to argue about in terms of direction, for example, when someone engages to the state of

immersion, they may then feel as if they lost track of time, hence we can justify Immersion affecting Timelessness. Also there is the possibility to be immersed but not losing track of time. However, the opposite can also be argued, such that, if you are losing track of time because you are enjoyment the activity, it means you have reach an automatic state of immersion. For the scope of our study, we will focus on building the model based on the statistics found, which in this case indicates Immersion has a direct effect towards Timelessness.

On the other hand, we can speak about the interaction between Functionality and Cognitive Expectancy. If the design (Functionality) is hard to use, it can then affect a student’s Cognitive Expectancy negatively such as provoking anxiety, stress and more. We therefore argue the direction of Functionality toward Cognitive Expectancy and not the opposite. With this in mind, we present our model made of 5 constructs in Figure 6.6 and 7 hypotheses.

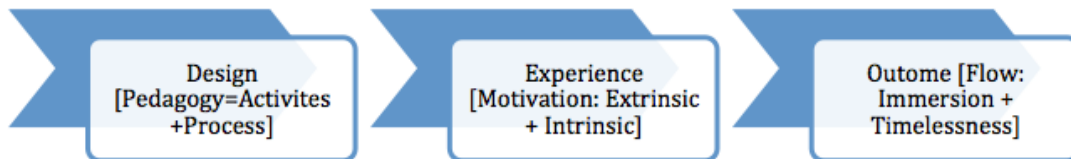

Figure 6. 4 Flow of constructs based on theory

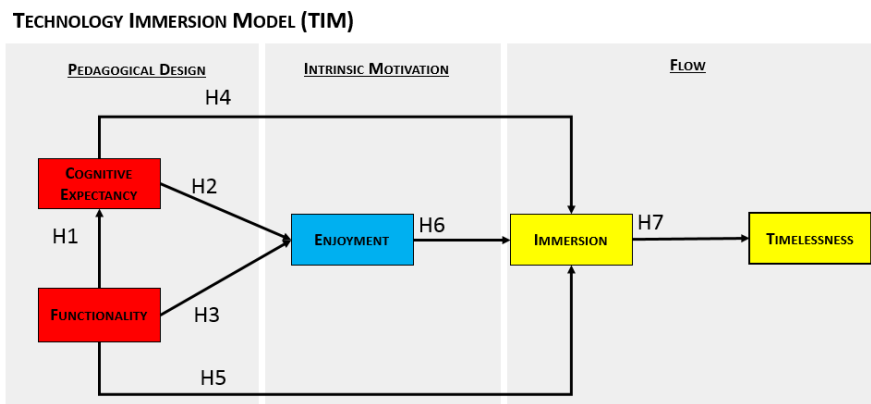

Figure 6.5 Technology Immersive Model (TIM) with hypotheses to be tested

We look at the following hypotheses to further understand whether our dataset follows our rationale about the theory based on Flow, Cognitive Absorption and the use of technology.

A student may have certain expectation on their learning process, thus a well-designed tool achieves their expectancies and allows them to proceed towards acquiring knowledge. (Amsel, 1962) questioned in this study “Why does successive non reward result in extinction?” when he mentioned the misalignment between reward and Cognitive expectancy causing frustrations. Hence, we want to test whether the functionalities causes a positive effect on cognitive expectancy.

- **Hypothesis 1:** Functionality is positively related to Cognitive Expectancy.

Doménech-Betoret, Abellán-Roselló, & Gómez-Artiga, (2017) study looked at the relationship between academic self-efficacy, student satisfaction where they found results suggesting students’ academic self-efficacy affect student satisfaction indirectly by fulfilling the latent variable of expectancy-value beliefs. Doménech-Betoret et al., (2017)’s study in Spanish secondary education can guide the direction of our construct where we propose that students’ result in enjoyment (satisfaction) when their cognitive expectancies are fulfilled.

- **Hypothesis 2:** Cognitive Expectancy is positively related to Enjoyment

In the case of wearable technologies, the term user experience is widely used to express a good design elicits enjoyment and excitement as Ho, (2017) elaborates on the emotional concerns in user experience which guides us towards the reasoning of our hypotheses

relating to enjoyment. In our context, the construct of functionality not only looks at the tool's ease of use but the pedagogical strategies behind the tool, are the functions contributing to knowledge acquisition? And how does one enhance knowledge acquisition? we hope it is through the state of enjoyment which leads to immersion, which leads to flow. Hence, we propose Hypothesis 3 to Hypothesis 6 as we argued that Functionality can explain Cognitive Expectancy which then explains Enjoyment.

- **Hypothesis 3:** Functionality is positively related to Enjoyment
- **Hypothesis 4:** Cognitive Expectancy is positively related to Immersion
- **Hypothesis 5:** Functionality is positively related to Immersion
- **Hypothesis 6:** Enjoyment is positively related to Immersion

Finally, based on Csikszentmihalyi & Csikszentmihalyi, (1992)'s optimal experience, the state of full engagement is entering the state of complete immersion in an activity.

Finneran & Zhang, (2003) also presented the Person-Artifact-Task (PAT) model leading to the state of immersion. Experiencing flow includes an important component which is feeling timelessness, a distorted sense of time when someone is focused on the present.

We therefore want to test the interaction from the state of Immersion to the outcome of reaching a state of timelessness.

Hypothesis 7: Immersion is positively related to Timelessness

We end part 2 of our analysis with a proposed Technology Immersion Model (TIM) measuring our design components in our Integration Knowledge Acquisition Model (IKAM) and questioning on 7 hypotheses directing the logical flow based on theory. In the next part, we conduct Structural Equation Model (SEM) to test these hypotheses.

Part 3 – Structural Equation Modeling (SEM) – Model testing

Our last step considers our entire sample (n=288) from both Groups M and O in order to test our suggested model shown in part 2, Figure 6.6 using SEM. We reason the use of the entire sample in order to look at an overview of 3 levels of educations and 6 cohorts reaching a level of generalizability. We first check for influential values and outliers by looking at the Cook's D plots. Plot # 1 we defined Immersion as the Dependent Variable (DV), while all others as Independent Variables (IV), plot # 2 we defined Timelessness as the DV and all others as IV have been plotting. As a result of our validation process, none of the elements exceeds a Cook's Distance of above 1, hence they all fit within the scope of the group. In addition, we also tested for multicollinearity, no VIFs exceed 10, and hence all constructs explain something new and are not redundant from one construct to another. Our analysis approach followed the suggestions of Anderson, J. C., & Gerbing, D. W. (1988) and Bagozzi, R. P., & Yi, Y. (1988). (See Appendix J for validation procedures of SEM). We then moved along with the hypotheses constructed from part 2 and obtained the results to our 7 hypotheses Figure 6.8 and Figure 6.9.

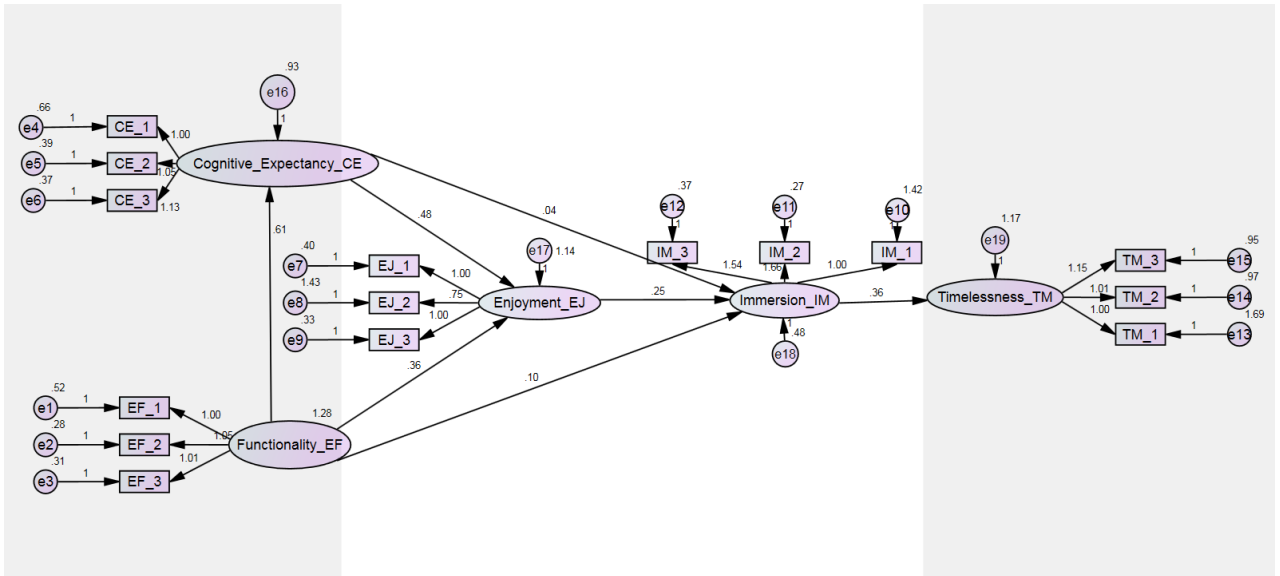

Figure 6. 6 Final Model AMOS Output

TECHNOLOGY IMMERSION MODEL (TIM)

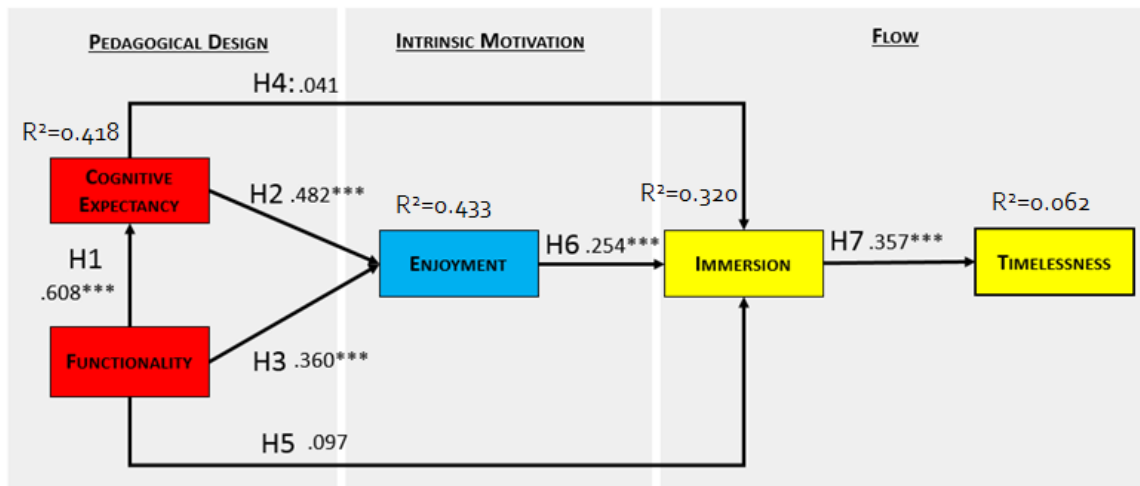

Figure 6. 7 Technology Immersive Model (TIM) with results

Our results solidify our understanding of the literature, such that the direct impact from pedagogical/system design to intrinsic motivation to flow makes sense and is validated, confirming our theoretical development. The logical flow is significant. Moreover, our reasoning between functionality and cognitive expectancy is also reached with a coefficient of .608*** and a strong relationship. In other words, we can say the

functionality triggers cognitive expectancy before the rest of the process occurs, hence it is important to have a solid pedagogical design meeting the expectations of the users and learners.

Starting with pedagogical design, both Functionality (EF) and Cognitive Expectancy (CE) significantly explain Enjoyment (EJ) with respectively coefficients of .360*** and .482***. As for the relationships from Cognitive Expectancy (CE) and Functionality (EF) explaining Immersion (IM) showed no significance, which can be reasoned that it may be too premature and may be mediated by the state of Enjoyment (EJ) before reaching Immersion (IM). We find and confirm that the state of Enjoyment (EJ) positively relates to the state of Immersion (IM) with a coefficient of .254***, which then explains the state of Timelessness (TM) with a coefficient of .357***. Overall, the results make a lot of sense, give this model was created by data, and the relationships were assigned through our understanding of the theory. Overall, the model yield a CFI of .964, and RMSEA of .065 which is considered moderate and acceptable as per Hu & Bentler, (1999). Moreover, our AGFI is 0.888 acceptable favoring parsimony, NFI of 0.937 indicating the model of interest improves the fit by 93.7% relative to the null model Overall our indices signify a compelling model and consistent with the CAB Framework.

In addition, we also ran the comparison between Male and Female (See Figure 6.9). For Male, it seems Cognitive Expectancy (CE) and Functionality (EF) both have a strong positive relationship with Enjoyment (EJ). Most interestingly, there shows a large difference in gender for the relationship from Immersion (IM) to Timelessness (TM). Males achieve the state of Timelessness (TM) when they arrive to the state of Immersion (IM), however Females, although they experience Immersion (IM), does not necessarily

achieve the state of Timelessness (TM). This becomes a great finding for future research to investigate further on gender differences and their sensitivity to each state of flow.

In Table 6.14 is the summary showcasing the hypothesis results of our analysis. 5 out of the 7 hypotheses were strong and supported, while H4 Cognitive Expectancy and Immersion as well as H5 Functionality and Immersion were not supported. It is indicative to say that going from the pedagogical design of an immersion system, the individual must experience Enjoyment which then leads to Immersion. In this case, Enjoyment becomes a moderator between design and Immersion. In Table 6.17 we observed a few differences between genders, such that Females do not experience Timelessness when achieving Immersion. This becomes an interesting point to analyze in the future by looking deeper into the role of time.

Table 6. 16 Summary of Hypotheses results of our analysis

Hypothesis	Strong	Supported	Relationships
H1	Yes	Yes	EF → CE
H2	Yes	Yes	CE → EJ
H3	Yes	Yes	EF → EJ
H4	No	No	CE → IM
H5	No	No	EF → IM
H6	Yes	Yes	EJ → IM
H7	Yes	Yes	IM→TM

TECHNOLOGY IMMERSION MODEL (TIM)_GENDER

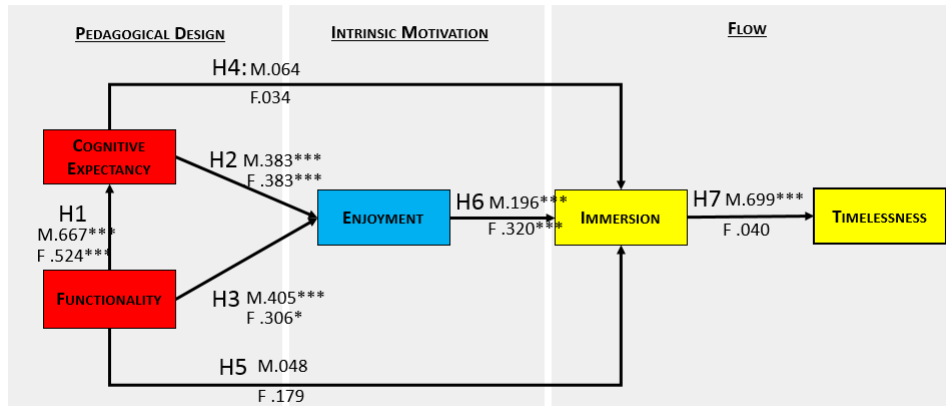

* : p < 0.05; ** : p < 0.01 ; *** : p < 0.001

Figure 6. 8 Gender split results for TIM

Table 6 . 17 Summary of Hypotheses results split by gender of our analysis

Male

Hypothesis	Strong	Supported	Relationships
H1	Yes	Yes	EF → CE
H2	Yes	Yes	CE → EJ
H3	Yes	Yes	EF → EJ
H4	No	No	CE → IM
H5	No	No	EF → IM
H6	Yes	Yes	EJ → IM
H7	Yes	Yes	IM → TM

Female

Hypothesis	Strong	Supported	Relationships
H1	Yes	Yes	EF → CE
H2	Yes	Yes	CE → EJ
H3	Less	Yes	EF → EJ
H4	No	No	CE → IM
H5	No	No	EF → IM
H6	Yes	Yes	EJ → IM
H7	No	Yes	IM → TM

CHAPTER SEVEN: Conclusion

7.1 Key Findings

To summarize our dissertation, we follow with our high level key findings.

Within the scope of knowledge acquisition and a data collection process of over 3 years in a diversified environment conclusive to generalizability, we learnt many lessons from writing our 4 papers (Chapter 5), which then allowed us to conduct a controlled study in order to analyze and develop our Technology Immersive Model (TIM).

Within our exploratory papers we learnt about Time and Performance where we studied students' performance and their time of completion, results showed that we can obtain an optimal time of learning and performance does not necessarily increase when more time is given.

On the other hand, while studying with our collaborative tool, we had the opportunity to speak to students and users to understand the functionality and design aspect of the user interface. We were also able to analyze the quality of questions created by students and confirm that the peer-to-peer systems has the ability to generate questions at the same level as traditional teachers questions with the supervision of the teacher. In another instance, we explored evidence based management, a method used in case studies when students are provided data allowing them to study theory, we conclude that very often, in learning, students focus on keywords and not on the process of leaning.

In our second part of the analysis, we conducted a controlled set of experiments with which we developed TIM (Chapter 6). Our validation process failed to comply to theoretical constructs as per the UTAUT (Venkatesh et al., 2003) and the Cognitive

Absorption scale from (R. Saadé & Bahli, 2004), but rather discovered a better fitting set of constructs tailored to Immersive learning when items from theories of MIS loaded under different factors allowing us to reveal 5 constructs (Functionality, Cognitive Expectancy, Enjoyment , Immersion, and Timelessness). With the obtained constructs, we developed TIM as an instrument allowing all researchers in MIS who have an interest in developing or have already developed a tool to measure the state of immersion and the level of knowledge acquisition. As we have taken the theoretical path of Design-Motivation- Flow (state of engagement) into account.

Finally, our 7 hypotheses were identified, with 5 supported and allowing us to conclude that enjoyment acts as a moderator.

7.2 Overview of our study

Our dissertation presents the results of a study on collaboration using a web-based tool for the purpose of knowledge acquisition and learning through an immersive experience. This dissertation first reviewed the body of knowledge and found that although many have studied immersive environments, most of those studies were in the gaming context. In the context of this study, very few have addressed the subject while there is a lack of empirical work found. The elements of the context of the study include:

The development of a web-based collaborative tool with a response design that works on any technology device and platform (tablets, mobile, computers).

Pedagogical design embedded in the tool (although the study of the design is outside the scope of this dissertation), it includes activities such as creating knowledge, evaluating knowledge and assessing knowledge. The process is defined in 3 phases

taking into account Bloom's learning goals levels that allows students to experience various learning depths.

Our data collection was diversified across different types of courses (different areas such as marketing, finance, business technology, project management, enterprise resource planning, pedagogy, management information systems), different levels of the course such as Ph.D level, Masters level, Undergraduate level. The experiments were held during different semesters (Fall, Winter, Summer) that lasted for a period of over 3 years. Moreover, the demographics are also diversified in languages, equal distributions of gender, varied ethnic backgrounds, differentiating part-time and full-time studies and filtered by computer experience.

In addition, our experiments were carried both in virtual and face-to-face environments allowing generalizability to cater hybrid, traditional and online learning.

Having positioned the research at the intersection between knowledge management, immersive environments and learning we first explored the effectiveness of this learning tool to process knowledge for student learning. This part of the analysis was based on Nonaka's SECI model elaborated in previous chapters and whose knowledge processing mechanisms were part of the design of the tool. Since knowledge creation was analyzed, further investigation was done to assess the tool's design ability to produce an experience of immersion in the learning process – as well studies psychological construct based on the theory of flow whereby maximum learning can occur. Consequently, existing theories of TAM, UTAUT and Flow were utilized to investigate the immersive learning potential of the collaborative tool. Our ultimate goal was to identify an

immersive learning model to explain student experience while using information technologies for learning.

To that effect, we first tested the validated constructs and items from the above-mentioned theories. In that process, we engaged in a factor reduction exercise resulting in the following conclusions:

1. The theoretical models do not apply to our context of collaborative learning environments, and
2. EFA produce a different set of factors – namely 5 factors

As a result, we went back to the theory of flow and explained a design-experience-immersive theoretical model leading to what we called the "Technology Immersive Model" (TIM). Finally, we tested the model using structural equation modeling. The empirical results show strong support to the theoretical model. This new TIM now needs to be utilized under various contexts and scenarios to test its explanatory powers of immersive learning environments.

7.3 Putting it all together (A research roadmap)

This study draws from a number of theories in technology acceptance, knowledge management and flow experience, and entailed a number of steps leading to a proposed theoretical model (Technology Immersive Model) to explain immersive learning using information technologies. It is worth it at this point to go over the steps as a roadmap of this research:

1. Understanding the theoretical background of the field of knowledge acquisition defined by knowledge management (I. Nonaka et al., 2000), technology models (Technology Acceptance Model (TAM) (F. D. Davis, 1989), Unified Theory of Acceptance and Use of Technology (UTAUT) (Venkatesh et al., 2003),

Motivational Model (MM) (F. D. Davis et al., 1992), Saadé, R., & Bahli, B. (2005)'s Model on cognitive absorption.

2. Understanding current research relating to immersion learning and identifying a gap in the definition of what is an immersive environment. Inspiration from Van Schaik et al., (2012), Finneran & Zhang (2003), Jackson & Marsh (1996)- Person-Artifact-Task (PAT) to build on their work and establish an immersive framework incorporating technology and Csikszentmihalyi & Csikszentmihalyi (1992)'s flow of engagement.
3. Proceed with an exploratory design of an information technology tool called P2P, a design taking into account our theoretical background.
4. Data collection by investigating and running P2P in a variety of courses, such as ERP, PM, Marketing, Finance, the 3 different educational levels (Doctoral, Masters, Undergraduate 1st, 2nd and 3rd, years) with business and non-business up to 40 different disciplines.
5. Continued changes and development of the procedure while exploring different topics related to our dissertation scope such as investigating on the Item Response Theory analysis method, the Evidence Based Management comparisons (highly used in the medical field and taught as a case based method), comparisons between tradition learning and our P2P learning.
6. Presentations to 4 different conferences and on-going publications in order to receive valuable feedback from judges and peers. ISI (3 times), ASAC (1 time), AGRE (2 times).
7. Aggregation of all data sets, keeping the latest more consistent data (n=288) to run a data driven model through the analysis in factor analysis and structural equation modelling.
8. Suggesting the Technology Immersive Model (TIM) , a measurement of the immersion state based on previous theoretical model.
9. Offering the Integrated Knowledge Acquisition Model (IKAM), a toolkit to create immersion technologies for knowledge acquisition and measuring the IKAM through TIM.

7.4 Limitations

On the overview of our dissertation, there were limitations to high level reasoning. The approaches taken in our experiments and our explorations were not exclusive such that there are multiple methods but we chose one every time.

When building our model, we chose to define the model based on data through the procedure of CFA. The model could have been explored by determining theory.

Within our statistical analysis, the interpretation of our factors were based on our knowledge of the field and our interpretation of the literature review. We named our constructs Functionality, Cognitive Expectancy, Enjoyment, Immersion Timeless. One can argue the constructs' naming should be different.

Our interpretation of IKAM, which in our context explored a 3 steps execution (Create-Evaluate-Perform) can be different depending on the scenario and the context of the tool design. This is only one combination. There are be many changes within our Integrated Knowledge Acquisition model.

Moreover, our sample is limited to the groups we evaluated, although generalization can be advocated and resulted in a proper model, generalization is yet to be polished in broad fields of education and in corporations.

Overall, our limitations to this research are also opportunities for researcher to investigate on. We have provided a starting point, however there is much more research to be done in this field and this topic.

7.5 Future Research

Throughout explorations and multiple brainstorming periods, researchers have multiple opportunities to continue investigating on the topics alluded to in our dissertation.

Researcher can seek to elaborate further on the technology immersive model (TIM) proposed by investigating on more items explaining different perspectives of each construct (Functionality, Cognitive Expectancy, Enjoyment, Immersion and Timelessness).

Researchers can build on refining the definitions of each components with IKAM by testing IKAM on their existing tool or new creations. They can also suggest different versions of IKAM depending on the types of evaluations (Multiple Choice, or Essay, Quantitative or Qualitative).

Our experiments tested a diverse population, although more experiments can be carried along with different subjects and differentiations between gender, culture, ethnicities, teaching philosophies and so on.

In our dissertation, we also started the benchmarking procedure whereby the level of engagement is analyze. Future research can include the exploration of further analytics such as testing the granularity of time, benchmarking the intensity of emotions and immersion.

Further research can explore Item Response Theory as an analytical tool in personalized learning to look at customizing the level of difficulty based on previous attempts (determining the skill level of the student).

Overall, this dissertation is a starting point to many topics of research in relations to the field of cognitive neuroscience meets analytics.

7.6 Implications

Our dissertation contributes to both researchers and practitioners who seek to explore knowledge acquisition in implementing technology tools for learning and training. We modelled IKAM and TIM to be generalizable throughout different fields, ethnicities allowing anyone looking into developing an immersive tool a checklist of the components needed and a verification scale on the immersion level of students using their tool. As we mentioned in Chapter 1, knowledge management contributed enormously to all fields, mainly in business. Our era now builds on large amounts of data to make informed decisions while knowledge management with technology fosters this shift in how information is processed and how knowledge is processed.

Our world today is different from the world we lived in 50 years ago, researchers continue to seek for innovations and refinement of theories, however a common field of interest has been in data analytics and technology because these two components are now more accessible and larger in scale. For practitioners in business, they seek for continuous education of their employees and the development of particular skills that can improve their organizations. More often, employees are learning as they go given a highly competitive market. For educators, teaching is no longer the same, students have shorter attention spans and more distractions. Educators have a need to innovate in their approaches to engage students to understand content. For students, testing has become somewhat robotic and highly stressful as the job market becomes more competitive, students gain the pressure to study more at a faster pace. But let's take a pause...

It seems as if the world is moving so fast that we can quickly lose control, if we were to reflect on the meaning of this dissertation, it would be to create a connection between educators and students, students to students, employers and their employees, researchers and practioners. Our dissertation centers around learning – truly enjoying the process of knowledge acquisition and experiencing immersion and timelessness.

Therefore we would like to present the implications of our research to each stakeholder.

Implications for researchers:

- Continue to develop IKAM in the context of different tools
- Continue to test TIM and refine TIM
- Develop and innovate tool that truly focuses on knowledge acquisition
- Suggest additional models that complement this train of thought
- Connect with practioners to test the tools that can impact the end users

Implications for practioners in business:

- Allow employee to train with Immersive tool that engage knowledge creation
- Foster collaboration with the community through brainstorming sessions
- Reinforce skills and knowledge and strategic align the organization's mission
- Invest in employee's education and embrace employee's knowledge
- Engage in building multidisciplinary workplaces and exchange ideas

Implications for educators:

- Engage in tools that motivate students to focus on the learning process and less on the performances.
- Connect with students by incorporating their creations in the testing process.
- Understand students' skill levels based on their inputs
- Enhance learning outcomes as learners retain and understand the material
- Embrace IKAM and TIM in teaching styles from experiential, to blended (traditional & online) learning.

Implications for students:

- Enter a distraction free environment for a period of time.
- Enjoy the process of learning, rather than the stress of performing.
- Build on the enjoyment of an activity rather than the torture of examinations.
- Take a step back and connect with the teachers by showcasing new creations and participating within the process of teaching.
- Learn from peers' knowledge and increase cognitive flexibility

7.7 Final Remarks

Overall, the world of MIS/BTM has always been rich in innovation. Many theories were built a long time ago, and foundations have been invented many decades ago. Today, the main difference is a faster pace in data gathering and the accessibility of 85% of the world having internet and access to technology. As mentioned (Uganda), the purpose of technology needs to come back to its core which is effectiveness, in our case, the effectiveness of learning. We believe our contribution to the MIS/BTM field can continue the elevated interest in using technological tool in learning without forgetting all foundational theories and defining what truly contributes to learning such as knowledge acquisition. Our dissertation fills the gap in current research and will become obsolete very quickly, as our world today, in 2018, is quickly moving towards the world of continuous learning, accessibility everywhere, collaborations across the world and also building creativity through automation.

REFERENCES

- Ahmed, A., & Sutton, M. J. D. (2017). Gamification, serious games, simulations, and immersive learning environments in knowledge management initiatives. *World Journal of Science, Technology and Sustainable Development, 14*(2/3), 78–83.
- Al-Bataineh, A., Anderson, S., Toledo, C., & Wellinski, S. (2008). A Study of Technology Integration in the Classroom. *International Journal of Instructional Media, 35*(4), 381–387. Retrieved from <http://proxy1.ncu.edu/login?url=http://search.ebscohost.com/login.aspx?direct=true&db=ofs&AN=508037766&site=ehost-live%5Cnhttp://content.ebscohost.com.proxy1.ncu.edu/ContentServer.asp?T=P&P=AN&K=508037766&S=R&D=ofs&EbscoContent=dGJyMNHX8kSeprE4y9f3OLCmr0y>
- Algarawi, F. K., Alslamah, W. A., Alhabib, A. A., Alfahaid, A. S., & Ibrahim, D. M. (2018). Applying Augmented Reality Technology for E-Learning System. *World Academy of Science, Engineering and Technology International Journal of Computer and Information Engineering International Science Index, Computer and Information Engineering International Scholarly and Scientific Research & Innovation, 1212*(123). Retrieved from <https://waset.org/pdf/books/?id=81543&pageNumber=1>
- Almekhlafi, A. G., & Almeqdadi, F. A. (2010). Teachers' perceptions of technology integration in the United Arab Emirates school classrooms. *Journal of Educational Technology & Society, 13*(1), 165.
- Amsel, A. (1962). FRUSTRATIVE NONREWARD IN PARTIAL REINFORCEMENT

AND DISCRIMINATION LEARNING: SOME RECENT HISTORY AND A THEORETICAL EXTENSION. *Psychological Review*, 69(4), 306–328. Retrieved from <http://0-psycnet.apa.org.mercury.concordia.ca/fulltext/1964-02017-001.pdf?sr=1>

Andena, S., Norton, B., & Kendrick, M. (2010). ICT, cultural knowledge, and teacher education in Africa.

Anderson, R. C., Spiro, R. J., & Montague, W. E. (2017). *SCHOOLING AND THE ACQUISITION OF KNOWLEDGE*. (Routledge, Ed.). ROUTLEDGE. Retrieved from [https://books.google.ca/books?id=fmE1DwAAQBAJ&dq=Anderson,+R.+C.,+Spiro,+R.+J.,+%26+Montague,+W.+E.+\(Eds.\).+2017&lr=&source=gbs_navlinks_s](https://books.google.ca/books?id=fmE1DwAAQBAJ&dq=Anderson,+R.+C.,+Spiro,+R.+J.,+%26+Montague,+W.+E.+(Eds.).+2017&lr=&source=gbs_navlinks_s)

Anderson, J. C., & Gerbing, D. W. (1988). Structural equation modeling in practice: A review and recommended two-step approach. *Psychological bulletin*, 103(3), 411.

Anggie, C., & Haryanto, J. O. (2011). Analysis of the effect of olfactory, approach behavior, and experiential marketing toward purchase intention. *Gadjah Mada International Journal of Business*, 13, 85–101.

Angus*, L., Snyder, I., & Sutherland-Smith, W. (2004). ICT and educational (dis) advantage: families, computers and contemporary social and educational inequalities. *British Journal of Sociology of Education*, 25(1), 3–18.

Angus, L., Snyder, I., & Sutherland-Smith, W. (2004). ICT and educational (dis) advantage : families , computers and contemporary social and educational inequalities. *British Journal of Sociology of Education*, 25(1), 3–18.
<http://doi.org/10.2307/4128656>

- Arbabi, A. O., Davidekova, M., Hvorecký, J., Henderson, M., Selwyn, N., Aston, R., ...
- Xiang, J. (2017). The Role of Social Media in Knowledge Management: How SECI-SM Model Can Help. *International Journal of Innovative Research and Development* | ISSN 2278-0211, 42(1), 480-485. Retrieved from http://centaur.reading.ac.uk/70274/1/PDF_Proof.PDF
- Arling, P. A., & Chun, M. W. S. (2011). Facilitating new knowledge creation and obtaining KM maturity. *Journal of Knowledge Management*, 15(2), 231-250.
- Auster, E. R., & Wylie, K. K. (2006). Creating active learning in the classroom: A systematic approach. *Journal of Management Education*, 30(2), 333-353.
- Bagozzi, R. P., Davis, F. D., & Warshaw, P. R. (1992). Development and test of a theory of technological learning and usage. *Human Relations*, 45(7), 659-686.
- Bagozzi, R. P., & Yi, Y. (1988). On the evaluation of structural equation models. *Journal of the academy of marketing science*, 16(1), 74-94.
- Barto, A. G. (2013). Intrinsic motivation and reinforcement learning. In *Intrinsically motivated learning in natural and artificial systems* (pp. 17-47). Springer.
- Bernier, R., & Bowen, J. P. (2004). Web-based discussion groups at stake: The profile of museum professionals online. *Program*, 38(2), 120-137.
- Biocca, F., & Delaney, B. (1995). Immersive virtual reality technology. *Communication in the Age of Virtual Reality*, 57-124.
- Bloom, B. (1956). *Taxonomy of learning objectives: The classification of educational goals*. New York: D. McKay Publishing.
- Bobbitt, L. M., Inks, S. A., Kemp, K. J., & Mayo, D. T. (2000). Integrating Marketing Courses to Enhance Team-Based Experiential Learning. *Journal of Marketing*

Education. <http://doi.org/10.1177/0273475300221003>

Bolisani, E., & Bratianu, C. (2018). Strategic Performance and Knowledge Measurement (pp. 175–198). Springer, Cham. http://doi.org/10.1007/978-3-319-60657-6_8

Burbules, N., & Callister, T. (2000). Universities in transition: The promise and the challenge of new technologies. *The Teachers College Record*, 102(2), 271–293. <http://doi.org/10.1111/0161-4681.00056>

Carmean, C., & Haefner, J. (2003). Next-generation course management systems. *Educause Quarterly*, 26(1), 10–13.

Chai, C. S., Hong, H.-Y., & Teo, T. (2009). Singaporean and Taiwanese Pre-service Teachers' Beliefs and their Attitude Towards ICT Use: A Comparative Study. *The Asia-Pacific Education Researcher*, 18(1), 865–869.

<http://doi.org/10.3860/taper.v18i1.1040>

Chang, H. H., & Wang, I. C. (2008). An investigation of user communication behavior in computer mediated environments. *Computers in Human Behavior*, 24(5), 2336–2356.

Chaves, M. S., Scornavacca, E., & Fowler, D. (2018). Affordances of Social Media in Knowledge Sharing in Intra-Organizational Information Technology Projects. *In Digital Technology and Organizational Change*, 35–47.

Choy, D., Wong, A. F. L., & Gao, P. (2009). Student teachers' intentions and actions on integrating technology into their classrooms during student teaching: A singapore study. *Journal of Research on Technology in Education*, 42(2), 175–195.

<http://doi.org/10.1080/15391523.2009.10782546>

Christopoulos, A., Conrad, M., & Shukla, M. (2018). Increasing student engagement

through virtual interactions: How? *Virtual Reality*, 1–17.

<http://doi.org/10.1007/s10055-017-0330-3>

Chung, J., & Tan, F. B. (2003). Antecedents of Perceived Playfulness: An Exploratory Study on User Acceptance of General Information-searching Websites. Retrieved from http://aut.researchgateway.ac.nz/bitstream/handle/10292/1068/Antecedents_playfulness.pdf?sequence=1&isAllowed=y

Churchill Jr, G. A. (1979). A paradigm for developing better measures of marketing constructs. *Journal of marketing research*, 64-73.

Comber, B., & Green, B. (1999). Information Technology, Literacy and Educational Disadvantage Research and Development: Project Report to DETE SA, Vol. 1. *More than Just Literacy? A Situated Research Study of Information Technology, Literacy Pedagogy and Educational Disadvantage, with Specific Reference to Six South Australian Public Schools.*

Cook, S. D. N., & Brown, J. S. (1999). Bridging epistemologies: The generative dance between organizational knowledge and organizational knowing. *Organization Science*, 10(4), 381–400.

Cross, K. P. (1976). Accent on Learning. Improving Instruction and Reshaping the Curriculum.

Csikszentmihalyi, M. (1975). Play and intrinsic rewards. *Journal of Humanistic Psychology*.

Csikszentmihalyi, M. (1990). Flow: The psychology of optimal performance. NY: Cambridge University Press, 40.

- Csikszentmihalyi, M., & Csikszentmihalyi, I. S. (1992). *Optimal experience: Psychological studies of flow in consciousness*. Cambridge university press.
- Davis, F. D. (1989). Perceived usefulness, perceived ease of use, and user acceptance of information technology. *MIS Quarterly*, 319–340.
- Davis, F. D., Bagozzi, R. P., & Warshaw, P. R. (1992). Extrinsic and intrinsic motivation to use computers in the workplace. *Journal of Applied Social Psychology*, 22(14), 1111–1132.
- Davis, S., & Wiedenbeck, S. (2001). The mediating effects of intrinsic motivation, ease of use and usefulness perceptions on performance in first-time and subsequent computer users. *Interacting with Computers*, 13(5), 549–580.
- Dearman, J. K. (2015). Increasing college students' experience of flow while completing academic writing tasks.
- Doering, A., Hughes, J., & Huffman, D. (2003). Preservice teachers: Are we thinking with technology? *Journal of Research on Technology in Education*, 35(3), 342–361. <http://doi.org/10.1080/15391523.2003.10782390>
- Doménech-Betoret, F., Abellán-Roselló, L., & Gómez-Artiga, A. (2017). Self-Efficacy, Satisfaction, and Academic Achievement: The Mediator Role of Students' Expectancy-Value Beliefs. *Frontiers in Psychology*, 8, 1193. <http://doi.org/10.3389/fpsyg.2017.01193>
- Economist. (2008). The Future of Higher Education: How Technology Will Shape Learning. *Economist Intelligence Unit*, 1–31. <http://doi.org/10.1111/bjet.12049>
- Ertmer, P. A., & Ottenbreit-Leftwich, A. T. (2010). Teacher technology change: How knowledge, confidence, beliefs, and culture intersect. *Journal of Research on*

Technology in Education, 42(3), 255–284.

<http://doi.org/10.1080/15391523.2010.10782551>

- Esteban-Millat, I., Martínez-López, F. J., Huertas-García, R., Meseguer, A., & Rodríguez-Ardura, I. (2014). Modelling students' flow experiences in an online learning environment. *Computers & Education*, 71, 111–123.
- Facer, K., Furlong, J., & Furlong, R. (2010). Constructing the child computer user: From public policy to private practices. *British Journal of Sociology of Education*, 22(1), 91–108. <http://doi.org/10.1080/0142569002003080>
- Fagerholm, H., & Helelä, M. (2003). *Handbook for Transforming a BBA Program in International Business Into a Problem-based Learning Curriculum: Case: Liibba Program at Helia*. Helsinki Business Polytechnic.
- Fernandes, K. J., Raja, V. H., & Eyre, J. (2003). Immersive learning system for manufacturing industries. *Computers in Industry*, 51(1), 31–40.
- Finneran, C. M., & Zhang, P. (2003). A person–artefact–task (PAT) model of flow antecedents in computer-mediated environments ARTICLE IN PRESS. *Int. J. Human-Computer Studies*, 59, 475–496. [http://doi.org/10.1016/S1071-5819\(03\)00112-5](http://doi.org/10.1016/S1071-5819(03)00112-5)
- Foote, A., & Halawi, L. A. (2018). Knowledge Management Models within Information Technology Projects. *Journal of Computer Information Systems*, 58(1), 89–97.
- Frederick, G. R., Schweizer, H., & Lowe, R. (2006). After the in-service course challenges of technology integration. *Computers in the Schools*, 23(1–2), 73–84. http://doi.org/10.1300/J025v23n01_07
- Fu, J. S. (2013). ICT in Education: A Critical Literature Review and Its Implications.

International Journal of Education and Development Using Information and Communication Technology, 9(1), 112–125.

<http://doi.org/http://ijedict.dec.uwi.edu//viewarticle.php?id=1541>

Furneaux, C. W. (2004). How does Information Technology impact the methods, potential and purpose of education? *ETL Conference, 2004, Logan Campus, Griffith University*, (2000). Retrieved from <http://eprints.qut.edu.au/794/>

Glenn, M., & D'Agostino, D. (2008). The future of higher education: How technology will shape learning. *New Media Consortium*.

Goktas, Y., Yildirim, S., & Yildirim, Z. (2009). Main barriers and possible enablers of ICTs Integration into pre-service teacher education programs. *Educational Technology and Society*, 12(1), 193–204. <http://doi.org/Article>

Gottlieb, J., Hayhoe, M., Hikosaka, O., & Rangel, A. (2014). Symposium Attention, Reward, and Information Seeking. *The Journal of Neuroscience*, 34(46), 15497–15504. <http://doi.org/10.1523/JNEUROSCI.3270-14.2014>

Gourlay, S. (2006). Conceptualizing knowledge creation: a critique of Nonaka's theory. *Journal of Management Studies*, 43(7), 1415–1436.

Grant, R. M., & Baden-Fuller, C. (2000). Knowledge and economic organization: an application to the analysis of interfirm collaboration. In *Knowledge Creation* (pp. 113–150). Springer.

Hardaker, G., & Smith, D. (2002). E-learning communities, virtual markets and knowledge creation. *European Business Review*, 14(5), 342–350.

Harsh, O. K. (2009). Three dimensional knowledge management and explicit knowledge reuse. *Journal of Knowledge Management Practice*, 10(2), 1–10.

- Hassenzahl, M., Platz, A., Burmester, M., & Lehner, K. (2000). Hedonic and ergonomic quality aspects determine a software's appeal. In *Proceedings of the SIGCHI conference on Human Factors in Computing Systems* (pp. 201–208). ACM.
- Heisig, P. (2009). Harmonisation of knowledge management—comparing 160 KM frameworks around the globe. *Journal of Knowledge Management*, 13(4), 4–31.
- Henderson, M., Selwyn, N., & Aston, R. (2017). What works and why? Student perceptions of “useful” digital technology in university teaching and learning. *Studies in Higher Education*, 42(8), 1567–1579.
- Her, P. (2017). *Students' Perceptions on Adoption of Desktop Virtualization in Higher Education Environment: A Multiple Case Study*. Retrieved from <https://search.proquest.com/openview/8a0410c763dd2cbd90d3ce74a1e46094/1?pq-origsite=gscholar&cbl=18750&diss=y>
- Herrera, F., Guerrero, M., & Urbano, D. (2018). Entrepreneurship and Innovation Ecosystem's Drivers: The Role of Higher Education Organizations (pp. 109–128). Springer, Cham. http://doi.org/10.1007/978-3-319-71014-3_6
- Higgins, S., Xiao, Z., & Katsipataki, M. (2012). The impact of digital technology on learning: A summary for the education endowment foundation. *Durham, UK: Education Endowment Foundation and Durham University*.
- Hjørland, B. (2008). Information literacy and digital literacy. *Prisma. Com*, (7), 4–15.
- Ho, A. G. (2017). Enriching the User Experience in Social Messaging: Emotion in Communication Design. *Online Journal of Art and Design*, 5(1). Retrieved from <http://www.adjournal.net/articles/51/515.pdf>
- Honan, E. (2008). Barriers to teachers using digital texts in literacy classrooms. *Literacy*,

42(1), 36–43. <http://doi.org/10.1111/j.1467-9345.2008.00480.x>

Hu, L. T., & Bentler, P. M. (1999). Cutoff criteria for fit indexes in covariance structure analysis: Conventional criteria versus new alternatives. *Structural equation modeling: a multidisciplinary journal*, 6(1), 1-55.

Huang, M. H. (2003). Designing website attributes to induce experiential encounters. *Computers in Human Behavior*, 19(4), 425–442. [http://doi.org/10.1016/S0747-5632\(02\)00080-8](http://doi.org/10.1016/S0747-5632(02)00080-8)

Hultén, B. (2011). Sensory marketing: the multi-sensory brand-experience concept. *European Business Review*, 23(3), 256–273.
<http://doi.org/10.1108/09555341111130245>

Hutchison, A., & Reinking, D. (2011). Teachers' perceptions of integrating information and communication technologies into literacy instruction: A national survey in the United States. *Reading Research Quarterly*. <http://doi.org/10.1002/RRQ.002>

Inal, Y., & Cagiltay, K. (2007). Flow experiences of children in an interactive social game environment. *British Journal of Educational Technology*, 38(3), 455–464.

Inks, S. A., & Avila, R. A. (2008). Preparing the next generation of sales professionals through social, experiential, and immersive learning experiences. *Journal for Advancement of Marketing Education*, 13(4), 47–55.

Jackson, S. A., & Marsh, H. W. (1996). Development and Validation of a Scale to Measure Optimal Experience: The Flow State Scale. *JOURNAL OF SPORT & EXERCISE PSYCHOLOGY*, 18, 17–35. Retrieved from <http://fitnessforlife.org/AcuCustom/Sitename/Documents/DocumentItem/8983.pdf>

Jakubik, M. (2008). Experiencing collaborative knowledge creation processes. *The*

Learning Organization, 15(1), 5–25.

Jakubik, M. (2011). Becoming to know. Shifting the knowledge creation paradigm.

Journal of Knowledge Management, 15(3), 374–402.

Johnson, L. F., & Levine, A. H. (2008). Virtual worlds: Inherently immersive, highly social learning spaces. *Theory Into Practice*, 47(2), 161–170.

Jonassen, D. (1999). Designing constructivist learning environments. In *Instructional-Design Theories and Models* (Vol. 2, pp. 215–239).

Kalay, Y. E. (2004). Virtual learning environments. *Journal of Information Technology in Construction (ITcon)*, 9, 195–207.

Kassim, M. H., Abdullah, F., Denan, Z., & Arafat, K. A. (2017). Physical versus Augmented Reality Model: Comparative Study Toward Learning Experiences at Heritage Studies Gallery. *Advanced Science Letters*, 23(2), 890–893.

Kefor, T. (2015). *Arts students in flow: An interpretative phenomenological analysis*. Northeastern University.

Kersh, B. Y. (1962). The motivating effect of learning by directed discovery. *Journal of Educational Psychology*, 53(2), 65.

Kidd, C., & Hayden, B. Y. (2015). The psychology and neuroscience of curiosity. *Neuron*, 88(3), 449–460.

Kiili, K. (2005). Content creation challenges and flow experience in educational games: The IT-Emperor case. *The Internet and Higher Education*, 8(3), 183–198.

Klebba, J. M., & Hamilton, J. G. (2007). Structured Case Analysis: Developing Critical Thinking Skills in a Marketing Case Course. *Journal of Marketing Education*.

<http://doi.org/10.1177/0273475307302015>

- Koufaris, M. (2002). Applying the technology acceptance model and flow theory to online consumer behavior. *Information Systems Research, 13*(2), 205–223.
- Krishna, A., Morrin, M., & Sayin, E. (2014). Smellizing Cookies and Salivating: A Focus on Olfactory Imagery. *Journal of Consumer Research, 41*(1), 18–34.
<http://doi.org/10.1086/674664>
- Kristensen, T. (1999). The "Reidar" Project. In *Proceedings of The Sixteenth International Conference on Technology and Education. Edinburgh, UK.*
- Lavie, T., & Tractinsky, N. (2004). Assessing dimensions of perceived visual aesthetics of web sites. *International Journal of Human-Computer Studies, 60*(3), 269–298.
- Leong, P. (2011). Role of social presence and cognitive absorption in online learning environments. *Distance Education, 32*(1), 5–28.
- Li, H., Lai, V., & Luo, X. (2016). Understanding the role of social situations on continuance participation intention in online communities: An empirical perspective. *Journal of Electronic Commerce Research, 17*(4), 358–380.
- Lim, C. P. (2007). Effective integration of ICT in Singapore schools: Pedagogical and policy implications. *Educational Technology Research and Development, 55*(1), 83–116. <http://doi.org/10.1007/s11423-006-9025-2>
- Lin, C. S., Wu, S., & Tsai, R. J. (2005). Integrating perceived playfulness into expectation-confirmation model for web portal context. *Information & Management, 42*(5), 683–693.
- Liu, Y., & Szabo, Z. (2009). Teachers' attitudes toward technology integration in schools: A four-year study. *Teachers and Teaching: Theory and Practice, 15*(1), 5–23. <http://doi.org/10.1080/13540600802661295>

- Ludvigsen, S., & Arnseth, H. C. (2017). Computer-supported collaborative learning. In *Technology enhanced learning* (pp. 47–58). Springer.
- Macfarlane, A., & Robson, M. (2017). An interactive model for delivery of a distance learning LLM programme using the eXe learning tool-our journey.
- Martocchio, J. J. (1994). Effects of conceptions of ability on anxiety, self-efficacy, and learning in training. *Journal of Applied Psychology, 79*(6), 819.
- Maslowski, R. (2001). *School Culture and School Performance. Culture*. Retrieved from <https://research.utwente.nl/en/publications/school-culture-and-school-performance-an-explorative-study-into-t>
- Meyer, K. A., & Jones, S. J. (2013). Do Students Experience Flow Conditions Online?. *Journal of Asynchronous Learning Networks, 17*(3), 137–148.
- Meyers, E. M., Erickson, I., & Small, R. V. (2013). Digital literacy and informal learning environments: an introduction. *Learning, Media and Technology, 38*(4), 355–367.
- Milgram, P., Takemura, H., Ustimi, A., & Kishino, F. (1994). Augmented Reality: A class of display on the reality-virtuality continuum. *Telem manipulator and Telepresence Technologies, 2351*, 282–292.
- Moen, Ø., Benum, J. D., & Gjørum, I. (2018). Exploring Informal and Formal Learning Activities as Enablers of Learning-by-Exporting in Small and Medium Sized Firms. *Advances in Global Marketing, 127–146*.
- Moon, J.-W., & Kim, Y.-G. (2001). Extending the TAM for a World-Wide-Web context. *Information & Management, 38*(4), 217–230.
- Mostafa, A. (2018). Mediating Experiential Learning in Interactive Immersive Environments.

- Mukherjee, A., & Bleakney, S. (2017). Redesigning an Introduction to Information Systems Course for Scalable Active Learning in Online and Blended Environments.
- Newman, F., & Scurry, J. E. (2015). Higher education and the digital Rapids. *International Higher Education*, (26).
- Nguyen, L., Barton, S. M., & Nguyen, L. T. (2015). iPads in higher education—Hype and hope. *British Journal of Educational Technology*, 46(1), 190–203.
- Niederman, F., & Rollier, B. (2001). How are you going to keep them in the classroom after they've seen MTV? Online education in a virtual world. In *Our Virtual World: The Transformation of Work, Play and Life via Technology* (pp. 56–73). IGI Global.
- Nonaka, Ikujiro, Takeuchi, H., & Umemoto, K. (1996). A theory of organizational knowledge creation. *International Journal of Technology Management*, 11(7–8), 833–845.
- Nonaka, I., Toyama, R., & Hirata, T. (2008). *Managing flow: A process theory of the knowledge-based firm*. Springer.
- Nonaka, I., Toyama, R., & Konno, N. (2000). SECI, Ba and leadership: a unified model of dynamic knowledge creation. *Long Range Planning*, 33(1), 5–34.
- North, M. M. (2014). Distance learning immersive environments: Sense of presence exploration. *Journal of Visual Languages & Computing*.
<http://doi.org/10.1016/j.jvlc.2014.09.006>
- Oudeyer, P.-Y., Kaplan, F., & Hafner, V. V. (2007). Intrinsic motivation systems for autonomous mental development. *IEEE Transactions on Evolutionary Computation*, 11(2), 265–286.
- Pearce, J. M., Ainley, M., & Howard, S. (2005). The ebb and flow of online learning.

Computers in Human Behavior, 21(5), 745–771.

- Pena-Rios, A., Callaghan, V., & Gardner, M. (2018). Multi-User Mixed Reality Environments for Distance Learning. In *Integrating Multi-User Virtual Environments in Modern Classrooms* (pp. 208–237). UK. Retrieved from https://books.google.ca/books?hl=en&lr=&id=gpBFDwAAQBAJ&oi=fnd&pg=PA208&dq=Peña-Rios,+A.,+Callaghan,+V.,+%26+Gardner,+M.+2018&ots=q7gdJ2Gwi2&sig=Im90KnZWbrhd7Z3yUHewTqBWGGQ&redir_esc=y#v=onepage&q&f=false
- Pirker, J., Kultima, A., & Gütl, C. (2016). The value of game prototyping projects for students and industry. In *Proceedings of the International Conference on Game Jams, Hackathons, and Game Creation Events* (pp. 54–57). ACM.
- Quintana, M. G. B., & Aranguiz, M. S. B. (2018). Use of ICT to innovate teaching and learning processes in higher education. In *Enhancing Knowledge Discovery and Innovation in the Digital Era - Google Books* (p. 36). Chile. Retrieved from https://books.google.ca/books?hl=en&lr=&id=hpBFDwAAQBAJ&oi=fnd&pg=PA36&dq=Quintana,+M.+G.+B.,+%26+Aránguiz,+M.+S.+B.+2018&ots=5VQjaT-qO3&sig=UieRSrkiYxwcCfp4k4kDoZPMM3g&redir_esc=y#v=onepage&q&f=false
- Randall, A., & Ruddell, S. (1946). Adult Literacy. *Journal of Adolescent & Adult Literacy*.
- Reddy, R., & PS Goodman. (2002). Technology trends and implications for learning in tertiary institutions. *Books.google.com*. Retrieved from <https://books.google.ca/books?hl=en&lr=&id=DcSQAqAAQBAJ&oi=fnd&pg=PA3>

&dq=Technology+Trends+and+Implications+for+Learning+in+Tertiary+Institution
s.+In+P.S.+Goodman+(Ed.)+&ots=25oxSP7PsS&sig=nOEOPecAMg1boeUaASVd
WuHDQwM

Rodríguez-Ardura, I., & Meseguer-Artola, A. (2017). Flow in e-learning: What drives it and why it matters. *British Journal of Educational Technology*, 48(4), 899–915.
<http://doi.org/10.1111/bjet.12480>

Rossin, D., Ro, Y. K., Klein, B. D., & Guo, Y. M. (2009). The effects of flow on learning outcomes in an online information management course. *Journal of Information Systems Education*, 20(1), 87.

Roy, A. (2005). Debating the Issues: A Tool for Augmenting Critical Thinking Skills of Marketing Students. *Journal of Marketing Education*.
<http://doi.org/10.1177/0273475305280533>

Ryoo Christopher Rodrigues Sara S Baghsorkhi Sam S Stone David B Kirk, S. I., & Hwu, W. W. (n.d.). Optimization Principles and Application Performance Evaluation of a Multithreaded GPU Using CUDA. Retrieved from
<https://www.eecis.udel.edu/~cavazos/cisc879-spring2008/papers/ppopp-08-ryoo.pdf>

Saadé, R., & Bahli, B. (2004). The impact of cognitive absorption on perceived usefulness and perceived ease of use in on-line learning: an extension of the technology acceptance model. <http://doi.org/10.1016/j.im.2003.12.013>

Saadé, R. G., Tan, W., & Kira, D. (2008). Is usage predictable using belief-attitude-intention paradigm? *Issues in Informing Science & Information Technology*, 5.

Saade, R., Nebebe, F., & Mak, T. (2011). Interdisciplinary Journal of Information, Knowledge, and Management Knowledge Management Systems Development:

Theory and Practice. Retrieved from <http://www.ijikm.org/Volume6/IJIKMv6p035-072Saade472.pdf>

Sánchez-Franco, M. J., & Roldán, J. L. (2005). Web acceptance and usage model: A comparison between goal-directed and experiential web users. *Internet Research*, 15(1), 21–48.

Sautter, P. (2007). Designing Discussion Activities to Achieve Desired Learning Outcomes: Choices Using Mode of Delivery and Structure. *Journal of Marketing Education*. <http://doi.org/10.1177/0273475307302014>

Schmitt, U., & Saadé, R. G. (2017). Taking on Opportunity Divides via Smart Educational and Personal Knowledge Management Technologies. In R. H. Laurie O. Campbell (Ed.), *ICEL 2017 - Proceedings of the 12th International Conference on e-Learning - Google Books* (p. 188). Retrieved from <https://books.google.ca/books?hl=en&lr=&id=2R8zDwAAQBAJ&oi=fnd&pg=PA188&dq=related:8rJhHka2lTMJ:scholar.google.com/&ots=2GJ4geSts0&sig=VO3AK0bNizDFydaA1QR2Rmz9dXY#v=onepage&q&f=false>

Scoppio, G., & Luyt, I. (2017). Mind the gap: Enabling online faculty and instructional designers in mapping new models for quality online courses. *Education and Information Technologies*, 22(3), 725–746.

Sein-Echaluze, M. L., Fidalgo-Blanco, Á., & García-Peñalvo, F. J. (2017). Adaptive and cooperative model of knowledge management in MOOCs, 273–284. http://doi.org/10.1007/978-3-319-58509-3_22

Senge, P., & Scharmer, O. (2001). Community Action Research 1. *Handbook of Action Research*, 1–32. Retrieved from

http://www.ottoscharmer.com/sites/default/files/2001_CAR.pdf

Serenko, A., Bontis, N., Booker, L., Sadeddin, K., & Hardie, T. (2010). A scientometric analysis of knowledge management and intellectual capital academic literature (1994-2008). *Journal of Knowledge Management*, *14*(1), 3–23.

<http://doi.org/10.1108/13673271011015534>

Sincak, C., Gunn, J., Conroy, C., Komperda, K., Van Kanegan, K., Krumdick, N., ... Heinking, K. (2017). Transformation of an online multidisciplinary course into a live interprofessional experience. *American Journal of Pharmaceutical Education*, *81*(5), 94.

Soden, B. (2017). The Case of Screencast Feedback: Barriers to the Use of Learning Technology. *Innovative Practice in Higher Education*, *3*(1).

Stacey, R. D. (2001). *Complex responsive processes in organizations: Learning and knowledge creation*. Psychology Press.

Ştefan, L. (2012a). Immersive collaborative environments for teaching and learning traditional design. *Procedia-Social and Behavioral Sciences*, *51*, 1056–1060.

Ştefan, L. (2012b). Immersive Collaborative Environments for Teaching and Learning Traditional Design. *Procedia - Social and Behavioral Sciences*, *51*, 1056–1060.

<http://doi.org/10.1016/j.sbspro.2012.08.287>

Summers, C., Reiff, P., & Weber, W. (2008). Learning in an immersive digital theater. *Advances in Space Research*, *42*(11), 1848–1854.

<http://doi.org/10.1016/j.asr.2008.06.018>

Sun, J., Huynh, V.-N., Nakamori, Y., Wu, J., Tian, J., & Xiang, J. (2017). Knowledge Management in Graduate Research. In *Software Quality, Reliability and Security*

- Companion (QRS-C), 2017 IEEE International Conference on* (pp. 480–485). IEEE.
- Sun, P. (2010). Five critical knowledge management organizational themes. *Journal of Knowledge Management, 14*(4), 507–523.
- Teo, T., & Zhou, M. (2017). The influence of teachers' conceptions of teaching and learning on their technology acceptance. *Interactive Learning Environments, 25*(4), 513–527. <http://doi.org/10.1080/10494820.2016.1143844>
- Tezci, E. (2011). Factors that influence pre-service teachers' ICT usage in education. *European Journal of Teacher Education, 34*(4), 483–499. <http://doi.org/10.1080/02619768.2011.587116>
- Thomas, T. D., Singh, L., & Gaffar, K. (2013). The utility of the UTAUT model in explaining mobile learning adoption in higher education in Guyana. *International Journal of Education and Development Using Information and Communication Technology, 9*(3), 71–85. Retrieved from <https://files.eric.ed.gov/fulltext/EJ1071379.pdf>
- Tsoukas, H. (2000). Knowledge as action, organization as theory: reflections on organizational knowledge. *Emergence, A Journal of Complexity Issues in Organizations and Management, 2*(4), 104–112.
- Vallerand, R. J. (1997). Toward a hierarchical model of intrinsic and extrinsic motivation. In *Advances in experimental social psychology* (Vol. 29, pp. 271–360). Elsevier.
- Van Schaik, P., Martin, S., & Vallance, M. (2012). Measuring flow experience in an immersive virtual environment for collaborative learning. *Journal of Computer Assisted Learning, 28*, 350–365. <http://doi.org/10.1111/j.1365->

2729.2011.00455.x

- Venkatesh, V. (1999). Creation of favorable user perceptions: exploring the role of intrinsic motivation. *MIS Quarterly*, 239–260.
- Venkatesh, V., Morris, M. G., Davis, G. B., & Davis, F. D. (2003). User acceptance of information technology: Toward a unified view. *MIS Quarterly*, 425–478.
- Venkatesh, V., Speier, C., & Morris, M. G. (2002). User acceptance enablers in individual decision making about technology: Toward an integrated model. *Decision Sciences*, 33(2), 297–316.
- Villagrasa, S., Fonseca, D., Redondo, E., & Duran, J. (2014). Teaching Case of Gamification and Visual Technologies for Education. *Journal of Cases on Information Technology*, 16(4), 38–57. <http://doi.org/10.4018/jcit.2014100104>
- Von Krogh, G., Ichijo, K., & Nonaka, I. (2000). *Enabling knowledge creation: How to unlock the mystery of tacit knowledge and release the power of innovation*. Oxford University Press on Demand.
- Wandersee, J. H., Mintzes, J. J., & Novak, J. D. (1994). Research on Alternative Conceptions in Science. In *Handbook of Research of Science Teaching and Learning* (pp. 177–210).
- Wenger, E. C., & Snyder, W. M. (2000). Communities of practice: The organizational frontier. *Harvard Business Review*, 78(1), 139–146.
- Whelan, R. (2008). Use of ICT in education in the South Pacific: Findings of the Pacific eLearning Observatory. *Distance Education*, 29(1), 53–70.
<http://doi.org/10.1080/01587910802004845>
- Winkler, K., & Wagner, B. (2018). The relevance of knowledge management in the

context of leadership. *Journal of Applied Leadership and Management*, 5(1).

Wlodkowski, R. J., & Westover, T. N. (1999). Accelerated courses as a learning format for adults. *The Canadian Journal for the Study of Adult Education*, 13(1), 1.

Woolfolk Hoy, A., Davis, H. A., & Anderman, E. M. (2013). Theories of Learning and Teaching in TIP. *Theory Into Practice*, 52(sup1), 9–21.

<http://doi.org/10.1080/00405841.2013.795437>

Yildirim, S. (2007). Current utilization of ICT in Turkish basic education schools: A review of teacher's ICT use and barriers to integration. *International Journal of Instructional Media*, 34(2), 171.

Young, M. R. (2005). The Motivational Effects of the Classroom Environment in Facilitating Self-Regulated Learning. *Journal of Marketing Education*.

<http://doi.org/10.1177/0273475304273346>

Zboralski, K. (2009). Antecedents of knowledge sharing in communities of practice. *Journal of Knowledge Management*, 13(3), 90–101.

APPENDIX A CONSENT Form

Survey Preview

CONSENT TO PARTICIPATE IMMERSIVE LEARNING PROJECT

This is to state that I agree to participate in a program of research being conducted by Samie Li Shang Ly (Ph.D student in Administration) under the supervision of Raafat Saade, Department of SC&BTM, of Concordia University, phone 514.848.2424 extension 2988.

A. PURPOSE

I have been informed that the purpose of the research is to better understand how people learn and assess course material in business programs at the university level.

B. PROCEDURES

In this research, I will be invited to evaluate the Peer to Peer Interactive Learning System and to go through an examination process by answering course material and demographic questions.
The experiment will last from 1.5 hours to 3 hours depending on the group and day assigned for the experiment. Information will be taken, however will be kept confidential to the public. Only the researchers will keep the information for research purposes.

C. RISKS AND BENEFITS

This study helps researchers better understand the effectiveness of learning in different environments. There are no risks associated with participation in this research. All questions and process are of general nature. If I don't feel comfortable with any of the questions/process, I can leave and stop participation at any time.

D. CONDITIONS OF PARTICIPATION

- I understand that I am free to withdraw my consent and discontinue my participation at anytime without negative consequences.
- I understand that my participation in this study is noted, however only accessible to the researchers
- I understand that the data from this study may be published. I can contact the researchers for any questions.

If at any time you have questions about the proposed research, please contact R. Saade, Department of Supply Chain and Business Technology Management, at 514.848.2424 x. 2988 or Samie Li Shang Ly, Department of Supply Chain and Business Technology Management lly@jmsb.concordia.ca. If at any time you have questions about your rights as a research participant, please contact the Research Ethics and Compliance Advisor, Concordia University at (514) 848-2424 x 7481 or by email at ethics@alcor.concordia.ca.

I HAVE CAREFULLY STUDIED THE ABOVE AND UNDERSTAND THIS AGREEMENT. I FREELY CONSENT AND VOLUNTARILY AGREE TO PARTICIPATE IN THIS STUDY.

Yes, I Agree No, I do not agree

APPENDIX B QUESTIONNAIRE

P2P Section 1

	1- Strongly disagree	2.	3.	4. Neutral	5.	6.	7. Strongly agree
Sometimes I lost track of time when I was using the P2P SYSTEM	<input type="radio"/>	<input type="radio"/>	<input type="radio"/>	<input type="radio"/>	<input type="radio"/>	<input type="radio"/>	<input type="radio"/>
Time flew when I was using the P2P SYSTEM	<input type="radio"/>	<input type="radio"/>	<input type="radio"/>	<input type="radio"/>	<input type="radio"/>	<input type="radio"/>	<input type="radio"/>
Most times when I got on to the P2P SYSTEM, I ended up spending more time than I had planned	<input type="radio"/>	<input type="radio"/>	<input type="radio"/>	<input type="radio"/>	<input type="radio"/>	<input type="radio"/>	<input type="radio"/>
When I was using the P2P SYSTEM I was able to block out most other distractions	<input type="radio"/>	<input type="radio"/>	<input type="radio"/>	<input type="radio"/>	<input type="radio"/>	<input type="radio"/>	<input type="radio"/>
While using the P2P SYSTEM, I was absorbed in what I was doing	<input type="radio"/>	<input type="radio"/>	<input type="radio"/>	<input type="radio"/>	<input type="radio"/>	<input type="radio"/>	<input type="radio"/>
While using the P2P SYSTEM, I was immersed in the task I was performing	<input type="radio"/>	<input type="radio"/>	<input type="radio"/>	<input type="radio"/>	<input type="radio"/>	<input type="radio"/>	<input type="radio"/>
I had fun interacting with the P2P SYSTEM	<input type="radio"/>	<input type="radio"/>	<input type="radio"/>	<input type="radio"/>	<input type="radio"/>	<input type="radio"/>	<input type="radio"/>
Using the P2P SYSTEM Bored me	<input type="radio"/>	<input type="radio"/>	<input type="radio"/>	<input type="radio"/>	<input type="radio"/>	<input type="radio"/>	<input type="radio"/>
I enjoyed using the P2P SYSTEM	<input type="radio"/>	<input type="radio"/>	<input type="radio"/>	<input type="radio"/>	<input type="radio"/>	<input type="radio"/>	<input type="radio"/>

P2P Section 2

	1. Very Dissatisfied	2.	3.	4. Neutral	5.	6.	7. Very Satisfied
Tell us about your experience with the P2P System.							
How satisfied are you with the quality of the outcome which you and the other party reached?	<input type="radio"/>	<input type="radio"/>	<input type="radio"/>	<input type="radio"/>	<input type="radio"/>	<input type="radio"/>	<input type="radio"/>
To what extent does the final outcome realistically reflect your objectives?	<input type="radio"/>	<input type="radio"/>	<input type="radio"/>	<input type="radio"/>	<input type="radio"/>	<input type="radio"/>	<input type="radio"/>
To what extent are you confident that the outcome is acceptable?	<input type="radio"/>	<input type="radio"/>	<input type="radio"/>	<input type="radio"/>	<input type="radio"/>	<input type="radio"/>	<input type="radio"/>
How would you describe the P2P System process you and the other party used?							
<input type="radio"/> 1. Efficient <input type="radio"/> 2. <input type="radio"/> 3. <input type="radio"/> 4. <input type="radio"/> 5. <input type="radio"/> 6. <input type="radio"/> 7. Inefficient							
How would you describe the P2P System process you and the other party used?							
<input type="radio"/> 1. Uncoordinated <input type="radio"/> 2. <input type="radio"/> 3. <input type="radio"/> 4. <input type="radio"/> 5. <input type="radio"/> 6. <input type="radio"/> 7. Coordinated							
How would you describe the P2P System process you and the other party used?							
<input type="radio"/> 1. Fair <input type="radio"/> 2. <input type="radio"/> 3. <input type="radio"/> 4. <input type="radio"/> 5. <input type="radio"/> 6. <input type="radio"/> 7. Unfair							
How would you describe the P2P System process you and the other party used?							
<input type="radio"/> 1. Dissatisfying <input type="radio"/> 2. <input type="radio"/> 3. <input type="radio"/> 4. <input type="radio"/> 5. <input type="radio"/> 6. <input type="radio"/> 7. Satisfying							

P2P Section 3

Would you use P2P SYSTEM to actually use in your studies during:

- Tutorial Study for an exam Learning in regular classes Study in Group

P2P Section 4

	1- Strongly disagree	2.	3.	4. Neutral	5.	6.	7. Strongly agree
I find the P2P Program useful.	<input type="radio"/>	<input type="radio"/>	<input type="radio"/>	<input type="radio"/>	<input type="radio"/>	<input type="radio"/>	<input type="radio"/>
Using P2P Program enables me to accomplish learning tasks more quickly.	<input type="radio"/>	<input type="radio"/>	<input type="radio"/>	<input type="radio"/>	<input type="radio"/>	<input type="radio"/>	<input type="radio"/>
Using P2P Program increases the effective use of my time in handling learning tasks/assignments.	<input type="radio"/>	<input type="radio"/>	<input type="radio"/>	<input type="radio"/>	<input type="radio"/>	<input type="radio"/>	<input type="radio"/>
Using P2P Program increases the quality of my learning tasks at minimal efforts.	<input type="radio"/>	<input type="radio"/>	<input type="radio"/>	<input type="radio"/>	<input type="radio"/>	<input type="radio"/>	<input type="radio"/>
My interactions in P2P Program is clear and understandable.	<input type="radio"/>	<input type="radio"/>	<input type="radio"/>	<input type="radio"/>	<input type="radio"/>	<input type="radio"/>	<input type="radio"/>
I am skillful at using P2P Program.	<input type="radio"/>	<input type="radio"/>	<input type="radio"/>	<input type="radio"/>	<input type="radio"/>	<input type="radio"/>	<input type="radio"/>
Learning to use the P2P Program is easy for me.	<input type="radio"/>	<input type="radio"/>	<input type="radio"/>	<input type="radio"/>	<input type="radio"/>	<input type="radio"/>	<input type="radio"/>
I find it easy to get the P2P Program to do what I want it to do.	<input type="radio"/>	<input type="radio"/>	<input type="radio"/>	<input type="radio"/>	<input type="radio"/>	<input type="radio"/>	<input type="radio"/>
I have the resources necessary to use the learning systems (websites) at the university.	<input type="radio"/>	<input type="radio"/>	<input type="radio"/>	<input type="radio"/>	<input type="radio"/>	<input type="radio"/>	<input type="radio"/>
I have the knowledge necessary to use the learning systems (websites) at the university.	<input type="radio"/>	<input type="radio"/>	<input type="radio"/>	<input type="radio"/>	<input type="radio"/>	<input type="radio"/>	<input type="radio"/>
A specific person (or group) is available for assistance with learning systems (websites) difficulties.	<input type="radio"/>	<input type="radio"/>	<input type="radio"/>	<input type="radio"/>	<input type="radio"/>	<input type="radio"/>	<input type="radio"/>
I intend to continue using the P2P system.	<input type="radio"/>	<input type="radio"/>	<input type="radio"/>	<input type="radio"/>	<input type="radio"/>	<input type="radio"/>	<input type="radio"/>
I predict that I would use the P2P system in the future.	<input type="radio"/>	<input type="radio"/>	<input type="radio"/>	<input type="radio"/>	<input type="radio"/>	<input type="radio"/>	<input type="radio"/>

Improvements

Do you recommend any improvement of this system?

Do you recommend any improvements to this system?

Favorites

What were your favorite parts of the P2P system?

What were your favorite parts of the system?

APPENDIX C ETHICS CERTIFICATE



CERTIFICATION OF ETHICAL ACCEPTABILITY FOR RESEARCH INVOLVING HUMAN SUBJECTS

Name of Applicant: Samie Li Shang Ly
Department: John Molson School of Business\Marketing
Agency: N/A
Title of Project: Peer to Peer Learning Project
Certification Number: 30005052

Valid From: February 12, 2018 To: February 11, 2019

The members of the University Human Research Ethics Committee have examined the application for a grant to support the above-named project, and consider the experimental procedures, as outlined by the applicant, to be acceptable on ethical grounds for research involving human subjects.

A handwritten signature in black ink, appearing to read "J. Pfaus".

Dr. James Pfaus, Chair, University Human Research Ethics Committee

APPENDIX D PAPER 1

This paper was first presented in Florida, Informing Science Institute 2015, and published in the Journal of Information Technology in Education, 2017.

Title: Immersion Learning: Using a web-based learning tool in a phd course to enhance the learning experience.

Authors:

Samie Li Shang Ly, Concordia University

Raafat Saade, Concordia University

Danielle Morin, Concordia University

Abstract:

Aim/Purpose: Teaching and learning is no longer the same and the paradigm shift has not settled yet. Information technology (IT) and its worldwide use impacted student-learning methods and associated pedagogical models.

Background In this study we frame immersive learning as a method, which we believe, can be designed by pedagogical models such as experiential, constructivist and collaborative elements. We also present a peer-to-peer interactive web based learning tool, designed and implemented in-house with immersive learning features.

Methodology: We conducted an exploratory research with a Ph.D course on “pedagogical methods” where 9 doctoral students were tasked to follow the peer-to-peer 3 phase process in their learning.

Contribution: We found the peer-to-peer does favor experiential, constructivist, collaborative learning which contributes into the use of immersive learning as an important learning style for the future.

Findings: This study investigated on different ways to measure students' collaboration, constructivism with one another in an immersive learning environment by taking the roles of teacher, evaluator and learner.

Keywords: Immersive Learning, Information Technology, Learning Models, Educational Evolution

Introduction

In a changing world where digitalization and technology have and will continue to engrain our everyday lives, education and training is one of the main foundational aspects where IT learning tools can serve educational institutions or harm by its lack of necessity. The latest topics in education today builds around new immersive learning environments, which usually entail 3 Dimensional graphics, computer games, and animation, as well as a whole range of elaborate and wide spread mobile devices of various sizes (that would suit all demographics and contexts) (Ştefan, 2012). However, we question whether all technologies are suitable in bringing a immersive experience?

Ideally, the aim of learning is to genuinely engage and be totally absorbed in an activity where time is perceived to pass very fast (Saade & Bahli, 2005). This cognitive state implies total immersion in the activity and has been shown to be conducive to, and very effective for learning. The advent of Information Technology (IT) and its worldwide use impacted student learning styles and expectation for learning. Consequently, IT has also impacted learning methods and associated pedagogical models which have evolved from basic unidirectional teacher-to-student instruction into a dynamic IT supported and elaborate learning environments (Saade et al., 2011) – At least this is the promise. It is evident today, from the body of research, that more educators are experimenting with IT

for teaching inside and outside the classroom, while at the same time, students are becoming more savvy and critical in assessing and using IT for their learning.

Rooted in the traditional classroom style(s), educators (as part of their profession) are expected to continuously seek teaching and learning improvement to engage all the senses and create more effective elements such as videos, animations and PowerPoint's. However, it seems that classroom experiences continue to be dominated by non-interactive passive learning, especially at the PhD level. However, there is a debate also around the notion that not all immersive environments are created for learning. Some for example are simply to have fun, and improve some tactile skills and strategic thinking, and are not targeting the acquisition of knowledge per se. In that respect, researchers must be careful in addressing the knowledge (or subject matter) component of the immersive learning process and environment. It is exactly with this in mind that this article presents a link between immersive environment and knowledge acquisition.

In response to the need to utilize IT's potential and resources to enhance the learning environment, we considered in this article the concept of immersive learning and its fundamental elements necessary for the acquisition of knowledge. Our proposed methodology tests a web-based learning tool (that meets the immersive learning element) was inspired by past research on innovative technologies in immersive learning (Van Schaik, P., Martin, S., & Vallance, M. (2012). We will take an exploratory perspective allowing the improvement of our tools. The learning platform was used in a Ph.D class on "Pedagogical Methods". We describe the whole process and present the results. We conclude by elaborating on the potential of such innovative learning tools that can be used in-class or online.

Literature Review

We provide herein a literature review that we conducted as we scan the body of knowledge and seek to understand various styles of learning (that can be used to construct immersive learning activities) such as experiential, constructivist and collaborative, which we believe, together in some combination can provide interesting and effective opportunities for IT to create and engage students in an immersive learning environment. We examine various literature introducing advanced technological inventions of virtual reality used in an immersive learning experience to then blend the importance of learning styles with technology and suggest future research ideas to contribute to the theory.

Previous research indicates active learning strategies are more effective than traditional passive learning styles (Inks, and Avila 2008, Saade et al., 2008). As education is relevant for institutions such as elementary, secondary, university and higher education, education is also relevant in training within the professional world (such as professional selling, manufacturing services, entrepreneurship) where new course delivery methods (such as hybrid, web-based courses) are used based on cost, time effectiveness, quality of the learning experience and individual learning styles and needs. As authors Auster and Wylie (2006) developed a systematic approach to active learning, they include four interrelated dimensions of the teaching process such as context setting, class preparation, class delivery and continuous improvement.

Immersive learning, which can be considered as an active learning strategy, is complemented by various learning styles. Auster and Wylie's (2006) context setting involves the establishment of an atmosphere for learning that facilitates student

interaction and engagement. Referring to Inks and Avila (2008), engagement relates to the quality and effectiveness of the learning experience where people learn better when they are fully engaged. It requires students to participate in discussions, reflect on their thoughts, solve problems, and be present in activities by which the learner is required to go through a cognitive process of new information presented. An effective, high quality context atmosphere requires a lot of monetary investment, by which researchers use technologies such as virtual realities with gamification and strategies to create an enticing environment for students to immerse in and learn. Not only should the environment be attractive but accessible to all those who wish to learn at low cost, otherwise true experiential learning may incur a high cost such as travelling expenses, extended time for readiness to experience, or investment in risky efforts which may not result in the experience intended.

At the K-12 levels, the creation of content for learning, and the ability for educators to represent abstract content such as physics and mathematics in a motivated environment contributes to increasing class involvement (Bobbitt, Inks, Kemp, & Mayo, 2000; Young, 2005), critical thinking (Klebba & Hamilton, 2007; Roy, 2005; Sautter, 2007), and greater retention of subject content which also increases the confidence of the student involved. In terms of class delivery, from PowerPoint to blackboard and chalk, the world has evolved into greater graphical delivery content such as 3 dimensional virtual realities which provoke a higher interaction of the content with the student using behavioral elements such as tactile, vision and auditory senses.

With respect to learning styles, it is worth noting that passive traditional learning styles create hurdles in customizing learning content for each student as their behaviors differ and their retention of the information vary from one person to another. With the start of web-based interactive content, allowing students to learn at their own pace, students and teachers can receive feedback and act in seeking continuous improvement such as coming back to a lecture, reviewing unclear content. Many learning management systems today monitor improvements on a regular basis.

Considering the above discussion, defining “immersive learning” can be problematic as it attaches itself to experiential, constructivist, and collaborative elements found in various activities designed to engage the participant. The literature always refers to “immersive learning” as it relates to a specific context and in the presence and facilitation of some form of information technology. In this research study, our literature review revealed that there are three primary perspectives at which “immersive learning” is utilized: In an experiential environment; through a constructivist method; and via active collaboration.

Experiential Immersive Learning (EIL) is represented by activities that allow students to immerse themselves in an artificially constructed world (virtual world) that may resemble reality. As Johnson and Levine (2008) describe, virtual worlds such as Second Life allow students to become part of a constructed world, interact with the virtual environment and learn from simulated experiences automatically created or arising based on a specific series of interactions. (Milgram et al., 1994 ; Ştefan, 2012). Students interactions in EIL with elements such as people, activities, quests, tasks, objects and other simulated artifacts present an opportunity that may be hard to create in

the real world due to expenses and/or risks (Inks & Avila 2008). For example, students can visit a Nano scale environment in 3 dimensions to examine a photon and travel through a lesson in particles of physics delivered by an avatar of Einstein (Johnson & Levine 2008). This experience provides students with a different view of the subject matter, both memorable and illuminating that the traditional classroom was not able to offer. It is also an environment where students can manipulate the parameters of their studies by creating visual effects in real time. EIL is very rewarding and engaging as immersing technologies including virtual reality and collaborative/social systems are now giving students and institutions access to a cost effective customized learning platform solutions (North, 2014).

Using the *constructivist learning method*, students are provided with opportunities to learn at their own pace. A constructivist online experience can be created today by customizing an environment designed by difficulty levels taking into consideration a student's prior knowledge and questioning these students on their unique misconceptions of a subject matter. To that effect, constructivism entails an interesting reflective and introspective element to learning, which entails the processing of knowledge that needs to be gained and assimilated. In an environment where instructors have the ability to create a personal connection, they can engage students in the reflective activities by observation and test them on abstract conceptualization of a specific subject matter, whereby knowledge contained within the activity may be guided or scaffolded. As a method of customization, information technologies allow educators to manage student's opinions, contributions, behavior, motion etc..., which may then update the environment in real time (Biocca & Delaney 1995). In constructivist-based online learning tools, teachers can

monitor the learning process of their students. Students can be allowed to be autonomous in their learning such that they can freely travel in the environment, interact with other students, and acquire information of interest while teachers can receive feedback on their students conscious and unconscious learning progress (Fernandes, Raja, & Eyre 2003).

Social or Collaborative learning (an activity that is very popular today with all the social networking websites) allows students to capitalize on the opportunity to share and learn from each other. Interactivity plays a crucial role in the world of immersive learning, as Kalay (2004) expressed, virtual surroundings allow group learning, similar to a class physical experience, where they are aware of the social process of learning and are affected by the presence and behavior of their peers. Technologies facilitate spatial and process visualization, which allows students to discover time sensitive and cultural backgrounds through graphical reconstructions (Ştefan, 2012).

To that effect, collaborative online learning tools become an asset for individuals to create working spaces for distant learners where they can meet, network, exchange experiences and knowledge (Darvasi, 2008). The promised network is from student to student but also student to teacher as well as teacher-to-teacher in a global setting (North, 2014).

Immersive learning that draws on IT support, social networking and gamification rely heavily on technological and process-driven advances that are rich in user interfaces, represent realistic situations, represent complex pedagogical processes and the creation of an environment where students can engage and immerse themselves into experiences that fosters learning.

Methodology

The Context

Our methodology in testing this learning tool came from an exploratory perspective where our goal was to evaluate students engagement and experience level at multiple levels of academic learning. Many recent research have taken an interest in immersive learning tools mainly Dede, C. (2012), Van Schaik, P. et al (2012), Dawley, L., and Dede, C. (2015). Our methodology in using both quantitative and qualitative observations follows previous examples.

A peer to peer (P2P) learning tool is a web-based interactive system used for student learning and assessment. It facilitates a process of knowledge creation, knowledge evaluation and synthesis, and assessment of knowledge gained (learned). The P2P tool was used in a PhD level course (Pedagogical Methods), in the John Molson School of Business, Concordia University, Montreal, Quebec, Canada. This course is mandatory, for PhD students to learn how to become skillful, thoughtful and confident instructors in any teaching and learning setting. The course tasks aim to enable the student to design effective courses that they would be required to teach, to help them acquire deep approaches to learning, and to improve their teaching effectiveness.

Readings and reference material that draw on seminal work in educational theory and practice are discussed and students learn to provide a conceptual framework to construct and refine pedagogical choices for different audiences. At a theoretical level, learning of the course content (primarily behaviorism, cognitivism and constructivism) revolves on the engagement of students at all four bloom levels. Classes are task-oriented. Tasks emphasize collaboration, reflection, and action. By the end of the course

students are expected to have developed a Teaching Philosophy Statement, Course Outline, taught in a real class setting, and learned about signature pedagogies that have a high educational impact. Of great importance, is that students engage in discussion about exploring and reflecting on their personality traits, and teaching styles with association to teaching and pedagogical methods that would be appropriately aligned. The learning goals of the course are:

- Articulate student own teaching philosophy and elements of a teaching strategy statement,
- Evaluate good practices in teaching and qualities of highly effective teachers in students' respective area of specialization,
- Lead discussions and teach in ways that promote the conceptual knowledge and follow effective practice,
- Apply basic instructional design elements to construct a course,
- Experience active learning techniques, and Enhance communication, presentation skills and drama as means of connecting with the audience.

The Process

The P2P tool involves three phases that encourage the active participation of students. *Phase 1* involves the system presenting the students with a peer-refereed article (in the present case, an article published in an educational psychology journal) related to pedagogy. Students are given a specific amount of time to read the article. In the present case, the subject matter of the article has already been discussed in class, in previous lectures. When ready, the students are required to submit a predetermined number of questions. Students are instructed to create questions whose answers can be found in the article and should be theoretical in nature. When all students submit their questions, this phase is closed. *Phase 2* starts with the P2P tool randomly providing each student with a

random set of predetermined number of questions generated by their peers in phase 1, for evaluation. The P2P tool ensures that students do not get their own questions for evaluation and only their peer's questions. The number of questions each student receives is calculated by the P2P tool and is based on the number of evaluation per question set by the teacher. In other words, the teacher decides on the number of evaluations that need to be done to each question to determine a consensus or agreement on the evaluation variable in question. With each student rating each other's questions according to two variables, namely their perception of the level of difficulty each question possesses and level of quality, the P2P will end up containing a significant number of evaluated questions that represent a body of knowledge to be learned. Therefore, if a question is not clear or even has a typing error or is grammatically incorrect, the students may rate it as low quality. The scales for both difficulty and quality are low, moderate and high.

After all the questions have been assessed, *Phase 3* is opened. While the students take a small break, the teacher can create one or more tests. In this phase, the pool of student generated questions will then be used to create online tests/quizzes. The teacher has the option to create tests from different groups of students and assign it to other groups of students. We would like to note that the student profiles include their ethnic background and gender. This is important because in this phase, the professor can create a test by specifying from which sub-pool of questions (those generated by male/female and/or specific ethnic background) to select the test, and specifying which sub-group of students (gender and ethnic background) to take the test.

During this P2P learning process, students are encouraged to provide high quality questions by receiving additional marks should their questions be chosen to appear in the

quiz. The questions are randomized such that each student receives different questions with an equal amount of easy, moderate and difficult level questions.

Immersive Elements of the P2P Tool

The emphasis of the P2P learning tool on student-centered teaching, where the student is responsible for his/her own construction of knowledge seems to be reflected well in this tool. For example, students must develop their own questions which they then submit for peer rating. To be able to formulate questions, students must have a deeper understanding of the subject matter. In addition, to be able to determine or rate the submitted questions, students must also show a deeper understanding of the subject matter. It has been said that the best way to ensure that you understand a topic is to try to teach it to someone else. In order to do this, one needs to be able to formulate questions.

The P2P learning tool includes elements that are experiential, constructivist and collaborative. These elements have been elaborated in the literature review section above. In this section, we map those elements to the P2P components / processes / phases. The following immersive elements are mapped to the P2P tools keeping in mind that students while using the tool are playing the roles of the teacher, evaluator and learner (TEL), depending on the time and place (phases and tasks) they are engaged in.

Experiential:

- Students become part of the TEL constructed world, interacting via the tool environment and learn from simulated experiences as their tasks change depending on the role they are engaged in – teacher, evaluator, learner.
- Students interact with other students, tasks, documents, websites, articles, and knowledge artifacts managed by the tool.

- Students can manipulate the parameters of the knowledge creation process by viewing other student's created knowledge and provide assessment of that knowledge.

This experience of creating knowledge, evaluating that knowledge, and assessing their learning provides students with a different view of the subject matter, as well as insight into other student's thinking of the same subject matter that are both more memorable and illuminating than traditional methods which are not able to offer.

Constructivist:

- The P2P activity can be done virtually or in the classroom. In either case, enough time can be given to students to complete the tasks and learn at their own pace.
- An environment designed in consideration of a student's prior knowledge and questioning these students on their level of understanding of the subject matter at hand.
- Includes reflective and introspective element to their learning, which occurs during and entails the processing of knowledge that needs to be gained and assimilated.
- The instructor can create a personal connection by engaging students in the reflective activities and test them on the subject matter.
- As part of customization, educators to manage student's contributions, behavior, and knowledge acquisition, which updates the environment (in phase 2 for example) in real time.
- Teachers can monitor the learning process of their students by seeing their contributions in each phase in real time, and in the case of a classroom setting, the teacher can interact with the students and provide feedback in real time.

According to Hoy et al (2013), constructivists argue that learning needs to be looked at from the student's perspective. Thus if the questions are coming from the

students, then they are the ones asking the questions which they find pertinent to their learning process. This is another indication of how this tool is based in the constructivism theory of learning.

Furthermore, constructivists argued that letting students direct the questioning and discussion that takes place in the classroom would result in more meaningful learning from the students' perspectives. In this case, the classroom may be online and the social ties necessary for learning to take place per this view are virtual, however, the creating of the questions and the rating of each other's work, still makes for meaningful learning for the students.

Collaborative learning:

- Students capitalize on the opportunity to share and learn from each other, by evaluating the knowledge created by others (phase 2) and reflecting on the evaluation of others on their own work (phase 3).
- Students are aware of the process of learning, the role they are playing in every phase, and are affected by the presence and behavior of their peers.
- The P2P facilitates the process of visualizing the student's role and tasks to be done in each phase, which allows them to discover knowledge sensitive backgrounds.

In summary, this teaching tool seems to be supported by the constructivist and cognitivist theory of learning since it allows students to direct their own learning based on their own integration of knowledge and their ability to direct the questioning.

Results and Discussion

The use of the P2P learning tool generates several objective data and knowledge as described above. The results used for analysis entail the outputs from each phase,

primarily the questions, questions level of difficulty, questions level of quality, test characteristics, and student test performance. In this section, we present the analysis of the P2P outputs and we also provide further insight on the student engagement and assessment using the item response theory.

Peer Evaluations of Questions Generated

This section of results provided a greater understanding of the eco-system created by the tool for the students. We gain a better understanding on the quality of questions created by students. Within these questions, they allow us to define the styles of learning within an IT tool and validate its usefulness in learning.

The class with 15 students generated 140 questions in phase 1, and in phase 2 they were asked to assess 25 questions. In this case, each question was assessed by 4 students. The mean level of quality (figures 1, 2 and 3) and difficulty (figures 4, 5 and 6) for each of the 140 questions have been organized in frequency diagrams shown below, for tolerance levels 3 or more, 4 or more and 5 or more, respectively.

Results indicate that the mean level of quality (figures 1, 2, and 3) of the total number of questions generated is 2 (on a scale from 1 to 3) with a standard deviation of 0.4. The modal class is the level from 2.0 to less than 2.5 with a 56% frequency.

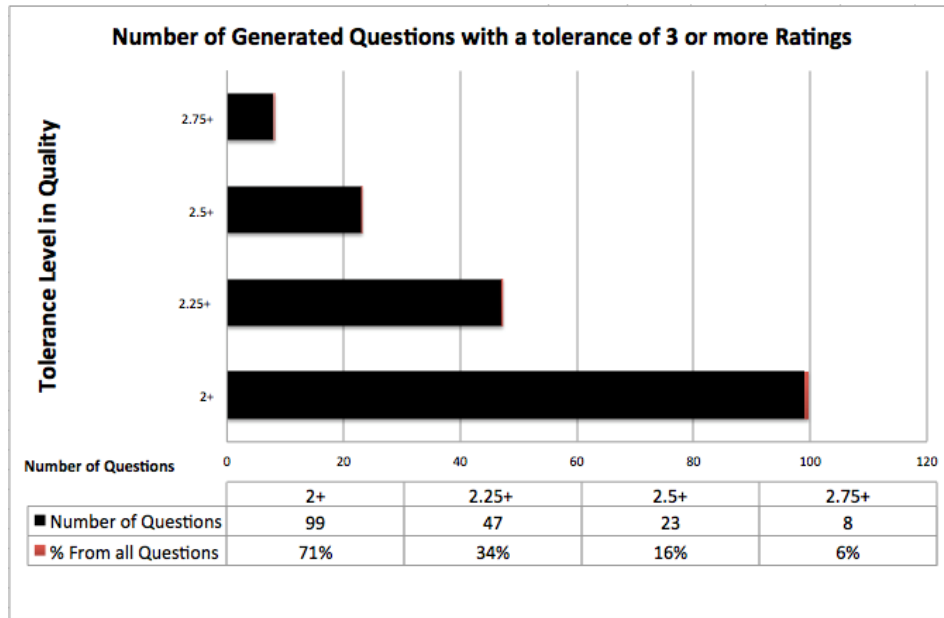

Figure 1. Questions evaluation of level of quality – with 3 or more ratings.

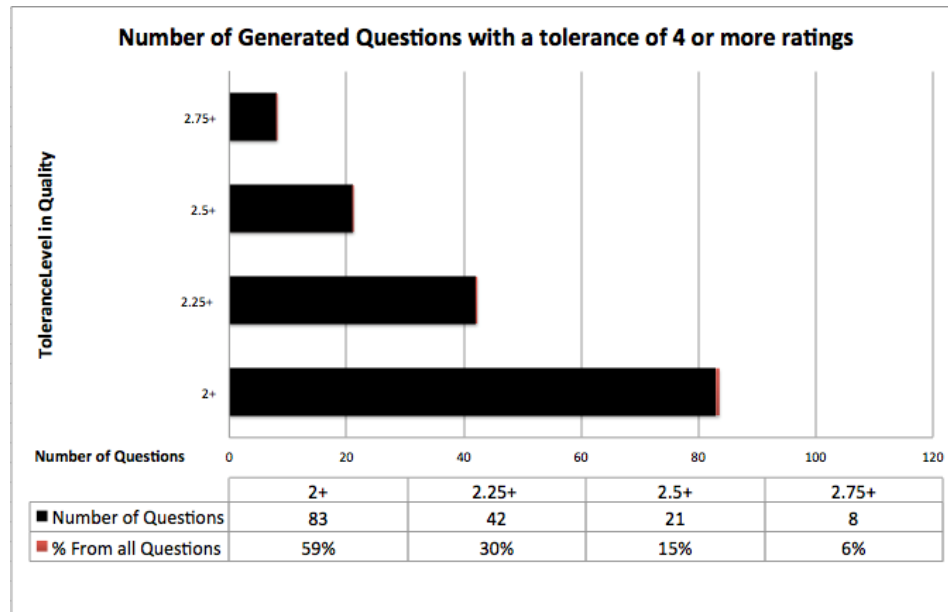

Figure 2. Questions evaluation of level of quality – with 4 or more ratings.

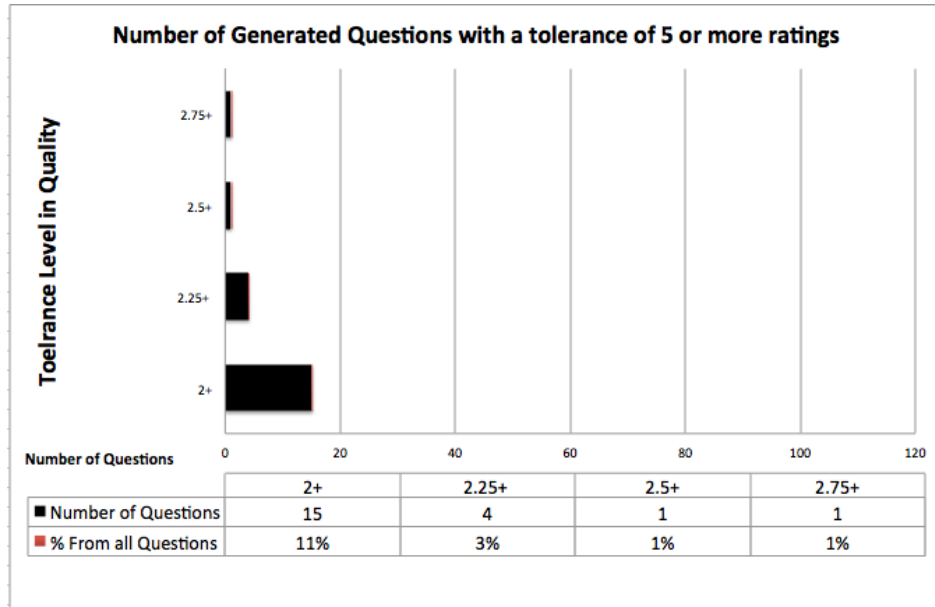

Figure 3. Questions evaluation of level of quality – with 5 or more ratings.

Moreover, results indicate that the mean level of generated questions difficulty (figures 4, 5, and 6) is 2 (on a scale of 1 to 3) with a standard deviation of 0.4. The modal class is the level from 2.0 to less than 2.5 with a 46% frequency

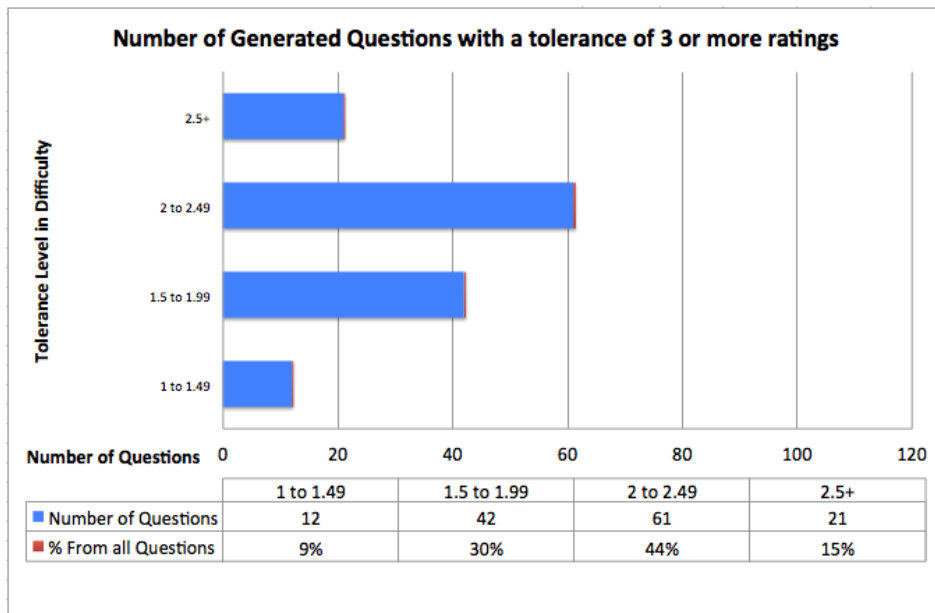

Figure 4. Questions evaluation of level of difficulty – with 3 or more ratings.

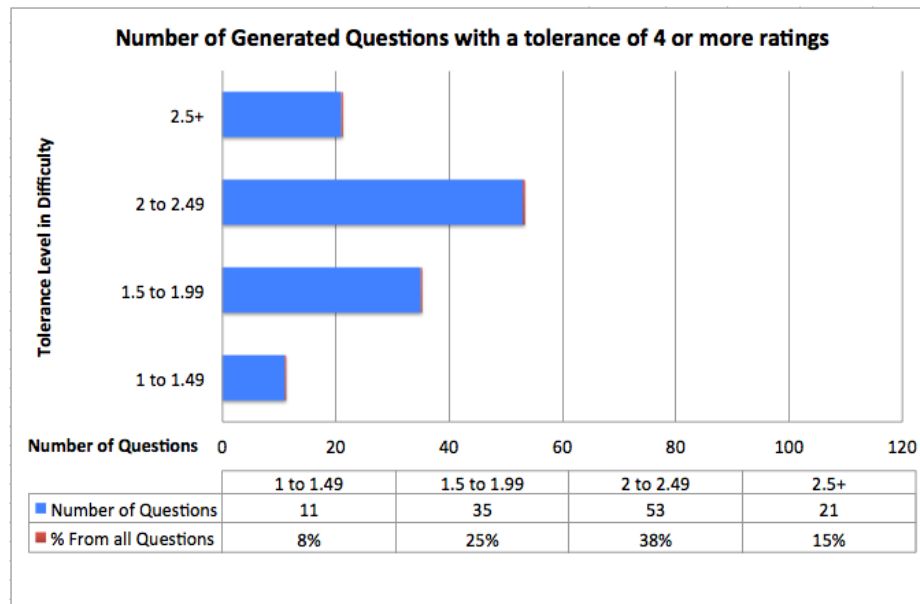

Figure 5 Questions evaluation of level of difficulty – with 4 or more ratings.

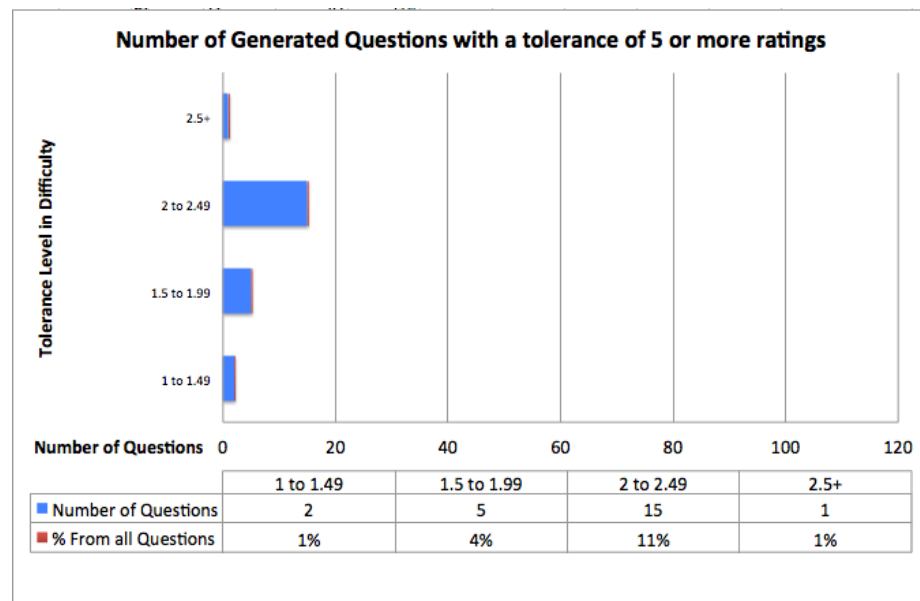

Figure 6 Questions evaluation of level of difficulty – with 5 or more ratings.

In an attempt to better understand the quality to difficulty relationship of total number of questions generated, we performed a simple correlation analysis between them. We found that the coefficient of correlation between the Level of Difficulty and the Level of Quality is 0.309, which means that as the level of difficulty increases, the level of the quality of the question also increases. This is actually a desirable effect, however more studies need to be done to confirm the validity of this finding or rule out secondary perceptions effects.

Test Characteristics & Results

Figures 6 and 7 below present the level of difficulty and level of quality for test generated by the professor, in Phase 3, respectively. The questions are presented in the appendix at the end of the article. In the appendix, the last column to the right represents the total number of ranking for each question (TR). We present this table so the reader can assess the questions generated. These questions were not edited by the professor, for the purpose of simulating a completely peer to peer driven activity with no professor intervention. The entire idea behind the P2P tool is based on the premise that the professor does not intervene in the knowledge creation, acquisition and assessment process and that self-directed peer to peer learning is possible. All these questions were multiple choice.

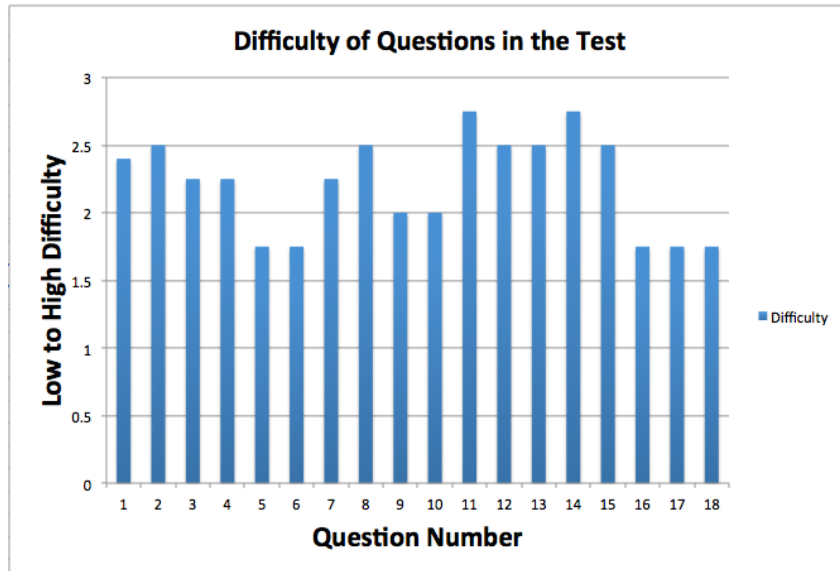

Figure 6. Questions evaluation of level of quality – with 5 or more ratings.

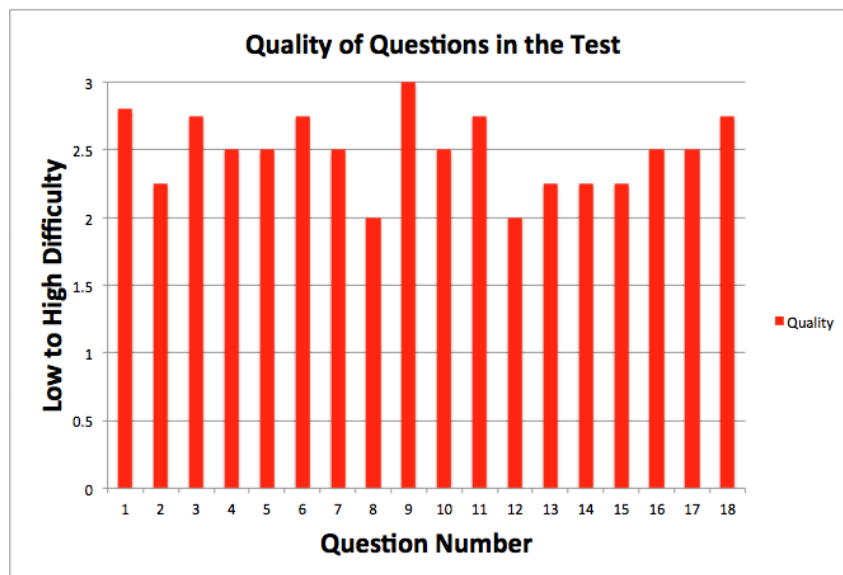

Figure 7. Questions evaluation of level of quality – with 5 or more ratings.

It is evident from figures 6 and 7 that the P2P tool was able to generate questions whereby question’s difficulty and quality are well distributed. In other words, there is a clear benchmark for quality which is at level 2 such that all questions in the test were of high quality. Moreover, with respect to the level of difficulty, the number of questions

selected from the pool at levels 1.75, 2.0, 2.25, 2.5, and 2.75 were 5, 2, 3, 6, and 2, respectively. These are favorable results of the P2P tool which was able to generate a test with questions at 5 different levels of difficulty while maintaining a high level of quality.

Table 1 presents the results of the test showing the time taken by every student to complete the test and corresponding score, where we explore possible relationship between score and duration. Out of the 15 students, only 9 participated since this was a pilot, and the activity was not mandatory.

Table 1. Student test results.

Student	Duration (Min)	Duration (hrs)	Score, %
1	28	0.5	93
2	41	0.7	80
3	42	0.7	77
4	73	1.2	80
5	245	4.1	70
6	695	11.6	80
7	1614	26.9	83
8	5471	91.2	80
9	5889	98.1	73

It is interesting to note that the duration for doing the test (which was open) ranged from 28 minutes to 98 hours (or 4 days). Since the test was open and the test included questions from one article in educational psychology, table 4 results provide insight on how students strategized to do the test. Those who did the test within one hour or so may have studied the article first (the professor's original intention) then simply did the test. On the other hand, students who took more time to complete the test were

referring to the article as they answered each question. Students who did the test over a duration of days, may have done some questions, kept the screen open then came back to complete other questions. What is interesting, is that as we go down the records in table 4 from student 1 to student 9, we observe a tendency of decreasing performance. The following two figures attempt to assess that.

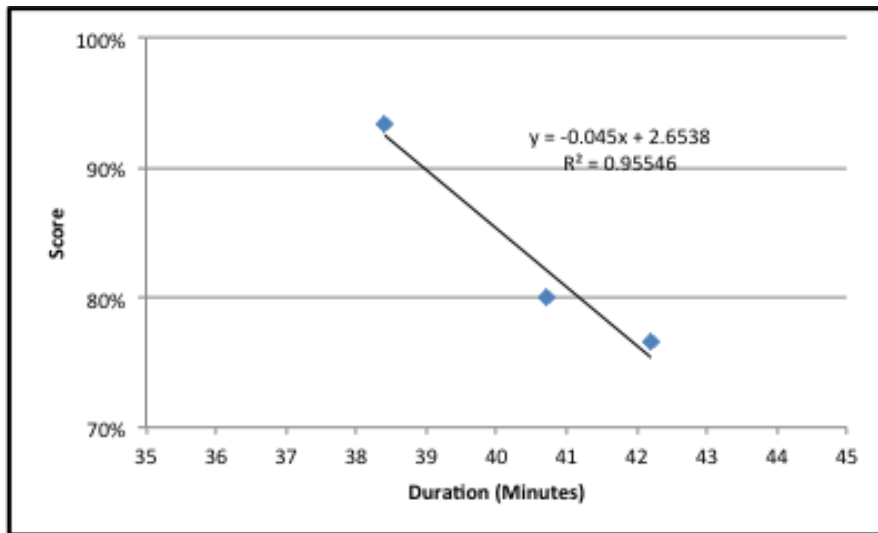

Figure 8. Performance trend of type A students.

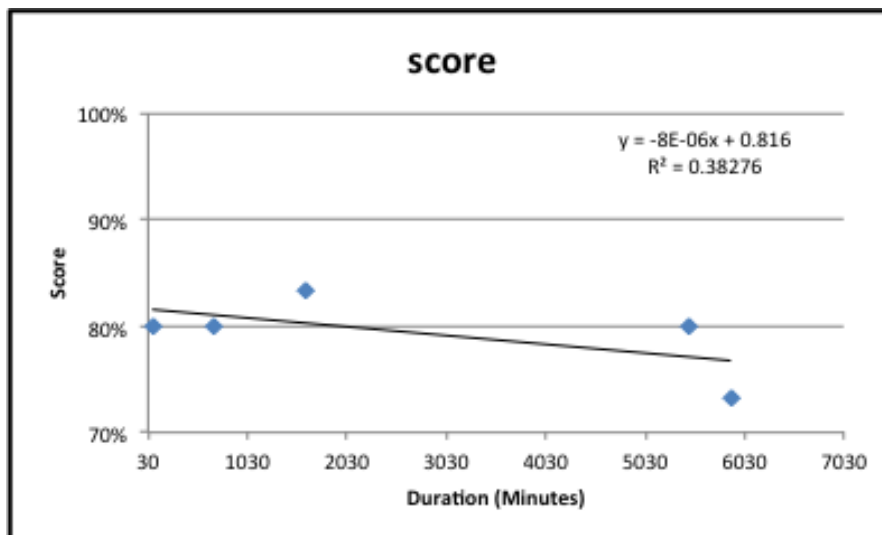

Figure 9. Performance trend of type B students.

To analyze performance, we split the 9 students into two groups: group A and group B where group A (figure 8) are those who did the test within an hour implying that these student studied first then did the test back-to-back; while group B (figure 9) are those who possibly did the questions while referring to the article and where they may have stopped and came back to complete another set of questions at a later time.

Both figures clearly show that students, who take more time to complete an exam, also seem to score less. This phenomenon has been previously observed and reported. This trend is significant for group A students with R^2 close to 96% (we acknowledge that 3 cases do not make a conclusion, but the results point to interesting phenomenon which begs further research). The contrary is found for group B students: The slope of the line fit (change in score with increasing duration) is not significant with R^2 close to 38%. In other words, no matter how long a student keeps reviewing the article to figure out the best answer, the result or selection of the answer would be the same. This result alludes to the fact that the student's understanding of the article (subject matter) and synthesis of knowledge contained (in the present context of course) has plateaued. Any increase in performance would require the intervention of the professor via other activities. So, for example, if this article was the discussed in class in-depth and students were asked to take the test again, the overall performance of the group would be expected to increase. On the other hand, students in group B may have not been motivated to participate in the activity resulting in such performance outcome.

Item Response Theory Analysis

In this section, we attempted to understand the students performance at a deeper level which relates to their cohort. The advantages in utilizing an IT tool allows us to see the progression and identify students ability to answer question, but also their ability to be critical about questions and options available to them.

Due to the context of this study, we identify the item response theory (IRT) (Santor, 1998) as an appropriate method of analysis. In this sub-section, we present an analysis of the student test data using the IRT. In the present context, the sample is too small to perform standard statistical analysis such as regression and correlations. Our goal is to understand the impact of the P2P tool as an immersive environment, on the learning of the student vis-a-vis their knowledge processing. The IRT seems to be a possible and justifiable method of analysis to meet this goal.

The method of IRT analyzes specifically each question answered by the students, instead of looking at their total score which represents the total aggregated assessment of their knowledge but lacks insight into their ability to process the knowledge to be gained. The analysis allows us to look at expected answers providing information for future examinations of the same type. In order to create results, we used Testgraf to generate responses. Testgraf is a software created by Professor Jim Ramsay from McGill University as an aid to the development, evaluation and the use of multiple-choice examinations as well as for psychological scales and questionnaires (Ramsay, 2000).

We select two students with different test scores for IRT analysis. Student # 7 scored 15/18 (83.33%). Figure 10 shows the relative credibility curve of this student which illustrate their actual scores, and their expected scores. On the x – axis is the actual score of the student (vertical straight line), on the y-axis, is the credibility factor of the

student, if this student were to retake another exam of the same type. Credibility is a measure of a student's true proficiency level. Based on the student's option choices in the test, wrong and right, the credibility curve shows the range in which the students will perform if a similar test is taken. When the curve reaches credibility of 1, the value of the test grade is the maximum likelihood estimate of the student's proficiency.

In comparison with the rest of the class, this student ranked in the higher 95% of the class. The corresponding credibility factor also shows that if the student were to retake a test of the same type, this student's performance would range from 10 to 14. Since its maximum likelihood approaches the credibility of 1, it means this student's performance is consistent.

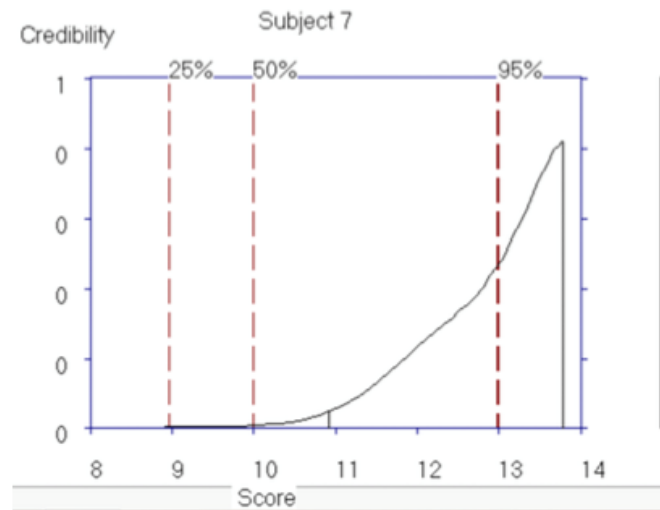

Figure 10. Analysis of student 7.

In comparison, Student # 8 (see figure 11) scored 10/18 (70%) ranking him a little lower than 50% of the class. His expected score would range from 9 to 13, although

looking at his maximum likelihood estimate of proficiency, his performance may fluctuate and show less consistency if a similar examination is taken.

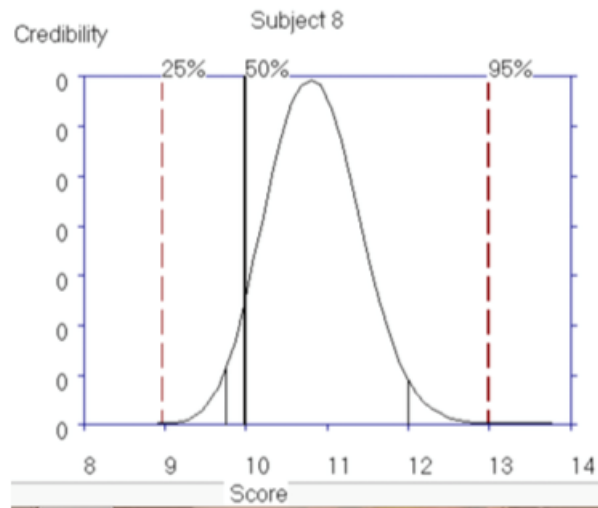

Figure 11. Analysis of student 8.

Inputting the sequential question answers of the students into Testgraf, we are able to generate an analysis per question item, per student and an overview of the test performance. IRT allows test evaluators to check for discrimination within an exam, such that whether a question is differentiating a strong student from the weaker students and whether the questions are balanced in terms of difficulty level.

The IRT can also provide us with insight into the question's performance as it relates to the group of students by analyzing the standard error of questions (answered right or wrong) as they relate to student's performance. Figure 12 shows the standard error between right (green line) and wrong (red line) answers obtained from the test results of all the students. A large fluctuation (variation) exists for students who scored in the 50th to 85th percentile, meaning their wrong answers were not always the same. While students who scored over 95th, or below 25th percentile, have a lower fluctuation in

their performance as represented by their scores. In other words, for students who excel or do poorly, the difference in their answers as compared with each other varies little.

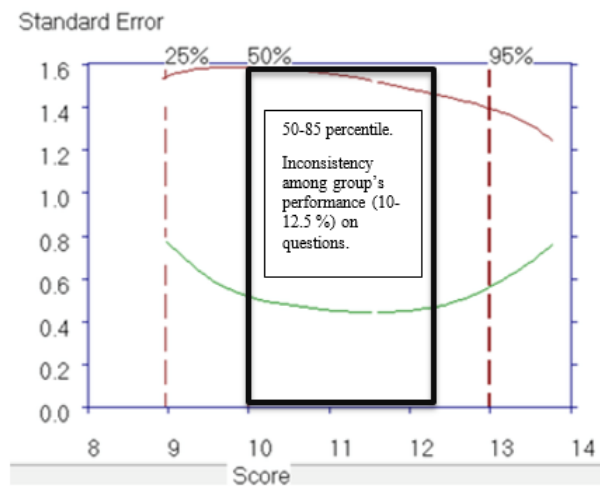

Figure 12. Standard error between right and wrong.

Future Research and Conclusions

Throughout the literature, immersive learning showcases many advantages to improve current learning, not only do virtual realities allow possibilities of visualizing environment that a human cannot see in real life, virtual realities creates an interactive nature which allows knowledge to be spread quickly, effectively and globally. Through the four dimensions of the teaching process (context setting, class preparation, class delivery and continuous improvement) and the three styles of learning (Experiential, Constructivist, Collaborative), these elements all contribute into the use of virtual realities as tools to utilize immersive learning as an upcoming, important learning style. In this proposal, as the literature on immersive learning is still at its beginning, many perspectives can be explored as we suggest further investigation into the use of human senses such as tactile, olfactory, auditory, visual and gustatory as an integration to creating immersive learning styles.

At the moment, virtual realities only touch on tactile, auditory and visual senses, however, based on branding literature and psychology research of senses, olfactory is one of the most powerful senses in creating memories (Anggie & Haryanto, 2011) at the conscious and unconscious level. The olfactory sense combined with all four senses creates an experience for students to immerse into a learning environment. In addition, gustatory sense compliments all other senses as the smell influences the taste perception (Krishna, Morrin, & Sayin, 2014), which in turn influences the perception of an object, an environment and a product. To support this proposition, Summers, Reiff and Weber (2008) have shown the relevance of using more modalities in learning styles, do make the process more effective.

While Nokia has presented a multi-sensory communications devices (Hultén, 2011), similar branding strategies can be created towards education as the cognitive, behavioral processes are the same in gaining attention, creating retention. The popularity and necessity of virtual realities will become the default method for representing problems (Jonassen, 1999). This invention, with multiple assets such as having a collaborative, interactive nature can be enhanced to multiple modalities, multi-sensory learning styles. This platform also adds freedom and decision making potential (Darvasi 2008), representation of both abstract and concepts material, while allowing individuals to have a presences (Dickey 2003) in a world they could have never imagined existed in a cost effective, high quality and motivating environment.

In the present study, we aimed at creating an innovative pedagogical method that utilizes IT and the web to help engage students in different ways. The resulting P2P learning tool design process can be linked to the constructivist and cognitivist approaches

and provides a wide range of learning opportunities by changing the configuration setup. Through these combinations, the tool allows students to be immersed in the activity of capturing and synthesizing relevant information.

We presented herein a pilot study using the P2P learning tool and executed in a PhD class. The results were interesting as they revealed a number of insights namely:

- That students engaged with each other (~constructivism)
- That students engaged with subject matter (~cognitivism)
- That spending more time on a test is not a guarantee to perform better
- The P2P learning tool
 - can be very effective
 - has an immersive learning element in its design and process
 - can be utilized for learning and assessment at the same time

Our contribution in this paper sheds light on a collaborative learning tool tested at a doctoral level classroom, which is indicative of future professors' proficiency in creating quality questions. In addition, this tool incorporates and acknowledges past research on experiential, constructivism and collaborative learning as well as immersive features. This study takes the field of innovative technologies in learning one step forward in understanding useful technologies in education that serve knowledge acquisition.

References

- Anggie, Cherish, and Jony Oktavian Haryanto. 2011. "Analysis of the Effect of Olfactory, Approach Behavior, and Experiential Marketing toward Purchase Intention." *Gadjah Mada International Journal of Business* 13: 85–101.
- Auster, Ellen R, and Krista K Wylie. 2006. "Creating Active Learning in the Classroom: A Systematic Approach." *Journal of Management Education* 30: 333–53. doi:10.1177/1052562905283346.
- Biocca, F., and B. Delaney. 1995. "Immersive Virtual Reality Technology." *Communication in the Age of Virtual Reality*, 57–124.
- Bobbitt, L. M., S. A. Inks, K. J. Kemp, and D. T. Mayo. 2000. "Integrating Marketing Courses to Enhance Team-Based Experiential Learning." *Journal of Marketing Education*. doi:10.1177/0273475300221003.
- Darvasi, P. (2008), Virtual world language learning. wiki site
http://sites.wiki.ubc.ca/etec510/3D_Virtual_Learning_Environments
- Dawley, L., and Dede, C. (2015). Situated learning in virtual worlds and immersive simulations. In J.M Spector, M.D. Merrill, J. Elenm and M.J. Bishop (Eds), *The Handbook of Research for Educational Communications and Technology* (4th ed.). New York: Springer.
- Dede, C. (2012) Customisation in immersive learning environments: Implications for digital teaching platforms. In C. Dede & J. Richards, (Eds). (2012) *Digital Teaching Platforms*. New York: Teacher's College Press.
- Dickey, M. (2003). Teaching in 3D: Pedagogical Affordances and Constraints of 3D Virtual Worlds for Synchronous Distance Learning, *Distance Education*, 24(1), 105-121.
- Driscoll, P.M. (2000). *Psychology of Learning for Instruction*, Allyn&Bacon, Massachusetts.
- E. Von Glasersfeld, Questions and answers about radical constructivism, in: K. Tobin (Ed.), *The Practice of Constructivism in Science Education*, AAAS, Washington, 1993 : 23–38.
- Fernandes, Kiran Jude, Vinesh H. Raja, and Julian Eyre. 2003. "Immersive Learning System for Manufacturing Industries." *Computers in Industry* 51 (1): 31–40. doi:10.1016/S0166-3615(03)00027-7.
- Hoy, A. W., Davis, H.A., Anderman, E.M. (2013). Theories of learning and teaching in TIP. *The College of Education and Human Ecology, The Ohio State University*. 52, p. 9-21.
- Hultén, Bertil. 2011. "Sensory Marketing: The Multi-sensory Brand-experience Concept." *European Business Review* 23 (3): 256–73. doi:10.1108/09555341111130245.
- Inks, Scott A., and Ramon A. Avila. 2008. "Preparing the next Generation of Sales Professionals through Social, Experiential, and Immersive Learning Experiences." *Journal for Advancement of Marketing Education* 13 (4): 47–55. <http://www.mmaglobal.org/JAME-Archive/JAME-Winter-2008/JAMEWinter2008v.13p.47-55.pdf>.
- Johnson, Laurence F., and Alan H. Levine. 2008. "Virtual Worlds: Inherently Immersive, Highly Social Learning Spaces." *Theory Into Practice* 47 (2): 161–70. doi:10.1080/00405840801992397.
- Jonassen, D. 1999. "Designing Constructivist Learning Environments." In *Instructional-Design Theories and Models*, 2:215–39.
- Kalay, Y E. 2004. "Virtual Learning Environments." *Journal of Information Technology in Construction (ITcon)* 9: 195–207. <http://www.itcon.org/2004/13/\n\Library\Kalay2004.pdf>.
- Klebba, J. M., and J. G. Hamilton. 2007. "Structured Case Analysis: Developing Critical Thinking Skills in a Marketing Case Course." *Journal of Marketing Education*. doi:10.1177/0273475307302015.
- Krishna, Aradhna, Maureen Morrin, and Eda Sayin. 2014. "Smellizing Cookies and Salivating: A Focus on Olfactory Imagery." *Journal of Consumer Research* 41 (1): 18–34. doi:10.1086/674664.
- Milgram, Paul, and Fumio Kishino. 1994. "Taxonomy of Mixed Reality Visual Displays." *IEICE Transactions on Information and Systems* E77-D: 1321–29. doi:10.1.1.102.4646.
- Milgram, Paul, Haruo Takemura, Akira Ustimi, and Fumio Kishino. 1994. "Augmented Reality: A Class of Display on the Reality-Virtuality Continuum." *Telem manipulator and Telepresence Technologies* 2351: 282–92.

- Mujber, T.S., T. Szecsi, and M.S.J. Hashmi. 2004. "Virtual Reality Applications in Manufacturing Process Simulation." *Journal of Materials Processing Technology* 155-156 (November): 1834–38. doi:10.1016/j.jmatprotec.2004.04.401.
- North, Max M. 2014. "Distance Learning Immersive Environments: Sense of Presence Exploration." *Journal of Visual Languages & Computing*, October. doi:10.1016/j.jvlc.2014.09.006.
- Ramsay, J. O. (2000). TestGraf: A program for the graphical analysis of multiple choice test and questionnaire data [Computer Program / Windows Version], Montreal, Canada, McGill University.
- Roy, A. 2005. "Debating the Issues: A Tool for Augmenting Critical Thinking Skills of Marketing Students." *Journal of Marketing Education*. doi:10.1177/0273475305280533.
- Sautter, P. 2007. "Designing Discussion Activities to Achieve Desired Learning Outcomes: Choices Using Mode of Delivery and Structure." *Journal of Marketing Education*. doi:10.1177/0273475307302014.
- Ştefan, Livia. 2012. "Immersive Collaborative Environments for Teaching and Learning Traditional Design." *Procedia - Social and Behavioral Sciences* 51: 1056–60. doi:10.1016/j.sbspro.2012.08.287.
- Steuer, Jonathan. 1992. "Defining Virtual Reality: Dimensions Determining Telepresence." *Journal of Communication* 42: 73–93. doi:10.1111/j.1460-2466.1992.tb00812.x.
- Saadé, R., & Bahli, B. (2005). The impact of cognitive absorption on perceived usefulness and perceived ease of use in on-line learning: an extension of the technology acceptance model. *Information & management*, 42(2), 317-327.
- Saade, R., Nebebe, F., & Mak, T. (2011). Knowledge management systems development: Theory and practice. *Interdisciplinary Journal of Information, Knowledge, and Management*, 6, 35-72.
- Saadé, R. G., Tan, W., & Kira, D. (2008). Is usage predictable using belief-attitude-intention paradigm. *Issues in Informing Science and Information Technology*, 5, 591-599.
- Summers, C., P. Reiff, and W. Weber. 2008. "Learning in an Immersive Digital Theater." *Advances in Space Research* 42 (11): 1848–54. doi:10.1016/j.asr.2008.06.018.
- Summers, C., Reiff, P. 2004 Creating full-dome experiences in the new digital planetarium, NASA Office of Space Science Education and Public Outreach Conference, In: Narasimhan, Beck-Winchatz, Hawkins, Runyon (Eds.), ASP Conference Series (319): 374–376.
- Summers, C. A, 2003 "Systemic Sustained Partnership Between a School District and a Museum", Urban Network – Museums Embracing Communities, The Field Museum, Chicago, :97–105.
- Wandersee, James H, Joel J Mintzes, and Joseph D Novak. 1994. "Research on Alternative Conceptions in Science." In *Handbook of Research of Science Teaching and Learning*, 177–210.
- Young, M. R. 2005. "The Motivational Effects of the Classroom Environment in Facilitating Self-Regulated Learning." *Journal of Marketing Education*. doi:10.1177/0273475304273346.
- Santor, D. A., et al. (1998). « Progress in the technology of measurement: Applications of item response models », *Psychological Assessment*, vol.10, no.4.
- Van Schaik, P., Martin, S., & Vallance, M. (2012). Measuring flow experience in an immersive virtual environment for collaborative learning. *Journal of Computer Assisted Learning*, 28(4), 350-365.

Appendix

Table 2. Test questions and associated rankings of quality, difficulty and total number of students that ranked each question (TR).

Question	TR
What variable turned out to be less significant than previous research had shown?	4
The aim of the Connor et al.'s (2014) paper is to test the relationship between (select the correct two)	4
What is the strongest moderator in student academic performance?	5
Which of the following are correct statements about Western and Eastern education?	4
Which of followings is NOT the main objective in this study?	4
According to Connor et al (2014), what source influence children's' learning?	4
Which three are the dimensions of ISI system?	4
According to the authors, which of these variables has received less attention in research and needs further investigation?	4
What are the 3 main domains on which students are tested?	4
What is one of the strongest moderators in students' academic performance?	4
Which of the following is not one of the 10 constructs examined?	4
Which of following variables is not the suggested to investigate in future large-scale international assessment?	4
The study concludes that learning motivation is	4
What coding system is used by Connor et al. (2014)?	4
Which two are parts of code-focused instruction?	4
Students showed the greatest gains in vocabulary and comprehension when	4
True or false: Connor et al.'s (2014) study furthers our understanding of which dimensions of the CLE provides better predictors of learning at the individual student level.	4
According to Li (2012), what are the emphases of Western educational system, on which Eastern educational systems have less emphasis?	4
What are some of the pitfalls of the present study that future studies should address?	4
What is the aim of investigation of this paper (Connor et al (2014)) ?	5
Which of the following is incorrect about Cohen's d?	4
Connor et al(2014) cite which paper to show that measurable variability in the effectiveness of teaching has direct implications for students' success or failure	4
Why is it possible for a student with high quality teacher not to earn desired outcome in language arts?	4
What are the sources of influence on learning in the dynamic systems framework used by Connor et al. (2014)	4
What is the central thesis proposed in Connor et al.'s (2014) article?	4
What are the big concerns of the authors regarding the education system in Asia?	4
What dimensions were the ISI/Pathway rating scale designed to rate?	5
Which of following is NOT a cautionary remarks for the paper suggested by the author?	4

Which of CLE quality or amount/content/type of instruction students received independently predicted student's vocabulary & comprehension gains?	4
What are the workshops the professors receive for their professional training (Connor et al 2014)?	4

APPENDIX E PAPER 2

This paper was presented in Administrative Sciences Association Canada (ASAC) 2017–
Submitted to Decision Sciences: Journal of Innovation in Education.

Title: Understanding of Peer to Peer Learning Using Item Response Theory

Authors:

Samie Li Shang Ly, Concordia University

Marc-Alexandre Tomiuk, HEC Montreal

Raafat Saade, Concordia University

Abstract

Immersive learning is first described as a technology-laden approach whose features can be specified and designed by elements drawn from experiential, constructivist and collaborative forms of learning. Next, a peer to peer interactive web-based learning tool is introduced. This tool was designed in-house and piloted over the duration of a doctoral seminar on ‘Pedagogical Methods’. Implementation of the tool required students to learn a specified subject matter, synthesize the information, formulate questions, and rate their peers’ questions. The data was analyzed using the Item Response Theory (IRT) as a form of analysis which is a highly appropriate tool in the assessment of immersive learning outcomes. Despite the small sample size, examples of IRT output are provided for illustrative purposes.

Introduction

The advent of information technologies, their widespread adoption, and their rapid and continuing evolution have impacted learning styles as well as pedagogical methods and models. Learning and teaching have evolved from traditional unidirectional teacher-to-student instruction to the use of dynamic and elaborate IT supported learning environments. Today, innovative learning environments entail the integration of a wide range of technologies. These swift changes have essentially transformed the ways by which knowledge transfer occurs. These technologies are suited to various demographics and learning contexts and thus allow stakeholders in education to innovate throughout the globe and to facilitate learning in multiple forms (Ştefan, 2012).

Within the realm of traditional classroom teaching strategie(s), educators are expected to continuously improve teaching and learning by implementing the creation and use of videos, animations and PowerPoint presentations. Thus, classroom experiences are still typically shaped through non-interactive and rather passive learning environments. This is especially evident throughout the coursework undertaken by doctoral or PhD level students.

In response to the impetus to more fully utilize the great potentials offered by new technologies and by a variety of innovative resources in order to enhance the learning environment, we first expand on the concept of *immersive learning* and its fundamental elements. Next, we propose an immersive web-based learning tool which was developed in-house and implemented in a PhD class on ‘Pedagogical Methods’. We describe this process which culminated in the generation of a pool of test items and subsequently present statistical analyses of the test items. In particular, the nonparametric Item

Response Theory (IRT) software Testgraf is introduced and positioned as an appropriate and revealing method of analysis. Finally, we conclude this paper with a discussion of the potentials offered by innovative learning tools in the classroom and in virtual settings.

Background

Throughout time, learning has changed from watching and practicing (trial and error) to apprenticeship, assimilation in traditional classrooms, e-learning, and more recently, to immersive learning with the advent and integration of new technologies (Pagano, 2013). The latter draws heavily on IT support and involves various technological features from the digital world which are inherent to games, simulations and virtual environments.

Immersive learning environments are outcrops of these media and are being continually enhanced through the integration of emerging technologies which include game engines, console and alternate reality games, multimedia augmented reality, 3-D environments, avatars, mobile learning, social media platforms, websites, and website development tools. Accordingly, in reference to their notion of *virtuality continuum*, Milgram and Kishino hold that: “as technology progresses, it may eventually become less straightforward to perceive whether the primary world being experienced is in fact predominantly ‘real’ or predominantly ‘virtual’ ...” (p. 1322).

The goal of immersive learning is skill enhancement and performance improvement in a particular context via technologically enriched and engaging designs whose features emulate real world environments. For instance, the website Cooleimmersive.com provides a typical description of immersive learning applications:

“Immersive Learning is a relatively new term, describing the use of computer-gaming technologies to create highly engaging simulation-based learning environments. These virtual environments emotionally engage people through the use of adventure or strategy. Players learn as they play, with progress checkpoints acting as a platform for knowledge and content assessment. Learners learn-by-doing, and can experience the consequences of bad decisions. They need to apply critical thinking to solve problems much as an airline pilot learns how to deal with an event that cannot be safely replicated in the real world.” (cooleimmersive.com , 2017)

Traditional methods of learning and teaching in classrooms are generally considered to be passive in character and have been criticized for their inability to stimulate engagement on the part of students (Cai, Tai and Ngo, 2013). On the other hand, immersive learning represents an active learning modality with great potential to far surpass traditional tutor-to-learner modes of knowledge transfer (de Freitas et al. , 2010). Although the superiority of active over passive learning modalities is often presumed, it has been difficult to quantify and to demonstrate empirically (Whetten and Clark, 1996).

In any case, Auster and Wylie (2006) have suggested four dimensions which are deemed necessary for effective learning: 1) context setting, 2) class preparation, 3) class delivery, and 4) continuous improvement. In particular, *context setting* involves the establishment of a climate for learning that facilitates student interaction and engagement. In turn, *engagement* requires students to actively participate in discussions, reflect on their thoughts, solve problems, and partake in activities (Inks and Avila, 2008). Both context setting and engagement are of primordial importance to immersive learning.

Accordingly, Vuk, Takol and Vogrinc (2015) hold that the term *immersion* “defines a mental condition in which consciousness of the physical ‘I’ vanishes or is lost in thoroughly penetrating the environment. The experience of immersion includes total presence and separation from the external physical world, deep inclusion and preoccupation; it provides information or multiple-sensory stimulation” (p. 53).

Accordingly, various styles of learning including the experiential, constructivist and collaborative can be integrated in efforts to construct engaging immersive learning environments. *Experiential Immersive Learning* (EIL) involves activities that allow students to immerse themselves in artificially constructed or virtual worlds that reflect real life situations. For instance, Pagano (2013) illustrates the importance of the experiential in learning CPR skills, where the acquisition of formal knowledge and practice are both of primordial importance. As such, immersive learning is said to fill the often crucial gap between *knowing* and *doing*. Similarly, Johnson and Levine (2008) describe virtual worlds such as ‘Second Life’ and hold that they allow students to become part of a constructed world, interact with the virtual environment, and learn from simulated experiences which are automatically generated based on a specific series of precursory interactions. Interactions in EIL involve a variety of elements including people, activities, quests, tasks, objects and other simulated artifacts and present opportunities that may be difficult to recreate in the real world because of the complexities, costs and risks involved (Inks and Avila 2008; Pagano, 2013).

Via the *Constructivist Learning* method, students are provided with opportunities to learn at their own pace in a customized environment. This learning environment is typically characterized by varying levels of difficulty which take into consideration prior

knowledge and by a capacity to prompt learners to question their unique misconceptions of a subject matter. Constructivism therefore brings reflective and introspective dimensions to immersive learning. In an environment where instructors have the ability to create a personal connection with students, they can engage students in reflective activities via observation and subsequently test them on abstract conceptualizations of a specific subject matter. In other words, acquisition of the knowledge required to partake in activities may be guided or scaffolded. For instance, current technologies allow computers to track the motions and the adopted perspectives of a user and to then update the environment in real-time based on the user's prior movements and behavior Biocca and Delaney (1995).

Finally, *Social or Collaborative Learning* allows students to share and learn from each other. Interactivity plays a crucial role in the world of immersive learning through virtual interactions. Accordingly, Kalay (2004) points out that virtual surroundings can allow for group learning which is similar to physical experiences in the classroom whereby participants are aware of the social process of learning and are affected by the presence and behaviors of peers. Obviously, this form of immersive learning has been greatly facilitated by an ensemble of social media.

Presently, various immersive environments are being effectively used to inculcate a variety of skills in the learners. For instance, immersive learning involves *Virtual Manufacturing* (VM). VM is a computer system with the ability to generate information about the structure, status and behavior of a real manufacturing environment (Mujber, Szecsi, and Hashmi, 2004). This system allows employees to have full access to the entire facility and overview all manufacturing activities. Employees can practice existing

and new tasks in a safe environment, which results in more effective training. They can also explore the outcomes of their decision without the risk of failure and safety issues. Yet another rests with DOME (Schnall, Hedge and Weaver 2012; Sumners 2003; Sumners and Reiff 2004; Sumners, Reiff, and Weber 2008) or Cybersphere (Fernandes, Raja and Eyre, 2003). The Cybersphere was introduced as an immersive hollow translucent sphere which allows unique teaching and training for technicians from the manufacturing sector (Fernandes et al., 2003). This system is also popular in theater training (Sumners, 2003; Sumners and Reiff, 2004) and as an alternative to school field trips. It has also provided civil engineers, real estate agents and travel agents with the capacity to showcase various venues through its projection system.

Most studies of immersive learning and immersive environments have in fact involved gaming technologies. On the other hand, very few studies have investigated classroom computer-assisted immersive activities, which were focused on knowledge acquisition.

A truly immersive learning environment should result in a state of flow (Schaik, Martin and Vallance 2012; see also Csikszentmihalyi 1990; Shernoff & Csikszentmihalyi 2008). Schaik et al. (2012) investigated the experience of *flow* of students as they were immersed in virtual environments. Specifically, they created an immersive environment whose elements were categorized as either person-, artifact- or task-related. Flow was subsequently measured over eight dimensions and found to give rise to highly functional states of performance which were followed by high levels of motivation for continued activity and an impetus for subjects to adopt greater challenges so as to keep experiencing the pleasant state of flow. Similarly, Kefor (2015) provided in his dissertation a

validation of the flow construct in a learning environment. Art students were essentially asked to reflect on and verbalize their flow experiences. Specifically, he found that the degree of autonomy and self-direction afforded to students facilitated flow experiences. Moreover, students reportedly sensed a slowing of time when at their optimal state of engagement. Kefor (2015) also noted the importance of communal sensations where dynamic peer relationships contributed to sustaining flow experiences.

The Immersive Tool

The P2P learning tool is a web-based interactive system that was designed for student learning and assessment. It encourages the active participation of students. The tool is primarily based on the cognitivist approach for analysis, synthesis, evaluation and assessment of a specific subject matter related to pedagogy. The tool also entails elements of constructivism and collaboration facilitated by a three-step process.

In the first phase, the system presents students with a published peer-reviewed article in the area of educational psychology. The students are then required to submit questions through the web-based online system. These questions should be rooted in the article they have read and should be theoretical in nature. The instructor predefines the number of questions for each student. Once these questions are submitted over the online system, the second phase involves asking each student to rate the questions generated by his/her peers with respect to their level of difficulty and level of quality. Thus, if a question is not stated clearly or even has a typing error or is grammatically incorrect, the students may rate it as being of low quality. During this P2P learning process, students are encouraged to provide high quality questions by receiving additional marks in the event their questions are retained for use in subsequent tests.

The scales for both difficulty and quality involve three response options: *Low*, *Moderate* and *High*. The instructor specifies in the system the number of necessary evaluations per question in order to achieve a reasonable level of convergence indicative of consensus. From experience, three evaluations per question may be insufficient because responses can involve three disparate evaluations (for example: one low, one moderate and one high). In fact, we have found that four to five assessments per question were usually adequate. The P2P learning tool includes an algorithm that distributes those questions to different students and ensures that each student does not assess self-generated questions.

Once the entire set of questions has been assessed, the third phase involves the consolidation by the instructor of one or more subsets of questions into multi-item online tests. During the selection process of test questions, the system itself first selects the questions with the highest quality ratings, and then moves down the quality ratings to meet the instructor's test setup requirements.

The resulting test(s) can then be assigned to one (or more) groups of students. Items can be randomized so that each student receives a different testlet with equal proportions of items of low, moderate and high levels of difficulty. It is noteworthy that individual student profiles include gender and ethnic background. Thus, in the third phase, the instructor can create an adapted test by using these criteria and specify from which subset of questions test items are to be selected. For example, items can be selected from subsets generated by male students of a specific ethnic background. The instructor can subsequently also decide which subgroup of students (based on these and/or some other criteria) will take the test.

An interesting proposition that presents itself with this tool is its extension to a game environment where arbitrary and non-arbitrary groupings of students can be put in competitive situations. For instance, students can be randomly or arbitrarily split into groups and put in competition with one another, female students can be put in competition with male students, or students of Asian origin can be put in competition with students of European origin. Such situations can create highly engaging environments by drawing on competitiveness and the minimal group paradigm (Sherif 1966; Tajfel 1970; Tajfel, Billig, Bundy and Flament 1971).

Implementation of the P2P learning tool is based on constructivist as well as cognitivist learning principles. On the one hand, the emphasis the tool puts on student-centered teaching whereby each student is responsible for his or her own construction of knowledge via collaboration with peers is well in line with constructivism (Duffy and Jonassen 1991; Hoy et al. 2013; Merrill 1991). On the other hand, in order to formulate questions and to rate the questions generated by their peers, students should presumably engage in inner mental activities leading to a deeper understanding of the subject matter at hand. This, in turn, reflects the basic tenets of cognitivist learning theories of Ertmer and Newby (1993).

Current Study

The current study ties together a pilot experiment of student knowledge acquisition through the process of a web-based interactive tool (P2P tool) where we defined the environment as an immersive environment. In the following sections, data and results are gathered to understand the performance of students from peer created questions as well as their relative cohort performance through an analysis using Item

Response Theory (IRT). As a first experiment, the analysis allows an overview of student engagement by the type of items generated and their relative performance as a cohort to better understand the level of experience in flow throughout the process.

Methods

Participants and Setting

The interactive peer-to-peer learning and assessment web-based interactive tool (P2P tool) was implemented in a PhD level seminar on pedagogical methods at the John Molson School of Business (Concordia University) in Montreal, Canada. The objectives of this seminar are primarily to teach PhD students to be effective, skillful, thoughtful and confident instructors in any teaching and learning setting, to enable them to design effective courses, and to introduce them to differing perspectives on learning and teaching.

Readings and reference materials draw on seminal work in educational theory and practice. Students learn to provide a conceptual framework to construct and refine pedagogical choices for different audiences. At a theoretical level, learning of the course content (primarily behaviorism, cognitivism and constructivism) revolves on the engagement of students at all four bloom levels. Classes are task-oriented. Tasks emphasize collaboration, reflection, and action. By the end of the semester students are expected to have developed a Teaching Philosophy Statement, Course Outline, taught in a real class setting, and learned about signature pedagogies that have a high educational impact. Importantly, students are asked to reflect on their personality traits, their impact on teaching, and their level of fit to various pedagogical methods. Specifically, the learning goals of the course are to:

- Articulate one's teaching philosophy and a teaching strategy statement;
- Evaluate good teaching practices and the qualities of highly effective teachers in one's area;
- Lead discussions and teach in ways that promote conceptual knowledge and follow effective practice;
- Apply basic instructional design elements to the construction of a course;
- Experience active learning techniques; and
- Enhance communication, presentational and dramaturgical skills as means of connecting with audiences.

The doctoral-level Pedagogy seminar in which the P2P tool was implemented included 15 students. This course is compulsory.

Implementation

Phase 1: Item Generation stage

The 15 participants generated 140 questions in total while perusing at home a published journal article. They were given no time limit but rather a deadline of 7 days. Next, they were asked to create a variety of questions with varying levels of difficulty (easy, medium or hard). This process resulted in *multiple-choice* format.

Phase 2: Peer-Assessment & characteristics of questions generated

Subsequently, each student was asked to assess a subset of 25 questions. Each question was assessed by 2 to 5 students. A scale ranging from '1' (Easy) to '3' (Hard) was used to assess the difficulty level of each question without access to each question's respective answer and a scale ranging from '1' (Low) to '3' (High) was used to rate the quality of each question. An item of high quality was characterized as being

grammatically correct and as displaying a good level of understanding of the information presented in the academic article.

Table 1 indicates that the mean level of perceived quality was 2.05 with a standard deviation of 0.38. Perceived quality ratings ranging from 2.0 to less than 2.5 occurred with a frequency of 55.71%. Table 2 shows that the mean level of perceived difficulty was 1.958 with a standard deviation of 0.41. Difficulty ratings ranging from 2.0 to less than 2.5 occurred with a frequency of 45.71%. These results show there is 73.57% high quality questions generated through this method without too much variance.

Table 1 Levels of quality of generated questions

	Frequency
From 1.0 to less than 1.5	6.43%
From 1.5 to less than 2.0	20.00%
From 2.0 to less than 2.5	55.71%%
From 2.5 to 3.0 (incl)	17.86%
Mean quality	2.05
St.dev.	0.38
Number of questions	140

Table 2 Levels of difficulty of generated questions

	Frequency
From 1.0 to less than 1.5	8.57%
From 1.5 to less than 2.0	30.71%
From 2.0 to less than 2.5	45.71%%
From 2.5 to 3.0 (incl)	15.00%
Mean difficulty	1.958
St.dev.	0.41
Number of questions	140

Phase 3: Generation of Items

Prior to intervention on the part of the instructor, the system is programmed to select an initial subset of items which are deemed minimally acceptable. This preliminary selection is based on pre-established criteria. Thus, 42 questions with four or more ratings and a quality score equal to or greater than 2.25 were selected. This subset represented 30% of the 140 questions in the initial pool.

After the automated subset generation phase, the instructor took into account the difficulty scores within the subset of 42 items. The test generated by the instructor consisted of 18 questions varying in difficulty. Duplicate or overlapping questions were discarded. Table 3 shows the number of questions generated based on varying levels of tolerance which is based on (1) the number of ratings provided and (2) mean quality ratings. The tolerance level allows teachers to select the top quality questions while keeping in mind the availability of the questions created.

Table 3 Level of tolerance and the number of generated questions.

Tolerance level			
Ratings	Quality	Number of Questions Available	%
3+	2+	99	71%
	2.25+	47	34%
	2.5+	23	16%
	2.75+	8	6%
4+	2+	83	59%
	2.25+	42	30%
	2.5+	21	15%
	2.75+	8	6%
5+	2+	15	11%
	2.25+	4	3%
	2.5+	1	1%
	2.75+	1	1%

Table 4 shows the 18 items finally chosen by the instructor. All questions fell within acceptable tolerance levels (i.e., a quality equal to or greater than 2.25 and a total number of ratings of 4 or more) with the exception of Questions 8 and 12. These items were included to ensure adequate proportions of varying levels of difficulties.

Student Performance

Tables 5 and 6 present results on the 18-item test showing the duration and score for each student. Of the 15 registered students, only 9 actually partook in the test taking. This activity was voluntary and was not completed in class but rather online.

It is interesting to note that the duration in time (which was open) ranged from 28 minutes to 98 hours (or 4 days). Since the test was open and the test included questions from one article in educational psychology, results in Table 5 provide insights with respect to how students strategized to complete the test. Those who did the test within one hour or so may have studied the article first (the professor's original intention) and then simply completed the test. On the other hand, it is likely that the students who took more time to complete the test were referring to the article as they answered one question after another. Students who did the test over a duration of days, may have done some questions, kept the screen open then came back to complete other questions at their convenience. It is noteworthy that students who took more time and completed the test progressively did not necessarily obtain a higher score in comparison to students who completed the test in one sitting.

Table 4 Final set of selected questions for the test

	Question	TRatings	Quality	Difficulty
1	What is the strongest moderator in student academic performance?	5	2.8	2.4
2	Which of the following is incorrect about Cohen's d?	4	2.25	2.5
3	Which of the following are correct statements about Western and Eastern education?	4	2.75	2.25
4	What is one of the strongest moderators in students' academic performance?	4	2.5	2.25
5	Which of the following is not one of the 10 constructs examined?	4	2.5	1.75
6	Which of followings is NOT the main objectives in this study?	4	2.75	1.75
7	Which of following variables is not the suggested to investigate in future large-scale international assessment?	4	2.5	2.25
8	Which of following is NOT a cautionary remark for the paper suggested by the author?	4	2	2.5
9	What variable turned out to be less significant than previous research had shown ?	4	3	2
10	The study concludes that learning motivation is	4	2.5	2
11	According to Connor et al (2014), what source influence children's learning?	4	2.75	2.75
12	Which of CLE quality or amount/content/type of instruction students received independently predicted students vocabulary & comprehension gains?	4	2	2.5
13	Why is it possible for a student with high quality teacher not to earn desired outcome in language arts?	4	2.25	2.5
14	What are the sources of influence on learning in the dynamic systems framework used by Connor et al. (2014)	4	2.25	2.75
15	What is the central thesis proposed in Connor et al.'s (2014) article?	4	2.25	2.5
16	Students showed the greatest gains in vocabulary and comprehension when	4	2.5	1.75
17	True or false: Connor et al.'s (2014) study furthers our understanding of which dimensions of the CLE provides better predictors of learning at the individual student level.	4	2.5	1.75
18	According to the authors, which of these variables has received less attention in research and needs further investigation?	4	2.75	1.75

Table 5 Student test results and rankings by test scores

Student	Duration (Min)	Duration (Hrs)	Score
1	72.5	1.208333333	72%
2	244.5	4.075	50%
3	695.3	11.58833333	72%
4	1613.8	26.89666667	67%
5	5471	91.18333333	72%
6	40.7	0.678333333	44%
7	38.4	0.64	83%
8	5888.6	98.14333333	56%
9	42.2	0.703333333	56%

Table 6 Student test results and rankings from shortest to longest duration in time

Student	Duration (Min)	Duration (Hrs)	Score
7	38.4	0.64	83%
6	40.7	0.678333333	44%
9	42.2	0.703333333	56%
1	72.5	1.208333333	72%
2	244.5	4.075	50%
3	695.3	11.58833333	72%
4	1613.8	26.89666667	67%
5	5471	91.18333333	72%
8	5888.6	98.14333333	56%

Data Analysis

Student Performance

The P2P was given as an assignment to students over a span of 7 days, which involved three deadlines. The instructor would usher the group to proceed to a subsequent phase once all students had completed the requirements of the previous phase.

Ph.D.-level seminars typically involve small class sizes, which seldom surpass 15 students. This represents an inherent logistical constraint. In turn, small sample sizes such as those which are for instance endemic to fMRI research and to product and software

usability research are notorious for their low statistical power (Button et al., 2013) and are deemed unsuited to the application of parametric statistical procedures.

To analyze performance we split the 9 students into two categories. Type A (Figure 1 in red) encompasses the students who completed the test within an hour implying that they studied first then immediately completed the test in a single sitting. On the other hand, Type B (Figure 1 in blue) involves the students who progressively answered the questions while referring to the article and who may have completed the test over multiple sittings.

Although 9 cases do not make for a definite conclusion, we do believe the results point towards an interesting phenomenon. In contrasting the two different methods of task completion that are differentiated by duration in time, it appears that those who opted to complete the task progressively did not outperform those who completed the test immediately. This observation alludes to the fact that student's understanding of the article (subject matter) and synthesis of knowledge contained (in the present context) rapidly level off and plateau. Any increase in performance would in fact require intervention on the part of the instructor via mediation of other pedagogical activities.

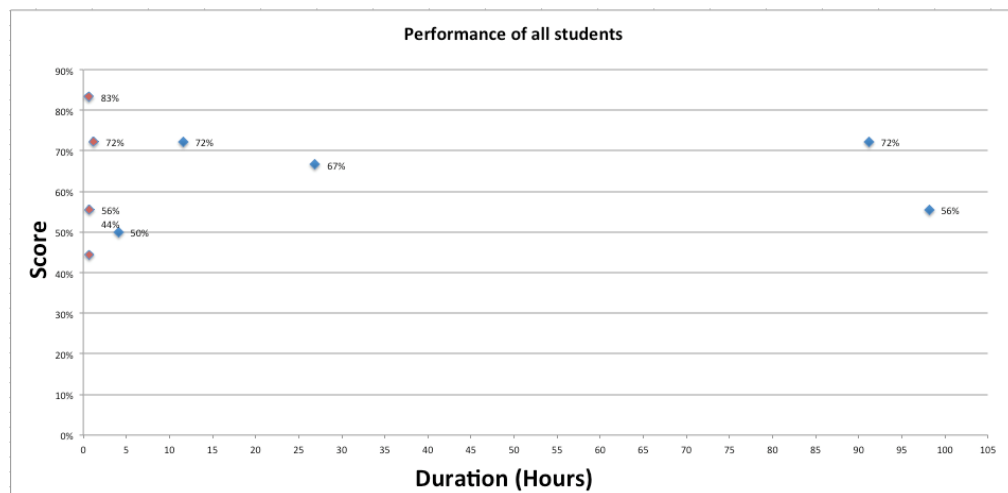

Figure 1 Distribution of test scores given duration in time

Item Response Theory

Due to the context of this study, we identify the item response theory (IRT) as an appropriate method of analysis.

The method of IRT analyzes specifically each question (item) answered by the students, while also looking at their particular total score to assess a student's abilities and proficiency levels. The analysis allows us to look at expected answers providing information for future examinations of the same type. On the other hand, IRT allows a close identification of item by item analysis of each question generated through the P2P tool and the holistic and individual performances of the class. In order to create results, we used Testgraf to generate responses. Testgraf is a software created by Professor Jim Ramsay from McGill University as an aid to the development, evaluation and the use of multiple-choice examinations as well as for psychological scales and questionnaires.

In this sub-section, we present the results in three parts as a preliminary observation of our data obtained through the process of using our P2P Tool as an immersive environment. First, we present student by student analysis while highlighting a sample student's performance through IRT. Second, we investigate item by item results as well as options through IRT. Finally, we bring together a holistic view of our sample of Ph.D student performances and items creations of the test.

Part 1 – Student by Student analysis

Let us show in detail two students for demonstration purposes. Figure 2 shows the analysis of student # 7's performance. The student scored 15/18 (83.33%). The curve in Figure 2 is the relative credibility curve of the student, which illustrates their actual

scores and their expected scores. On the x-axis, there is a vertical straight line, which represents the actual score of the student. On the y-axis is the credibility factor of the student, which means if this student were to retake another exam of the same type, this student's performance would range from 10/18 to 14/18. As the peak of the curve reaches a credibility of 1, it means this student's performance is predicted to be consistent.

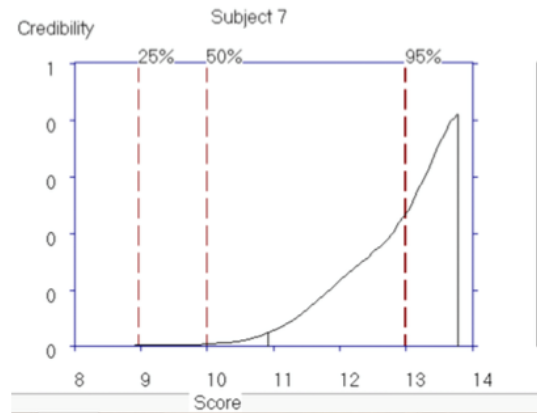

Figure 2. Analysis of student 7.

In comparison, student # 8 (Figure 3) scored 10/18 (70%) ranking them a little lower than 50% of the class (the top percentages represent the percentile rank of the student compared to the entire cohort). This student's expected score ranges from 9 to 13. However, the fluctuation of the curve does not reach a high credibility, this student's performance may fluctuate and show less consistency if they take a similar exam.

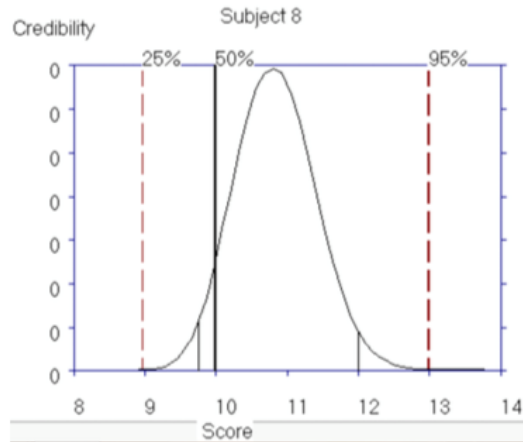

Figure 3. Analysis of student 8.

In **Appendix A**, the red indicator shows students who have taken less time to complete the test which ranges from 38.4 minutes to 72.5 minutes. The blue indicator shows students who have taken a lot more time ranging from 244.5 minutes to 5888.6 minutes to complete the test at home. Overall, although these value may not be significant as students may have left their program open for a large amount of time, we can still categorize these two groups as Type A – students who finished the examination in one sitting (as mentioned above), they studied and did the test and Type B – students who finished the examination in an extended sitting (as mentioned above), they wrote the test while referring to the article.

Inputting the sequential question answers of the students into Testgraf, we are able to generate an analysis per question item, per student and an overview of the test performance. IRT allows test evaluators to check for discrimination within an exam, such that whether a question is differentiating a strong student from the weaker students and whether the questions are balanced in terms of difficulty level.

Part 2 – Item by Item Analysis

Taking a closer look at each item generated, the instructor finalized the test to 18 highest quality and varied difficulty for a sample of 9 Ph.D students. Appendix B shows all 14 items analysis with 4 discarded items when all students answered correctly with no variation in false answers.

We have identified 3 types of items generated which can shed light in the type of engagement student pursued during their creation process. Based on Figure 5, look at an example such as item 3, it has 1 correct answer which has been well performed by high proficiency students, while other students chose a variety of different false answer. This type of question showcases a higher engagement in question creation as the student understood details within their course content and have made their platform efficient. We can also observe, students creating this type of questions have been more creative in their choice of options for their peers. The second type, as an example item 10 shows an inconsistent fluctuation in students 'answers which can reflect ambiguity in the item creation and the creator's own understanding of the course material. Item 10 showcases a type of item that cannot discriminate between low and high proficiency students. Thirdly, item 11 shows only 2 answer choices which provides data that students easily discarded most of the false choice. Item 11 showcases a clear true answer for the high proficiency students while low proficiency students were able to narrow down 5 choices to 2. This can be indicative of a lower involvement in the creator of the item where they have only invested in the effort of 2 options out of 5. Overall, it is interesting to see a variety of items generated by students as the quality in engagement and understanding of the course material is reflective of their cohort's performance. Based on Table 4, it has been shown

that questions with abilities to discriminate between a low and high proficiency student are ranked as higher quality.

Reflecting items 3, 10 and 11 as an example, next to each option graph is the confidence level at 95% of the true position of the curve (in green) which tells us how precisely the curve has been estimated given this number of examinees. Items 3 and 11 show a smaller variation in comparison to item 10 which, due to the uncertainty of choices provoked a large fluctuation. This means each of the items are still not entirely well defined for the students which is the beauty of the learning process using the P2P Tool. As an experiment, this conclusion allows us to refine the learning process through teacher intervention and instructions to ensure a continuous high quality of questions are created by the students. Although at this moment, these results serve as a measure of engagement level from the students.

Part 3 – Overview of the test

The overview of the test analysis allows us to shed light on the cohort's level of knowledge acquisition and the ability for the results of P2P tool to provide an understanding of what makes a discriminant examination that allows differentiation between low and high proficiency students as well as how an exam can be created to allow teacher to retrieve information on the validity of each item.

First, the standard deviation of overall scores within the sample of 9 Ph.D students (Figure 6) shows low to average proficiency students have a standard deviation in score of 1.50 points given 1 point is granted for each of 18 items. At the same time, the standard deviation of the expected score for high proficiency students decreases.

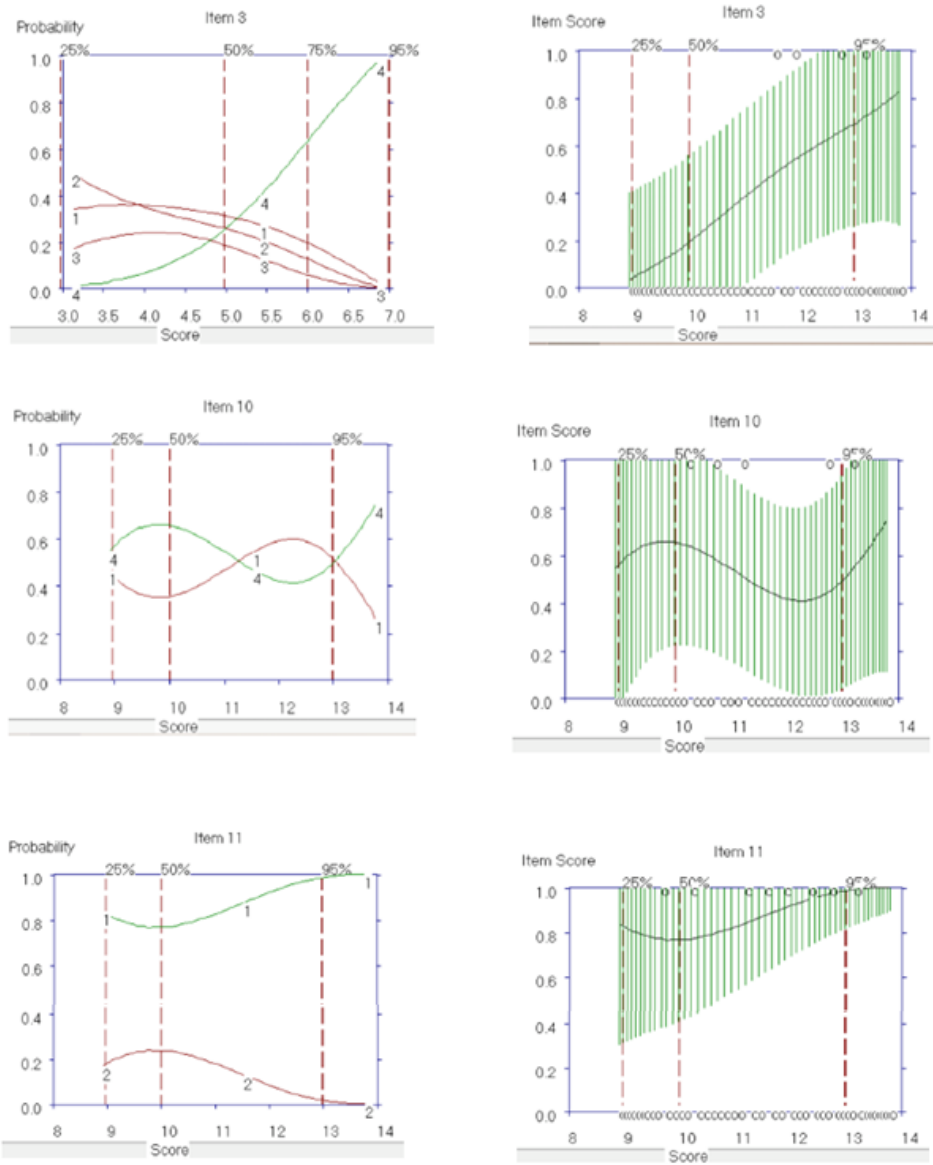

Figure 5. Sample Item and Option curves

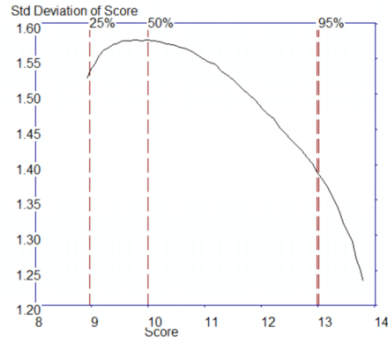

Figure 6. Standard Deviation of Score within Cohort performance

In Figure 7 shows the average item information function which provides an understanding of segments of students whose performance was most informative based on their choice of answers. For example, the test was most informative for students who scored between 10/18 to 13/18 partly due to an amount of easy question which then plateau once harder questions appear. The test information falls off beyond 12/18 due to a lower number of items with highly discriminant features for the high proficiency students hence did not allow the results to showcase different proficiencies within the segment of high performers.

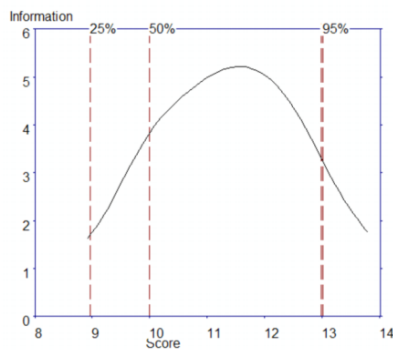

Figure 7. Information Curve

Figure 8 shows an overview of the standard error between right (green line) and wrong (red line) answers. A large fluctuation (variation) exists for students who scored in the 50th to 85th percentile, meaning their wrong answers were not always the same.

While students who scored in the 95th and up or 25th percentile and lower have a lower fluctuation in their scores. In other words, for students who excel or do poorly, their performance is constant with low variations. An efficient score estimate will among other things, weight items according to their quality and make use of information in wrong answer choices. For students ranging from 10 to 13 there is a good estimation of students scores.

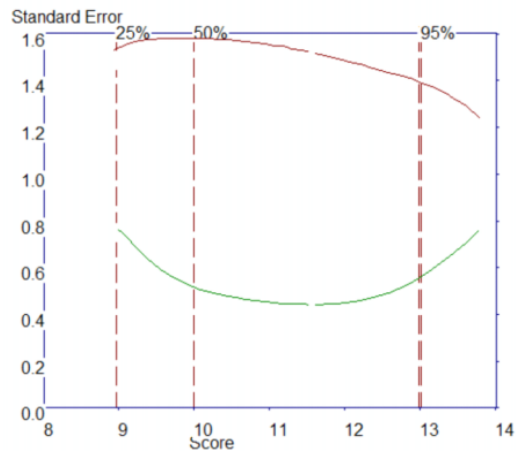

Figure 8. Standard error between right and wrong

The reliability curve (Figure 9) is an indication of the test quality generated by this cohort of students. It is indicative of the consistency in information retrieve from the results of student and whether results are informative to teachers. This curve also assesses the heterogeneity of the population taking the test. In this case, the reliability curve reflect the information curve very well where the segment of students who have shown to be most informative based on their right and wrong answers provides an insight to researchers about their proficiency level.

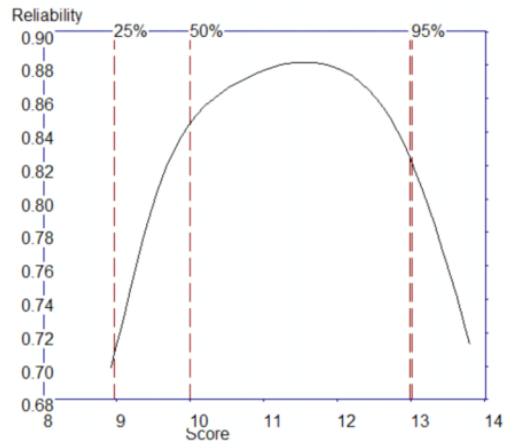

Figure 9. Reliability Curve

Main findings and implications

In today's world stimulated by information technology, the adaptation of IT in learning is relevant to innovation in learning methods. Computer assisted learning open learners and teachers to an era of in –depth student performance analysis that we could not have accessed before. This area of research combines traditional pedagogical philosophies such as Czisentenmihalyi's optimal flow state in performance immersion and creativity, Benjamin Bloom's taxonomy of learning, Ikujiro Nonaka & Hirotaka Takeuchi's knowledge creation model and the 20th's century data oriented and technology assisted world of learning.

Our main findings attempt to verify and justify the relevance of a new way of learning which involves Experiential Immersive Learning (EIL) where students live through the process of experiential, constructivist and collaborative learning in one activity.

Students are switching roles from test takers to test creators, a scenario that conducts engagement and interest in students. We found that students had the ability to

generate a spectrum of questions that varied by difficulty level, where 71% of the questions generated can be used in an examination. Based on our analysis, students plateau in their performance which shows that an immersive learning platform needs an intervention by the professor to move learning forward but this also shows the peer to peer method allows students to adapt different learning methods that fits them. In this case, students can choose to study then take a test, or refer and study while attempting the test. Our results do not show large discrepancies, which advocates for this method to have constructivist advantages that traditional learning methods do not offer.

Our computer assisted platform allows students to collaborate by providing feedback on the level of difficulty and the quality level of questions generated, which referring to Kefor (2015) creates a peer learning environment where communal sensations help sustain the flow experiences. In addition Our computer assisted system has the ability to filter, distribution questions at the ease and preferences of the professor in charge whereby helping the professor to focus on pedagogy.

Finally, our IRT analysis allows researchers, professors and learners to see their performances in comparison to their respective cohort, their predicted performances and their potential consistencies. These measures allows immediate feedback and understanding of a class of 10 or 500 at the tip of the professor's fingers when automated.

Future Research

Throughout the literature, immersive learning showcases many advantages to improve current learning, not only do virtual realities allow possibilities of visualizing environment that a human cannot see in real life, virtual realities creates an interactive nature which allows knowledge to be spread quickly, effectively and globally. Through

the four dimensions of the teaching process (context setting, class preparation, class delivery and continuous improvement) and the three styles of learning (Experiential, Constructivist, Collaborative), these elements all contribute into the use of virtual realities as tools to utilize immersive learning as an upcoming, important learning style. In this proposal, as the literature on immersive learning is still at its beginning, many perspectives can be explored as we suggest further investigation into the use of human senses such as tactile, olfactory, auditory, visual and gustatory as an integration to creating immersive learning styles.

At the moment, virtual realities only touch on tactile, auditory and visual senses, however, based on branding literature and psychology research of senses, olfactory is one of the most powerful senses in creating memories (Anggie & Haryanto, 2011) at the conscious and unconscious level. The olfactory sense combined with all four senses creates an experience for students to immerse into a learning environment. In addition, gustatory sense compliments all other senses as the smell influences the taste perception (Krishna et al., 2014), which in turn influences the perception of an object, an environment and a product. To support this proposition, Sumners, Reiff and Weber (2008) have shown the relevance of using more modalities in learning styles, do make the process more effective.

While Nokia has presented a multi-sensory communications devices (Hultén, 2011), similar branding strategies can be created towards education as the cognitive, behavioral processes are the same in gaining attention, creating retention. The popularity and necessity of virtual realities will become the default method for representing problems (Jonassen, 1999). This invention, with multiple assets such as having a

collaborative, interactive nature can be enhanced to multiple modalities, multi-sensory learning styles. This platform also adds freedom and decision making potential (Darvasi 2008), representation of both abstract and concepts material, while allowing individuals to have a presence (Dickey 2003) in a world they could have never imagined existed in a cost effective, high quality and motivating environment.

In the present study, we aimed at creating an innovative pedagogical method that utilizes IT and the web to help engage students in different ways. The resulting P2P learning tool design process can be linked to the constructivist and cognitivist approaches and provides a wide range of learning opportunities by changing the configuration setup. Through these combinations, the tool allows students to be immersed in the activity of capturing and synthesizing relevant information.

We presented herein a pilot study using the P2P learning tool and executed in a PhD class. The results were interesting as they revealed a number of insights namely:

- That students engaged with each other (~constructivism)
- That students engaged with subject matter (~cognitivism)
- That spending more time on a test is not a guarantee to perform better
- The P2P learning tool
 - can be very effective
 - has an immersive learning element in its design and process
 - can be utilized for learning and assessment at the same time

Appendix A **Figure 4** Nine Students predicted performance and score.

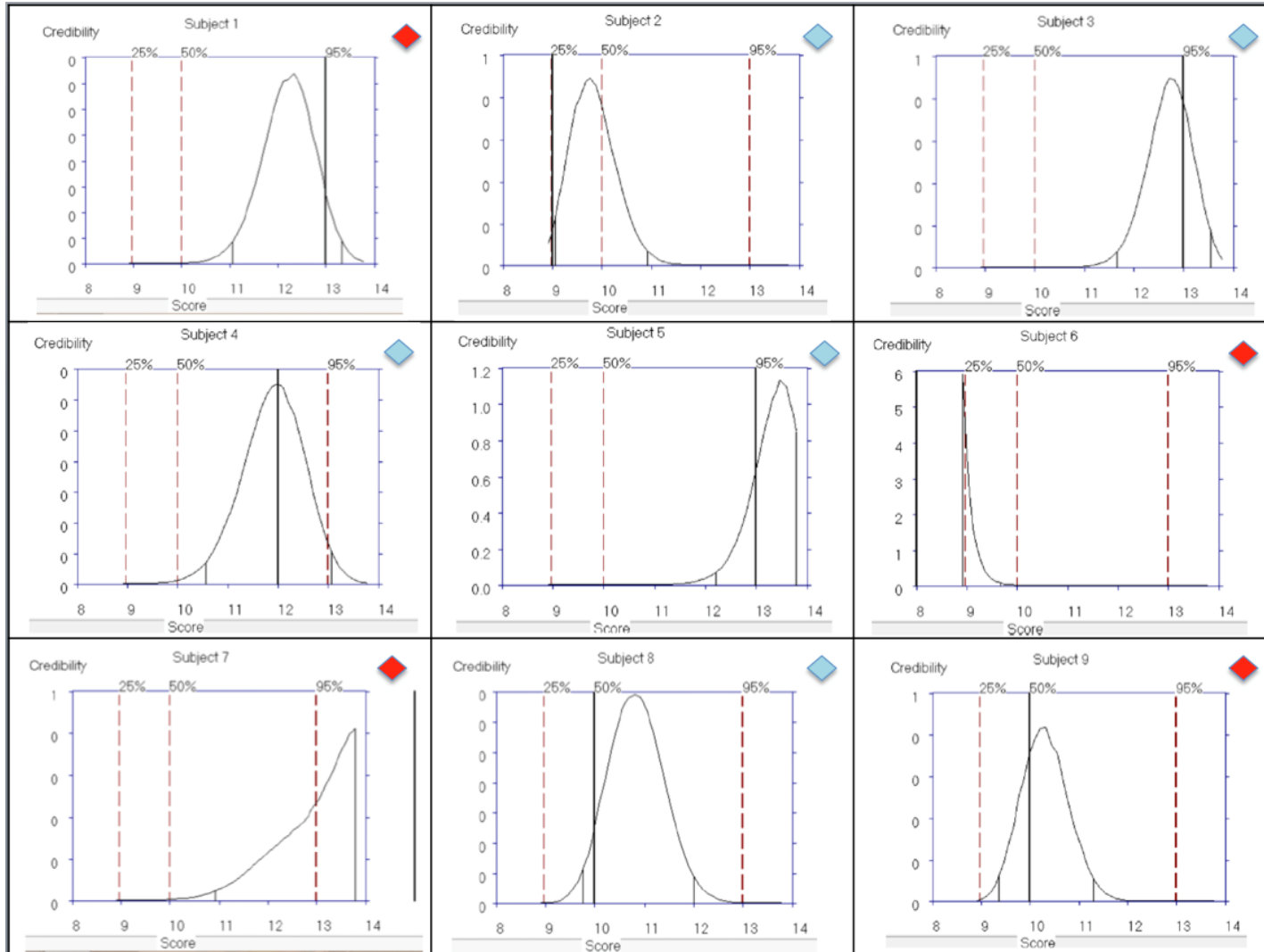

Appendix B Summary of all items in the test

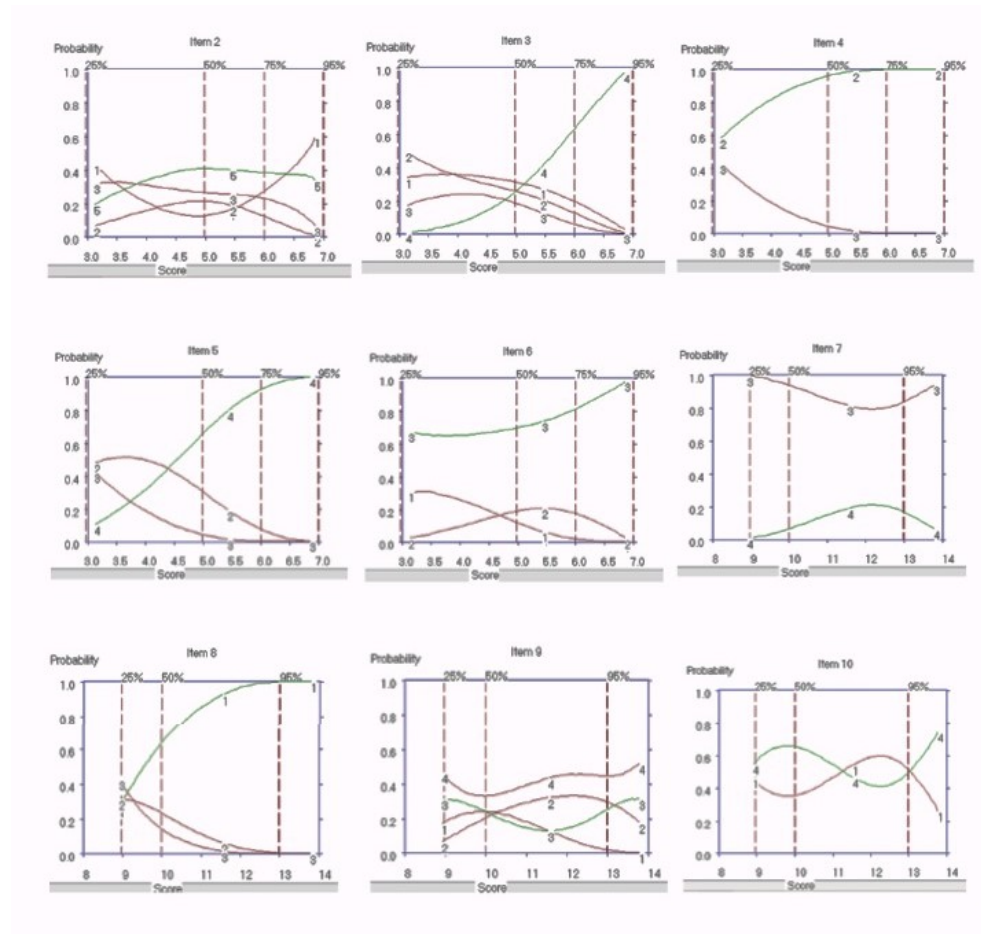

References

- Ahmed, A., & Sutton, M. J. D. (2017). Gamification, serious games, simulations, and immersive learning environments in knowledge management initiatives. *World Journal of Science, Technology and Sustainable Development*, 14(2/3), 78–83.
- Al-Bataineh, A., Anderson, S., Toledo, C., & Wellinski, S. (2008). A Study of Technology Integration in the Classroom. *International Journal of Instructional Media*, 35(4), 381–387. Retrieved from <http://proxy1.ncu.edu/login?url=http://search.ebscohost.com/login.aspx?direct=true&db=ofs&AN=50803776&site=ehost-live%5Chttp://content.ebscohost.com.proxy1.ncu.edu/ContentServer.asp?T=P&P=AN&K=508037766&S=R&D=ofs&EbscoContent=dGJyMNHX8kSeprE4y9f3OLCmr0y>
- Algarawi, F. K., Alslamah, W. A., Alhabib, A. A., Alfahaid, A. S., & Ibrahim, D. M. (2018). Applying Augmented Reality Technology for E-Learning System. *World Academy of Science, Engineering and Technology International Journal of Computer and Information Engineering International Science Index, Computer and Information Engineering International Scholarly and Scientific Research & Innovation*, 1212(123). Retrieved from <https://waset.org/pdf/books/?id=81543&pageNumber=1>
- Almekhlafi, A. G., & Almeqdadi, F. A. (2010). Teachers' perceptions of technology integration in the United Arab Emirates school classrooms. *Journal of Educational Technology & Society*, 13(1), 165.
- Amsel, A. (1962). FRUSTRATIVE NONREWARD IN PARTIAL REINFORCEMENT AND DISCRIMINATION LEARNING: SOME RECENT HISTORY AND A THEORETICAL EXTENSION. *Psychological Review*, 69(4), 306–328. Retrieved from <http://0-psychnet.apa.org.mercury.concordia.ca/fulltext/1964-02017-001.pdf?sr=1>
- Andena, S., Norton, B., & Kendrick, M. (2010). ICT, cultural knowledge, and teacher education in Africa.
- Anderson, R. C., Spiro, R. J., & Montague, W. E. (2017). *SCHOOLING AND THE ACQUISITION OF KNOWLEDGE*. (Routledge, Ed.). ROUTLEDGE. Retrieved from [https://books.google.ca/books?id=fmE1DwAAQBAJ&dq=Anderson,+R.+C.,+Spiro,+R.+J.,+%26+Montague,+W.+E.+\(Eds.\).+2017&lr=&source=gbs_navlinks_s](https://books.google.ca/books?id=fmE1DwAAQBAJ&dq=Anderson,+R.+C.,+Spiro,+R.+J.,+%26+Montague,+W.+E.+(Eds.).+2017&lr=&source=gbs_navlinks_s)
- Anggie, C., & Haryanto, J. O. (2011). Analysis of the effect of olfactory, approach behavior, and experiential marketing toward purchase intention. *Gadjah Mada International Journal of Business*, 13, 85–101.
- Angus*, L., Snyder, I., & Sutherland-Smith, W. (2004). ICT and educational (dis) advantage: families, computers and contemporary social and educational inequalities. *British Journal of Sociology of Education*, 25(1), 3–18.
- Angus, L., Snyder, I., & Sutherland-Smith, W. (2004). ICT and educational (dis) advantage : families , computers and contemporary social and educational inequalities. *British Journal of Sociology of*

Education, 25(1), 3–18. <http://doi.org/10.2307/4128656>

- Arbabi, A. O., Davidekova, M., Hvorecký, J., Henderson, M., Selwyn, N., Aston, R., ... Xiang, J. (2017). The Role of Social Media in Knowledge Management: How SECI-SM Model Can Help. *International Journal of Innovative Research and Development* | ISSN 2278–0211, 42(1), 480–485. Retrieved from http://centaur.reading.ac.uk/70274/1/PDF_Proof.PDF
- Arling, P. A., & Chun, M. W. S. (2011). Facilitating new knowledge creation and obtaining KM maturity. *Journal of Knowledge Management*, 15(2), 231–250.
- Auster, E. R., & Wylie, K. K. (2006). Creating active learning in the classroom: A systematic approach. *Journal of Management Education*, 30(2), 333–353.
- Bagozzi, R. P., Davis, F. D., & Warshaw, P. R. (1992). Development and test of a theory of technological learning and usage. *Human Relations*, 45(7), 659–686.
- Barto, A. G. (2013). Intrinsic motivation and reinforcement learning. In *Intrinsically motivated learning in natural and artificial systems* (pp. 17–47). Springer.
- Bernier, R., & Bowen, J. P. (2004). Web-based discussion groups at stake: The profile of museum professionals online. *Program*, 38(2), 120–137.
- Biocca, F., & Delaney, B. (1995). Immersive virtual reality technology. *Communication in the Age of Virtual Reality*, 57–124.
- Bloom, B. (1956). *Taxonomy of learning objectives: The classification of educational goals*. New York: D. McKay Publishing.
- Bobbitt, L. M., Inks, S. A., Kemp, K. J., & Mayo, D. T. (2000). Integrating Marketing Courses to Enhance Team-Based Experiential Learning. *Journal of Marketing Education*. <http://doi.org/10.1177/0273475300221003>
- Bolisani, E., & Bratianu, C. (2018). Strategic Performance and Knowledge Measurement (pp. 175–198). Springer, Cham. http://doi.org/10.1007/978-3-319-60657-6_8
- Burbules, N., & Callister, T. (2000). Universities in transition: The promise and the challenge of new technologies. *The Teachers College Record*, 102(2), 271–293. <http://doi.org/10.1111/0161-4681.00056>
- Carmean, C., & Haefner, J. (2003). Next-generation course management systems. *Educause Quarterly*, 26(1), 10–13.
- Chai, C. S., Hong, H.-Y., & Teo, T. (2009). Singaporean and Taiwanese Pre-service Teachers' Beliefs and their Attitude Towards ICT Use: A Comparative Study. *The Asia-Pacific Education Researcher*, 18(1), 865–869. <http://doi.org/10.3860/taper.v18i1.1040>
- Chang, H. H., & Wang, I. C. (2008). An investigation of user communication behavior in computer

- mediated environments. *Computers in Human Behavior*, 24(5), 2336–2356.
- Chaves, M. S., Scornavacca, E., & Fowler, D. (2018). Affordances of Social Media in Knowledge Sharing in Intra-Organizational Information Technology Projects. *In Digital Technology and Organizational Change*, 35–47.
- Choy, D., Wong, A. F. L., & Gao, P. (2009). Student teachers' intentions and actions on integrating technology into their classrooms during student teaching: A singapore study. *Journal of Research on Technology in Education*, 42(2), 175–195. <http://doi.org/10.1080/15391523.2009.10782546>
- Christopoulos, A., Conrad, M., & Shukla, M. (2018). Increasing student engagement through virtual interactions: How? *Virtual Reality*, 1–17. <http://doi.org/10.1007/s10055-017-0330-3>
- Chung, J., & Tan, F. B. (2003). Antecedents of Perceived Playfulness: An Exploratory Study on User Acceptance of General Information-searching Websites. Retrieved from http://aut.researchgateway.ac.nz/bitstream/handle/10292/1068/Antecedents_playfulness.pdf?sequence=1&isAllowed=y
- Comber, B., & Green, B. (1999). Information Technology, Literacy and Educational Disadvantage Research and Development: Project Report to DETE SA, Vol. 1. *More than Just Literacy? A Situated Research Study of Information Technology, Literacy Pedagogy and Educational Disadvantage, with Specific Reference to Six South Australian Public Schools*.
- Cook, S. D. N., & Brown, J. S. (1999). Bridging epistemologies: The generative dance between organizational knowledge and organizational knowing. *Organization Science*, 10(4), 381–400.
- Cross, K. P. (1976). *Accent on Learning. Improving Instruction and Reshaping the Curriculum*.
- Csikszentmihalyi, M. (1975). Play and intrinsic rewards. *Journal of Humanistic Psychology*.
- Csikszentmihalyi, M. (1990). *Flow: The psychology of optimal performance*. NY: Cambridge University Press, 40.
- Csikszentmihalyi, M., & Csikszentmihalyi, I. S. (1992). *Optimal experience: Psychological studies of flow in consciousness*. Cambridge university press.
- Davis, F. D. (1989). Perceived usefulness, perceived ease of use, and user acceptance of information technology. *MIS Quarterly*, 319–340.
- Davis, F. D., Bagozzi, R. P., & Warshaw, P. R. (1992). Extrinsic and intrinsic motivation to use computers in the workplace. *Journal of Applied Social Psychology*, 22(14), 1111–1132.
- Davis, S., & Wiedenbeck, S. (2001). The mediating effects of intrinsic motivation, ease of use and usefulness perceptions on performance in first-time and subsequent computer users. *Interacting with Computers*, 13(5), 549–580.
- Dearman, J. K. (2015). Increasing college students' experience of flow while completing academic writing

tasks.

- Doering, A., Hughes, J., & Huffman, D. (2003). Preservice teachers: Are we thinking with technology? *Journal of Research on Technology in Education*, 35(3), 342–361.
<http://doi.org/10.1080/15391523.2003.10782390>
- Doménech-Betoret, F., Abellán-Roselló, L., & Gómez-Artiga, A. (2017). Self-Efficacy, Satisfaction, and Academic Achievement: The Mediator Role of Students' Expectancy-Value Beliefs. *Frontiers in Psychology*, 8, 1193. <http://doi.org/10.3389/fpsyg.2017.01193>
- Economist. (2008). The Future of Higher Education: How Technology Will Shape Learning. *Economist Intelligence Unit*, 1–31. <http://doi.org/10.1111/bjet.12049>
- Ertmer, P. A., & Ottenbreit-Leftwich, A. T. (2010). Teacher technology change: How knowledge, confidence, beliefs, and culture intersect. *Journal of Research on Technology in Education*, 42(3), 255–284. <http://doi.org/10.1080/15391523.2010.10782551>
- Esteban-Millat, I., Martínez-López, F. J., Huertas-García, R., Meseguer, A., & Rodríguez-Ardura, I. (2014). Modelling students' flow experiences in an online learning environment. *Computers & Education*, 71, 111–123.
- Facer, K., Furlong, J., & Furlong, R. (2010). Constructing the child computer user: From public policy to private practices. *British Journal of Sociology of Education*, 22(1), 91–108.
<http://doi.org/10.1080/0142569002003080>
- Fagerholm, H., & Helelä, M. (2003). *Handbook for Transforming a BBA Program in International Business Into a Problem-based Learning Curriculum: Case: Liibba Program at Helia*. Helsinki Business Polytechnic.
- Fernandes, K. J., Raja, V. H., & Eyre, J. (2003). Immersive learning system for manufacturing industries. *Computers in Industry*, 51(1), 31–40.
- Finneran, C. M., & Zhang, P. (2003). A person–artefact–task (PAT) model of flow antecedents in computer-mediated environments ARTICLE IN PRESS. *Int. J. Human-Computer Studies*, 59, 475–496. [http://doi.org/10.1016/S1071-5819\(03\)00112-5](http://doi.org/10.1016/S1071-5819(03)00112-5)
- Foote, A., & Halawi, L. A. (2018). Knowledge Management Models within Information Technology Projects. *Journal of Computer Information Systems*, 58(1), 89–97.
- Frederick, G. R., Schweizer, H., & Lowe, R. (2006). After the in-service course challenges of technology integration. *Computers in the Schools*, 23(1–2), 73–84. http://doi.org/10.1300/J025v23n01_07
- Fu, J. S. (2013). ICT in Education: A Critical Literature Review and Its Implications. *International Journal of Education and Development Using Information and Communication Technology*, 9(1), 112–125.
<http://doi.org/http://ijedict.dec.uwi.edu/viewarticle.php?id=1541>

- Furneaux, C. W. (2004). How does Information Technology impact the methods, potential and purpose of education? *ETL Conference, 2004, Logan Campus, Griffith University*, (2000). Retrieved from <http://eprints.qut.edu.au/794/>
- Glenn, M., & D'Agostino, D. (2008). The future of higher education: How technology will shape learning. *New Media Consortium*.
- Goktas, Y., Yildirim, S., & Yildirim, Z. (2009). Main barriers and possible enablers of ICTs Integration into pre-service teacher education programs. *Educational Technology and Society*, 12(1), 193–204. <http://doi.org/Article>
- Gottlieb, J., Hayhoe, M., Hikosaka, O., & Rangel, A. (2014). Symposium Attention, Reward, and Information Seeking. *The Journal of Neuroscience*, 34(46), 15497–15504. <http://doi.org/10.1523/JNEUROSCI.3270-14.2014>
- Gourlay, S. (2006). Conceptualizing knowledge creation: a critique of Nonaka's theory. *Journal of Management Studies*, 43(7), 1415–1436.
- Grant, R. M., & Baden-Fuller, C. (2000). Knowledge and economic organization: an application to the analysis of interfirm collaboration. In *Knowledge Creation* (pp. 113–150). Springer.
- Hardaker, G., & Smith, D. (2002). E-learning communities, virtual markets and knowledge creation. *European Business Review*, 14(5), 342–350.
- Harsh, O. K. (2009). Three dimensional knowledge management and explicit knowledge reuse. *Journal of Knowledge Management Practice*, 10(2), 1–10.
- Hassenzahl, M., Platz, A., Burmester, M., & Lehner, K. (2000). Hedonic and ergonomic quality aspects determine a software's appeal. In *Proceedings of the SIGCHI conference on Human Factors in Computing Systems* (pp. 201–208). ACM.
- Heisig, P. (2009). Harmonisation of knowledge management—comparing 160 KM frameworks around the globe. *Journal of Knowledge Management*, 13(4), 4–31.
- Henderson, M., Selwyn, N., & Aston, R. (2017). What works and why? Student perceptions of “useful” digital technology in university teaching and learning. *Studies in Higher Education*, 42(8), 1567–1579.
- Her, P. (2017). *Students' Perceptions on Adoption of Desktop Virtualization in Higher Education Environment: A Multiple Case Study*. Retrieved from <https://search.proquest.com/openview/8a0410c763dd2cbd90d3ce74a1e46094/1?pq-origsite=gscholar&cbl=18750&diss=y>
- Herrera, F., Guerrero, M., & Urbano, D. (2018). Entrepreneurship and Innovation Ecosystem's Drivers: The Role of Higher Education Organizations (pp. 109–128). Springer, Cham. http://doi.org/10.1007/978-3-319-71014-3_6

- Higgins, S., Xiao, Z., & Katsipataki, M. (2012). The impact of digital technology on learning: A summary for the education endowment foundation. *Durham, UK: Education Endowment Foundation and Durham University.*
- Hjørland, B. (2008). Information literacy and digital literacy. *Prisma. Com, (7), 4–15.*
- Ho, A. G. (2017). Enriching the User Experience in Social Messaging: Emotion in Communication Design. *Online Journal of Art and Design, 5(1)*. Retrieved from <http://www.adjournal.net/articles/51/515.pdf>
- Honan, E. (2008). Barriers to teachers using digital texts in literacy classrooms. *Literacy, 42(1), 36–43.*
<http://doi.org/10.1111/j.1467-9345.2008.00480.x>
- Huang, M. H. (2003). Designing website attributes to induce experiential encounters. *Computers in Human Behavior, 19(4), 425–442.* [http://doi.org/10.1016/S0747-5632\(02\)00080-8](http://doi.org/10.1016/S0747-5632(02)00080-8)
- Hultén, B. (2011). Sensory marketing: the multi-sensory brand-experience concept. *European Business Review, 23(3), 256–273.* <http://doi.org/10.1108/09555341111130245>
- Hutchison, A., & Reinking, D. (2011). Teachers' perceptions of integrating information and communication technologies into literacy instruction: A national survey in the United States. *Reading Research Quarterly.* <http://doi.org/10.1002/RRQ.002>
- Inal, Y., & Cagiltay, K. (2007). Flow experiences of children in an interactive social game environment. *British Journal of Educational Technology, 38(3), 455–464.*
- Inks, S. A., & Avila, R. A. (2008). Preparing the next generation of sales professionals through social, experiential, and immersive learning experiences. *Journal for Advancement of Marketing Education, 13(4), 47–55.*
- Jackson, S. A., & Marsh, H. W. (1996). Development and Validation of a Scale to Measure Optimal Experience: The Flow State Scale. *JOURNAL OF SPORT & EXERCISE PSYCHOLOGY, 18, 17–35.*
Retrieved from <http://fitnessforlife.org/AcuCustom/Sitename/Documents/DocumentItem/8983.pdf>
- Jakubik, M. (2008). Experiencing collaborative knowledge creation processes. *The Learning Organization, 15(1), 5–25.*
- Jakubik, M. (2011). Becoming to know. Shifting the knowledge creation paradigm. *Journal of Knowledge Management, 15(3), 374–402.*
- Johnson, L. F., & Levine, A. H. (2008). Virtual worlds: Inherently immersive, highly social learning spaces. *Theory Into Practice, 47(2), 161–170.*
- Jonassen, D. (1999). Designing constructivist learning environments. In *Instructional-Design Theories and Models* (Vol. 2, pp. 215–239).
- Kalay, Y. E. (2004). Virtual learning environments. *Journal of Information Technology in Construction (ITcon), 9, 195–207.*

- Kassim, M. H., Abdullah, F., Denan, Z., & Arafat, K. A. (2017). Physical versus Augmented Reality Model: Comparative Study Toward Learning Experiences at Heritage Studies Gallery. *Advanced Science Letters*, 23(2), 890–893.
- Kefor, T. (2015). *Arts students in flow: An interpretative phenomenological analysis*. Northeastern University.
- Kersh, B. Y. (1962). The motivating effect of learning by directed discovery. *Journal of Educational Psychology*, 53(2), 65.
- Kidd, C., & Hayden, B. Y. (2015). The psychology and neuroscience of curiosity. *Neuron*, 88(3), 449–460.
- Kiili, K. (2005). Content creation challenges and flow experience in educational games: The IT-Emperor case. *The Internet and Higher Education*, 8(3), 183–198.
- Klebba, J. M., & Hamilton, J. G. (2007). Structured Case Analysis: Developing Critical Thinking Skills in a Marketing Case Course. *Journal of Marketing Education*.
<http://doi.org/10.1177/0273475307302015>
- Koufaris, M. (2002). Applying the technology acceptance model and flow theory to online consumer behavior. *Information Systems Research*, 13(2), 205–223.
- Krishna, A., Morrin, M., & Sayin, E. (2014). Smellizing Cookies and Salivating: A Focus on Olfactory Imagery. *Journal of Consumer Research*, 41(1), 18–34. <http://doi.org/10.1086/674664>
- Kristensen, T. (1999). The "Reidar" Project. In *Proceedings of The Sixteenth International Conference on Technology and Education*. Edinburgh, UK.
- Lavie, T., & Tractinsky, N. (2004). Assessing dimensions of perceived visual aesthetics of web sites. *International Journal of Human-Computer Studies*, 60(3), 269–298.
- Leong, P. (2011). Role of social presence and cognitive absorption in online learning environments. *Distance Education*, 32(1), 5–28.
- Li, H., Lai, V., & Luo, X. (2016). Understanding the role of social situations on continuance participation intention in online communities: An empirical perspective. *Journal of Electronic Commerce Research*, 17(4), 358–380.
- Lim, C. P. (2007). Effective integration of ICT in Singapore schools: Pedagogical and policy implications. *Educational Technology Research and Development*, 55(1), 83–116. <http://doi.org/10.1007/s11423-006-9025-2>
- Lin, C. S., Wu, S., & Tsai, R. J. (2005). Integrating perceived playfulness into expectation-confirmation model for web portal context. *Information & Management*, 42(5), 683–693.
- Liu, Y., & Szabo, Z. (2009). Teachers' attitudes toward technology integration in schools: A four-year study. *Teachers and Teaching: Theory and Practice*, 15(1), 5–23.

<http://doi.org/10.1080/13540600802661295>

- Ludvigsen, S., & Arnseth, H. C. (2017). Computer-supported collaborative learning. In *Technology enhanced learning* (pp. 47–58). Springer.
- Macfarlane, A., & Robson, M. (2017). An interactive model for delivery of a distance learning LLM programme using the eXe learning tool-our journey.
- Martocchio, J. J. (1994). Effects of conceptions of ability on anxiety, self-efficacy, and learning in training. *Journal of Applied Psychology, 79*(6), 819.
- Maslowski, R. (2001). *School Culture and School Performance. Culture*. Retrieved from <https://research.utwente.nl/en/publications/school-culture-and-school-performance-an-explorative-study-into-t>
- Meyer, K. A., & Jones, S. J. (2013). Do Students Experience Flow Conditions Online?. *Journal of Asynchronous Learning Networks, 17*(3), 137–148.
- Meyers, E. M., Erickson, I., & Small, R. V. (2013). Digital literacy and informal learning environments: an introduction. *Learning, Media and Technology, 38*(4), 355–367.
- Milgram, P., Takemura, H., Ustimi, A., & Kishino, F. (1994). Augmented Reality: A class of display on the reality-virtuality continuum. *Telemanipulator and Telepresence Technologies, 2351*, 282–292.
- Moen, Ø., Benum, J. D., & Gjørsum, I. (2018). Exploring Informal and Formal Learning Activities as Enablers of Learning-by-Exporting in Small and Medium Sized Firms. *Advances in Global Marketing, 127*–146.
- Moon, J.-W., & Kim, Y.-G. (2001). Extending the TAM for a World-Wide-Web context. *Information & Management, 38*(4), 217–230.
- Mostafa, A. (2018). Mediating Experiential Learning in Interactive Immersive Environments.
- Mukherjee, A., & Bleakney, S. (2017). Redesigning an Introduction to Information Systems Course for Scalable Active Learning in Online and Blended Environments.
- Newman, F., & Scurry, J. E. (2015). Higher education and the digital Rapids. *International Higher Education, (26)*.
- Nguyen, L., Barton, S. M., & Nguyen, L. T. (2015). iPads in higher education—Hype and hope. *British Journal of Educational Technology, 46*(1), 190–203.
- Niederman, F., & Rollier, B. (2001). How are you going to keep them in the classroom after they've seen MTV? Online education in a virtual world. In *Our Virtual World: The Transformation of Work, Play and Life via Technology* (pp. 56–73). IGI Global.
- Nonaka, Ikujiro, Takeuchi, H., & Umemoto, K. (1996). A theory of organizational knowledge creation. *International Journal of Technology Management, 11*(7–8), 833–845.

- Nonaka, I., Toyama, R., & Hirata, T. (2008). *Managing flow: A process theory of the knowledge-based firm*. Springer.
- Nonaka, I., Toyama, R., & Konno, N. (2000). SECI, Ba and leadership: a unified model of dynamic knowledge creation. *Long Range Planning*, 33(1), 5–34.
- North, M. M. (2014). Distance learning immersive environments: Sense of presence exploration. *Journal of Visual Languages & Computing*. <http://doi.org/10.1016/j.jvlc.2014.09.006>
- Oudeyer, P.-Y., Kaplan, F., & Hafner, V. V. (2007). Intrinsic motivation systems for autonomous mental development. *IEEE Transactions on Evolutionary Computation*, 11(2), 265–286.
- Pearce, J. M., Ainley, M., & Howard, S. (2005). The ebb and flow of online learning. *Computers in Human Behavior*, 21(5), 745–771.
- Pena-Rios, A., Callaghan, V., & Gardner, M. (2018). Multi-User Mixed Reality Environments for Distance Learning. In *Integrating Multi-User Virtual Environments in Modern Classrooms* (pp. 208–237). UK. Retrieved from https://books.google.ca/books?hl=en&lr=&id=gpBFDwAAQBAJ&oi=fnd&pg=PA208&dq=Peña-Rios,+A.,+Callaghan,+V.,+%26+Gardner,+M.+2018&ots=q7gdJ2Gwi2&sig=Im90KnZWbrhd7Z3yUHewTqBWGGQ&redir_esc=y#v=onepage&q&f=false
- Pirker, J., Kultima, A., & Gütl, C. (2016). The value of game prototyping projects for students and industry. In *Proceedings of the International Conference on Game Jams, Hackathons, and Game Creation Events* (pp. 54–57). ACM.
- Quintana, M. G. B., & Aranguiz, M. S. B. (2018). Use of ICT to innovate teaching and learning processes in higher education. In *Enhancing Knowledge Discovery and Innovation in the Digital Era - Google Books* (p. 36). Chile. Retrieved from https://books.google.ca/books?hl=en&lr=&id=hpBFDwAAQBAJ&oi=fnd&pg=PA36&dq=Quintana,+M.+G.+B.,+%26+Aranguiz,+M.+S.+B.+2018&ots=5VQjaT-qO3&sig=UieRSrkiYxwcCfp4k4kDoZPMM3g&redir_esc=y#v=onepage&q&f=false
- Randall, A., & Ruddell, S. (1946). Adult Literacy. *Journal of Adolescent & Adult Literacy*.
- Reddy, R., & PS Goodman. (2002). Technology trends and implications for learning in tertiary institutions. *Books.google.com*. Retrieved from [https://books.google.ca/books?hl=en&lr=&id=DcSQAqAAQBAJ&oi=fnd&pg=PA3&dq=Technology+Trends+and+Implications+for+Learning+in+Tertiary+Institutions.+In+P.S.+Goodman+\(Ed.\)+&ots=25oxSP7PsS&sig=nOEOpecAMglboeUaASVdWuHDQwM](https://books.google.ca/books?hl=en&lr=&id=DcSQAqAAQBAJ&oi=fnd&pg=PA3&dq=Technology+Trends+and+Implications+for+Learning+in+Tertiary+Institutions.+In+P.S.+Goodman+(Ed.)+&ots=25oxSP7PsS&sig=nOEOpecAMglboeUaASVdWuHDQwM)
- Rodríguez-Ardura, I., & Meseguer-Artola, A. (2017). Flow in e-learning: What drives it and why it matters. *British Journal of Educational Technology*, 48(4), 899–915. <http://doi.org/10.1111/bjet.12480>
- Rossin, D., Ro, Y. K., Klein, B. D., & Guo, Y. M. (2009). The effects of flow on learning outcomes in an

- online information management course. *Journal of Information Systems Education*, 20(1), 87.
- Roy, A. (2005). Debating the Issues: A Tool for Augmenting Critical Thinking Skills of Marketing Students. *Journal of Marketing Education*. <http://doi.org/10.1177/0273475305280533>
- Ryoo Christopher Rodrigues Sara S Baghsorkhi Sam S Stone David B Kirk, S. I., & Hwu, W. W. (n.d.). Optimization Principles and Application Performance Evaluation of a Multithreaded GPU Using CUDA. Retrieved from <https://www.eecis.udel.edu/~cavazos/cisc879-spring2008/papers/ppopp-08-ryoo.pdf>
- Saadé, R., & Bahli, B. (2004). The impact of cognitive absorption on perceived usefulness and perceived ease of use in on-line learning: an extension of the technology acceptance model. <http://doi.org/10.1016/j.im.2003.12.013>
- Saadé, R. G., Tan, W., & Kira, D. (2008). Is usage predictable using belief-attitude-intention paradigm? *Issues in Informing Science & Information Technology*, 5.
- Saade, R., Nebebe, F., & Mak, T. (2011). Interdisciplinary Journal of Information, Knowledge, and Management Knowledge Management Systems Development: Theory and Practice. Retrieved from <http://www.ijikm.org/Volume6/IJIKMv6p035-072Saade472.pdf>
- Sánchez-Franco, M. J., & Roldán, J. L. (2005). Web acceptance and usage model: A comparison between goal-directed and experiential web users. *Internet Research*, 15(1), 21–48.
- Sautter, P. (2007). Designing Discussion Activities to Achieve Desired Learning Outcomes: Choices Using Mode of Delivery and Structure. *Journal of Marketing Education*. <http://doi.org/10.1177/0273475307302014>
- Schmitt, U., & Saadé, R. G. (2017). Taking on Opportunity Divides via Smart Educational and Personal Knowledge Management Technologies. In R. H. Laurie O. Campbell (Ed.), *ICEL 2017 - Proceedings of the 12th International Conference on e-Learning - Google Books* (p. 188). Retrieved from <https://books.google.ca/books?hl=en&lr=&id=2R8zDwAAQBAJ&oi=fnd&pg=PA188&dq=related:8rJhHka2ITMJ:scholar.google.com/&ots=2GJ4geSts0&sig=VO3AK0bNlzDFydaA1QR2Rmz9dXY#v=onepage&q&f=false>
- Scoppio, G., & Luyt, I. (2017). Mind the gap: Enabling online faculty and instructional designers in mapping new models for quality online courses. *Education and Information Technologies*, 22(3), 725–746.
- Sein-Echaluce, M. L., Fidalgo-Blanco, Á., & García-Peñalvo, F. J. (2017). Adaptive and cooperative model of knowledge management in MOOCs, 273–284. http://doi.org/10.1007/978-3-319-58509-3_22
- Senge, P., & Scharmer, O. (2001). Community Action Research 1. *Handbook of Action Research*, 1–32. Retrieved from http://www.ottoscharmer.com/sites/default/files/2001_CAR.pdf
- Serenko, A., Bontis, N., Booker, L., Sadeddin, K., & Hardie, T. (2010). A scientometric analysis of

- knowledge management and intellectual capital academic literature (1994-2008). *Journal of Knowledge Management*, 14(1), 3–23. <http://doi.org/10.1108/13673271011015534>
- Sincak, C., Gunn, J., Conroy, C., Komperda, K., Van Kanegan, K., Krumdick, N., ... Heinking, K. (2017). Transformation of an online multidisciplinary course into a live interprofessional experience. *American Journal of Pharmaceutical Education*, 81(5), 94.
- Soden, B. (2017). The Case of Screencast Feedback: Barriers to the Use of Learning Technology. *Innovative Practice in Higher Education*, 3(1).
- Stacey, R. D. (2001). *Complex responsive processes in organizations: Learning and knowledge creation*. Psychology Press.
- Ştefan, L. (2012a). Immersive collaborative environments for teaching and learning traditional design. *Procedia-Social and Behavioral Sciences*, 51, 1056–1060.
- Ştefan, L. (2012b). Immersive Collaborative Environments for Teaching and Learning Traditional Design. *Procedia - Social and Behavioral Sciences*, 51, 1056–1060. <http://doi.org/10.1016/j.sbspro.2012.08.287>
- Summers, C., Reiff, P., & Weber, W. (2008). Learning in an immersive digital theater. *Advances in Space Research*, 42(11), 1848–1854. <http://doi.org/10.1016/j.asr.2008.06.018>
- Sun, J., Huynh, V.-N., Nakamori, Y., Wu, J., Tian, J., & Xiang, J. (2017). Knowledge Management in Graduate Research. In *Software Quality, Reliability and Security Companion (QRS-C), 2017 IEEE International Conference on* (pp. 480–485). IEEE.
- Sun, P. (2010). Five critical knowledge management organizational themes. *Journal of Knowledge Management*, 14(4), 507–523.
- Teo, T., & Zhou, M. (2017). The influence of teachers' conceptions of teaching and learning on their technology acceptance. *Interactive Learning Environments*, 25(4), 513–527. <http://doi.org/10.1080/10494820.2016.1143844>
- Tezci, E. (2011). Factors that influence pre-service teachers' ICT usage in education. *European Journal of Teacher Education*, 34(4), 483–499. <http://doi.org/10.1080/02619768.2011.587116>
- Thomas, T. D., Singh, L., & Gaffar, K. (2013). The utility of the UTAUT model in explaining mobile learning adoption in higher education in Guyana. *International Journal of Education and Development Using Information and Communication Technology*, 9(3), 71–85. Retrieved from <https://files.eric.ed.gov/fulltext/EJ1071379.pdf>
- Tsoukas, H. (2000). Knowledge as action, organization as theory: reflections on organizational knowledge. *Emergence, A Journal of Complexity Issues in Organizations and Management*, 2(4), 104–112.
- Vallerand, R. J. (1997). Toward a hierarchical model of intrinsic and extrinsic motivation. In *Advances in*

experimental social psychology (Vol. 29, pp. 271–360). Elsevier.

- Van Schaik, P., Martin, S., & Vallance, M. (2012). Measuring flow experience in an immersive virtual environment for collaborative learning. *Journal of Computer Assisted Learning*, 28, 350–365. <http://doi.org/10.1111/j.1365-2729.2011.00455.x>
- Venkatesh, V. (1999). Creation of favorable user perceptions: exploring the role of intrinsic motivation. *MIS Quarterly*, 239–260.
- Venkatesh, V., Morris, M. G., Davis, G. B., & Davis, F. D. (2003). User acceptance of information technology: Toward a unified view. *MIS Quarterly*, 425–478.
- Venkatesh, V., Speier, C., & Morris, M. G. (2002). User acceptance enablers in individual decision making about technology: Toward an integrated model. *Decision Sciences*, 33(2), 297–316.
- Villagrasa, S., Fonseca, D., Redondo, E., & Duran, J. (2014). Teaching Case of Gamification and Visual Technologies for Education. *Journal of Cases on Information Technology*, 16(4), 38–57. <http://doi.org/10.4018/jcit.2014100104>
- Von Krogh, G., Ichijo, K., & Nonaka, I. (2000). *Enabling knowledge creation: How to unlock the mystery of tacit knowledge and release the power of innovation*. Oxford University Press on Demand.
- Wandersee, J. H., Mintzes, J. J., & Novak, J. D. (1994). Research on Alternative Conceptions in Science. In *Handbook of Research of Science Teaching and Learning* (pp. 177–210).
- Wenger, E. C., & Snyder, W. M. (2000). Communities of practice: The organizational frontier. *Harvard Business Review*, 78(1), 139–146.
- Whelan, R. (2008). Use of ICT in education in the South Pacific: Findings of the Pacific eLearning Observatory. *Distance Education*, 29(1), 53–70. <http://doi.org/10.1080/01587910802004845>
- Winkler, K., & Wagner, B. (2018). The relevance of knowledge management in the context of leadership. *Journal of Applied Leadership and Management*, 5(1).
- Wlodkowski, R. J., & Westover, T. N. (1999). Accelerated courses as a learning format for adults. *The Canadian Journal for the Study of Adult Education*, 13(1), 1.
- Woolfolk Hoy, A., Davis, H. A., & Anderman, E. M. (2013). Theories of Learning and Teaching in TIP. *Theory Into Practice*, 52(sup1), 9–21. <http://doi.org/10.1080/00405841.2013.795437>
- Yildirim, S. (2007). Current utilization of ICT in Turkish basic education schools: A review of teacher's ICT use and barriers to integration. *International Journal of Instructional Media*, 34(2), 171.
- Young, M. R. (2005). The Motivational Effects of the Classroom Environment in Facilitating Self-Regulated Learning. *Journal of Marketing Education*. <http://doi.org/10.1177/0273475304273346>
- Zboralski, K. (2009). Antecedents of knowledge sharing in communities of practice. *Journal of Knowledge Management*, 13(3), 90–101.

APPENDIX F PAPER 3

This paper was presented at Informing Science Institute Conference 2016 – include full paper – to publish in Management & Education , or Information & Management

Title: An experiment on Immersive Learning within the context of Evidence Based Management (EBM).

Authors:

Samie Li Shang Ly, Concordia University
Raafat Saade, Concordia University

Abstract

This study introduces the combination of an environment (Immersive learning), a method (Evidence Based Management (EBM) and a mindset (Knowledge management SECI Model) to evaluate the effectiveness of students' current learning methods and their exposure to research evidence from academic journals. We found the immersive learning environment engaged students, hence improved their examination performance and their understanding of the course material. When exposed to research evidence, none of the groups whether immersive or tradition paid much attention but simply focused on keywords. Which we believe is a result of traditional learning and we wish to make a change as education is the foundation to knowledge creation and will be transferred towards professional careers in Business.

Introduction + Motivation

The larger scope of this research project revolves around 3 interlocking elements of knowledge management such as education, job opportunities-networks and social performance. Education is the foundation of the next two elements as students need to

learn how to formulate answerable questions (Ask), search for evidence (Acquire), critically appraise the evidence (Appraise), apply evidence to practice (Apply) and monitor their outcomes (Assess) as defined by Barends, E. G., and Briner, R. B. (2014). With a solid foundation in education, can skills develop to later translate knowledge ready to use in collaboration through a network as mentions Quik, W. H., Wright, N. J., Rashid, A., and Herjanto, H. (2014) “Collaboration has also been defined as a “process of participating in knowledge communities”...“in a coordinated, synchronous task to construct and maintain a shared conception of a problem”. Ultimately, with acquired knowledge, used in collaboration, professionals can make social changes such as solving complex social environments in poverty (Andersson, 2009).

In this particular study, the focus is on education only, where we combine an environment (Immersive), a method of learning (Evidence Based Management (EBM) and a mindset (SECI Model - knowledge management) to assess the current university level education environment, methods and philosophy.

In the next section, we will define the aforementioned key elements in their theoretical background.

Literature Review

Previous researchers have indirectly examined these three elements and have conducted research in immersive learning methods, in evidence based management, as well as Nonaka’s SECI model in knowledge management. However, the integration of the three elements as a holistic set up to knowledge creation in education has not been seen, therefore we take the first steps to look at this combination.

Immersive Learning –Setting an environment of learning

Immersive Learning has evolved as a context setting of an atmosphere for learning that facilitates student interaction and engagement (Auster and Wylie, 2006). Student learning styles are no longer the same due to technology advances, classroom sizes, and educational curriculum. Consequently, pedagogical models have transformed from unidirectional teacher-to-student instruction to a dynamic IT based learning environment. In comparison to traditional passive learning styles, Inks and Avila (2008), show that active learning strategies are more effective. To explore the advantages of immersive learning, this environment ties together three learning styles such as experiential, constructivist, and collaborative.

Experiential learning is an environment and a context as defined by Barab and Duffy (2000). For example, students will understand cultural history by visiting a country, or visiting a mountain, a lake to examine its microscopic ecosystem. Although these activities are not available in regular classroom setting, technology can allow education to create environments that enhances human senses in order to make experiences more enjoyable, and memorable (Karns, 2005).

Constructivist learning takes into consideration the process of active knowledge construction to emphasizes on a student's prior knowledge and focus on challenging the student with their existing misconceptions of a subject matter (Von Glasersfeld, 1993; Wandersee, Mintzes, and Novak 1994; Fernandes, Raja, and Eyre 2003).

This learning style highlights the autonomy of the student to achieve learner-centered instructional activities and not teacher-centered. According to Driscoll (2000) constructivist learning styles are centered around cognitive and developmental

perspectives of Piaget (An intellectual development focusing on intuition, believing, remembering and perceiving, the nature of knowledge about how humans acquire, construct and use it), the interaction and cultural emphases of Vygotsky (higher cognitive functions in children that saw reasoning emerge from practical activities in a social environment, he also posited the concept of Zone of proximal development where the acquisition of new knowledge is dependent on previous learning and available instruction) and Bruner (who believed the outcome of cognitive development is thinking, where the intelligent mind creates from experience, in which a generic coding system allows an individual to go beyond the data and interpret predictions), the contextual nature of learning, the active learning of Dewey (He encouraged and believed in experimental intelligence and plurality) (Ştefan, 2012b).

Collaborative or social learning consist of creating student interactions within a group where students share one another's resources and skills. As technological advancement today allows international communications, an increasing trend of interactive global learning is presented.

Evidence Based Management, a technique

Evidence Based Management (EBM) has been studied to understand the practicality of education in Management sciences as authors Trank (2015), Minzberg (2004), Charlier, Brown and Rynes (2011) have observed a gap between academic researchers and industry practioners. EBM becomes important as a learning theory, and methods attempt to move professional decisions away from practioners' personal preference and often un-systematic experience but towards scientific evidence (Rousseau, 2006). EBM has been

observed within different educational settings, however, little has been shown on how effective and how much do students understand when using academic research in practice cases. In the next part, we would like to emphasize on a few studies on the availability of EBM in school curriculum, the ways EBM provides a powerful way to looking at information for future practioners and finally the role of academics and practioners in providing the right environment for EBM.

In an investigation of MBA Classes, Charlier, Brown and Rynes (2011), they found 25% of MBA courses from their study uses EBM in some form, however the implementation of such a method requests the instructor to understand academic information and usually are Ph.D holders. Quoted by L.Burke and Rau (2010:132) “Strengthening the teaching-research nexus holds vast potential to deliver not only the skills need to understand research to generations of upcoming managers, but also to instill values that recognize the validity of research.”

Briner , Denyer & Rousseau, (2009:19) explains the practice of EBM is making decisions through careful study of information from 4 sources such as the practioner’s expertise and judgment, evidence within the local context, the critical evaluation of research evidence and the stakeholders (Briner, Walshe, 2014). Briner and Walshe, 2014 stresses the importance of overview available evidence which at times may be a wide range of contradictory evidence before making a balanced decision. Moreover, they believe the technique of doing systematic reviews not only applies to academics but also should be taught to practioners.

Despite its advantages, there are many obstacles in bridging the gap between practioners and academics because they occupy separate worlds (Rynes, Giluk and

Brown, 2007). Difference can be the language usage, the researcher's conscientiousness to provide information functional to practitioners, and the conflicts about what counts as effectiveness (Trank, 2015). Both academics and practitioners share different values in the use of research evidence, academic focus on publications while practitioners focus on the usage of information for a specific context that may change from one to another.

Hence, the role of academics, educators, and practitioners are important. All three play an essential part to supporting the practice of EBM. The development of distinctive knowledge and skills depends on what is found in each of these communities (Briner, R. B., Denyer, D., & Rousseau, D. M. (2009)).

Ultimately, research evidence found, collected by academics is used by practitioners, therefore scholars could put themselves in the mindset of transferring knowledge to organizations, government policy (Kaplan, 2008), the performance of firms (Stefan, A., & Paul, L. (2008)). As for practitioners, they need to acquire, assess, adapt and apply research evidence to their decision.

Nonaka's knowledge management – a philosophy

Nonaka, Ikujiro and Takeuchi (1996) introduced the SECI Model of knowledge creation as an important foundation of knowledge creation and knowledge transfer. Many researchers since then have looked into organizations and their knowledge management such as Zorgios, Vlismas, Venieris (2009) in the software development process, Richtner, A., Åhlström, P., & Goffin, K. (2014) in New Product Development, Andreeva, T., & Ikhilchik, I. (2011) in a cultural context. Although widely researched in organizations, we

would like to take this perspective and implemented at the foundation of organizational activities such as university level education and alter on professional training. The SECI model shows the transformation of tacit knowledge that is passed on through practice, guidance, imitation and observation in an environment of collaborative setting. Then through externalization by documenting information, to be combined into creating new knowledge that is finally learnt and internalize with practice of explicit knowledge.

Building our experiment based on Immersive learning with a focus on experiential environments where students can do hands on activities to serve as a memorable more enjoyable experience than tradition book and reading learning, we also want to create an environment taking the students' learning speed and prior knowledge into account and finally to allow them to help each other through collaboration. Hence, the Peer to Peer learning management system was created.

Technology

After teaching undergraduate level classes for 3 years, we came to a realization that students need engagement in their studies in order to explore their critical thinking, analytical skills. Lectures alone are no longer enough, especially as classrooms and enrolment of students increase year after year. The advantage is the accessibility to technology advances that allow us to create programs tailored to students' collaborative work.

During one of my statistics class, we observed that students fail to engage with the classroom, even though the class was taught with the most innovative methods such as animated videos explaining theories and exercises. As a result, I cancelled the lecture and allowed students to work together in creating their own quiz questions. Surprisingly,

students did not only engage in their course material, but also found the motivation to ask creative, critical questions. They also were engaged in teaching their peers how they came up with these questions. In a discussion with Professor Raafat Saade, he mentioned he also went through the same experience and created a program imitating this process on a learning management system. This program is called the Peer to Peer Interactive learning system.

The Peer to Peer Question Generation System is an in-house automated question creation program developed by Professor Raafat Saade. There are 3 phases to the process wthat highly involves students. In phase 1, students are asked to read documents, then create their own questions. In phase 2, students will then rate the questions generated by difficulty and quality. In phase 3, the moderator will select the top quality and selected difficulty sets of questions and allow students to take a quiz.

This program will serve as a basis to our study as it provides experiential, constructivist and collaborative immersive learning components and will allow us to take a step further to introduce course material using EBM methods and observe knowledge creation. The purposes in this research are two-fold. First, to evaluate the usefulness of immersive learning using a Peer to Peer system (P2P). Second to combine academic readings and real life cases as an enhancement to EBM practice in classrooms.

Hypotheses

There are two main questions we would like to explore, first the performance of students in immersive studying environments and traditional studying environment, second, the usage of research evidence in the context of undergraduate university level studies in business disciplines.

Hypothesis 1: Students who learn in an immersive environment perform better than students who use passive learning methods. (Immersive vs. traditional)

Hypothesis 2: Students utilize research evidence provided to them in their studies.

Methodology

Table 1: Research Design to evaluate Hypothesis 1 and 2

	Group A1- Immersive	Group B- Traditional
Part I - Theory Students will be given theory only reading material based on academic journals.	Group A will go through the P2P learning process from phase 1 to 3 (such as question creation, question evaluation and examination based on the readings)	Group B will only perform the examination stage of the P2P program. The examination taken by these students were generated by students in Group A1 and A2.
	Group A2- Immersive	
Part II – Theory + Evidence Students will be given theory and data reading material based on academic journals	Group A will go through the P2P learning process from phase 1 to 3 (such as question creation, question evaluation and examination based on the readings)	

Sample and Data Collection: A sample of 1st year and 2nd year University students was chosen. 1st year students enrolled in BTM 200 a business technology management introductory course, and 2nd year students are enrolled in COMM 226 a Management Information Systems introductory course. All students were randomly assigned into groups to be part of Group A or Group B.

Sample representativeness: In the context of this research question, the undergraduate level in business studies are representative of future leaders and learning styles which will be applied in industry work.

Group A (Immersive) students were given a set of readings on project management theories and research evidence in the style of academic journals. Students were guided by the researcher through a trial of the P2P program, followed by 1 hour 30 minutes of reading and question creation. They were asked to create 5 multiple choice questions with 4 answer choices of varying level of difficulty and high quality.

There were three levels of difficulty presented as follows by the researcher:

- Hard Question: requires critical thinking, beyond the text
- Medium Question: requires analysis, within or beyond the text
- Easy Questions: Good understanding of the text, within the text

There were three levels of quality presented as follows by the researcher:

- High Quality: Grammatically correct, precise and clear
- Medium Quality: Well written, clear
- Low Quality: Hard to understand, to be discarded

In the assessment stage of the P2P System, multiple raters graded each question to ensure inter-rater reliability of each question. Questions were shown, however the answers were hidden to avoid students memorizing.

Afterwards, students were given 15-20 minutes to evaluate 30 questions created from their peers, after a 10 minutes break, students were given 25 minutes to attempt a 15 multiple choices exam.

Group B (traditional) students were given the same set of readings as Group A with theory and evidence. Students were guided into a quiet study room and given 1 hour to 1 hour 30 minutes to work on the course material. When ready, they were given 25 minutes to attempt a traditional printed exam of 15 multiple choice questions.

At the completion of the activity, students were granted 2% bonus marks in their respective university course.

Hypotheses 1 and 2 will allow us to discriminate between traditional passive learning and immersive learning, as well as EBM elements of students' studying methods.

Results and Discussion

Results for Hypothesis 1

Hypothesis 1: Students who learn in an immersive environment perform better than students who use passive learning methods. (Immersive vs. traditional)

In order to test Hypothesis 1, we used an ANCOVA test to overview the difference in score between Immersive and Traditional Groups (A: Immersive coded 1, B: Traditional coded 2). The total sample consisted of 25 students in Immersive condition and 43 students in Traditional learning condition. See Table 1 for brief descriptive statistics.

Between-Subjects
Factors

		N
group	1	25
	2	43

Descriptive Statistics

Dependent Variable: grades

group	Mean	Std. Deviation	N
1	9.6500	2.50416	25
2	8.0233	2.44451	43
Total	8.6213	2.57227	68

Statistical Analysis – ANCOVA test on Group A (Immersive) and Group B (Traditional)

The Immersive condition scored higher than the Traditional condition taking into account the difficulty of each multiple-choice question. Moreover, the Levene's test showed that both variances in Group A and B are similar. See Table 2.

Table 2: Levene's test, variance check

Levene's Test of Equality of Error Variances^a
 Dependent Variable: grades

F	df1	df2	Sig.
.000	1	66	.984

Tests the null hypothesis that the error variance of the dependent variable is equal across groups.

a. Design: Intercept + avgdifficulty + group

Using an ANCOVA test, we took into consideration the average difficulty of each test as the difficulty level of each section varied (See Appendix A for an example of the P2P System). It has been found that the model is significant and there is a difference between the Immersive and the Traditional learning groups. See Table 3.

Table 3: ANCOVA Test between Immersive (Group A) and Traditional (Group B) learning methods

Tests of Between-Subjects Effects
 Dependent Variable: grades

Source	Type III Sum of Squares	df	Mean Square	F	Sig.
Corrected Model	43.131 ^a	2	21.566	3.503	.036
Intercept	13.314	1	13.314	2.163	.146
avgdifficulty	1.297	1	1.297	.211	.648
group	42.781	1	42.781	6.949	.010
Error	400.180	65	6.157		
Total	5497.563	68			
Corrected Total	443.312	67			

a. R Squared = .097 (Adjusted R Squared = .070)

Item Response Theory Analysis on Group A (Immersive) and Group B (Traditional)

Although ANCOVA can only show the performance results, in order to examine further, we ran an Item Response Theory (IRT) analysis on the overall examinations of both Group A and Group B taking into account the answer choices given by each student, the wrong answer choices given by each student.

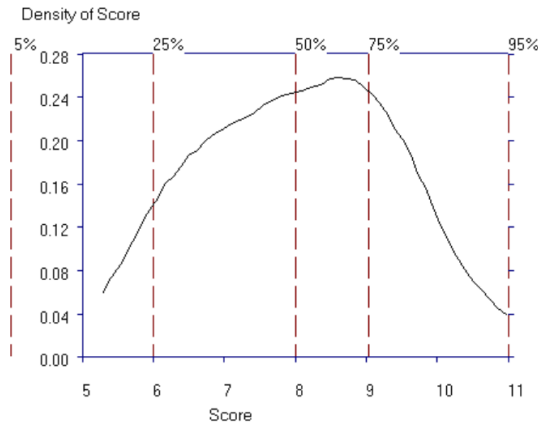

Figure 1- Density of score Group B (Traditional)

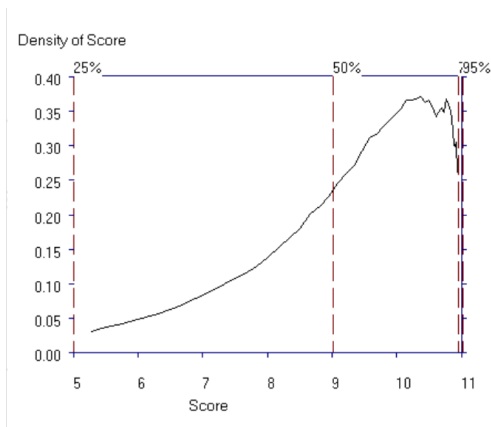

Figure 2- Density of score group A (Immersive)

A comparison between figure 1 and figure 2, we can see that the immersive group's scores are negatively skewed meaning more students scored higher whereas students who used the traditional learning method scored a normal distribution. This is also an indication that the examination was fair in terms of the difficulty of the exam for the traditional condition students. We can also say that for immersive students, the examination was easier since their assessment of questions did not show any answers as a control to discourage students from memorizing answers.

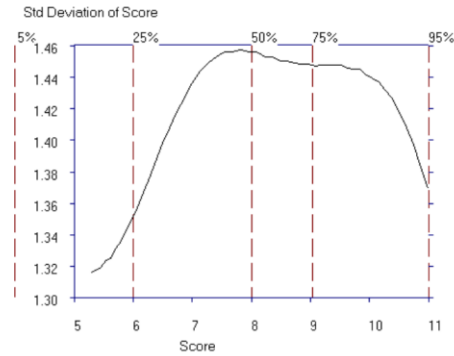

Figure 3- Standard Deviation (Traditional)

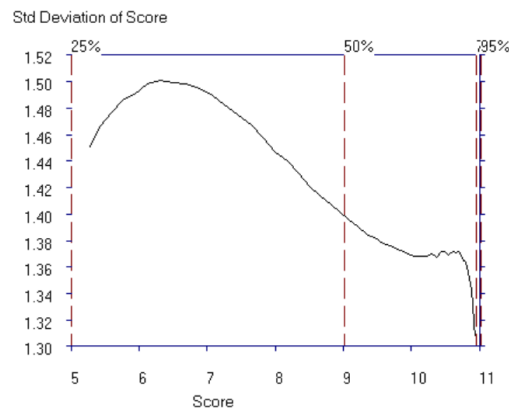

Figure 4-Standard deviation (Immersive)

Different students or the same student may not always choose the same choices, figure 3 and figure 4 show the proficiency level of students such that students in traditional methods who score between 50% to 82% in the exam have more fluctuation in their choices of answers than students with extreme low and high proficiency.

Students utilizing the suggested immersive method of learning have high fluctuations in their answers for students who scored between 25-45%, also the dip in figure 4 indicates that high proficiency scorers have more consistent choices in their answers. We can see that the examination for immersive students decreases in fluctuation of answer choices as students' expected proficiency becomes higher.

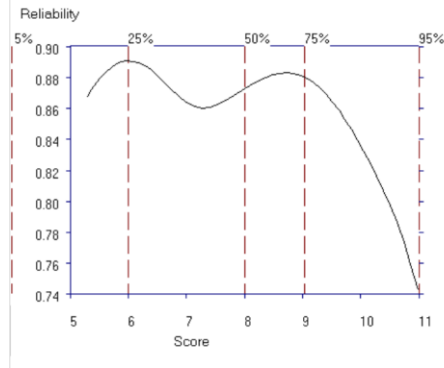

Figure 5-Reliability (Traditional)

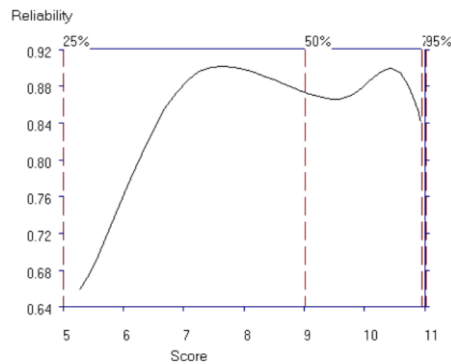

Figure 6-Reliability (Immersive)

The reliability curve is used to verify test quality, whenever the test is most powerful to determine the abilities of students. The reliability for traditional test takers is high (between 0.86 -0.89) for students who scored between 0 and 75%, in contrast, for immersive students, the test had higher reliability for students who scored between 45%-95%. See figure 5 and 6. A high reliability test takes into account the number of questions students answered correctly, whether the questions answered were difficulty or easy, and whether the correctly answered items were high quality or not and whether the answer chosen is typical of a stronger or weaker examinee. A high reliability indicates that the test is most powerful to discriminate between high proficiency students and low proficiency students.

To make the point, we can see that for traditional test takers, the exam created by their peers were only powerful for low to mid proficiency students such that the analysis can detect common answers by these students. As for the immersive group, the test taken was powerful to indicate the ability of learning by high to mid proficiency scorers.

Discussion for Hypothesis 1

Therefore we can conclude for this section that Immersive environment allow students to have higher performance in their tests in comparison to tradition conditions. Immersive students also find it easier while the test is fair for traditional test takers. Interestingly, the generated exams by the P2P program has more fluctuation in answer choices for mid proficiency students in tradition conditions while this fluctuation decreases for immersive students as their proficiency increases. The exams are also more powerful to discrimination students who are in low to mid proficiency for tradition conditions while the exam is more powerful for mid to high proficiency for immersive conditions. Meaning the generated questions were of good enough quality to discriminate between the skills of students. As a result, Hypothesis 1 is rejected.

Results for Hypothesis 2

Hypothesis 2: Students utilize research evidence provided to them in their studies.

We observed learning methods of students and asked whether research evidence help students understand course material better, and whether such evidence is taken into account by students when they are studying. Taking an exploratory point of view, we

conducted an analysis of the most common highlighted words in each text given by students.

In order to evaluate the use of EBM within theoretical course material, we asked all students to bring a highlighter and use it on the text.

Group A2 and Group B were given the same text with theory and data.

- 1) It was shown that Group A1 (Immersive with Theory Only) and Group A2 (Immersive with Theory and data), both highlighted similar points.

- 2) Group A2, completely omitted the data part of the text and solely worked as if there was no data. As seen on Figure 7. Group A were the Immersive groups as well as the exam creators, since Group A2 did not take into account the research evidence portion of the text, the exam did not have any questions reflecting the data.

- 3) Another observation are the highlighted sections of Group B, most participants also omitted the data section of the text. Although 4/37 did look at the data. See Figure 8.

Validation of Project Management Critical Success Factors - A Critical Analysis

James Wan, Ronald George Squire, Modified by James Li Shang

ABSTRACT
This study examines project management critical success factors and critical success factors. The study was conducted as an exploratory study to determine the validity of the PMBOK Guide. The study was conducted as an exploratory study to determine the validity of the PMBOK Guide. The study was conducted as an exploratory study to determine the validity of the PMBOK Guide.

INTRODUCTION
In today's rapidly changing world, the project management approach, due to its evident importance, continues to be identified by government and non-profit organizations. These organizations have increasingly been introducing their work into programs, projects and initiatives. The PMBOK Guide provides the project management approach to the project management profession in the United States organizations ("US") have widely used project management certification with US agencies, implementation of the PMBOK Guide is critical to the success of the project.

The Concept of Certification
Brockhaus and Stovall (2011) state that the certification is a formal recognition of an individual's knowledge, skills, and abilities. It is a formal recognition of an individual's knowledge, skills, and abilities. It is a formal recognition of an individual's knowledge, skills, and abilities.

PMBOK - A Guide to the Project Management Body of Knowledge (PMBOK® Guide), Project Management Institute, 2009 is one of the global top ten standards for those engaged in project management. The PMBOK® Guide was first published as a standard by the Project Management Institute in 1996, and has been revised several times since then, most recently, 2008. The PMBOK® Guide is a

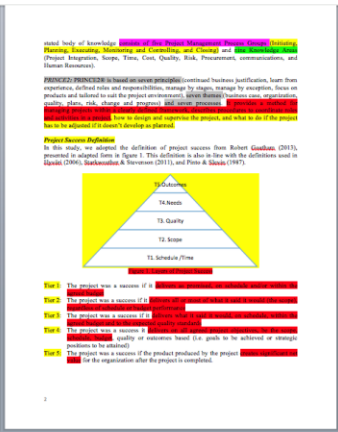

Evaluation (Brockhaus and Stovall, 2011) study the relationship of project management and certification by using the Brockhaus and Stovall (2011) model. The Brockhaus and Stovall (2011) model is a model that is used to evaluate the relationship between project management and certification. The Brockhaus and Stovall (2011) model is a model that is used to evaluate the relationship between project management and certification.

Core Success Factors
Brockhaus and Stovall (2011) study the relationship of project management and certification by using the Brockhaus and Stovall (2011) model. The Brockhaus and Stovall (2011) model is a model that is used to evaluate the relationship between project management and certification. The Brockhaus and Stovall (2011) model is a model that is used to evaluate the relationship between project management and certification.

RESEARCH HYPOTHESES
The Brockhaus and Stovall (2011) model is a model that is used to evaluate the relationship between project management and certification. The Brockhaus and Stovall (2011) model is a model that is used to evaluate the relationship between project management and certification. The Brockhaus and Stovall (2011) model is a model that is used to evaluate the relationship between project management and certification.

RESEARCH METHOD AND DATA

Context of Study
The context of the study was the implementation of PMBOK® in the United States. The context of the study was the implementation of PMBOK® in the United States. The context of the study was the implementation of PMBOK® in the United States.

Method and Data Collection
This study utilized descriptive case studies (Glaser, 2006; Stakeholder & Stakeholder, 2011) as the basis to build our survey and data collection.

Table 1 Critical Success Factors in the Current Study

CSF	Definition
1. Ability to communicate and work in teams	Ability to communicate and work in teams
2. Ability to work with people and teams	Ability to work with people and teams
3. Ability to work with people and teams	Ability to work with people and teams
4. Ability to work with people and teams	Ability to work with people and teams
5. Ability to work with people and teams	Ability to work with people and teams
6. Ability to work with people and teams	Ability to work with people and teams
7. Ability to work with people and teams	Ability to work with people and teams
8. Ability to work with people and teams	Ability to work with people and teams
9. Ability to work with people and teams	Ability to work with people and teams
10. Ability to work with people and teams	Ability to work with people and teams
11. Ability to work with people and teams	Ability to work with people and teams
12. Ability to work with people and teams	Ability to work with people and teams
13. Ability to work with people and teams	Ability to work with people and teams
14. Ability to work with people and teams	Ability to work with people and teams
15. Ability to work with people and teams	Ability to work with people and teams
16. Ability to work with people and teams	Ability to work with people and teams
17. Ability to work with people and teams	Ability to work with people and teams
18. Ability to work with people and teams	Ability to work with people and teams
19. Ability to work with people and teams	Ability to work with people and teams
20. Ability to work with people and teams	Ability to work with people and teams

Source Factors related to Project Success

Source Factor	Definition
1. Business development (new products)	Business development (new products)
2. Customer/Client satisfaction	Customer/Client satisfaction
3. Financial performance (ROI, EBITDA)	Financial performance (ROI, EBITDA)
4. Innovation (new products)	Innovation (new products)
5. Market share	Market share
6. Operational excellence	Operational excellence
7. Quality	Quality
8. Risk management	Risk management
9. Talent management	Talent management
10. Technology adoption	Technology adoption
11. Workforce productivity	Workforce productivity

Source Findings and Data Analysis

Comparison of study with Stakeholder and Stovall's on PMB certification

Study	Stakeholder and Stovall's	%
Multiple levels	Multiple levels	100%
Technical knowledge and skills	Technical knowledge and skills	100%
Ability to deal with ambiguity and change	Ability to deal with ambiguity and change	100%
Effective Leadership	Effective Leadership	100%
Strong verbal communication	Strong verbal communication	100%
Working Autonomy	Working Autonomy	100%
Workload	Workload	100%
Ability to resolve	Ability to resolve	100%
PMB or PMBOK related	Education	100%
Education	Education	100%
Length of prior experience	Length of prior experience	100%
PMB not on checklist	PMB not on checklist	100%

Table 6 Comparison with Stakeholder & Stovall's study

In an attempt to improve the results, it presents high similarity to Stakeholder and Stovall's study in terms of the ranking of the criteria, and it is consistent due to the Project Management Institute's study that shows that the PMBOK Guide is a

agreement of which was, also along with Education, Length of prior experience and Past work experience, that are significantly lower than the top ranked factors, to both the current and previous studies. Accordingly, it can be said that the PMBOK Guide is not a universal standard.

RESEARCH CONCLUSIONS
The Brockhaus and Stovall (2011) model is a model that is used to evaluate the relationship between project management and certification. The Brockhaus and Stovall (2011) model is a model that is used to evaluate the relationship between project management and certification. The Brockhaus and Stovall (2011) model is a model that is used to evaluate the relationship between project management and certification.

Limitations
The Brockhaus and Stovall (2011) model is a model that is used to evaluate the relationship between project management and certification. The Brockhaus and Stovall (2011) model is a model that is used to evaluate the relationship between project management and certification. The Brockhaus and Stovall (2011) model is a model that is used to evaluate the relationship between project management and certification.

Figure 7- Highlighting sections of test creators

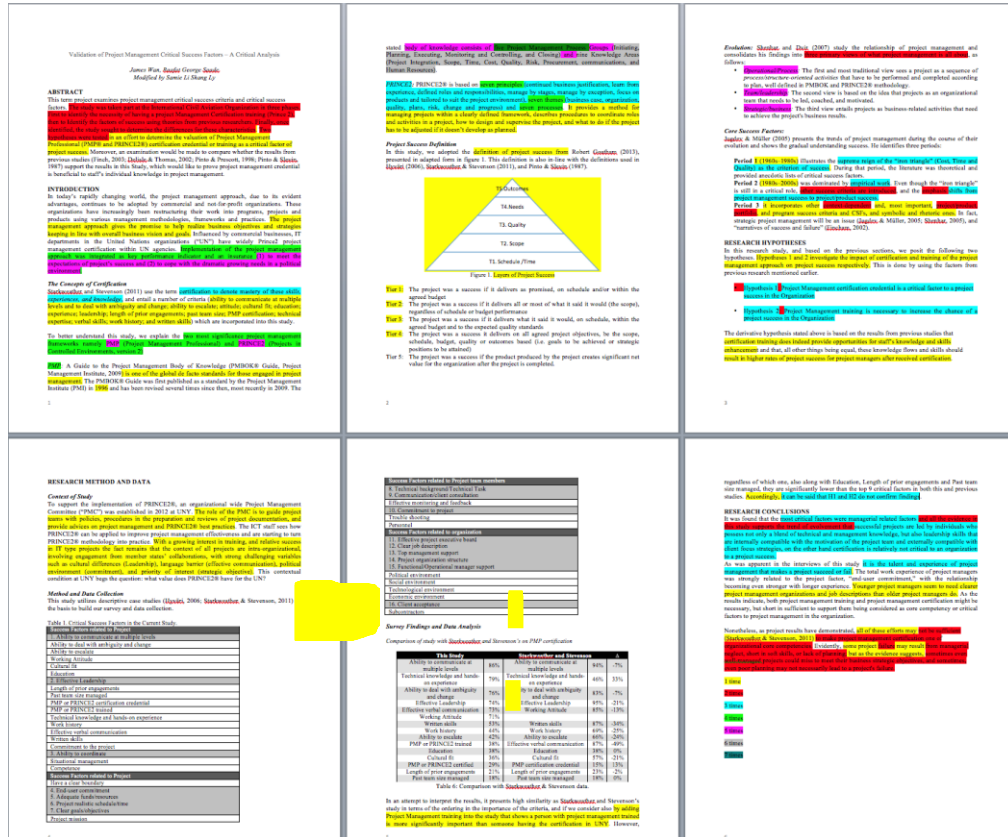

Figure 8- Highlighted sections for Traditional Test Takers

In a selected sample of 37 students GROUP B (Traditional) who used highlighters, only 1 critically looked at the data values and observed an error within the course material. While 21 students fully omitted the data section even given enough time to study. See Table 4.

Table 4- Group B results in highlighted text

Number of Students	GROUP B (Traditional)
1	Critically looked at the data values
3	Slightly looked at the data values
12	Highlighted key sections, but did not look at the data
21	Completely omitted the Data section
37	Total students

Discussion of Hypothesis 2

The presence of evidence based management still needs improvement as students learning behaviors are still theoretical. They do not process their understanding by looking at data provided to them, instead they focus on keywords.

Results from Students with Theory and Data, as test creators. Based on Figure 7, the compilation of highlighting marks of the test for test creators, all test creators omitted the data section and did not ask any questions based on data. This is indicative of the importance of research evidence for undergraduate studies proving that evidence based management may not be an effective method in lower level studies. As a result, Hypothesis 2 is not rejected.

In the next section of the results and discussion, we asked students a few questions about their learning methods and their experience.

Results for feedback of test creators Group A1, and Group A2.

As a result from the feedback given by test creators, most students enjoyed creating questions as it helped them understand the material. They said it “allows them think

critically and assimilate knowledge”. However they feel that this program should be used only for certain classes and with oversight from the professor. It is a good way to study for an exam to come. When asked to create hard questions, they were challenged but found it rewarding.

When asked “*Has the program helped you understand material better?*”, all students said yes.

Results from Group B traditional test takers

In a sample of 41 students, we asked them the following questions:

How effective was your studying methods?

Students preferred more interaction, more practice and more hands on experience.

They do not like that fact that many university courses are based on memorization and suggested course should focus on understanding the material. Many using the traditional method did not feel confident about their results and mentioned their studying method was keyword based.

If we told you, your peers generated the examination written today during their study period, do you think their questions were relevant to the text?

40 said the questions were relevant, 1 said they were not relevant.

How different are the questions compared to a University level quiz?

Students found a good balance between straight-forward questions and abstract questions that require thinking and understanding of the material provided. Most found the level to be the same. See Table 5.

Table 5-level of difficult of the generated exam in comparison to university quizzes

Number of Students	
---------------------------	--

26	The same
10	Less Tricky
5	More Tricky

Limitations

One may argue that the students were not incentivized to perform at their best, however, this says a lot about how students learn on their own time, and it had to be performance based for the evaluation to count. In the realm of consulting, a lot of work is done without explicit reward, however it is the curiosity and the knowledge acquired from such exposure that creates a good advisor. Based on this experiment, we can see that students do not go beyond their comfort zone and this has to be changed. The emphasis in evidence based management is not well adapted in today’s educational system since students look for keywords and expect quizzes to touch on them. As a reflection to practioners, much of their experience come from the curiosity to learn, hence allows them to be critical thinkers.

Managerial Implications

One of the main goals of this study is to evaluate the necessity of learning methods and the reactions of student towards immersive learning environment. Students in business disciplines are future consultants and practioners. As proposed by previous literature in EBM, both scholars and practioners must want to communicate harmoniously to be able to exchange valuable resources. Knowledge management in University classes is therefore the foundation to future practioners.

This student contributes to the understanding of business theories taught in University and how students see course material. We also noticed a lack of usage of research evidence by both the test creators and test makers. Although the suggest immersive learning method resulted in high performance, the teacher who moderates the sessions play a large role in making sure the material is learnt properly. The same can be said about organizations where continuous training is important. The most crucial aspect is to engage students in understanding their material in theory and through hands on activities in order to elevate their critical thinking skills for their professional careers later on.

Future Research

In future studies combining Immersive learning, Evidence Based Management and Knowledge Management, we wish to look at higher level courses such as the MBA, MSc in Administration level as these students learnt to implement their knowledge into industry. We also wish to keep in mind knowledge creation in organization and observe how training programs are constructed within corporations.

Conclusion

We were able to confirm that Immersive Learning is an essential tool to engage students in their studies. Immersive learning motivates critical thinking as students were challenged to create harder questions. We also found that the generation of such questions is can be equivalent to university level courses given by professors. Although a caution should be said about the important role of the instructor to provide clear guidelines to students when experiencing immersive learning. Another finding is the systematic approach of learning through memorization and key words observed by undergraduate students. Although many mentioned they wish to understand the material,

there becomes a vicious cycle of spotting keywords when learning and we believe this should be changed as we propose to view education in business as knowledge creation through the SECI model which will benefit future consultants and professionals in their careers.

References

- Andersson, K. (2009). Motivational dilemmas in collaborative learning activities: The case of the Swedish International Development Cooperation Agency (SIDA). *Public Administration and Development*, 29(5), 341-351.
- Andreeva, T., & Ikhilchik, I. (2011). Applicability of the SECI model of knowledge creation in Russian cultural context: theoretical analysis. *Knowledge and Process Management*, 18(1), 56-66.
- Auster, E. R., & Wylie, K. K. (2006). Creating active learning in the classroom: A systematic approach. *Journal of Management Education*, 30(2), 333-353.
- Barab, S. A., & Duffy, T. (2000). From practice fields to communities of practice. *Theoretical foundations of learning environments*, 1(1), 25-55.
- Barends, E. G., & Briner, R. B. (2014). Teaching Evidence-Based Practice: Lessons From the Pioneers An Interview With Amanda Burls and Gordon Guyatt. *Academy of Management Learning & Education*, 13(3), 476-483.
- Briner, R. B., & Walshe, N. D. (2014). From passively received wisdom to actively constructed knowledge: teaching systematic review skills as a foundation of evidence-based management. *Academy of Management Learning & Education*, 13(3), 415-432.
- Briner, R. B., Denyer, D., & Rousseau, D. M. (2009). Evidence-based management: concept cleanup time?. *The Academy of Management Perspectives*, 23(4), 19-32.
- Burke, L. A., & Rau, B. (2010). The research-teaching gap in management. *Academy of Management Learning & Education*, 9(1), 132-143.
- Charlier, S. D., Brown, K. G., & Rynes, S. L. (2011). Teaching evidence-based management in MBA programs: What evidence is there?. *Academy of Management Learning & Education*, 10(2), 222-236.
- Charlier, S. D., Brown, K. G., & Rynes, S. L. (2011). Teaching evidence-based management in MBA programs: What evidence is there?. *Academy of Management Learning & Education*, 10(2), 222-236.
- Driscoll, P.M. (2000). *Psychology of Learning for Instruction*, Allyn&Bacon, Massachusetts.
- Fernandes, K. J., Raja, V., & Eyre, J. (2003). Cybersphere: the fully immersive spherical projection system. *Communications of the ACM*, 46(9), 141-146.
- Inks, Scott A., and Ramon A. Avila. 2008. "Preparing the next Generation of Sales Professionals through Social, Experiential, and Immersive Learning Experiences." *Journal for Advancement of Marketing Education* 13 (4): 47-55. <http://www.mmaglobal.org/JAME-Archive/JAME-Winter-2008/JAMEWinter2008v.13p.47-55.pdf>.
- Kaplan, S. N. (2008). Are US CEOs Overpaid?. *The Academy of Management Perspectives*, 22(2), 5-20.
- Karns, G. L. (2005). An update of marketing student perceptions of learning activities: Structure, preferences, and effectiveness. *Journal of marketing Education*, 27(2), 163-171.
- Mintzberg, H. (2004). *Managers, not MBAs: A hard look at the soft practice of managing and management development*. Berrett-Koehler Publishers.
- Nonaka, I., Toyama, R., & Hirata, T. (2008). *Managing flow: A process theory of the knowledge-based firm* (Vol. 19). New York: Palgrave Macmillan.
- Quik, W. H., Wright, N. J., Rashid, A., & Herjanto, H. (2014). Collaborative Networked Learning in Manufacturing. *International Journal of Advanced Corporate Learning*, 7(4).
- Richtnér, A., Åhlström, P., & Goffin, K. (2014). "Squeezing R&D": A Study of Organizational Slack and Knowledge Creation in NPD, Using the SECI Model. *Journal of Product Innovation Management*, 31(6), 1268-1290.
- Rousseau, D. M. (2006). Is there such a thing as "evidence-based management"?. *Academy of management review*, 31(2), 256-269.

- Rynes, S. L., Giluk, T. L., & Brown, K. G. (2007). The very separate worlds of academic and practitioner periodicals in human resource management: Implications for evidence-based management. *Academy of Management Journal*, 50(5), 987-1008.
- Stefan, A., & Paul, L. (2008). Does it pay to be green? A systematic overview. *The Academy of Management Perspectives*, 22(4), 45-62.
- Ştefan, Livia. 2012. “Immersive Collaborative Environments for Teaching and Learning Traditional Design.” *Procedia - Social and Behavioral Sciences* 51: 1056–60. doi:10.1016/j.sbspro.2012.08.287.
- Trank, C. Q. (2014). “Reading” Evidence-Based Management: The Possibilities of Interpretation. *Academy of Management Learning & Education*, 13(3), 381-395.
- Von Glasersfeld, E. (1993). Reflections on number and counting. *The development of numerical competence: Animal and human models*, 225-243.
- Wandersee, J. H., Mintzes, J. J., & Novak, J. D. (1994). Research on alternative conceptions in science. *Handbook of research on science teaching and learning*, 177, 210.
- Zorgios, Y., Vlismas, O., & Venieris, G. (2009). The SECI Model and the Learning Curve Phenomenon. *Proceedings of The European Conference on Intellectual Capital*, 589-599.

APPENDIX A – Sample view of P2P Learning system

<input type="checkbox"/>	Question	Quality	Difficulty	Total Ratings	
<input checked="" type="checkbox"/>	The project management approach gives the promise to ____	100	100	1	
<input checked="" type="checkbox"/>	If the project management certification is beneficial to the staffs' individual knowledge, which factor would be the most critical likelihood for a project to succeed?	100	100	1	
<input checked="" type="checkbox"/>	What period illustrates the supreme reign of the "Iron Triangle"(Cost, Time and Quality) as the criterion of success?	100	33.33	1	
<input checked="" type="checkbox"/>	What are key elements that made an individual more adept to successfully manage a project?	100	66.67	1	
<input checked="" type="checkbox"/>	Bill's first project with his company delivered what it promised, was finished on time, did not exceed the predetermined budget and met the company's standards of quality. In what tier would Bill's project be considered a success?	100	66.67	2	
<input checked="" type="checkbox"/>	What kind of project management certification is used within the UN?	100	66.67	1	
<input checked="" type="checkbox"/>	Which element is most important in delivering a successful project ?	100	66.67	2	
<input checked="" type="checkbox"/>	Which of the following factors can make the project management certification one of the organisational competencies?	100	66.67	4	
<input checked="" type="checkbox"/>	Bill has been elected as team leader for his company's next big project. He wants the project to follow a framework that is clearly defined. This is his first time being project leader so he wants to know how to design and supervise the project. What significant project framework would Bill benefit from adhering to?	91.67	83.33	4	
<input checked="" type="checkbox"/>	_____ use the term certification to denote mastery of these skills, experiences, and knowledge.	88.89	77.78	3	
<input checked="" type="checkbox"/>	What is the difference between younger project managers and older project managers.	88.89	88.89	3	
<input checked="" type="checkbox"/>	A company gives free time to their employee so they can work on personal project. If the project is good, the company will give its support. Which primary view of project management is the company adopting according to Shenhar and Dvir?	83.33	83.33	2	
<input checked="" type="checkbox"/>	Romeo and Juliet clothing company decided to deliver 200 pieces of hand made winter scarves and mittens via air to Montreal -based clothing store, named LOL . Romeo and Juliet company will be charged extra \$ 300.00 if shipped via air , so the company decided to deliver the products via shipping line called MY BOAT in order to meet their budget. LOL received the products on time and was happy about the quality of the products. The scenario belongs to which layer of success?	77.78	88.89	3	
<input checked="" type="checkbox"/>	For a lazy students who only wants to submit his work on time and does not really care about his grade, what would be his definition of success?	66.67	83.33	2	
<input checked="" type="checkbox"/>	As the project management principle evolves, will it be in-line with the present definition?	66.67	83.33	2	

APPENDIX G PAPER 4

This paper was presented in Informing Science Institute Conference Vietnam 2017 Investigating performance using a collaborative system. – to publish in Journal Education Psychology Perspective, Educational Technology Research and Development, Journal of Educational Research, International Journal of e-collaboration.

Title: Knowledge Management IT tool: An Investigation within a Marketing Introductory Course

Authors:

Samie Li Shang Ly, Concordia University
Raafat Saade, Concordia University

Abstract:

Aim/Purpose: This study seeks to acknowledge a change in knowledge management theories by considering micro-level interactions (human factors), social contexts. We measure what motivates knowledge creation and whether perceptions have changed over time.

Background: We emphasize on Nonaka et al. (2000's three key elements: SECI model, Ba, Leadership as well as current knowledge management researchers critiques and improvements.

Methodology: Based on an introductory marketing course, we used an in-house web based learning tool (peer to peer) to capture score performances and perception surveys (Davis, 1989). The analysis was conducted through an exploratory factor analysis (EFA).

Contribution: This study shed light on current knowledge management critiques by providing measures at the micro-level and community level.

Findings: Perceptions of adaptability and usefulness change positively over time, while students' repeated practice prepare them for different styles of questions as their performances increases over time.

Keywords: Immersive Learning, Collaborative Learning, Marketing

Introduction

Immersive learning environments have been a popular exploration in the literature, very often researchers have focused on the improvement of tactile skills, virtual reality graphics. However there seem to be a lack of focus on the knowledge acquisition. In this paper, we would like to emphasize on existing knowledge management models, mainly on Nonaka et al. (2000)'s work and current researcher's critiques Gourlay (2006) and suggestions (von Krogh et al., 2000a ; Harsh, 2009; Jakubik, 2011;) within an immersive learning context.

In response to the embedded importance of Information Technology today, we believe it plays a crucial role in enhancing learning environments. We channeled and measured students learning and knowledge management using a web-based learning tool with immersive features. This tool was presented to a classroom of 113 non-business students from 41 disciplines (from computational arts, economics to child studies) during an introductory marketing course. As a result, we were able to observe performance over time and investigate on students' perception on their adaptability and usefulness of this immersive learning tool.

Theoretical Framework

Current research in knowledge management have revised Nonaka's SECI model and suggested modifications as well as improvements. There has been an apparent shift

towards more dynamic knowledge management models where 3 overarching themes have appeared in the literature. Gourlay, (2006), Heisig, (2009), Nonaka (2008) mentioned in order to achieve high quality knowledge management, it is important to understand human factors and behaviors at the micro level of interactions. On the other hand, (Cook and Brown, 1999; Tsoukas, 2000; von Krogh et al. 2000a, pp. 3-44, Zboralski, 2009; Sun, 2010) focused on the need to look at enabling factors within a context, more specifically within a community to understand how knowledge is created. As the third theme, building on Nonaka and Konnoo (2000)'s identification of a "ba" environment for knowledge creation, (Stacey, 2004; Senge et al., 2005; Gourlay, 2006) questioned transformational changes in knowledge creation while Bernier and Bowen (2004), experimented on creating an environment and testing its control and agility of knowledge development in a virtual setting (Harsh, 2009).

Micro-Level Interactions: The Human Factor

Researchers such as (Hardaker, Smith, 2002, Nonaka et al., 2008, Heisig, 2009, Jakubik, 2011), acknowledge the field of knowledge management has shifted and reached a new phase where the acquisitions of concepts need to be human-focused, mainly people, culture and leadership. To support their claim, Jakubik (2011) defined the micro-level perspective of human behavior and engagement by mentioning the topic of immersion centered interaction based on psychologist Csikszentmihalyi (1991, pp. 88-89)'s flow theory. Similarly, Senge and Scharmer (2001, p. 247) believed knowledge creation is an "intensely human, messy process of imagination, invention and learning from mistakes, embedded in a web of human relationships". Based on Csikszentmihalyi (1991)'s interpretation of flow experience, individuals share common clear goals with

meaning to their experience, they receive feedback, they experience interactions that create feelings, they have a sense of control over the feeling of possibilities of choices and new things. More importantly, each individual have an intrinsic motivation, commitment where mistakes are treated as a learning process and challenges arise to push their limits.

On the practical end, Hardaker, Smith, (2002) argued with the increase in information, organizations cannot continue to ignore innovation and knowledge transfer. Very often they seek too much control on the learning process without giving enough freedom to their employees. When building products, initiatives, they should focus on the needs of their staff members. In the same line, Grant and Baden-Fuller (2000), Wenger and Snyder (2000), Jakubik (2008), mentioned knowledge creation is shifting from a firm oriented to a network and community oriented knowledge process where knowledge is created through peer to peer interactions, commentaries, dialogues and reconceptualization.

Communities , contexts, Enabling factors

“The focus on human is not enough”, mentioned Jakubik (2008), not only does the focus need to be at a micro-level, the scope should be contextual. Wenger (2000), Jakubik, (2008) quotes “. . . groups of people informally bound together by shared expertise and passion for joint enterprise [. . .] People in communities of practice share their experiences and knowledge in free-flowing, creative ways that foster new approaches to problems.

Researchers mentioned multiple characteristics of communities such that guidance is needed at the beginning, but they can become self-sustained (Cook and

Brown, 1999; Tsoukas, 2000; Zboralski, 2009; Sun, 2010), collaborative learning approaches enhance critical thinking (Hardaker and Smith, 2002), individuals become responsible of their own learning where they follow a process of questioning the existence of solutions and assumptions while seeking for new possibilities (Fagerholm and Helela ;, 2003, pp. 23-6, Jakubik,2008).

von Krogh et al. (2000a) interpreted Nonaka and Takeuchi's SECI model differently when describing the transformation in the focus of content such as capturing, locating, transferring, sharing existing knowledge to contexts of knowledge creation taking into account enabling conditions (instill a vision, manage conversations, mobilize activists, create the right context, globalize local knowledge) that result in increased new innovations. This is in line with Hardaker, Smith (2002)'s thoughts on a missed opportunity from learners to participate in an exchange of ideas where the appropriate level of interactivity is meaningful. This problem can now be answered via social communities enabled by the advancement of Information Technology (IT) which they could not in the past.

Control

With an understanding of human factors, contexts of knowledge creation, researchers Stacey (2004), Senge et al. (2005), Gourlay (2006) believe the notion of transformative change is largely unexplored. Gourlay (2006), Harsh (2009) criticized on how explicit knowledge is not always externalized tacit knowledge, but it is the representation of ongoing practices and the ability to exercise control over knowledge over a period of time.

Control of an environment, includes the challenge of working with limited information as a survival technique to information overload. Hence the ability of an individual to detect value added information through a learning driven process (Cross, 1976) allows knowledge to be useful and reusable which consequently can increase the efficiency of knowledge creation (Hardaker, Smith, 2002Harsh, 2009).

As an example, Bernier and Bowen (2004) have applied text-based online discussion forums as an attempt to control an environment and gain an ability to measure knowledge in virtual social context. Although it is only the start of understanding knowledge management within organization, Arling and Chun (2011, p. 231) mentioned, organization still need to understand how to manage knowledge in order to achieve their goals.

Based on this literature review, researchers' suggestions and criteria, we seek to build on the environment defined by Nonaka et al. (2000)'s 3 key elements such as the SECI model, a mechanism used in exploring knowledge transformation from tacit to explicit (artifact). Ba, a platform to advance collaboration and knowledge sharing (task) and the initiative, motivation of individuals within this marketing course to lead creative ideas (person).

Methodology

The Context

During the semester of Fall 2016, in an undergraduate course in Marketing at John Molson School of Business, Concordia University, Montreal, Quebec, Canada, we presented to 113 enrolled students an in-house design learning system called Peer to Peer System (p2p). The class consisted of non-business background students from

computational arts to child studies majors. This course served as an elective where students learn basic concepts of marketing such as business strategy, pricing models, segmentation, branding, digital marketing. Many students have an interest in trying a course from a different field, while others have the motivation to pursue a bachelor's degree in business in the near future. The learning objectives were based on an understanding of basic concepts in theory, the ability to write and structure a marketing report, the ability to research primary and secondary data and the knowledge to apply theories to a real life company.

In an effort to study for their midterm exam and final exam made of essay questions and multiple choice questions on concepts and applications, students were asked to use the Peer to Peer system in two instances throughout the semester, once before the midterm and once before the final exam.

The process

The Peer to Peer system allows for students to actively participate in the creation of questions within a social context where their peers provide feedback on the quality, clarity and relevance of their ideas. Students follow a 3 phase process. In Phase 1, students are given a specific amount of time to review their learning material on marketing concepts based on lectures and their book. When ready, they are required to submit a predetermined number of questions (in this case, 5 multiple choice questions with 5 answer options, 1 easy, 2 medium, 3 hard). Once submitted, the teacher moves the cohort to phase 2. In Phase 2, the p2p tool randomly provides each student with a predetermined number of questions generated by their peers. They proceed to evaluate each question with a rubric of relevance, clarity and difficulty on a scale of 1-10 (low to

high). The system also ensures students will not receive their own questions. The p2p system consequently stores evaluated questions which represents a body of knowledge learnt by the students. Once questions have been assessed, the teacher closes the phase. Arriving at Phase 3, the teacher views all questions created, through sorting based on their preferred criteria, the teacher generates one or more tests from the pool of student generated questions in the format of a quiz or a test. Questions are sorted and selected based on higher quality (clarity, relevance) and three difficulties (easy, medium, hard).

Given each student profile includes students' ethnic background and gender, the teacher has the option of specifying sub pools of questions for students to take and from students who created.

Experimental Design

This study looks at two perspectives of knowledge creation amongst students; their perception of the Peer to Peer system and their performances using the Peer to Peer system as a training/collaborative platform.

In part 1, students were asked to complete a questionnaire at two instances: after their midterm p2p activity, and after their final p2p activity. The questionnaire was based on Davis 1989's perceived usefulness and ease of use of professional software on a 7-point likert scale. Through an exploratory factor analysis (EFA), we try to determine significant construct(s) which we believe will be close to Davis' 1989 "perceived usefulness" and "ease of use" in order to understand students' perceptions of the system. We will then be able to compare two sets of data over two periods of time and identify whether changes in perception occurred.

In part 2, we would like to quantify students' performances to see whether reusability and redundancy increases performance for students. At 4 instances, they were tested on their ability to answer multiple-choice questions. First, 2 tests were created during their midterm p2p activity. One week later, they were given 20 questions in their midterm exam, 10 from the pool of peer-to-peer questions generated and 10 from a teacher's made pool of questions. Within a pool of 130 questions generated at the midterm p2p activity, 40 questions of highest quality, relevance, clarity and rating were selected and 10 were drawn for the midterm exam. On the other hand, the teacher also created a pool of 15 questions where 10 were randomly drawn from, for the midterm. The methodology used in part 2 involved mapping out the scores of students to observe trends of performances on 4 tests.

Results & Analysis

Part 1 – Exploration on students survey about knowledge creation tool.

With an Exploratory Factor Analysis (EFA), we were able to detect 3 constructs, based on the set of items, we named the constructs as Adaptability, Perceived usefulness, Future Use for the midterm phase and 2 constructs (Adaptability, Perceive usefulness) for the final exam phase. In order to confirm statistical assumptions, we ran two Bartlett's tests, which were respectively significant showing there is equal variance within in variable.

The Cronbach alpha for all 5 constructs were highly significant, meaning each item from the survey explained the construct well. Specifically, Adaptability- 6 items (midterm) yield Cronbach alpha $\alpha=.918$, Perceived Usefulness-4 items (midterm) $\alpha =.899$, Future use-2 items (midterm) $\alpha =.927$, Adaptability- 6 items (final) $\alpha =.955$,

Perceived Usefulness-6 items (final) $\alpha = .936$. All construct were well explained by their respective items (Table 1 & Table 2).

Table 1. EFA summary for Midterm Exam Constructs

Code	Midterm Exam Components, sample of 71	Cronbach Alpha if item deleted	Item total correlation
Adaptability			
A1M	My interactions in P2P Program is clear and understandable.	.912*	.680
A2M	I am skillful at using P2P Program.	.904*	.759
A3M	Learning to use the P2P Program is easy for me.	.894*	.873
A4M	I find it easy to get the P2P Program to do what I want it to do.	.898*	.825
A5M	I have the resources necessary to use the learning systems (websites) at the university.	.896*	.825
A6M	I have the knowledge necessary to use the learning systems (websites) at the university.	.905*	.751
A7M	A specific person (or group) is available for assistance with learning systems (websites) difficulties.	.925*	.556
Cronbach Alpha for the 6 items = .918; Mean (SD) = 5.249 (.062)			
Perceived Usefulness			
U1M	I find the P2P Program useful.	.870*	.773
U2M	Using P2P Program enables me to accomplish learning tasks more quickly.	.899*	.704
U3M	Using P2P Program increases the effective use of my time in handling learning tasks/assignments.	.840*	.857
U4M	Using P2P Program increases the quality of my learning tasks at minimal efforts.	.868*	.777
Cronbach Alpha for the 4 items = .899; Mean (SD) = 5.018 (.063)			
Future Use			
F1M	I intend to continue using the P2P system.	N/A	.865
F2M	I predict that I would use the P2P system in the future.	N/A	.865
Cronbach Alpha for the 2 items = .927; Mean (SD) = 4.817(.004)			
*significant			

Table 2. EFA summary for Final Exam Constructs

Code	Final Exam Components, sample of 20	Cronbach Alpha if item deleted	Item total correlation
Adaptability			
A1F	My interactions in P2P Program is clear and understandable.	.949*	.832
A2F	I am skillful at using P2P Program.	.946*	.870
A3F	Learning to use the P2P Program is easy for me.	.948*	.842
A4F	I find it easy to get the P2P Program to do what I want it to do.	.944*	.918
A5F	I have the resources necessary to use the learning systems (websites) at the university.	.946*	.874
A6F	I have the knowledge necessary to use the learning systems (websites) at the university.	.945*	.883
A7F	A specific person (or group) is available for assistance with learning systems (websites) difficulties.	.958*	.725
Cronbach Alpha for the 6 items = .955; Mean (SD) = 5.600 (.029)			
Perceived Usefulness			
U1F	I find the P2P Program useful.	.921*	.846
U2F	Using P2P Program enables me to accomplish learning tasks more quickly.	.916*	.876
U3F	Using P2P Program increases the effective use of my time in handling learning tasks/assignments.	.919*	.854
U4F	Using P2P Program increases the quality of my learning tasks at minimal efforts.	.946*	.663
U5F	I intend to continue using the P2P system.	.922*	.834
U6F	I predict that I would use the P2P system in the future	.923*	.820
Cronbach Alpha for the 4 items = .936; Mean (SD) = 5.175 (.041)			
*significant			

Based on the factor analysis means (Figure 1), we can see both common constructs (adaptability and perceived usefulness) have increased from the midterm to the final exam. Due to their repeated use of the p2p system, they found the tool to be more useful and easier to adapt to. Moreover, the 2 item construct of Future use is relevant as

47% of students foreseed using the system again while 27% said maybe and 27% did not foresee using the system again (Figure 2).

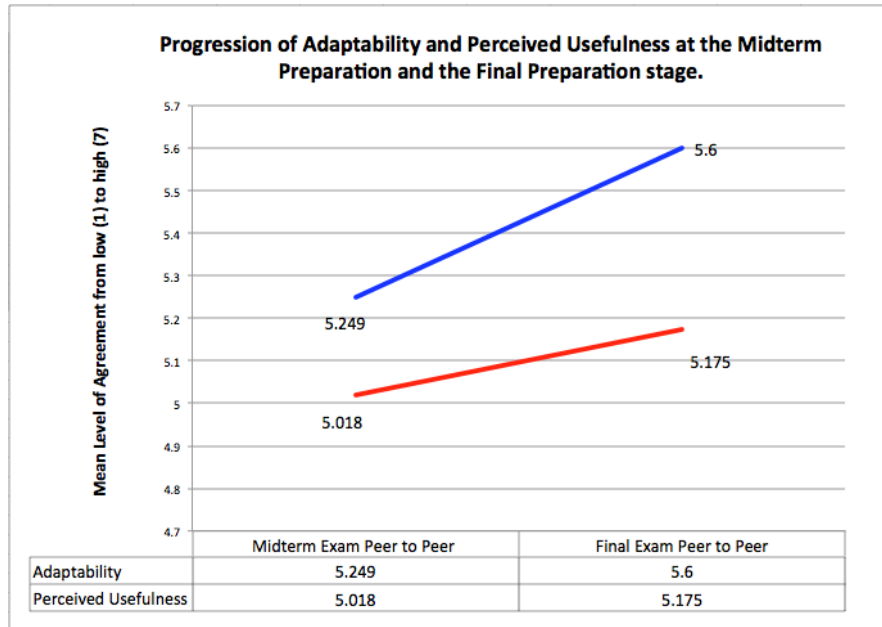

Figure 1. Comparison of means from midterm to final phase on adaptability and perceived usefulness

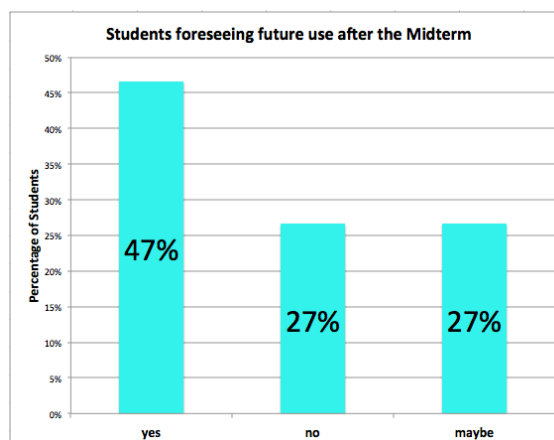

Figure 2. Summary of results for Future use construct at the midterm phase

We then considered individual average factor values and interpreted the transformation in perception from midterm to final. When looking at individual responses we identified the following:

1. “drop in confidence” when their midterm to final response decreased
2. “reinforcement in confidence” when their midterm to final response increased
3. “consistent confidence” when their midterm to final response stayed the same.

The results show, 40% of students who dropped in confidence can be interpreted as being aware of their knowledge and taking failure as a learning process. On the other hand, 47% of students became more confident which can be seen as a sign of opportunity to study using a learning tool and a sign of participating in an exchange of ideas (Figure 3).

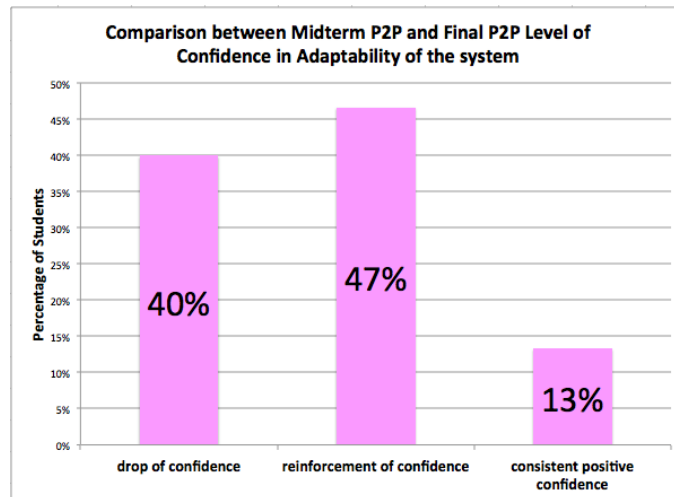

Figure 3. Summary of confidence in Adaptability of the system over time.

In addition, we interpret individual average factor scores on the construct of usefulness with the following:

1. If the midterm to final score decreased, students found the system to be less useful over time
2. If the midterm to final score increased, students found the system to be more useful over time

3. If the midterm to final score stayed the same, students' perceived usefulness did not change over time.

33% of students did not change their perception over time, while 40% of student found the p2p tool to be more useful and 27% found the p2p tool to be less useful over time (Figure 4). These results help us understand at an individual level the effectiveness of the p2p tool.

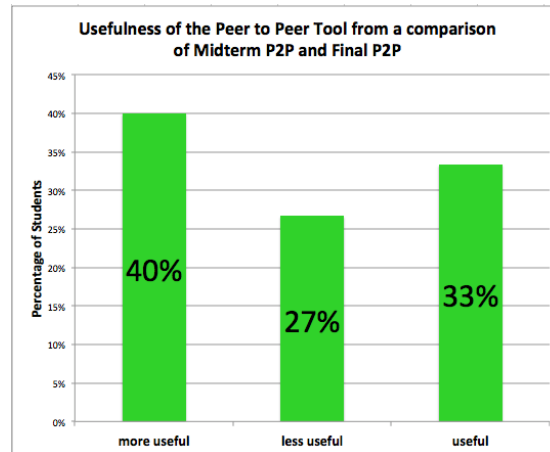

Figure 4. Summary of perceived usefulness of the system over time.

PART 2 – Analysis of a 4 stage process in knowledge reusability and time

In part 2 we were able to observe the performance in test scores of a sample of 20 students in the course at 4 instances. First during their p2p midterm activity, they were asked to complete 2 tests (p2p trial 1, p2p trial 2), then one week later, students were given 10 random questions pooled from the p2p activity filtered with higher quality and 10 questions randomly pooled from a teacher created bank.



Figure 5. Progression map of student performances

Table 3. Example of a table

	p2p trial 1	p2p trial 2	p2p mid	teacher mid
Mean	68.5%	69.3%	91.7%	74.5%
SD	17.86%	24.277%	8.405%	17.06%
N	20	20	20	20
Min	26%	25%	70%	50%
Max	96%	100%	100%	100%
Pool of Questions	130	130	40	15

Looking closely at the performances of 20 students in the course, we can see a larger fluctuation of the first two trials (p2p trial 1 and p2p trial 2) where their standard deviations varied respectively 17.86% and 24.27% meaning there is a larger distribution

of the grades amongst students, some are scoring higher and some lower. Interestingly, the performance of the p2p midterm questions increased with a mean of 91.7% and a reduction in the standard deviation to 8.045%, which shows that as a whole, the group became more consistent in scoring with fewer fluctuations. The lowest score for the p2p midterm was 70% which is considered high.

On the other hand, the performance of students increased less when faced with teacher created questions where students averaged a score of 74.5% with a smaller fluctuation of a standard deviation of 17.06%. The teacher created question was designed to create control and investigate on whether students learnt concepts or memorized multiple choice question structures. It is apparent; the two p2p trials where students studied based a pool of 130 questions helped them perform on similar style questions at the midterm as the p2p midterm questions. However, when faced with teacher created questions, students were uncomfortable with a new style and a new language different from their peers on the same concepts. Interestingly, they performed better overall, which suggests the peer-to-peer preparation prepared them for both types p2p and teacher made at the midterm exam.

Finally, when asked what method of study would they actually use the p2p tool for, in Figure 6, students responded mostly (59%) to study for an exam at the midterm, the percentage increased to 70% at the final preparation stage. On the other hand, while 19% found the system useful to learn in regular classes, the percentage decreased to 5% at the final preparation stage. They overall believe it is useful for exam studies, sometimes in group studies and tutorial but not too much to learn in regular classes.

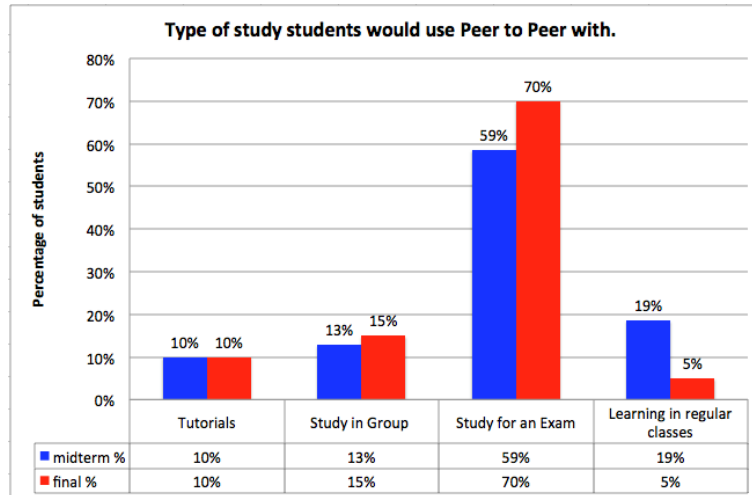

Figure 6. Type of studying method students see the use for p2p

Discussion

A further understanding of the context, in this case a cohort of students enrolled in an introductory marketing class with the common social goal of studying for their examinations allows us as researchers to investigate on the micro-level and community context. We found a variety of factors through this study allowing us to explain the context of knowledge creation in this cohort with measures of confidence in usage, perceived usefulness, adaptability and future use. An aggregate measure individuals' perception showed the ease of use and confidence have increased over time from midterm to final period.

In addition, we question based on student performances whether the speed to knowledge acquisition can be increased via a learning system similar to the peer to peer where students learn by collaboration, sharing and documenting their knowledge with other students. This brings in an interesting topic of time of knowledge acquisition, which Harsh (2009) alluded to where time/efficiency in learning allows for reusability of knowledge. In our case, knowledge was reused (pool of p2p question used in the

midterm), students performed significantly better with similar questions, but also were able to perform with a different style of questions (teacher made).

Although a lot of work needs to be done in this scope of knowledge management and knowledge creation, this study sheds light on how students gain an ability to detect and create useful knowledge that allows increased efficiencies in their knowledge creation.

Future research

This study opens a path of insights in the mechanics of a learning environments at the human and community level work. We would like continue on the investigation of student engagement level during the activity as well as through out time. Moreover, the community environment creates many possible scenarios in compatibility of knowledge creation within the same discipline (business marketing and business decision sciences) as well as between different disciplines (engineering and business). Such findings translate directly to business situations where the field is supported by multi-disciplinary projects.

Managerial Implications

Innovation and knowledge transfer are key characteristics of a relevant business, this study reinforces the need of organizations to focus on human relationships, immersing a sense of ownership and control over ideas created by employees, produce a network of strong ties of member motivated to achieve a common goal. This research emphasizes on allowing humans to converse with one another, to exchange ideas, to give feedback and to instill failure and trial as a positive learning process to innovation. All stakeholders within an organization (managers, staff, shareholders) should take a

mentorship role that encourages every member to create useful knowledge and ease knowledge transfer toward the company vision.

Conclusion

The p2p learning tool presents to all stakeholders of knowledge management (the teacher, researcher and students) a process of measurement at the micro-level while considering human factors through recorded data such as time of completion, performance scores, customized test creation. Moreover, the p2p learning tool also offers social context features such as peer-to-peer feedback, automation with teachers' dashboard view of the cohort as a whole which enables statistical analysis. Through an immersion centered learning experience as defined by Csikszentmihalyi (1991, pp. 88-89), and a teacher led activity, students are given the freedom to create new ideas, they are provided a social context with a common mission, they receive feedback, they experience feelings, and they gain a sense of control on their own knowledge acquisition.

This study therefore addresses a few of the concerns raised by knowledge management researchers and fill in the gap in improvements of knowledge management at the foundation of Nonaka et al. (2000)'s SECI model of transforming tacit knowledge to explicit knowledge (mechanism), Ba, a platform to advance collaboration and knowledge sharing (peer to peer learning tool), and individuals led in a social context of learning through leadership (person).

References

- Arling, P. A., & Chun, M. W. (2011). Facilitating new knowledge creation and obtaining KM maturity. *Journal of knowledge management*, 15(2), 231-250.
- Barker, R. (2015). Management of knowledge creation and sharing to create virtual knowledge-sharing communities: a tracking study. *Journal of Knowledge Management*, 19(2), 334-350.
- Bernier, R., & Bowen, J. P. (2004). Web-based discussion groups at stake: The profile of museum professionals online. *Program*, 38(2), 120-137.
- Cook, S. D., & Brown, J. S. (1999). Bridging epistemologies: The generative dance between organizational knowledge and organizational knowing. *Organization science*, 10(4), 381-400.
- Cross, K. P. (1976). *Accent on Learning. Improving Instruction and Reshaping the Curriculum*.
- Fagerholm, H., & Helelä, M. (2003). *Handbook for Transforming a BBA Program in International Business Into a Problem-based Learning Curriculum: Case: Liibba Program at Helia*. Helsinki Business Polytechnic.
- Flow, C. (1990). *The psychology of optimal experience*. Harper&Row, New York.
- Gourlay, S. (2006). Conceptualizing knowledge creation: a critique of Nonaka's theory. *Journal of management studies*, 43(7), 1415-1436.
- Grant, R. M., & Baden-Fuller, C. (2000). Knowledge and economic organization: an application to the analysis of interfirm collaboration. In *Knowledge Creation* (pp. 113-150). Palgrave Macmillan UK.
- Hardaker, G., & Smith, D. (2002). E-learning communities, virtual markets and knowledge creation. *European business review*, 14(5), 342-350.
- Harsh, O. K. (2009). Three dimensional knowledge management and explicit knowledge reuse. *Journal of Knowledge Management Practice*, 10(2), 1-10.
- Heisig, P. (2009). Harmonisation of knowledge management-comparing 160 KM frameworks around the globe. *Journal of knowledge management*, 13(4), 4-31.
- Jakubik, M. (2008). Experiencing collaborative knowledge creation processes. *The learning organization*, 15(1), 5-25.
- Jakubik, M. (2011). Becoming to know. Shifting the knowledge creation paradigm. *Journal of Knowledge Management*, 15(3), 374-402.
- Mariano, S., Mariano, S., Awazu, Y., & Awazu, Y. (2016). Artifacts in knowledge management research: a systematic literature review and future research directions. *Journal of Knowledge Management*, 20(6), 1333-1352.
- Mitchell, R., & Boyle, B. (2010). Knowledge creation measurement methods. *Journal of Knowledge Management*, 14(1), 67-82.
- Nonaka, I., Toyama, R., & Konno, N. (2000). SECI, Ba and leadership: a unified model of dynamic knowledge creation. *Long range planning*, 33(1), 5-34.
- Senge, P., & Scharmer, C. (2011). *Presence: Exploring profound change in people, organizations and society*. Nicholas Brealey Publishing.
- Stacey, R. D. (2001). *Complex responsive processes in organizations: Learning and knowledge creation*. Psychology Press.
- Sun, P. (2010). Five critical knowledge management organizational themes. *Journal of Knowledge Management*, 14(4), 507-523.
- Tsoukas, Haridimos. *Complex knowledge: Studies in organizational epistemology*. Oxford University Press, 2005.
- Von Krogh, G., Ichijo, K., & Nonaka, I. (2000). *Enabling knowledge creation: How to unlock the mystery of tacit knowledge and release the power of innovation*. Oxford University Press on Demand.
- Wenger, E. C., & Snyder, W. M. (2000). Communities of practice: The organizational frontier. *Harvard business review*, 78(1), 139-146.

Zboralski, K. (2009). Antecedents of knowledge sharing in communities of practice. *Journal of Knowledge Management*, 13(3), 90-101.

APPENDIX H CHAPTER 6 PART 1 EFA

KMO and Bartlett's Test^a

Kaiser-Meyer-Olkin Measure of Sampling Adequacy.		.838
Bartlett's Test of Sphericity	Approx. Chi-Square	1598.945
	df	105
	Sig.	.000

Goodness-of-fit Test^a

Chi-Square	df	Sig.
44.866	40	.275

Total Variance Explained

Factor	Initial Eigenvalues			Extraction Sums of Squared Loadings			Rotation SS
	Total	% of Variance	Cumulative %	Total	% of Variance	Cumulative %	Loadings ^b Total
1	6.514	43.426	43.426	6.237	41.581	41.581	4.506
2	2.018	13.454	56.880	1.301	8.676	50.257	4.537
3	1.582	10.547	67.428	1.203	8.018	58.275	3.955
4	1.223	8.153	75.581	.832	5.544	63.819	5.028
5	.957	6.378	81.959	1.459	9.726	73.545	1.732
6	.581	3.875	85.834				
7	.416	2.775	88.609				
8	.377	2.514	91.123				
9	.350	2.332	93.455				
10	.270	1.800	95.255				
11	.209	1.394	96.648				
12	.160	1.066	97.715				
13	.132	.882	98.597				
14	.111	.743	99.340				
15	.099	.660	100.000				

Extraction Method: Maximum Likelihood.

APPENDIX I CHAPTER 6 PART 2 CFA

Structure Matrix

	Factor				
	1	2	3	4	5
TM_1	-.085	-.060	-.065	.071	.799
TM_2	.151	.152	.127	.429	.692
TM_3	.009	-.082	-.072	.146	.833
IM_1	.434	.431	.443	.466	-.136
IM_2	.254	.312	.471	.964	.229
IM_3	.212	.325	.490	.859	.209
EJ_1	.349	.512	.966	.539	.074
EJ_2	.284	.402	.612	.274	-.249
EJ_3	.490	.614	.860	.556	-.006
EF_1	.842	.487	.444	.310	-.021
EF_2	.916	.464	.313	.246	.048
EF_3	.870	.468	.346	.213	-.050
CE_1	.573	.802	.485	.347	.010
CE_2	.436	.892	.479	.315	-.053
CE_3	.476	.911	.601	.359	-.045

Extraction Method: Maximum Likelihood.

Rotation Method: Promax with Kaiser Normalization.

KMO and Bartlett's Test

Kaiser-Meyer-Olkin Measure of Sampling Adequacy.	.818	
Bartlett's Test of Sphericity	Approx. Chi-Square	1358.931
	df	105
	Sig.	.000

Total Variance Explained

Factor	Initial Eigenvalues			Extraction Sums of Squared Loadings			Rotation SS
	Total	% of Variance	Cumulative %	Total	% of Variance	Cumulative %	Loadings ^a Total
1	5.687	37.911	37.911	4.999	33.324	33.324	3.821
2	2.474	16.496	54.407	2.044	13.624	46.948	4.163
3	1.763	11.755	66.163	1.242	8.277	55.225	3.972
4	1.204	8.023	74.186	1.237	8.248	63.474	3.320
5	.907	6.048	80.234	1.250	8.335	71.809	2.004
6	.575	3.836	84.071				
7	.501	3.339	87.410				
8	.367	2.444	89.854				
9	.343	2.289	92.142				
10	.296	1.975	94.118				
11	.258	1.723	95.840				
12	.183	1.220	97.060				
13	.169	1.125	98.185				
14	.138	.923	99.109				
15	.134	.891	100.000				

Extraction Method: Maximum Likelihood.

a. When factors are correlated, sums of squared loadings cannot be added to obtain a total variance.

	CR	AVE	MSV	MaxR(H)
Immersion IM	0.818	0.618	0.338	0.909
Functionality EF	0.907	0.765	0.272	0.914
Cognitive Expectancy CE	0.900	0.751	0.421	0.915
Enjoyment EJ	0.850	0.662	0.421	0.918
Timelessness TM	0.813	0.593	0.069	0.826

No Validity Concerns

APPENDIX J CHAPTER 6 PART 3 SEM

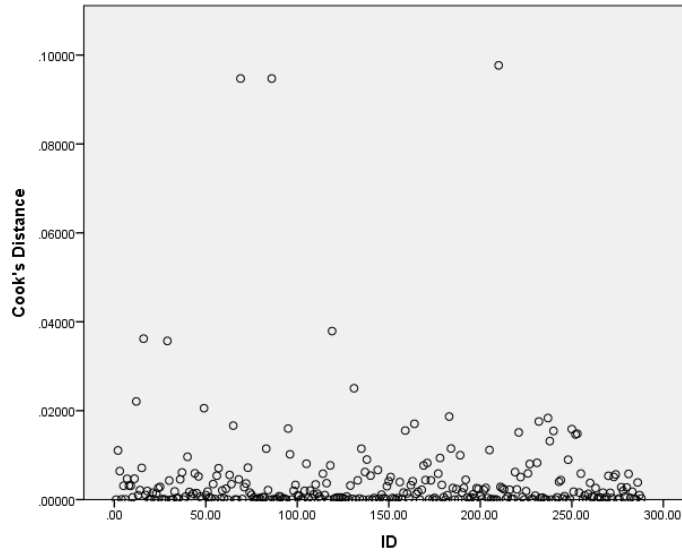

		Coefficients^a					Collinearity Statistics	
Model		Unstandardized		Standardized	t	Sig.	Tolerance	VIF
		B	Std. Error	Beta				
1	(Constant)	1.752	.314		5.571	.000		
	CE	.144	.064	.149	2.266	.024	.600	1.666
	EF	.110	.075	.098	1.470	.143	.589	1.698
	EJ	.324	.058	.352	5.571	.000	.650	1.539

a. Dependent Variable: IM

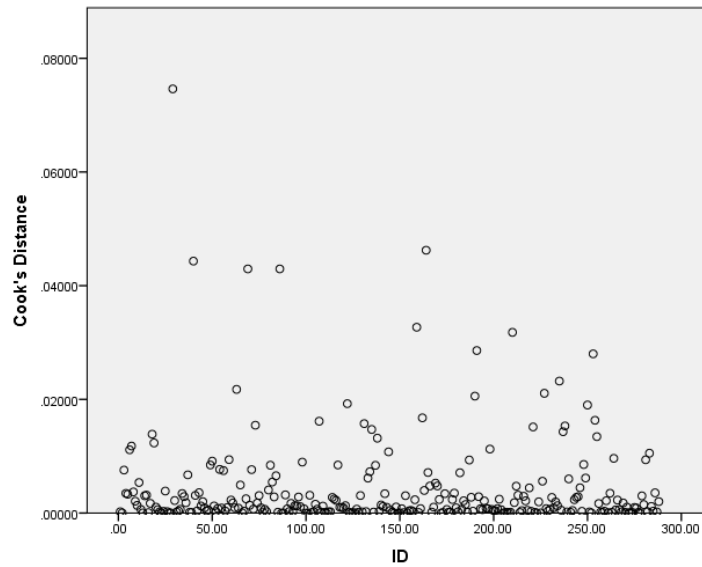

Coefficients^a

Model		Unstandardized Coefficients		Standardized Coefficients	t	Sig.	Collinearity Statistics	
		B	Std. Error	Beta			Tolerance	VIF
1	(Constant)	4.026	.409		9.847	.000		
	CE	.040	.079	.039	.510	.610	.589	1.697
	EF	-.060	.093	-.050	-.648	.518	.584	1.711
	EJ	-.080	.076	-.080	-1.052	.294	.586	1.707
	IM	.203	.073	.189	2.773	.006	.736	1.358

a. Dependent Variable: TM

Model Fit Summary

CMIN

Model	NPAR	CMIN	DF	P	CMIN/DF
Default model	37	183.501	83	.000	2.211
Saturated model	120	.000	0		
Independence model	15	2898.587	105	.000	27.606

RMR, GFI

Model	RMR	GFI	AGFI	PGFI
Default model	.183	.923	.888	.638
Saturated model	.000	1.000		
Independence model	.764	.316	.218	.276

Baseline Comparisons

Model	NFI Delta1	RFI rho1	IFI Delta2	TLI rho2	CFI
Default model	.937	.920	.964	.954	.964
Saturated model	1.000		1.000		1.000
Independence model	.000	.000	.000	.000	.000

Parsimony-Adjusted Measures

Model	PRATIO	PNFI	PCFI
Default model	.790	.740	.762
Saturated model	.000	.000	.000
Independence model	1.000	.000	.000

NCP

Model	NCP	LO 90	HI 90
Default model	100.501	65.110	143.629
Saturated model	.000	.000	.000
Independence model	2793.587	2621.685	2972.813

FMIN

Model	FMIN	F0	LO 90	HI 90
Default model	.639	.350	.227	.500
Saturated model	.000	.000	.000	.000
Independence model	10.100	9.734	9.135	10.358

RMSEA

Model	RMSEA	LO 90	HI 90	PCLOSE
Default model	.065	.052	.078	.027
Independence model	.304	.295	.314	.000

AIC

Model	AIC	BCC	BIC	CAIC
Default model	257.501	261.870	393.030	430.030
Saturated model	240.000	254.170	679.555	799.555
Independence model	2928.587	2930.359	2983.532	2998.532

ECVI

Model	ECVI	LO 90	HI 90	MECVI
Default model	.897	.774	1.047	.912
Saturated model	.836	.836	.836	.886
Independence model	10.204	9.605	10.829	10.210

HOELTER

Model	HOELTER .05	HOELTER .01
Default model	165	182
Independence model	13	15