

Development of a methodology for integrated performance analyses of anti-vibration gloves for controlling the hand-transmitted vibration

Yumeng Yao

A Thesis

In

The Department

of

Mechanical, Industrial and Aerospace Engineering

Presented in Partial Fulfillment of the Requirements

For the Degree of

Doctor of Philosophy (Mechanical Engineering) at

Concordia University

Montreal, Quebec, Canada

February 2020

© Yumeng Yao, 2020

**CONCORDIA UNIVERSITY
SCHOOL OF GRADUATE STUDIES**

This is to certify that the thesis prepared,

By: Yumeng Yao

Entitled: Development of a Methodology for Integrated Performance Analyses of
Anti-vibration Gloves for Controlling the Hand-transmitted Vibration

and submitted in partial fulfillment of the requirements for the Degree of

Doctor of Philosophy (Mechanical Engineering)

complies with the regulations of the University and meets the accepted standards with respect to originality and quality.

Signed by the final examining committee:

Dr. Anjali Awasthi	Chair
Dr. Tammy Eger	External Examiner
Dr. Ashutosh Bagchi	Examiner
Dr. Gerard Gouw	Examiner
Dr. Ramin Sedaghati	Examiner
Dr. Subhash Rakheja	Thesis Supervisor (s)
Dr. Pierre Marcotte	

Approved by: _____
Dr. Ali Dolatabadi Dean, Faculty of Engineering and Computer Science

09 April 2020
Date of Defense

Dr. Amir Asif Dean, Faculty of Engineering and Computer Science

ABSTRACT

Development of a methodology for integrated performance analyses of anti-vibration gloves for controlling the hand-transmitted vibration

Yumeng Yao, Ph.D.

Concordia University, 2020

Hand-transmitted vibration (HTV) arising from hand-held power tools has been associated with an array of disorders of the hand-arm system, collectively referred to as the hand-arm vibration syndrome (HAVS). The risk of HAVS among hand-held power tools operators has been related to the nature of HTV exposure and the mechanical coupling of the hand with a tool handle, which is neglected in the current standardized exposure assessment method (ISO 5349, 2001). Anti-vibration (AV) gloves are considered as convenient and effective means to reduce exposure to HTV. The effectiveness of AV gloves is, invariably, assessed on the basis of the handle vibration transmitted to the palm of the hand. The method does not consider the vibration responses of the fingers, which differ significantly from that of the palm. The AV gloves adversely influence the manual dexterity and grip strength of the operators, which are considered as primary factors discouraging the usage of AV gloves. The current standardized method, however, does not consider the loss of dexterity and grip strength caused by wearing these gloves.

This thesis proposes a methodology for evaluating the integrated performance of AV gloves, considering the distributed vibration transmission to the palm and fingers through gloves, manual dexterity and grip strength. In order to establish the methodology, independent experiments were designed to quantify each performance measure. Three series of experiments were designed to evaluate vibration responses distributed over the palm and fingers, manual dexterity and grip strength performance of gloves. Each experiment design involved ten different gloves and 15 adult male subjects. Viscoelastic properties of vibration isolation materials used in the AV gloves were also characterized under a constant preload. In the first series, the fine fingers and hand dexterity were investigated using the Two-Hand Turing & Placing Minnesota and ASTM F2010 methods. Subsequently, the handle vibration transmitted to the palm and mid phalanges of the index and middle fingers of the glove hand were measured along the three translational axes using the palm and fingers' adapters, respectively. In the final series, the influence of AV gloves on the operator's grip strength were investigated via direct as well as indirect methods. A flexible thin-film hand sensor was designed and verified for direct measurement of the contact force developed at the rigid

as well as flexible hand-handle, and hand-glove interfaces. The activities of four different forearm muscles were also measured via surface electromyography (EMG) under different hand grip forces imposed by the gloved hand.

The correlations among the individual performance measures of AV gloves and the material properties were analyzed via Pearson's correlation coefficient, which provided essential knowledge on the roles of design factors and the design guidance. A relationship among the hand grip, push and contact forces imposed on flexible hand-handle was developed via multiple linear regression analysis. The individual measures of AV gloves were also analyzed via two-factor repeated analyses of variance (ANOVA) and multivariate analysis of variance (MANOVA) to evaluate significance of different independent variables such as glove type, test method, frequency range, and hand grip force. The glove type yielded significant effect on all the measures ($p < 0.05$). Post-Hoc tests were subsequently conducted via Bonferroni and Tukey HSD (honest significant difference) test for discriminating difference among the gloves.

The combination of extensor carpi radialis longus (ECR) and flexor carpi radialis (FCR) muscles activities revealed highest sensitivity to discriminate among gloves and could serve as an effective indirect measure of the grip strength performance. Increasing the glove thickness resulted in improved vibration isolation by the glove but reduced manual dexterity and enhanced muscles activities. Strong correlation was observed between the material stiffness and w_h -weighted palm vibration transmissibility in the high frequency range ($r > 0.90$), while a weak correlation was evident between the manual dexterity and the w_p -weighted fingers' vibration transmissibility. Strong positive correlations were observed among the palm vibration isolation, material properties and material thickness in the 25-1250 Hz frequency range.

The results also revealed conflicting glove design requirements imposed by the individual measures. A methodology based on analytical hierarchy process (AHP) is proposed to identify weightings for the conflicting performance measures for the given work condition, classified in accordance with the frequency ranges of predominant vibration (low and high), as defined in ISO-10819 (2013) together with assembly/disassembly tasks. An integrated performance index is identified and applied to rank five different AV gloves with known individual performance measures for identifying the most desirable glove.

ACKNOWLEDGEMENT

The author wishes to express her sincere gratitude to her supervisors, Dr. Subhash Rakheja and Dr. Pierre Marcotte, for their professional guidance, continued patience and great supports through the thesis work. The author has been extremely lucky to have supervisors who cared so much about her work, and who responded to her questions and queries so promptly. Her endless thanks to them not only for offering her as many as great chances to cultivate her professional skills and critical thinking, but also for their charisma and demeanor imperceptibly influencing her personality.

The author also wishes to acknowledge Concordia University and CONCAVE center for their financial support, including the International Tuition Fee Remission, Mobility Award, Accelerator Award, Conference Award and Research Assistantship. Appreciation is also going to Dr. Christian Larivière and Ms. Gauvin Chantal from IRSST, Montreal, and Mr. Mayton Alan from NIOSH, Pittsburgh, for their assistance and suggestions during her study.

The author would like to thank her colleagues and great friends, Dr. Yuming Yin and Mr. Niranjana P Mehendale who truly supported her during all the tough time and experienced all of the ups and downs in Canada.

Finally, the author deeply thanks and appreciates her family who have always been there for all unconditional support and love. Thank you for being around, and never-ending motivations.

TABLE OF CONTENTS

LIST OF FIGURES	ix
LIST OF TABLES	xii
NOMENCLATURE	xiv
ACRONYMS	xvii
CHAPTER 1: LITERATURE REVIEW AND SCOPE OF THE DISSERTATION	- 1 -
1.1 Introduction	- 1 -
1.2 Literature review	- 2 -
<i>1.2.1 Characteristics of hand-transmitted vibration and its health effects</i>	- 2 -
<i>1.2.2 Control of hand-transmitted vibration</i>	- 6 -
<i>1.2.3 Performance analyses of AV gloves</i>	- 8 -
1.3 Scope and objective of the dissertation	- 16 -
1.4 Organization of the dissertation	- 17 -
CHAPTER 2: EVALUATION OF EFFECTS OF ANTI-VIBRATION GLOVES ON MANUAL DEXTERITY	- 22 -
2.1 Introduction	- 22 -
2.2 Materials and Methods	- 23 -
<i>2.2.1 Participants</i>	- 23 -
<i>2.2.2 Selection of dexterity test methods</i>	- 24 -
<i>2.2.3 Gloves</i>	- 25 -
<i>2.2.4 Measurements</i>	- 28 -
<i>2.2.5 Data analysis</i>	- 28 -
2.3 Results	- 30 -
<i>2.3.1 Completion time and manual dexterity</i>	- 30 -
<i>2.3.2 Number of drops</i>	- 34 -
2.4 Discussions	- 37 -
<i>2.4.1 Hand performance</i>	- 37 -
<i>2.4.2 Design guidelines for AV glove</i>	- 42 -
2.5 Conclusions	- 42 -
CHAPTER 3: RELATIONSHIP AMONG HAND FORCES IMPARTED ON AN VISCOELASTIC HAND-HANDLE INTERFACE	- 44 -
3.1 Introduction	- 44 -

3.2 Hand Sensor Design and Assessments	- 47 -
3.2.1 <i>Hand sensor calibration</i>	- 49 -
3.2.2 <i>Static characteristics of the hand sensor under global and local loading</i>	- 51 -
3.3 Measurements of the hand-handle contact force	- 53 -
3.3.1 <i>Data analysis</i>	- 56 -
3.4 Results and discussions	- 57 -
3.4.1 <i>Contact force developed at the rigid hand-handle interface</i>	- 57 -
3.4.2 <i>Contact force developed at the viscoelastic hand-handle interface</i>	- 60 -
3.4.3 <i>Contact force developed by the gloved hand</i>	- 62 -
3.5 Conclusions	- 64 -
CHAPTER 4: DISTRIBUTED VIBRATION ISOLATION AND MANUAL DEXTERITY OF ANTI-VIBRATION GLOVES: IS THERE A CORRELATION?	- 66 -
4.1 Introduction	- 66 -
4.2 Design of experiments	- 68 -
4.2.1 <i>Subjects and gloves</i>	- 68 -
4.2.2 <i>Measurements of vibration isolation performance of AV gloves</i>	- 69 -
4.2.3 <i>Characterizations of glove materials' properties</i>	- 71 -
4.2.4 <i>Data analysis</i>	- 72 -
4.3 Results	- 74 -
4.3.1 <i>Manual dexterity scores of AV gloves</i>	- 74 -
4.3.2 <i>Vibration transmissibility at the palm</i>	- 74 -
4.3.3 <i>Vibration transmissibility at the fingers</i>	- 80 -
4.3.4 <i>Properties of the glove materials</i>	- 85 -
4.3.5 <i>Correlations</i>	- 87 -
4.4 Discussions	- 91 -
4.4.1 <i>Vibration isolation and manual dexterity performance of AV gloves</i>	- 91 -
4.4.2 <i>Glove design guideline</i>	- 95 -
4.5 Conclusions	- 96 -
CHAPTER 5: MEASUREMENT OF FOREARM MUSCLE ACTIVITIES TO STUDY ANTI-VIBRATION GLOVES: SENSITIVITY AND CONSTRUCT VALIDITY ISSUES	- 98 -
5.1 Introduction	- 98 -
5.2 Experimental Methods	- 99 -
5.2.1 <i>Subjects and gloves</i>	- 99 -

5.2.2 EMG Assessments	- 100 -
5.2.3 Mechanical tests	- 102 -
5.2.4 Data processing and statistical analyses	- 102 -
5.3 Results	- 103 -
5.3.1 Sensitivity of the surface EMG methodology to AV gloves	- 103 -
5.3.2 Construct validity of the surface EMG methodology	- 108 -
5.4 Discussions	- 109 -
5.4.1 Sensitivity of the surface EMG methodology to AV gloves	- 110 -
5.4.2 Construct validity of the surface EMG methodology	- 110 -
5.4.3 Effect of AV gloves on forearm muscles' activities	- 111 -
5.5 Conclusions	- 112 -
CHAPTER 6: A METHODOLOGY FOR INTEGRATED PERFORMANCE ANALYSES OF ANTI-VIBRATION GLOVES	- 113 -
6.1 Introduction	- 113 -
6.2 Identification of weights of individual measures using analytical hierarchy process	- 114 -
6.2.1 Methodology	- 114 -
6.2.2 Formulations of pairwise comparison matrix	- 117 -
6.2.3 Data collection	- 121 -
6.3 Identification of weights and assessments of integrated performance	- 123 -
6.4 Discussions	- 125 -
6.5 Conclusions	- 128 -
CHAPTER 7: CONCLUSIONS AND RECOMMENDATIONS	- 130 -
7.1 Major contributions and highlights of the dissertation research	- 130 -
7.2 Major conclusions	- 130 -
7.3 Recommendations for future studies	- 132 -
Appendix: Statistical Analyses	- 134 -
A. Two-factor repeated-measures analysis of variance	- 134 -
B. Multiple linear regression analysis	- 140 -
C. Multivariate analysis of variance	- 142 -
References	- 146 -

LIST OF FIGURES

Figure 1. 1: Coordinate systems for the human hand-arm: — biodynamic; and ---- basicentric [19]	- 3 -
Figure 1. 2: Comparison of frequency weightings w_p and w_h [41].	- 5 -
Figure 1. 3: Technical route and framework of this dissertation.	- 17 -
Figure 2. 1: (a) Minnesota test apparatus; and (b) ASTM F2010 test apparatus.	- 25 -
Figure 2. 2: Box plots of completion time and manual dexterity score: (a) ASTM F2010 test completion time; (b) Minnesota test completion time; (c) ASTM F2010 test manual dexterity score; and (d) Minnesota test manual dexterity score	- 31 -
Figure 2. 3: Relationships between the glove thickness and manual dexterity score: (a) ASTM test; (b) Minnesota test.	- 33 -
Figure 2. 4: (a) Total number of drops observed for each glove type; and (b) rate of drop for each glove type	- 35 -
Figure 2. 5: Comparisons of mean dexterity scores of gloves obtained from ASTM and Minnesota tests, and mean of mean dexterity scores.	- 36 -
Figure 2. 6: Grouping of gloves based on mean manual dexterity score and Bonferroni tests: (a) ASTM test; and (b) Minnesota test (the gloves within the same group do not exhibit statistically significant difference among them).	- 37 -
Figure 3. 1: (a) Dimensions of the sensing grids in the fingers and palm regions; and (b) pictorial view of the hand-sensor.	- 49 -
Figure 3. 2: Loading of the hand sensor through an aluminum plate and elastomer.	- 52 -
Figure 3. 3: Variations in measured force with the applied force during three loading and unloading cycles.	- 52 -
Figure 3. 4: Pictorial views of the measurement setup: a) hand sensor fixed to the hand; b) subject's posture while grasping the handle; c) handle covered with a gel material; d) gloved hand with the hand sensor;	- 55 -
Figure 3. 5: Instrumented cylindrical handle with grip and push force sensors	- 55 -
Figure 3. 6: Variations in the mean contact force measured on the 40 mm rigid hand-handle interface with: (a) hand grip force; and (b) hand push force.	- 58 -
Figure 3. 7: Variations in the mean contact force measured on the elastic hand-handle interface (FH) with: (a) hand grip force; and (b) hand push force.	- 61 -

Figure 3. 8: Comparisons of mean contact area attained for the rigid (RH), viscoelastic (FH) and gloved (GV) hand-handle interface conditions as a function of hand push and grip forces combinations.	- 62 -
Figure 3. 9: Variations in the mean contact force measured at the glove-hand interface (GV) with: (a) hand grip force; and (b) hand push force.	- 63 -
Figure 3. 10: Variations in the contact force with the coupling force obtained for rigid (RH) and viscoelastic contact conditions (FH, GV)	- 64 -
Figure 4. 1: (a) Experimental setup; (b) Palm adapter; and (c) Velcro finger adapters [5]	- 70 -
Figure 4. 2: Schematic diagram of the laboratory setup for characterizing glove material properties	- 72 -
Figure 4. 3: Comparisons of mean palm vibration transmissibility of subjects with different gloves.	- 77 -
Figure 4. 4: Comparisons of overall w_h -weighted palm vibration transmissibility (TR) of different gloves in the M- and H-frequency ranges and the screening criteria defined in the ISO 10819 [11].	- 79 -
Figure 4. 5: Comparisons of mean index finger vibration transmissibility of different subjects with different AV gloves	- 81 -
Figure 4. 6: Comparisons of mean middle finger vibration transmissibility of different subjects with different AV gloves	- 82 -
Figure 4. 7: Comparisons of mean vibration transmissibility characteristics of the gloved index and middle fingers normalized with respect to those of the bare hand.	- 83 -
Figure 4. 8: (a) force-displacement; and (b) force-velocity characteristics of the <i>gel2</i> glove material under quasi-static and harmonic excitations.	- 86 -
Figure 4. 9: Correlation between the glove material stiffness and the frequency weighted vibration transmissibility of the: (a) palm; (b) index finger; and (c) middle finger in the M- (left column) and H- (right column) frequency ranges.	- 88 -
Figure 4. 10: Correlation between the glove material damping coefficient and the frequency weighted vibration transmissibility of the: (a) palm; (b) index finger; and (c) middle finger in the M- (left column) and H- (right column) frequency ranges.	- 89 -

Figure 4. 11: Correlation between the glove thickness and the frequency weighted vibration transmissibility of the: (a) palm; (b) index finger; (c) middle finger in the M- (left column) and H- (right column) frequency ranges.	- 90 -
Figure 4. 12: Relationships between glove thickness and manual dexterity for ASTM F2010 test.	- 90 -
Figure 5. 1: The gloves used in this study	- 99 -
Figure 5. 2: Experimental setup and subject's posture.	- 102 -
Figure 5. 3: Mean normalized activities of ECR, FCR, ECR_FCR and the mean of the four muscles (X-all) obtained for each glove and two levels of grip force (25 N and 50 N).	- 106 -
Figure 5. 4: Correlation coefficient (r) between the normalized activities of ECR_FCR muscles and: (a) glove material thickness; (b) dexterity score.	- 109 -
Figure 6. 1: A hierarchical structure for identifying a near optimal alternative	- 115 -
Figure 6. 2: Acceleration power spectral density (PSD) of the standardized [11] and considered tools' vibration [80].	- 118 -
Figure A: Schematic representation of the analysis: (a) Partition of the total variation for repeated measures; (b) Partition of degrees of freedom	- 137 -

LIST OF TABLES

Table 2. 1: Hand and selected anthropometric dimensions of participants	- 24 -
Table 2. 2: Brief descriptions of the vibration isolation materials and glove coverings	- 27 -
Table 2. 3: Results obtained from Bonferroni test to identify statistical differences between the gloves (ASTM F2010 test)	- 32 -
Table 2. 4: Results obtained from Bonferroni test to identify statistical differences between the gloves (Minnesota test)	- 32 -
Table 2. 5: Pearson’s correlation coefficients of manual dexterity with glove thickness and hand dimensions for the two test methods	- 34 -
Table 2. 6: Pearson’s correlation coefficients between number of drops and glove thickness, hand size and manual dexterity for each test	- 35 -
Table 3. 1: Comparison of mean measured and applied force magnitudes	- 51 -
Table 3. 2: Variability in the measurement under locally applied loads	- 53 -
Table 3. 3: Grip and push force coefficients obtained from multiple linear regression analysis of the data for five subjects and different hand-handle interface conditions.	- 59 -
Table 4. 1: Undeformed thickness and dexterity scores of the gloves measured using ASTM and Minnesota test methods	- 69 -
Table 4. 2: Mean normalized unweighted and frequency-weighted palm and fingers vibration transmissibility of the test gloves in the M-and H-frequency ranges.	- 76 -
Table 4. 3: Mean peak vibration transmissibility magnitudes and corresponding frequency obtained at the palm, and index and middle fingers for the bare hand and gloved hand in the M- and H- frequency ranges.	- 78 -
Table 4. 4: p -values obtained from two-way MANOVA for the effects of different factors on the w_h -weighted vibration transmissibility at the palm and fingers	- 79 -
Table 4. 5: Equivalent stiffness and damping coefficients of the glove materials	- 87 -
Table 4. 6: Correlations among the glove material properties, thickness, dexterity and vibration and H-range palm and fingers vibration transmissibility	- 91 -
Table 5. 1: Hand dimensions of the participants	- 100 -
Table 5. 2: Mean, standard deviation (SD) and coefficient of variation (CoV) of normalized forearm muscles activities (X-all) and mean dexterity score of 15 subjects for each glove, and properties of gloves	- 104 -

Table 5. 3: Two-way rANOVA results obtained for four individual muscles, and ECR_FCR and the mean of four muscles (X-all).	- 105 -
Table 5. 4: One-way rANOVA results obtained for four individual muscles, and ECR_FCR and the mean of four muscles (X-all) for two levels of grip.	- 107 -
Table 6. 1: The 1-9 point scale used for pairwise comparisons of the elements in an AHP [199].	- 116 -
Table 6. 2: Pairwise comparison matrix for tools with dominant vibration in the higher frequency range	- 119 -
Table 6. 3: Pairwise comparison matrix for tools with dominant vibration in the lower frequency range	- 120 -
Table 6. 4: Pairwise comparison matrix when operators are required to perform assembly/disassembly tasks in addition to low frequency tools	- 121 -
Table 6. 5: Mean measures of individual performance measures of five gloves considered as possible alternatives together with material thickness, index finger width and equivalent stiffness/damping properties	- 123 -
Table 6. 6: Consistency ratio and weights for different measures for three work conditions	- 124 -
Table 6. 7: Integrated performance indices and ranking of AV gloves for three work conditions	- 125 -
Table A. 1: Basic data for the multivariate analysis of variance, $p = 3$	- 143 -

NOMENCLATURE

a_{hi}	root mean square acceleration measured in the i^{th} one-third-octave band
a_{hv}	vector sum of frequency-weighted RMS acceleration values
a_{hw}	frequency-weighted acceleration
a_{hwx}	frequency-weighted RMS acceleration along the x-axis
a_{hwy}	frequency-weighted RMS acceleration along the y-axis
a_{hwz}	frequency-weighted RMS acceleration along the z-axis
a_{ij}	element of the pairwise comparison matrix ($j = 1, 2, \dots, n; i = 1, 2, \dots, n$)
A	pairwise comparison square matrix
A_c	total effective hand-handle contact area
$A(8)$	8-h energy-equivalent frequency-weighted vibration total exposure
$A(f_i)$	resultant acceleration in the band with center frequency f_i
$\overline{A(f_i)}$	mean values of total acceleration values of palm/fingers at center frequency f_i
$A_x(f_i)$	vector sum acceleration at center frequency f_i along x-axis
$A_y(f_i)$	vector sum acceleration at center frequency f_i along y-axis
$A_z(f_i)$	vector sum acceleration at center frequency f_i along z-axis
ΔA	individual sensel area
CI	consistency index
CR	consistency ratio
C_{eq}	equivalent viscous damping coefficient
Corrected_TR	normalized vibration transmissibility
d	Cohen's values
D	manual dexterity score
ΔE	energy dissipated
F_g	grip force
F_p	push force
F_c	contact force
H_0	null hypothesis
H_1	alternative hypothesis
$H(f_i)$	vibration measured at handle in the band centered at f_i

$\overline{H(f_i)}$	mean values of total acceleration value of handle at center frequency f_i
I_H	performance index for high frequency vibration
I_L	performance index for low frequency vibration
I_A	performance index for assembly/disassembly tasks in addition to vibration
K_{eq}	equivalent stiffness
L	lower limit of the frequency band
MA	muscles' activity
MS	mean sum of squares
MSE	mean square error
n	number of active sensels or number of comparative elements
N	number of significant differences
$NRMS_i$	normalized activity of muscle i ($i=1,\dots,4$)
p	statistical significance
p_i	pressure measured by the sensel i
q	number of subgroup of an independent variable
$q_{A,a}$	q statistics for factor A at a level
Q	Studentized statistical distribution
r	Pearson correlation coefficient
R^2	coefficient of determination
RMS_{GV}	EMG activation obtained with the gloved hand
RMS_{BH}	EMG activation obtained with the bare hand
RI	random index
S	group size
SS_T	total sum of squares
SS_b	between-groups variance
$SS_{subjects}$	subject variance
SS_{error}	error variance
T	total daily exposure duration
T_0	reference duration of 8 h
$TR(f_i)$	vibration transmissibility at center frequency f_i

$TR_{W(glove)}$	frequency-weighted palm or fingers' vibration transmissibility
TR_{palm}	vibration transmissibility at palm
$TR_{fingers}$	vibration transmissibility at fingers
U	upper limit of the frequency band
w_h	standardized frequency-weighting [1]
w_{hi}	weighting factor for the i th one-third-octave band ($i=1, \dots, N_s$)
w_p	fingers vibration frequency weighting
X	displacement amplitude or predictor variable
Y	outcome variable
z_h	along the forearm direction
α_0	contact force offset
α_g	grip force coefficients
α_p	push force coefficients
λ_{max}	principle eigenvalue
ω	principal eigenvector
δ^2	Variance

ACRONYMS

AHP	Analytical hierarchy process
ANOVA	Analysis of variance
ASTM	ASTM F2010
AV	Anti-vibration
CoV	Coefficient of variation
DAQ	Data acquisition system
ECR	Extensor carpi radialis longus
ECR_FCR	Combination of extensor carpi radialis longus and flexor carpi radialis
ED	Extensor digitorum
EMG	Electromyography
FCR	Flexor carpi radialis
FDS	Flexor digitorum superficialis
FH	Hand grasping the instrumented flexible handle
GV	Gloved hand
H	High frequency range
HAS	Hand-arm system
HAVS	Hand-arm vibration syndrome
HSD	Honest significant difference
HTV	Hand-transmitted vibration
M	Medium frequency range
MANOVA	Multiple analysis of variance
MCDM	Multiple criteria decision making
Minnesota	Two-hand turning & placing Minnesota test
MVC	Maximum voluntary contraction
PCM	Pairwise comparison matrix
PUF	Polyurethane
PSD	Power spectral density

rANOVA	Repeated analysis of variance
RH	Bare hand grasping an instrumented rigid handle
RMS	Root mean square
RMS _{BH}	RMS values obtained with bare hand
SD	Standard deviation
TR	Vibration transmissibility
TR_finger	Vibration transmissibility at finger
TR_palm	Vibration transmissibility at palm
VPA	Vibration power absorption
VWF	Vibration-induced white finger
X-all	Mean of all four muscles

CHAPTER 1: LITERATURE REVIEW AND SCOPE OF THE DISSERTATION

1.1 Introduction

Continued exposure to hand-transmitted vibration arising from hand-held power tools, such as chipping hammers, rock drills, riveters and bucking bars, has been associated with an array of disorders of the hand-arm system (HAS). Anti-vibration gloves made of air bladder or viscoelastic gels have evolved to help reduce the vibration transmitted to the hands of the power tool operators. However, wearing these gloves adversely affects operators' grip strength and manual dexterity [2, 3]. The operators may thus be reluctant to wear such gloves, especially while working with hand-held power tools in conjunction with other manual tasks. Designs of AV gloves with adequate dexterity and vibration attenuation are thus vital for promoting their usage. A study on the effect of AV gloves on both the distributed vibration isolation performance and the correlations among the vibration reduction, manual dexterity and grip strength performances of AV gloves may provide essential guidance for glove designs and for selection of near optimal AV gloves for different work conditions.

The vibration reduction performance of AV gloves is known to depend on the dominant vibration frequencies and vibration direction [4-6], and glove material properties (thickness, stiffness and damping) [7, 8], in addition to the hand forces and the contact area [9, 10]. The evaluations of effectiveness of AV gloves on the hand-transmitted vibration has been extensively studied using the standardized method defined in ISO 10819 [11], which only considers the glove vibration transmissibility at the palm, while the fingers' vibration responses of AV gloves are either ignored or assumed similar to those of the palm. McDowell et al. [4] have characterized the vibration transmissibility of AV gloves at the palm in three orthogonal directions, and concluded that the AV gloves are most effective in reducing the palm-transmitted vibration only along the forearm direction. Laszlo and Griffin [10] reported that the transmissibility characteristics of the AV gloves were not greatly affected by the vibration magnitude but highly dependent on the push force. Another study suggested relatively small effects of hand grip and push forces on the palm vibration transmissibility of AV gloves [12]. The fingers' vibration performance of AV gloves has been evaluated in only a few studies, which have invariably wide differences between the palm and fingers vibration transmissibility characteristics [3, 6, 13]. These have shown that AV gloves attenuate handle vibration transmitted to the fingers at frequencies above 400 Hz and amplify

fingers vibration in 100-400 Hz frequency range. The gloves considered in these studies also showed superior attenuation of vibration transmitted to the palm, especially at higher frequencies. While the above-mentioned studies have shown comparable trends fingers vibration transmission performance of AV gloves, notable differences could be observed with regard to the magnitudes and dominant frequencies of transmitted vibration. These are likely due to different measurement methods and AV gloves used in the studies.

In addition, the standardized evaluation method [11] does not consider the manual dexterity and grip strength performance of AV gloves. A few studies reporting dexterity performance of protective gloves have shown that the manual dexterity decreases with increase in the glove thickness at the fingers [14, 15]. The grip strength, represented by the total contact force at the hand-handle interface, has been evaluated using a cylindrical instrumented handle with force/pressure sensors or electromyography [3, 16-18]. The results showed that AV gloves decrease hand grip strength. The operators thus require a higher grip effort with gloved hand. Even though some work has been carried out to investigate the individual performance of AV gloves, no attempt has been made to develop a methodology to evaluate the integrated performance of AV gloves. Moreover, a performance index has not been proposed to help operators to select near optimal AV gloves based on different work conditions.

This dissertation research is aimed at developing a method for the assessment of integrated performance of AV gloves in terms of vibration transmissibility at the palm and fingers, the manual dexterity and grip strength performance. The manual dexterity, vibration transmissibility and muscle activities performance of AV gloves were comprehensively analyzed to propose an index for selection of near optimal AV gloves according to different work conditions.

1.2 Literature review

The state-of-the-art developments in characteristics of hand-transmitted vibration and vibration control, and performance analyses of AV gloves are reviewed in order to build essential knowledge on integrated analysis and design methods as well as research challenges to formulate the scope of the dissertation research. The reported studies grouped under relevant subjects are briefly discussed in the following subsections.

1.2.1 Characteristics of hand-transmitted vibration and its health effects

Hand-transmitted vibration (HTV) is generally expressed in terms of acceleration due to vibration at the hand-tool interface, as recommended in ISO 5349-1 [19]. Apart from convenience of its

measurement, the acceleration directly relates to the force or stress in the hand-arm system, and is believed to have strong positive correlation with the potential physical damage caused by HTV [20]. The measured acceleration at the hand-handle interface is considered as a sufficient representation of the vibration exposure when it describes all the essential features (magnitude, frequency range and direction of dominant vibration). Considering the complexities associated with the structure and material properties of the hand-arm system (HAS), the vast majority of the studies have characterized the nature of HTV along the three translational axes, while neglecting the effects of rotational motions. The measurements of translation vibration are performed using the basicentric coordinate systems, defined in ISO 5349-1 [19], and shown in Figure 1.1. The magnitudes of hand-transmitted vibration are expressed as the root mean square (RMS) values of an average measure of the handle acceleration.

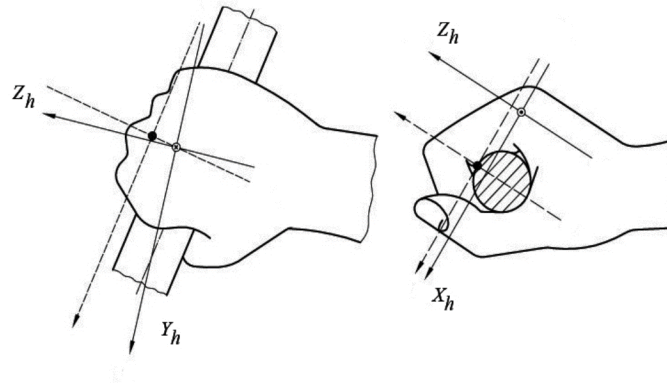

Figure 1. 1: Coordinate systems for the human hand-arm: — biodynamic; and ----- basicentric [19]

The magnitude and frequency of HTV are affected by many extrinsic and intrinsic factors in a highly complex manner. These include coupling forces, grip type, contact force distribution, handle geometry, hand posture, and other inter-individual operator characteristics [21, 22]. The nature of HTV due to different hand-held power tools have been widely characterized through measurements, which have shown widely varying magnitudes and frequency ranges of HTV [20, 23, 24], and large magnitude dynamic forces and torques [25, 26]. Studies reporting measured vibration of different tools show notable handle vibration in the 20 Hz to 1250 Hz with acceleration magnitudes ranging from 10 m/s² to 2014 m/s² [21, 22]. The directions of dominant vibration also tend to differ for different tools. The dominant frequencies of vibration of various tools lie in the 25 to 320 Hz range, which are mostly associated with operating speed of the tool [27].

The severity of vibration on the responses of HAS varies among different frequencies. The evaluations of the human hand-arm exposure to HTV are invariably obtained using frequency weighting w_h defined in the ISO 5349 standard [19], which reflects the assumed importance of different frequencies in causing injuries to the hand. It is also assumed that vibration in each of the three directions, in Figure 1.1, is equally detrimental, and that the same frequency weighting may be used for each axis. The frequency-weighted acceleration a_{hw} obtained from:

$$a_{hw} = \sqrt{\sum_i (w_{hi} a_{hi})^2} \quad (1.1)$$

where w_{hi} is the weighting factor for the i^{th} one-third-octave band, and a_{hi} is the root mean square acceleration measured in the i^{th} one-third-octave frequency band. The one-third-octave band frequencies in the 6.3 Hz to 1250 Hz range constitute the primary frequency range of HTV exposure.

Considering the dominance of vibration along multiple axes, the vibration total exposure a_{hv} is evaluated considering the vector sum of frequency-weighted RMS acceleration values a_{hwx} , a_{hwy} and a_{hwz} , along the x-, y- and z-axes, respectively, such that:

$$a_{hv} = \sqrt{a_{hwx}^2 + a_{hwy}^2 + a_{hwz}^2} \quad (1.2)$$

where a_{hwj} ($j = x, y, z$) defines the frequency weighted acceleration along the j^{th} axis. The vibration total exposure a_{hv} is dependent on the magnitude of vibration and on the duration of the exposure. Daily exposure duration is the total time for which the hand(s) is (are) exposed to vibration during the working day, which is derived from the vibration total exposure and the daily exposure duration.

$$A(8) = a_{hv} \sqrt{\frac{T}{T_0}} \quad (1.3)$$

where $A(8)$ is the 8-h energy-equivalent frequency-weighted vibration total exposure and T is the total daily duration of exposure to the vibration total exposure a_{hv} . T_0 is the reference duration of 8 h. The daily vibration exposure, $A(8)$, is estimated to provide the probable safe exposure duration in terms of number of years likely to produce finger blanching in 10% of the exposed populations. The European Directive 2002/44/EC3 [28] defines the exposure limit, in terms of $A(8)$, of 5 m/s². The directive also defines the daily exposure action value of 2.5 m/s².

Laboratory methods for measurements of HTV of different hand-held power tools have been described in ISO 5349-2 (2001) [1]. A number of limitations of the recommended methods, exposure limits and the frequency-weightings, however, have been described in the reported studies [29-32]. The standardized frequency-weighting, w_h , indicates substantial attenuation of high

frequency vibration and thereby may underestimate the exposure and effects of percussion tools vibration, as shown in Figure 1.2. A few studies have proposed alternate frequency-weightings for assessing the health risks of HTV [13, 33-37]. Dong et al. [38] proposed weightings for the fingers and palm-wrist arm structure on the basis of distributed vibration power absorption (VPA) properties of the HAS. The weighting obtained from the VPA distributed in the palm-wrist and arm correlated well with standardized w_h weighting, while the VPA-based weighting for the fingers was comparable with unweighted acceleration. The study suggested that the standardized frequency weighting is more suited for assessing risks of developing disorders in the palm-wrist-arm substructures. It may overestimate the low frequency effects but greatly underestimate the high-frequency vibration effects, which are believed to affect the development of fingers' disorders. Alternative weightings [35, 39-41] were proposed to quantify the risk of developing symptoms of VWF from the exposure of the fingers to vibration, which are based on the findings of either epidemiological studies of vibration-exposed workers or biodynamic investigations of vibration power absorption in the fingers. The w_p weighting, reported in the Annex of the current standard [41] is compatible with the results of many reported studies and provides the best estimate of the frequency weighting required to quantify the risk of developing symptoms of vibration white finger caused by exposure of the hands to vibration [41]. Figure 1.2 compares the w_p -weighting with the w_h -weighting

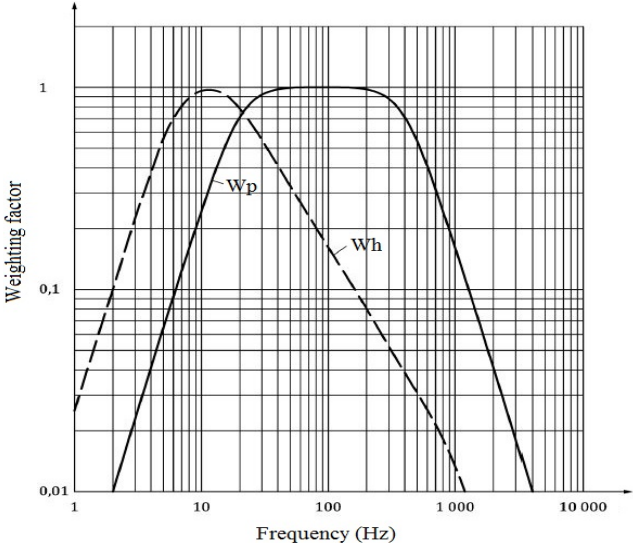

Figure 1. 2: Comparison of frequency weightings w_p and w_h [41].

Health Effects: Operators of hand-held power tools are subject to sustained levels of forces generated by the tools and vibration transmitted from the tool handle to the HAS [42]. The vibration

results in adverse influences on the muscles exertion and may induce constrictions of the blood vessels in the hands and arms, which may lead to the HAVS. The amount of damage to the blood vessels is related to intensity of vibration and exposure duration [43-45]. HAVS may involve either separately or in combination of the following four effects:

- a. Peripheral neural effects: The early symptoms include tingling and/or numbness of the fingers with or without pain. With continued exposure, the attacks may become more frequent and the symptoms more severe leading to decreased manual dexterity and grip strength [46, 47].
- b. Peripheral vascular effects: The earliest signs being the episodic attacks of fingertip blanching, the frequency and severity of the episodes of white finger increase with continued exposure, and the finger blanching may occur even in the warm climates [48-50].
- c. Muscles effects: The symptoms of reduced grip and muscles strengths have been reported among 28% of chain saw operators in Japan with more than 2000 hours of chain saw usage [51]. A Finnish study reported similar symptoms among 20% of chain saw operators with more than 5000 hours of chain saw usage [52, 53].
- d. Bones and joints effects: Degenerative changes in the bones of the fingers and wrists have been reported among the workers using hand-held power tools. The changes observed were mainly cysts, vacuoles, and areas of decalcification [44, 54].

The related knowledge of HAVS is based mainly on retrospective epidemiologic studies or clinical examinations, and comparisons of workers who use and do not use vibration tools, and who do or do not have symptoms of HAVS [26, 55-57]. The lack of objective data from controlled laboratory investigations raises concerns on validity of any dose-response or risk factor predictions.

1.2.2 Control of hand-transmitted vibration

Owing to observed relationships between the nature of HTV and probable have risks, considerable efforts have been made to limit the magnitudes of HTV. The control of vibration has been attempted using two approaches involving isolation of the hand from the tool via vibration isolation materials, such as anti-vibration gloves [3, 58], and isolation of handle from the tool via handle isolators [59, 60]. Apart from these, a number of low-vibration tools have also evolved. Compact tool designs, however, pose considerable challenges in integrating vibration isolation system within the tool. Sokolov et al. [61] focused on the synthesis of the structure of percussion machines within low emission of hazardous vibration. The simplest three-body system was designed for a percussion machine, which could yield a strong vibro-impact process with a handle being free of vibration.

However, this design is less convenient to handle and with limited application when compared with common hand-held and mounted percussion machines, which contact the ground only at the demolition points. It also required relatively higher feed force from the operator compared to the conventional machines [61]. A reduction in the harmful vibration can also be achieved by a vibration isolator, which can be considered as a resilient member, placed between the source of vibration and the protected body. Sam and Kathirvel [62] developed four rubber engine mountings and a handle isolator of hand tractor to reduce the vibration transmitted to the hands. The vibration was measured to quantify the reduction in vibration in three operations namely, rota-tilling in an untilled field, rota-puddling in a field with 5 cm standing water and transportation on a tarmac road. The results showed that rubber mountings with higher stiffness and damping properties are effective in reducing low frequency (1-30 Hz) and larger amplitude (> 0.3 mm) vibration. The vibration reduction performance of different isolators varies with different operation speeds and work conditions. One of the rubber mountings amplified vibration in the range of 0.7% to 43.2%, irrespective of work conditions. The combined effect of engine mounting and handle isolator reduced the frequency-unweighted and frequency-weighted vibration acceleration (rms) by 50.9% and 29.8%, respectively.

In order to limit the energy absorbed into the hand, the dynamic vibration absorbers have been proposed to distribute the energy from hand to the upper-arm structure [63, 64]. Strydom et al. [63] investigated the feasibility of using a tuned vibration absorber to reduce the vibration from the rock drills. An attenuator system based on a mathematical model of a liquid inertia absorber was designed and tested. The results indicated that transmissibility could be reduced to between 20% and 40% of the non-attenuated rock drill handle. However, the numerous practical problems should be solved, such as the compact packaging of the absorber, ensuring acceptable robustness and dealing with moments caused by lateral forces applied to the handle. Hao et al. [64] proposed a tuned vibration absorber for the suppression of hand-arm vibration in an electric grass trimmer and identified an optimal absorb location both analytical and experimentally. The tuned vibration absorber was attached to the optimal location of the shaft of electric grass trimmer, which was found to have best performance with 95% reduction on the acceleration level in the X_h axis. Cherian et al. [65] proposed a concept of an energy flow divider. The study proposed a six degree of freedom biomechanical model of the HAS with energy divider to study the vibration transmissibility characteristics of the HAS. Compared to the response characteristics of the HAS, the coupled hand-

arm-divider model demonstrated a superior performance of the energy flow divider in limiting the vibration transmitted to the HAS. Lindell [66] redesigned a hand-held pneumatic impact tool to reduce the vibration level and thereby the risk of injuries to operators. The vibration reduction was achieved by a tuned vibration absorber and isolation of vibration between the impact mechanisms and the housing to which the handles are attached. The results indicated that the redesigned machine reduced the vibration by 87%, compared to the original machine, from 20.2 to 2.7 m/s². A disadvantage of the conventional tuned mass absorber is that in order to get the isolation frequency down to the typical operating frequencies of hand-held power tools, the isolation mass has to be large or the stiffness very low.

While the abovementioned designs of low vibration power tools and handle isolators have evolved, anti-vibration (AV) gloves are considered as convenient means to attenuate vibration transmitted to the HAS. A large number of studies have investigated effectiveness of AV gloves either in the field or in the laboratory [3, 12, 58, 67-70]. The results invariably showed notable vibration attenuation performance of gloves at the palm, especially in the high frequency ranges, and either limited attenuation or amplification of vibration transmitted to the fingers [6, 7, 71, 72] due to their very low apparent mass. The designs of AV gloves, however, involve complex compromises among vibration isolation, and preservations of manual dexterity and hand strength [2, 3, 16].

1.2.3 Performance analyses of AV gloves

AV gloves made of air bladder or resilient materials are considered as an efficient and convenient way to attenuate exposure to HTV, apart from protection from cuts and chemicals. Considerable efforts have been made to develop methods for assessing vibration attenuation effectiveness of gloves over the past two decades [68, 73], which have culminated into designs of effective anti-vibration gloves with *air*, *gel* and *hybrid* combinations of different viscoelastic materials [74]. These have shown that AV gloves can reduce tool handle vibration transmitted to the palm of the hand from 5% to 20%, depending on the specific tool [58]. Another recent study has shown even greater reduction in HTV by the AV gloves [3]. The evaluations of effectiveness of AV gloves are concluded using two methods, which include the traditional transmissibility measurement using a palm adapter recommended in ISO 10819 [11] and the biodynamic responses method [68, 69]. Dong et al. [68] proposed a method by using biodynamic responses of the bare- and gloved-hand-arm system to evaluate the effectiveness of anti-vibration gloves. The proposed method was

validated by comparing the vibration transmissibility of the glove estimated from apparent mass measured with five human subjects with that obtained using the palm adapter method. The method could thus eliminate the coupling effect of the adapter. Moreover, a number of hand-arm models have been proposed for developments in mechanical-equivalent analogs for effective assessments of HTV exposure and vibration isolation systems [22, 75, 76]. It has been suggested that applications of models could eliminate large variability in responses and permit efficient assessments of exposure and vibration isolation mechanisms [77].

The effectiveness of the AV gloves on the hand-transmitted vibration has been widely assessed using the standardized method defined in ISO 10819 [11]. This standard specifies the vibration transmissibility in terms of vibration transmitted from a handle through a glove to the palm of the hand in one-third-octave frequency bands, ranging from 25 Hz to 1250 Hz. Five subjects are required to perform the glove vibration transmissibility test using the recommended measurement setup. A vibration exciter is used to generate the band-limited random vibration signal. The handle (40 mm diameter and 140 mm long) mounted on the vibration exciter is instrumented with a tri-axial accelerometer and two single-axis force sensors to measure the handle acceleration and the grip force, respectively. The push force imposed on the handle is measured using a force plate or a set of force sensors mounted between the handle and the vibration exciter. A palm adapter equipped with a tri-axis accelerometer is placed between the palm and glove, while applying 30 N grip and 50 N push forces to the instrumented handle. The standardized methodology requires the evaluation of glove vibration isolation effectiveness in the medium (M: 25-200 Hz) and high (H: 200-1250 Hz) frequency ranges. The frequency-weighted acceleration (rms) measured at the handle and the palm held adapter are computed using the w_h -weighting function defined in ISO 5349-1 [19]. To compensate for the frequency response of the palm adaptor, the glove vibration transmissibility is calculated as the ratio of the w_h weighted vibration transmissibility values at the palm of the hand with a glove divided by the corresponding w_h weighted transmissibility values associated with the bare palm adaptor attached to the handle. The ISO 10819 [11] states that a glove could be considered as an AV glove, provided: 1) the w_h -weighted palm acceleration transmissibility values in the M- and H- frequency ranges do not exceed 0.9 and 0.6, respectively; 2) the thickness of the vibration-reducing material placed in the palm should not be greater than 8 mm, while the glove thickness of vibration-reducing material placed in the fingers should be equal

to or greater than 0.55 times the glove thickness on the palm section; and 3) the same vibration-reducing material shall be placed in the palm and fingers sections of the glove.

Although many studies have investigated the effectiveness of the vibration isolation performance of AV gloves using the standardized method, some limitations exist. Firstly, the recommended assessment method is solely based on the vibration transmitted to the palm of the hand and ignored the fingers vibration responses, although it has been shown that the transmission to the fingers could be very different from that at the palm of the hand. Welcome et al. [6] used a 3-D laser vibrometer to measure the vibrations on the fingers of the hand with and without a glove. The results showed that the finger vibration depends on the AV glove type, and the distribution of the finger contact stiffness and the grip effort. The gloves increased the vibration in the fingertip area but marginally reduced the vibration in the proximal area at some frequencies below 100 Hz. The reduction in vibration transmitted to the fingers was less than 3% at frequencies below 80 Hz, while the amplification of vibration was considerable in the 80 to 400 Hz frequency range. Almagirby et al. [78] developed a bespoke lab-based apparatus to measure and evaluate vibration transmitted to the index finger in contact with three different AV materials under controlled hand grip force. The results showed notable attenuation of fingers vibration at frequencies above 315 Hz to 400 Hz for all the three materials. Velcro-mounted miniature accelerometers were used in [3, 5] for measuring vibration transmitted to mid-phalanx of the middle and index fingers. The studies showed fingers vibration performance of gloves comparable to those reported in [6]. Dong et al. [79] proposed a methodology for predicting vibration transmissibility of major substructures of the hand-arm system, including the fingers.

Secondly, the palm adapter used to evaluate the vibration isolation effectiveness of the AV gloves may alter the glove-hand coupling and result in overestimations of effectiveness of the gloves. Thirdly, this standard does not take into account the loss of dexterity and grip strength caused by wearing these gloves, although in practice these ergonomic aspects may limit the wearing of gloves by the workers. Fourthly, the vibration isolation effectiveness of AV gloves is tool-specific considering wide variations in the magnitudes and frequency ranges of vibration of different tools. Rakheja et al. [80] compared different tools vibration spectra with the standardized frequency spectrum recommended for the glove test. The study concluded that the standardized spectrum does not characterize the vibration characteristics of most of the tools considered.

Consequently, the vibration isolation effectiveness of a glove for specific tools cannot be evaluated using the standardized criteria in the M- and H-frequency ranges.

1.2.1 Manual dexterity performance of gloves

Compared to the conventional protective gloves, the AV gloves integrating one or more layers of vibration isolation materials are generally bulky and thick. Owing to their bulky design, the AV gloves may adversely affect the manual dexterity and job precision, which have not yet been reported to the best of knowledge of the author. The operators may thus be reluctant to use such gloves, while working with vibrating tools, especially in conjunction with other manual tasks. This may expose them to different accident risks. In a study of an automobile plant workers, Akbar-Khanzadeh et al. [81] reported discomfort among 58% of workers wearing the protective gloves. It has been further reported that 81% of workers involved in mechanical trauma, chemical agents and extreme thermal exposure-related accidents did not wear protective gloves at the time of the accident [82]. Although partial gloves may improve manual dexterity, while isolating the palm from the handle vibration, these gloves do not comply with the AV gloves screening criteria defined in the ISO 10819 standard [73].

Manual dexterity has been defined as a motor skill determined by the ranges of motions of the arm, hand and fingers, and the possibility of manipulations with hands and fingers. It is a combination of reaction time, tactile sensation, nerve conduction, grip strength and mobility. It may be classified as finger dexterity and hand dexterity. Finger dexterity is associated with fine motor skills required for manipulations of relatively small objects, while hand dexterity involves gross motor skills for handling relatively large objects. Factors affecting manual dexterity include restriction of movement, loss of bending of fingers, poor contact due to thickness or lack of conformability of the glove, coefficient of friction, and poor fit of the glove [14].

The manual dexterity of conventional gloves has been widely studied using different methods. A number of standard tests have been developed for measuring finger dexterity, wrist movements and hand dexterity provided by chemical- biological- or heat-resistant protective gloves [83]. None so far, to the author's knowledge, has been specific to AV gloves. A number of methods have been reported for laboratory measurements of manual dexterity [14], which generally involve participants to perform specific tasks as quickly as possible such as pick and place discs or pins in holes, or assembly tasks with nuts and bolts. These include Bennett hand tool dexterity test [84], Minnesota rate of manipulation-turning or pegboard tests [85, 86], O'Connor dexterity test [87],

the Purdue Pegboard Test [88]. A few studies have also assessed the dexterity of workers wearing gloves while conducting work-specific handling tasks or over the course of a regular shift such as the Pennsylvania bimanual work sample assembly test [89] and rope knotting test [90].

It is difficult to compare the outcomes of various methods to discriminate among gloves, since these involve different procedures and reflect different capacity. The choice of a dexterity test method generally depends on the conditions and purpose of the study such as measurement of fine finger or whole hand dexterity. Tests requiring the handling of small parts, such as Crawford-Screws and O'Connor Finger, showed better sensitivity for discriminating the fine and medium dexterity performance of gloves. Conversely, Minnesota test [85] and ASTM F2010 [91] test methods showed better sensitivity for discriminating medium and coarse dexterity [92]. Although dexterity tests specific for AV gloves have not yet been defined, the above-stated tests could be applied to study manual dexterity of AV gloves.

It has been suggested that the selected method should ensure sufficient complexity of the task to help reveal significant differences among the gloves, without being too laborious or difficult to perform with the gloves [83]. A number of factors were considered in the choice of dexterity tests, such as ability to discriminate between gloves being tested, control of learning effect, run time, and ease of scoring and administration [83]. Gauvin et al. [92] conducted a comprehensive study of 12 different dexterity tests using 9 different protective gloves, and concluded that combinations of several test methods could provide high overall sensitivity, ranging from 81 to 89%, and reasonable runtime (7-15 minutes). The combinations included Two-hand turning & placing Minnesota or the O'Connor Finger, together with one of the three Purdue tests and the ASTM F2010 or Crawford Screws test.

The reported efforts in evaluating the ergonomic and manual dexterity properties of protective gloves may be grouped in three broad categories on the basis of the study goals. The first one focuses on timed manual dexterity tests involving screwing or gripping small objects of different shapes with the hand or a tool. Bradley [93] measured time required for control of switches and levers, and showed dependence of the control operation time on type of glove and the control task. Plummer et al. [94] conducted the Bennett hand tool dexterity tests to study the effect of ten different hand conditions (six double gloves, three single gloves and bare-handed) on participants' hand performance. The results showed that gloves increased the average completion time by 15 to 37 %. Several double gloving combinations had significantly longer completion times compared to

the single gloves. Banks and Goehring [95] performed the assembly/disassembly of underwater pipe puzzle task and found that the use of thick navy diving gloves increased the task time by 50 to 60%.

The second group of studies concerns the function of the upper limbs muscles while performing routine tasks at the workplace or during manual dexterity tests. Willms and Wells [96] conducted a battery of maximal and submaximal gripping tasks with three different thicknesses of rubber gloves, wearing interdigital spacers between the fingers and a bare hand to determine contributions of the loss of tactile sensitivity, glove flexibility, glove thickness, and changes in finger geometry to force decrement and increased effort during power grip. The results showed increase in grip force imparted by the participants and the muscles' activity with increasing glove thickness for a submaximal force. Dianat et al. [15] investigated effects of three different types of gloves (cotton, nylon and nitrile gloves) on hand performance capabilities such as muscle activity, dexterity, touch sensitivity, finger pinch and forearm torque strength in addition to participants' assessment of discomfort, when performing a light assembly task. Wearing gloves significantly increased the muscle activity, pinch strength and discomfort but reduced the hand dexterity and touch sensitivity.

The third group of studies focused on the roles of mechanical and physical properties of gloves materials in terms of thickness, bending rigidity and friction. Bensel [97] investigated the effect of different glove thicknesses on five dexterity tests, and concluded nearly linear increase in completion time with increasing glove thickness. Nelson and Mital [98] evaluated the effect of latex glove thickness on manual dexterity and tactility in addition to the puncture resistance, and concluded that a 0.83 mm thick latex glove could provide dexterity and tactility comparable to the bare hand, and effectively resist routine impact forces.

1.2.2 Grip strength performance of gloves

Apart from the discomfort and reduced manual dexterity, a few studies have shown that AV gloves, reduce the effective grip strength of the operator [99, 100], which may contribute to operator fatigue due to greater demand for the grip strength. Hand grip strength has been measured using widely different methods such as dynamometers, instrumented handles, and contact pressure sensors and indirectly with the use of surface electromyography (forearm muscle activation). Jamar dynamometer handles have been most frequently used for the measurement of grip strength [101-103]. Owing to the differences between the geometries of a dynamometer and tools' handles, the

grip strength measured by a dynamometer may not be representative of the grip force applied to tools' handles [100]. A number of studies have measured grip strength using instrumented handles of different cross-sections that may closely simulate the geometries of tools' handles [3, 100, 104, 105]. The majority of the instrumented handles used in grip force studies, however, only permit measurement of the grip force component along the forearm axis, while the measured grip strength strongly relies on the distribution of the hand-handle contact force on the handle surface [106].

The effect of AV gloves on the grip strength has been mostly assessed under power grip condition with maximum voluntary contraction (MVC). Hamouda et al. [3] evaluated the grip strength reduction of 12 different gloves (11 AV gloves and 1 protective glove) using a cylindrical instrumented handle under the MVC condition with negligible push force. The study showed 27% to 41% reduction in the grip strength by the AV gloves, when compared to the bare hand (BH). A correlation of the grip strength reduction with the glove thickness was not observed. The instrumented handles permit measurement of the grip force in a plane normal to the forearm axis, which may not be representative of the grip strength. Wimer et al. [107] proposed a handle dynamometer design for measuring grip effort in terms of total contact force normal to the surface of a handle. The handle was used to measure the effects of AV gloves on the grip strength in a power grip condition with MVC [100]. The measurements conducted with 6 different gloves, including four AV gloves made of air pocket and gel materials, revealed more than 29% reduction in grip strength by the AV gloves, when compared with the bare hand trials. The glove thickness was reported as the primary factor affecting the grip strength. The measured grip strength was considerably higher than that obtained with a Jamar dynamometer, which is limited only to the plane normal to the forearm. The grip strength also increased considerably with decrease in handle diameter, which has also been reported by Aldien et al. [108] and Yao et al. [16] through measurements of hand-handle interface contact pressure. Welcome et al. [109] measured hand grip strength with and without wearing an AV glove with subjects applying MVC effort on the 40 mm diameter instrumented handle developed by Wimer et al. [107]. The study showed considerable reduction in grip strength by the AV gloves, ranging from 30.7% for an air bladder glove to 42.1% for a gel-filled glove. Evaluations of loss of grip strength on the basis of MVC, however, can be associated with many limitations leading to high variabilities in the measured data such as difficulty in maintaining MVC for the measurement duration that may also depend upon subjects' motivation

and muscular fatigue [110]. Moreover, the MVC condition is not representative of the grip force applied to the tools' handles.

A few studies have quantified grip strength through the integration of the hand-handle contact pressure over the contact area under different ranges of grip and push forces imposed by the hand on the handle. These have measured distributed hand-handle contact pressure, effective contact area, and contact and coupling forces developed at the hand-handle interface using resistive and capacitive thin-film and flexible pressure sensing systems, while considering different sizes of cylindrical and elliptical cross-section handles [108, 111-113]. Relationships were proposed to estimate the contact force, representing the grip strength, from directly measurable grip and push forces as a function of the handle diameter [108, 114]. The relationships, however, were limited only to bare hand grasping a handle. Such measurement systems are not suited for assessing grip strength reduction by AV gloves, which may alter the distribution of the contact pressure and thus the force. Wimer et al. [100] have measured the effect of gloves on the resulting contact force distributed at the surface of an instrumented cylindrical handle.

Alternatively, a few studies have developed flexible thin-film sensors and sensing grids for direct measurements of contact force developed at the palmar side surface of a gloved hand grasping a handle. Lemerle et al. [17] investigated the accuracy of an instrumented glove integrating capacitive pressure sensors, developed as a part of the VIB-TOOL project, for measurement of grip, push and contact force developed at the hand-handle interface. The application of the glove sensor, however, was reported to be cumbersome, especially in field applications. Yao et al. [16] reported the design of a flexible thin-film hand sensor that could be positioned between the palmar hand surface and an AV glove for measurement of total contact force developed at the viscoelastic hand-glove interface. The results suggested higher grip strength demand for a gloved hand and hand gripping a viscoelastic handle compared to a bare hand condition for realizing the same level of grip/push force combination. Such sensors integrated within the glove, however, may limit mobility of the fingers and cause large inter-subject variabilities attributed to differences in positioning of the sensor within the glove. The resistive sensing grid also revealed notable errors due to drift and temperature-dependency of the measured force. Moreover, glove sensors pose calibration challenges when wrapped around the handle. The reliability of reported glove sensors for measurements of hand-glove contact force is not yet proven.

Another alternative is to measure the adverse effect of AV gloves on different muscles activities using a surface electromyography (EMG) methodology allowing to assess grip strength indirectly, but under more practical or generalizable submaximal grip conditions [15, 18, 96, 115]. In other words, instead of measuring the grip strength induced by the glove stiffness, the activation level is measured during submaximal contractions, which represents a corollary measure. Wells et al. [116] investigated various performance measures of protective gloves (rating of effort, EMG, manual dexterity) while performing a set of standard tasks with protective gloves of different sizes and thicknesses. Wearing gloves significantly increased muscle activities and decreased manual dexterity, which concurred with another study by Dianat et al. [15]. The stiffness of the gloves led to the fatigue on the muscles [15]. In fact, glove thickness and manual dexterity should be negatively correlated [97, 98], as recently substantiated in our recent study ($r^2 = 0.61-0.77$) with the use of two different dexterity tests [2]. Furthermore, a higher gloves thickness leads to reduction in the grip strength [100, 117].

Larivière et al. [18, 115] proposed a surface electromyography (EMG) methodology allowing to estimate the effect of glove stiffness on the activity of four forearm muscles during standardized grip contractions (35% MVC). Forearm muscle activities were highly correlated ($n = 27$ gloves) to the rating of effort ($r = 0.88-0.95$) and to two mechanical tests of glove stiffness ($r = 0.77-0.94$), while the range of correlation values was dependent on the muscle tested [115]. Effectively, the four muscles investigated were not equally sensitive to the different glove conditions. This methodology needs to be applied to AV gloves but with further refinements for simplification, namely by eliminating the use of MVCs to normalize EMG and to define the grip load. More specifically, it is proposed to normalize EMG to the EMG collected during the bare hand condition and to use absolute loads (e.g., 25 N and 50 N) instead of a relative load (e.g., 35% MVC).

1.3 Scope and objective of the dissertation

The primary objective of the dissertation research is to develop a methodology for evaluation of integrated performance of AV gloves, considering the distributed nature of transmitted vibration to palm and fingers through gloves, manual dexterity, grip strength at the hand/glove interface. The specific goals of the dissertation research are summarized below:

- i)* Identify appropriate methods for assessing manual dexterity of AV gloves and assessing the influences of AV gloves on the manual dexterity;

- ii) Develop a measurement system to study the grip strength reduction due to AV glove by directly measuring the contact force distributions at the hand-handle/glove interface;
- iii) Measure the vibration transmitted to palm and fingers of the gloved hand, by using the standard palm adaptor and developed finger adaptors, respectively;
- iv) Investigate the influences of AV gloves on the grip strength using the muscles activation via EMG;
- v) Explore correlations among the different measures, i.e., vibration transmission to the palm and fingers, and reductions in manual dexterity and grip strength, major glove design factors for different gloves;
- vi) Develop a methodology for integrated performance analyses of anti-vibration gloves for defined work conditions and propose a glove design guidance.

The technical route and framework of this dissertation are illustrated in Figure 1.3.

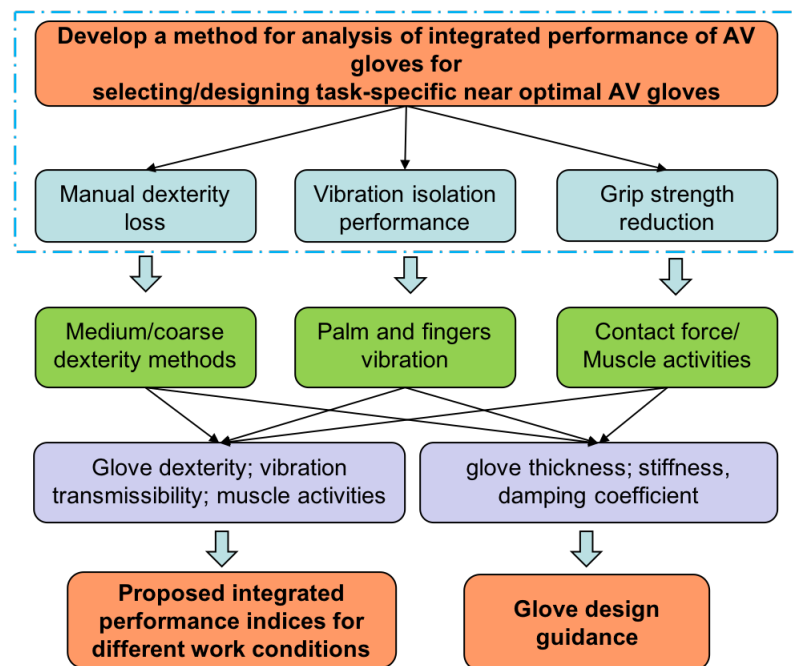

Figure 1. 3: Technical route and framework of this dissertation

1.4 Organization of the dissertation

This dissertation is prepared according to the manuscript-based format described in “Thesis Preparation, Examination Procedures and Regulations” guidelines of the School of Graduate Studies, Concordia University. This dissertation research is organized in 7 chapters and appendix, which address the research goals mentioned above, including the Introduction and Literature Review chapter (Chapter 1) and the concluding chapter (Chapter 7). The first chapter mainly

summarizes a comprehensive literature review of studies reporting the hand-transmitted vibration characteristics and health effect as well as the vibration control. In chapter 2, manual dexterity performance of 10 gloves were investigated via conducting two dexterity tests (goal *i*). Chapter 3 presents the development of the hand sensor measurement system and its application for studying the relations among hand forces imparted on a viscoelastic hand-handle interface (goal *ii*). Chapter 4 presents the correlations between the transmitted vibration at the palm and fingers and the manual dexterity of AV gloves (goals *iii* and *iv*). Chapter 5 presents the effect of AV gloves on the activities of the dominant forearm muscles of AV gloves (goal *v*). Finally, a methodology of the evaluation of the integrated performance of AV gloves is proposed in Chapter 6 for helping operators to select near optimal AV gloves for different work conditions (goal *vi*). Chapters 2 to 6 are compiled from 3 manuscripts published in international peer-reviewed journals, and 2 manuscripts submitted to the journals for review. The references in each chapter are reorganized so as to eliminate duplications. Furthermore, the ‘Introduction’ sections in Chapters 2 and 5 have been condensed, since a more comprehensive review of relevant studies has been presented in Chapter 1. The highlights of the manuscripts are further summarized below:

Chapter 2 presents the following article published in the *Ergonomics Journal*: Yao, Y., Rakheja, S., Gauvin, C., Marcotte, P., and Hamouda, K. (2018). *Evaluation of effects of anti-vibration gloves on manual dexterity*. *Ergonomics*, 61(11), 1530-1544.

Anti-vibration gloves can limit the hand-transmitted vibration but may adversely affect manual dexterity and work precision. The purpose of this study was to evaluate the effects of anti-vibration gloves on manual dexterity and explored the factors affecting the manual dexterity. The manual dexterity of ten different gloves were investigated with 15 adult male subjects via performing two different dexterity tests, namely, ASTM F2010 standard test and Two-hand Turning and placing Minnesota test. Two-factor repeated-measures analysis of variance was conducted to evaluate the main effects of glove type, test method, and their interaction effect on manual dexterity. Results suggested that glove type yielded significant effect on manual dexterity ($p < 0.001$), while no significant difference was observed between test methods ($p = 0.112$). The interaction effect of glove type and test method also revealed significant difference ($p = 0.009$). The glove thickness was further showed moderately significant difference on the number of drops during the tests, while manual dexterity decreased nearly linearly with increase in the glove thickness.

Chapter 3 presents the following paper published in the Measurement Journal: Yao, Y., Rakheja, S., and Marcotte, P. (2019). *Relationship among hand forces imparted on a viscoelastic hand-handle interface. Measurement, 145, 525-534.*

This study described the design and assessments of a flexible thin-film hand sensor for measurements of contact pressure/force distribution at an elastic hand-handle interface, including the contact force developed by a gloved-hand grasping a tool handle. The static properties of the hand sensor were evaluated in terms of its drift, linearity, repeatability and hysteresis under global as well local loading. The measured results revealed low hysteresis (<6%) and drift ($\approx 2.9\%$ over 30 s), good linearity ($r^2=0.99$) and repeatability (CoV=1.5%). Subsequently, an experiment was designed to establish a relationship among the grip, push and contact forces imparted on a flexible hand-handle interface. The experiments involved three different hand-handle interface conditions: (i) bare hand grasping an instrumented rigid handle (RH); (ii) hand grasping the instrumented flexible handle (FH) enveloped by a viscoelastic anti-vibration material; and (iii) gloved hand grasping the handle (GV). The measurements with each interface were conducting with five male subjects and nine combinations of grip (10, 30 and 50 N) and push (25, 50 and 75 N) forces. The measured data were analyzed via multiple linear regression method to explore relationships among the grip (F_g), push (F_p) and contact (F_c) forces for each hand-handle interface. The data were further analyzed to investigate the effect of anti-vibration (AV) gloves on the hand grip strength. The relationship obtained for the hand grasping a rigid handle showed good agreement with those in the reported studies, which verified the hand sensor feasibility for application to curved surfaces. The relationship obtained for the bare hand grasping the handle with flexible anti-vibration material, however, showed higher coefficients of grip (α_g) and push (α_p) forces compared to those observed with the rigid handle of same diameter. Similar trend was also obtained for the gloved hand grasping the handle, which suggested higher grip strength demand for a gloved hand (GV) and hand coupling a flexible handle compared to the RH condition for realizing the same level of grip/push force combination.

Chapter 4 presents the following paper accepted for publication in the Ergonomics Journal: Yao, Y., Rakheja, S., and Marcotte, P. (2019). *Distributed vibration isolation and manual dexterity of anti-vibration gloves: Is there a correlation? Ergonomics.*

This study focused on the integrated performance of anti-vibration (AV) gloves in terms of manual dexterity and distributed palm and fingers' vibration transmissibility. Experiments were

designed to measure vibration transmission and manual dexterity performance of 10 different gloves using 15 subjects. The results showed all gloves impeded manual dexterity, while five gloves satisfied the AV glove screening criteria (ISO 10819, 2013). Glove type yielded a significant effect on manual dexterity ($p < 0.001$) and vibration transmissibility ($p \leq 0.001$). Manual dexterity decreased nearly linearly with increase in glove thickness ($p < 0.05$), while palm and fingers' vibration transmissibility in high-frequency range was negatively correlated with glove thickness ($r^2 > 0.70$). A strong correlation was evident between glove material stiffness and the H- frequency range palm vibration transmissibility ($r^2 \geq 0.8$). While the vibration isolation of a glove is strongly related to material properties at the palm, the dexterity performance is dependent on design factors such as thickness and bulkiness.

Chapter 5 presents the following paper that has been submitted to the Journal of Human Factor: Yao, Y., Rakheja, S., Christian Larivière and Marcotte, P. (2019). *Measurement of forearm muscle activities to study anti-vibration gloves: sensitivity and construct validity issues, Human factor.*

Anti-vibration gloves impose relatively higher grip exertion, which may cause an increased risk of musculoskeletal disorders. Consequently, forearm muscles activities should be considered when assessing anti-vibration glove performance. The primary objective of this study was to assess the effect of anti-vibration gloves on forearm muscles' activities. Specific objectives included identification of most sensitive muscles to discriminate between gloves and assessing their construct validity with regard to manual dexterity test. Experiment was designed to measure effects of anti-vibration gloves on activities of the main forearm muscles via surface electromyography, while gripping a handle under two levels of pure grip force (25 N and 50 N). Fifteen subjects participated in experiments with 11 hand conditions involving 9 different anti-vibration gloves, a protective glove and bare hand. The activity of ECR, FCR, ECR_FCR combination, and mean of all four muscles (X-all) were sensitive to wearing gloves. The X-all was 21% to 61% higher with anti-vibration gloves when compared to the bare hand. The correlation coefficient (r) between the ECR_FCR muscles' activities and glove thickness, and between the ECR_FCR muscles' activities and manual dexterity were 0.74 and 0.90, respectively. Combined activities of ECR and FCR could serve as an effective measure for assessing the effect of anti-vibration gloves on forearm muscles during grip exertions. A better understanding of the effects of anti-vibration gloves on forearm

muscles activities can yield essential design guidance for anti-vibration gloves and a possible measure of grip exertion by gloved hand.

Chapter 6 presents the following paper that to be submitted to the Journal of Applied Ergonomics: *Yao, Y., Rakheja, and Marcotte, P. (2020). A methodology for integrated performance analyses of anti-vibration gloves, Applied Ergonomics.*

This study proposes a methodology for evaluating integrated performance of anti-vibration (AV) gloves considering manual dexterity, distributed palm and fingers' vibration transmission and grip strength preservation, which generally pose conflicting design requirements. A methodology based on analytical hierarchy process (AHP) is proposed to identify weights for the conflicting performance measures for the given work condition, classified in accordance with the frequency ranges of predominant tool handle vibration (low and high), as defined in ISO 10819 (2013) together with the assembly/disassembly tasks. An index of the weighted measures is formulated for identifying the most desirable AV glove for the given work condition. The results showed that the weighting for the fingers vibration response is the most influential factor for the high frequency vibration spectra. For low frequency vibration spectra, the weightings for the palm vibration transmission and the muscles' activity, were greater than those for the manual dexterity and fingers vibration transmission. For tasks involving assembly/disassembly in addition to the power tools operations, the weightings for the manual dexterity and muscles' activity were higher than those for the vibration transmissibility. An integrated performance index is identified and applied to rank five different AV gloves with known individual performance measures for identifying the most desirable glove.

Appendix, comprised of three parts, summarized the detailed statistical analyses methods used in this thesis. Part A presents the two-factor repeated-measures analysis of variance (rANOVA) which includes the hypotheses, F test, post hoc test (Bonferroni and Tukey HSD), effect size, and Pearson's correlation coefficient. These analyses methods were used in the Chapter 2, 4 and 5. Part B introduces the multiple linear regression analysis method which used in the Chapter 3 to explore the relationships among the grip, push and contact forces for three different hand-handle interfaces. Part C summarizes the method of two-factor multivariate analysis of variance (MANOVA) which was performed in Chapter 4 to determine the significant influences of different gloves and frequency ranges as well as their interaction on the frequency-weighted palm and fingers' vibration transmissibility.

CHAPTER 2: EVALUATION OF EFFECTS OF ANTI-VIBRATION GLOVES ON MANUAL DEXTERITY

2.1 Introduction

Operators of hand-held power tools are exposed to high magnitudes of hand-transmitted vibration (HTV) arising from tool-work surface interactions. Many epidemiological studies have established a strong association between HTV and various vibration-related injuries [118]. The most serious one among the diseases caused by prolonged exposure is perhaps the vibration-induced white finger disease [48]. It is generally agreed that the onset of these disorders can be reduced by decreasing the magnitude of HTV, which is further supported by the dose-response relationship defined in ISO 5349-1 [19].

Anti-vibration (AV) gloves made of vibration isolation materials are considered as an efficient and convenient way to attenuate exposure to HTV. However, the effect of AV gloves on hand performance capabilities should not be ignored. Wearing gloves may require greater grip force to resist hand slippage, which may lead to the compressive forces on the tissues in the palm and fingers, and increase the risk of HAVS in repetitive manual works in the presence of HTV [119, 120]. Anti-vibration gloves can limit the hand-transmitted vibration but may adversely affect manual dexterity and work precision. The manual dexterity of AV gloves has not been attempted, although manual dexterity of conventional gloves has been widely studied using different methods.

In the present study, the manual dexterity performance of AV gloves together with the roles of selected design factors were investigated with 15 adult male subjects. The ASTM F2010 and Minnesota test methods were selected to explore the effect of AV gloves on fingers' and whole hand dexterity, respectively, since these tests have shown better sensitivity for discriminating the medium and coarse dexterity gloves [92]. Ten gloves including nine different types of AV gloves and one conventional glove were conducted for the study. While the bare hand condition served as the reference. The measured data in terms of completion time and number of drops during the trials were analyzed to investigate and compare the effect of wearing typical industrial AV gloves on manual dexterity using the two-factor repeated ANOVA. The correlations between the manual dexterity with glove thickness, hand size and finger's length were also explored. The detailed statistical analysis methods used in this study present in the Appendix A. The roles of selected

design factors were further explored to seek guidance on designs of AV gloves which can provide better manual dexterity apart from vibration isolation.

2.2 Materials and Methods

2.2.1 Participants

Fifteen male subjects aged between 22 to 35 years, participated in the experiments. All the participants were healthy and had no prior history of upper limbs injuries. None of the participants had been professionally involved in working with hand tools. Four of the participants were left-handed. The aim of the study and experimental procedures were described to each participant together with his rights and responsibilities. Each participant consented to the experimental protocol, which had been approved by the Human Research Ethics committee of Concordia University. The dimensions of the participants' dominant hand were measured to determine the hand size in accordance with EN 420 standard [121], which defines hand size ranging from 6 to 11 on the basis of measured hand dimensions. This included hand length, between the wrist and tip of the middle finger, and palm circumference measured 20 mm from the crotch between the thumb and the index finger. Measured hand dimensions together with selected anthropometric dimensions of the participants are summarized in Table 2.1 in terms of minimum, maximum, mean and standard deviation of the mean. The hand sizes of the subjects, determined in accordance with EN 420 [121], ranged from 8 to 10 (Table 2.1). Since the fitness of the gloves to the hand is a critical factor in view of manual dexterity, the participants were screened considering the hand size (≥ 8) and the degree of fitness of the candidate gloves. Although some of the AV gloves suppliers specify their gloves for hand sizes equal to or above 8, the specified sizes however differed from the standardized sizes depending on the vibration isolation and glove materials. The fitting of the gloves was determined by asking the participant to try different sizes of the same glove type and select a size that fits the best and permits adequate fingers and hand movements. For this purpose, gloves of different sizes, ranging from 8 to 11 (when the standardized size is specified) or small to extra-large. Participants with acceptable fitting of at least 8 of the 10 glove types were retained for the study. Each participant was familiarized with the two test methods with a single trial of two hand treatments to ensure that the participant could undertake the required tasks. These included a bare hand trial and a trial with a relatively thick and bulky AV glove.

Table 2. 1: Hand and selected anthropometric dimensions of participants

Parameter	Maximum	Minimum	Mean	Standard deviation
Age (years)	35	22	27.54	3.71
Height (cm)	181	169	174.81	5.51
Body weight (kg)	79	60	70.27	6.33
Hand length (mm)	205	180	188.73	7.24
Palm circumference (mm)	220	185	197.67	10.59
Hand size	10	8	8.93	0.7
Thumb length (mm)	70	59	63.79	4.44
Index-finger length (mm)	81	69	74.19	3.77
Middle-finger length (mm)	90	74	83.06	5.14

2.2.2 Selection of dexterity test methods

In order to select suitable tests and to standardize test procedures for the AV gloves, repeated measurements were performed by the experimenters using three test methods with bare hand and different gloves. These included the Bennett Hand Tool test, the combinations of Two-hand turning & placing Minnesota test and ASTM F2010 standardized test, as recommended in [92]. Subsequently, the Bennett Hand Tool test was discarded since it was difficult to perform and involved very long completion time. Alternatively, Minnesota test and ASTM F2010 tests were selected to study the impact of AV gloves on manual dexterity. Minnesota test, consisting of two test boards and 65 plastic discs, as shown in Figure 2.1a, is considered to represent both fine finger and whole hand dexterity, whereas the ASTM F2010 method, including a pegboard and 25 steel pins (Figure 2.1b), could measure fine thumb and index fingers dexterity of the dominant hand. These two methods, denoted as ‘ASTM’ and ‘Minnesota’ hereafter, were subsequently selected for the study.

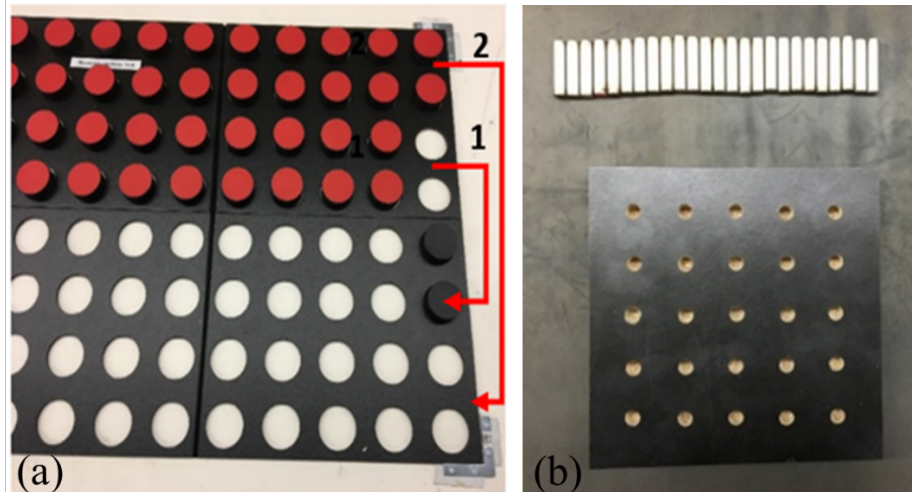

Figure 2. 1: (a) Minnesota test apparatus; and (b) ASTM F2010 test apparatus.

For the Minnesota dexterity test, the apparatus was placed on a 72 cm high work table. Each participant was asked to stand facing the table and pick two plastic-discs simultaneously (one with each hand) from one of the two boards and place them on the second board while turning the discs upside-down. The participant was advised to start with discs located in the two bottom rows of the upper board and place them to the two top rows of the lower board. This was followed by picking the discs of the two top rows of the same column and placing them in the bottom rows of the lower board.

For the ASTM test, each participant was required to sit on an adjustable chair facing the work bench, where the ASTM pegboard was placed. Participants were advised to assume a comfortable working posture by adjusting the seat height. Each participant was required to pick 25 steel pins, one at a time, with his dominant hand and place them into the pegboard, starting from the top left corner of the board. Owing to the difficulty in grasping the pins from the workbench with a gloved hand, each steel pin was picked by pushing the lower end with the thumb and then holding it by both the thumb and the index finger.

2.2.3 Gloves

In this study, ten different gloves were selected to explore their effects on manual dexterity, including nine different types of AV gloves and one fabric protective glove. The selected AV gloves were acquired from 5 different manufactures, and are considered to represent the range of commercially-available AV gloves. These included: five gloves with gel vibration isolation materials, denoted as *gel1*, ..., *gel5*; two gloves with air pockets vibration isolation material, denoted

as *air1* and *air2*; one hybrid glove comprising air pocket vibration isolation material in the palm region and gel in the fingers regions, denoted as *hybrid*; and one rubber glove, denoted as *rubber*. Each of the selected AV gloves, with the exception of *hybrid*, employed same vibration isolation material in the fingers and palm regions, as required by ISO 10819 [11].

In order to explore correlation between the glove thickness and manual dexterity, the overall undeformed thickness of the glove material between the hand and the contacting surface was measured in the index finger and palm regions. For this purpose, each glove was cut in the two regions and undeformed thickness was measured using a caliper. Table 2.2 presents pictorial illustrations of the gloves and the glove materials in the fingers' region, brief description of the construction, undeformed thickness in the palm and fingers regions, and index finger region width, measured from seam-to-seam.

Table 2. 2: Brief descriptions of the vibration isolation materials and glove coverings

Label	Pictorial view	Fingers material	Glove material	Thickness (mm)		Index finger width (mm)
				Palm	Finger	
<i>gel1</i>			Viscoelastic polymer <i>gel</i> covered with medium soft leather.	4.4	4.4	38.5
<i>gel2</i>			<i>Gel</i> padded with foam and covered by soft stretchy fabric and elasticized back.	6.8	6.6	34.0
<i>gel3</i>			Thick vibration damping polymer covered by soft goatskin in contact area and elasticized back.	8.2	8.2	35.4
<i>gel4</i>			<i>Gel</i> material covered by moderately soft leather in contact surface and elasticized cloth back.	4.3	4.1	32.3
<i>gel5</i>			<i>Gel</i> polymer layers covered by abrasion resistant pigskin leather.	8.0	8.0	34.5
<i>air1</i>			<i>Air</i> bubble isolation material covered by stiff cowhide leather.	7.2	7.2	40.3
<i>air2</i>			<i>Air</i> bubble isolation material covered by soft pearl leather in contact areas with nylon fabric back.	6.7	6.7	33.4
<i>hybrid</i>			<i>Gel</i> and foam in fingers and air bubble in palm, covered by soft pearl leather in contact areas and nylon fabric back.	8.1	5.7	33.4
<i>rubber</i>			Thermoplastic rubber with its coating. The base part of the glove is a knit.	1.5	1.5	30.0
<i>fabric</i>			<i>Fabric</i> in the fingers and palm regions	1.1	1.2	28.6

2.2.4 Measurements

The measurements were performed with each of the fifteen selected participants and a total of 11 hand treatments (bare hand and 10 gloves) in three different sessions held on different days over a period of three weeks. Each session included trials with 3 to 4 different gloves combined with the two test methods. Each session also included a bare hand trial as the reference. Each participant completed all the tests during three different days (one session each day) to avoid fatigue. The sessions with a given subject were held from 1 to 7 days apart to minimize the learning effect, although the gap between consecutive sessions was not considered important in the study.

The order of measurements with different glove type-method combinations during all the three sessions was randomized. Each subject was provided with the glove sizes that were determined to provide good fitting during the recruitment/screening session. The participants were advised to perform the tasks as precisely and quickly as they could, and they were instructed to start the test when the experimenter announced the word ‘Ready? Go’. The participants were asked to not pick any dropped pins or discs, the experimenter restored them to the stack. No visual feedback or verbal encouragement regarding the participant’s performance was given during the trials in accordance with the recommended protocols. Participants were given 1 minute break between trials and two minutes break when the hand condition was changed. The completion time of each trial was recorded using a digital stopwatch. Each glove-test method combination test involved multiple trials by the subject until the coefficient of variation in the completion time of the last three trials was less than 8%. The completion time for each combination was subsequently defined as the mean of the recorded times for the last three trials. The number of drops during each trial was also recorded to explore its relationships with manual dexterity and glove thickness. The total number of drops for each glove-test method combination was recorded as the sum of drops during the three final trials.

2.2.5 Data analysis

The number of trials for different glove-test method combinations ranged from 3 to 9. The intra-subject variability was limited to 8% in both the methods. The manual dexterity score was defined as the completion time for each glove-test method combination for each subject during a given session, normalized with respect to the reference completion time obtained with bare-handed measurements during the same session, such that:

$$\text{Manual dexterity score of a glove} = \frac{\text{completion time while wearing glove}}{\text{completion time bare-handed}} \quad (2.1)$$

The completion time, manual dexterity score and number of drops obtained for different gloves and test methods were expressed in terms the maximum, minimum, mean and standard deviation values. Pearson's correlation coefficient was used to assess relationships between the manual dexterity score and the number of drops for each method. The results were not significant ($p>0.01$), which suggested that each outcome could be treated as the response from a separate and independent experiment and could be analyzed by analysis of variance (ANOVA) instead of multiple analysis of variance (MANOVA).

Statistical analyses were performed with SPSS software version 22.0. In the analyses, ten glove types and two dexterity tests constituted the independent variables, while manual dexterity offered by the gloves was taken as the dependent variable. Since manual dexterity was measured under different glove-method combinations and at different time periods for each participant, two-factor repeated-measures analysis of variance (rANOVA) were conducted to evaluate main effects of the glove types, tests and their interaction on manual dexterity. These statistical tests were based on within-subject variability, which are very powerful and could reduce error variance. The assumption of rANOVA is sphericity which was examined via conducting Mauchly's test of sphericity. The sphericity could not be established since the probability of Mauchly's test statistics was less than 0.05. Subsequently, Greenhouse-Geisser correction was introduced since the epsilon was below 0.75. The significance level of 5% was used for the statistical tests.

While rANOVA can reveal differences among different gloves, it may not show significant difference between two specific gloves. Post Hoc tests were thus performed to identify significant differences between different gloves. Owing to the expected significant effect of glove type on manual dexterity, Bonferroni test was applied for all comparisons so as to explore where the difference occurs among the gloves for each method. In addition, the Pearson's correlation coefficients between manual dexterity obtained with the two test methods were evaluated to test sensitivity for discriminating among different gloves. The correlations of the manual dexterity with glove thickness (index finger area), hand size and finger length were also evaluated using the same method. Owing to their bulky and relatively stiff design, the *air1* and *gell* gloves were treated as outliers, when analyzing the effect of thickness on manual dexterity. The data are further used to rank selected gloves based on the mean dexterity scores and Bonferroni test results.

Moreover, the number of drops for each glove-method combination was considered to study correlations of number of drops with the manual dexterity, glove thickness and hand size, if any.

For the purpose of further exploring the factors which affect the number of drops, the selected gloves were divided into two groups on the basis of the texture of the working surface. Group A included gloves with relatively smooth texture without streaks, namely, *gel1*, *gel3*, *air1*, *air2* and *hybrid*, whose surfaces are smooth without any veins, while group B included other gloves with relatively coarse texture.

2.3 Results

2.3.1 Completion time and manual dexterity

The completion time was evaluated as mean of the completion times for the last three trials with a coefficient of variation of less than 8%. The completion times of each glove for the ASTM and Minnesota test methods are presented as box plots in Fig. 2.2a and 2.2b, respectively. As expected, the results show the least completion times for the bare-handed (*BH*) tests. The results also show relatively lower completion times with the ASTM method compared to the Minnesota test method, as expected. The Minnesota method, however, shows higher inter-subject variability compared to that with the ASTM test. The results obtained with the ASTM test show greatest variability for the *gel1* gloves, while for the Minnesota test, larger variabilities are obtained for the *gel1*, *gel2*, *gel5* and *air1* gloves.

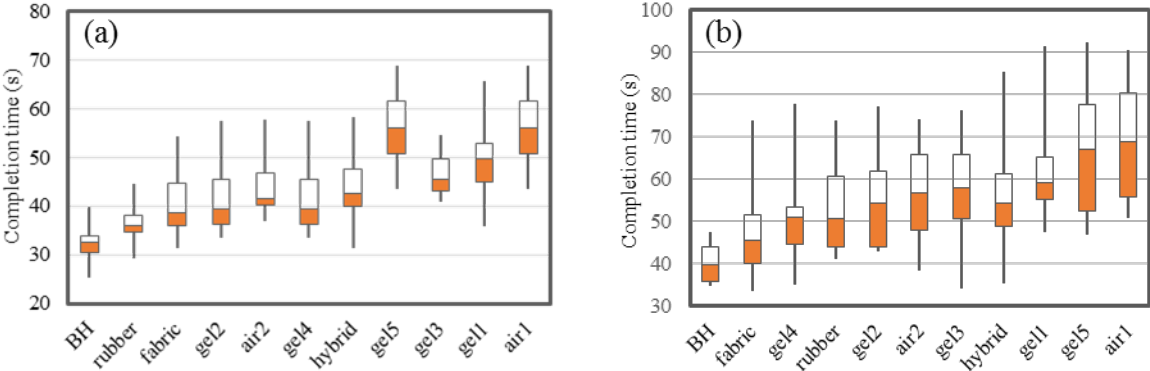

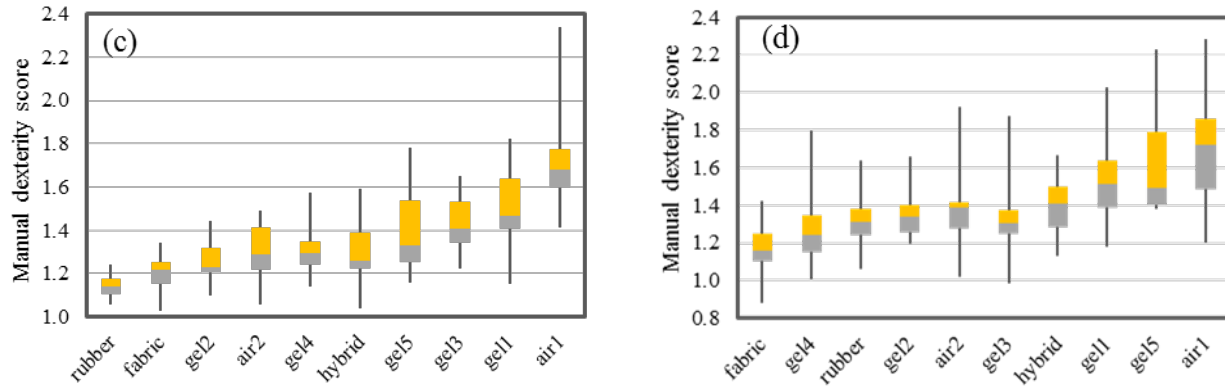

Figure 2. 2: Box plots of completion time and manual dexterity score: (a) ASTM F2010 test completion time; (b) Minnesota test completion time; (c) ASTM F2010 test manual dexterity score; and (d) Minnesota test manual dexterity score

The manual dexterity score of a glove is obtained by normalizing the completion time of the gloved hand with that of the bare hand measured in the same test session. The box plots of the resulting manual dexterity scores are shown in Figs. 2.2c and 2.2d. The results show mean manual dexterity score of all gloves in excess of unity value, irrespective of the test method, which suggest that all the tested gloves reduce manual dexterity. The *fabric* and *rubber* gloves exhibit the best dexterity, while the *air1* shows the worst dexterity followed by the *gel1* and *gel5* gloves for both the test methods. Greatest variability in manual dexterity is observed for the *air1* glove in both the test methods, followed by the *gel3* and *gel1* gloves for the Minnesota and ASTM tests. Higher standard deviations were observed for the *air1* and *gel5* gloves for both methods.

Two-factor rANOVA was performed to evaluate the main effects of glove type and test method, and interaction between the two on manual dexterity. The results show that the main effect of glove type has statistically significant difference on manual dexterity ($p < 0.001$), while the test method has no significant effect on manual dexterity ($p = 0.112$). The results also show significant interaction effect between the glove type and the test method on manual dexterity ($p < 0.01$).

In this study, Bonferroni test was conducted to examine multiple comparisons of the glove type for each dexterity test (45 pairs). The results are shown in Tables 2.3 and 2.4 for the ASTM and Minnesota tests, respectively. Of the 45 pairs, 21 pairs show significant differences ($p < 0.05$) for the ASTM test method (Table 2.3). For this test method, the *gel1*, *gel3*, *gel5* and *air1* gloves exhibit significant differences with respect to the conventional *fabric* glove. Among the AV gloves, the *rubber* glove is significantly different from all the AV gloves. The *air1* glove also shows significant differences with all AV gloves with the exception of only *gel1*. Excluding the *rubber*

and *fabric* gloves, the *gell*, *gel5* and *air2* gloves do not show significant differences with most of the AV gloves, with the exception of *gel2*, *gel4* and *air1*. The *gel2* shows significant differences with *rubber* and *gell*, apart from the *air1* and *gel3*. The *gel4* and *hybrid* gloves show significant differences only with *gell*, *air1* and *rubber*.

Table 2. 3: Results obtained from Bonferroni test to identify statistical differences between the gloves (ASTM F2010 test)

	<i>fabric</i>	<i>gel2</i>	<i>air2</i>	<i>hybrid</i>	<i>gel4</i>	<i>gel5</i>	<i>gel3</i>	<i>gell</i>	<i>air1</i>
<i>rubber</i>	1.000	0.024	0.011	0.036	0.007	0.004	<0.001	<0.001	<0.001
<i>fabric</i>		1.000	0.953	1.000	0.632	0.032	<0.001	0.017	<0.001
<i>gel2</i>			1.000	1.000	1.000	1.000	0.028	0.061	<0.001
<i>air2</i>				1.000	1.000	1.000	0.131	0.059	<0.001
<i>hybrid</i>					1.000	1.000	0.012	0.085	<0.001
<i>gel4</i>						1.000	0.057	0.039	<0.001
<i>gel5</i>							1.000	1.000	0.030
<i>gel3</i>								1.000	0.004
<i>gell</i>									0.445

Table 2. 4: Results obtained from Bonferroni test to identify statistical differences between the gloves (Minnesota test)

	<i>gel4</i>	<i>rubber</i>	<i>gel2</i>	<i>air2</i>	<i>gel3</i>	<i>hybrid</i>	<i>gell</i>	<i>gel5</i>	<i>air1</i>
<i>fabric</i>	1.000	0.970	0.136	0.975	1.000	0.057	0.008	0.004	<0.001
<i>gel4</i>		1.000	1.000	1.000	1.000	1.000	0.024	0.052	<0.001
<i>rubber</i>			1.000	1.000	1.000	1.000	0.243	0.085	0.014
<i>gel2</i>				1.000	1.000	1.000	0.170	0.081	0.024
<i>air2</i>					1.000	1.000	1.000	0.284	0.038
<i>gel3</i>						1.000	1.000	0.470	0.029
<i>hybrid</i>							1.000	0.002	1.000
<i>gell</i>								1.000	1.000
<i>gel5</i>									1.000

Unlike the ASTM test, the Minnesota test revealed significant differences for only 10 pairs (Table 2.4), which suggests that the Minnesota test may be relatively less sensitive for discriminating AV gloves. The results, however, show that the conventional fabric glove is not significantly different from most of the AV gloves, as observed in the ASTM test, with *gell*, *air1* and *gel5* being the exception. The *air1* glove shows significant differences with most AV gloves, as observed from the ASTM test, with few exceptions (*gell*, *hybrid* and *gel5*). Excluding the *air1*

glove, the *rubber* glove, unlike the ASTM test, is not observed to be significantly different from all the gloves. Similarly, *gel2*, *air2* and *gel3* also do not show differences with other gloves, with the exception of *air1*. Significant differences are also observed between *gel1* and *gel4*, and between *hybrid* and *gel5* gloves.

Furthermore, the Pearson’s correlation coefficients between glove thickness and manual dexterity score were obtained to examine correlations of manual dexterity score with the glove thickness in both the methods. Since the design of *air1* and *gel1* gloves are very bulky and relatively stiff, these gloves are treated as outliers when analyzing the effect of glove thickness on manual dexterity score. The relationships between the glove thickness and manual dexterity score, obtained from the two methods, are presented in Fig. 2.3. The results show good degree of correlations between glove thickness and manual dexterity score in both the test methods, which are statistically significant ($p < 0.05$). Moreover, the Pearson’s correlation coefficients between the hand size and the fingers lengths were explored. The results, presented in Table 2.5, do not show a correlation between the hand size and manual dexterity scores and between the fingers length and manual dexterity for both the methods (Table 2.5). The results, however, show good correlation between the manual dexterity scores obtained from the ASTM and Minnesota test methods ($r^2 = 0.68$).

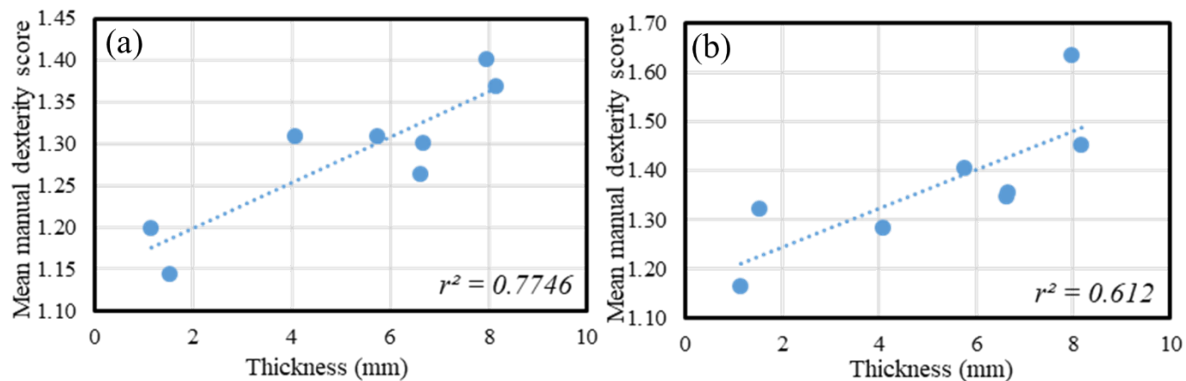

Figure 2. 3: Relationships between the glove thickness and manual dexterity score: (a) ASTM test; (b) Minnesota test.

Table 2. 5: Pearson’s correlation coefficients of manual dexterity with glove thickness and hand dimensions for the two test methods

Manual dexterity	r^2	
	ASTM	Minnesota
Glove thickness	0.775**	0.612*
Hand size	0.002	0.001
Thumb length	0.001	0.051
Index finger length	0.003	0.000
Middle finger length	0.000	0.002
ASTM vs. Minnesota test	0.68**	

*. Correlation is significant at the 0.05 level (2-tailed).

** . Correlation is significant at the 0.01 level (2-tailed).

2.3.2 Number of drops

Fig. 2.4a illustrates the total number of drops observed during the final three trials for each hand condition (bare and gloved) for the two test methods. The results show comparable general trends in both the tests for all the hand conditions. Greatest number of drops is observed with the *gel3* glove in both the tests. The least number of drops are observed with the *fabric* and *rubber* gloves in both the tests, which are similar to those with the bare hand trials. In order to compare the number of drops in two methods, percent drop rate was calculated with respect to total number of pins/discs handled during the three trials (75 pins in the ASTM test; 195 discs in the Minnesota test). The percentage drops for different hand conditions, presented in Fig. 2.4b, show considerably different trends for the two test methods. The drop rates for the ASTM test range from 0.4% to 2.2%, which are substantially higher than those obtained for the Minnesota test (0.2%~0.9%). This is due to difficulty in grasping the pins with the fingers in the ASTM test, especially for the gloved hand.

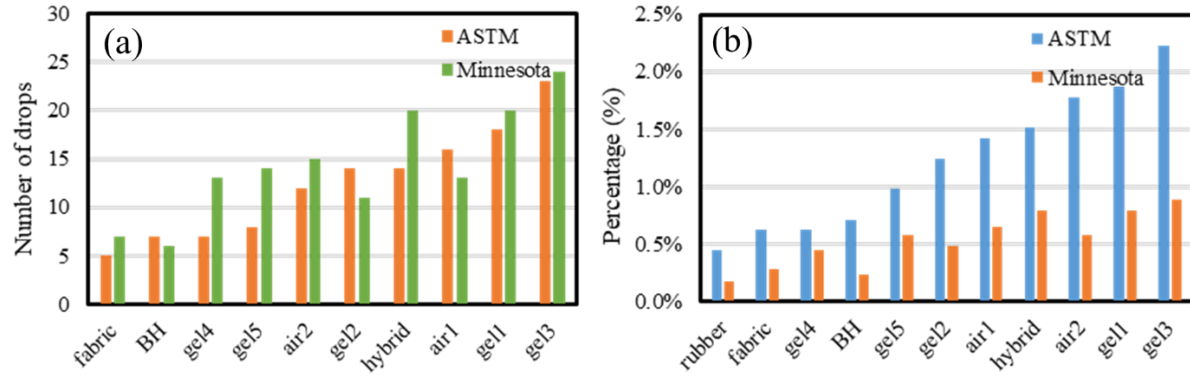

Figure 2. 4: (a) Total number of drops observed for each glove type; and (b) rate of drop for each glove type

Pearson's correlation coefficients were obtained to study correlations of the number of drops with glove thickness, hand size and manual dexterity score. The results presented in Table 2.6, show some degree of correlation between glove thickness and the number of drops ($r^2=0.41-0.43$), which is also statistically significant ($p<0.05$). Moreover, nearly no correlation is observed between the hand size and the number of drops. Some degree of correlation is also observed between the manual dexterity score and the number of drops in the ASTM test ($r^2=0.38$), which is nearly absent for the Minnesota test ($r^2=0.09$).

Table 2. 6: Pearson's correlation coefficients between number of drops and glove thickness, hand size and manual dexterity for each test

Number of drops	r^2	
	ASTM	Minnesota
Glove thickness	0.43*	0.41*
Hand size	0.00	0.03
Manual dexterity	0.38*	0.09

*. Correlation is significant at the 0.05 level (2-tailed).

The mean manual dexterity scores obtained from each test method are analyzed for the ranking of the gloves. The mean manual dexterity scores obtained from the two test methods show worst manual dexterity (highest score) for the *air1* glove (Fig. 2.5), while the best dexterity (lowest score) is observed for the *rubber* and *fabric* gloves corresponding to the ASTM and Minnesota tests. From the results obtained from the ASTM test, the gloves are ranked on the basis of manual dexterity score and the Bonferroni test results. The glove types are ordered according to manual dexterity score, which is observed as: *rubber* < *fabric* < *gel2* < *air2* < *hybrid* < *gel4* < *gel5* < *gel3*

$< gel1 < air1$. Bonferroni test results (Table 2.3) show *rubber* gloves have significant differences with all the gloves except for the *fabric* glove, while *fabric*, *gel2*, *air2*, *gel4* and *hybrid* gloves are not significantly different with respect to each other. Furthermore, *gel1*, *gel3* and *gel5* gloves do not show significant difference with each other, while *air1* is significantly different from all the gloves except *gel1*. These gloves are further ranked into six groups, indicated as I, II, III, IV, V and VI in Fig. 2.6a, on the basis of both the mean manual dexterity score (Figure. 2.5) and the pairwise comparisons (Table 2.3). The Figure 2.6 shows the mean dexterity scores of the gloves arranged in the above-identified order together with the similarity/differences among the gloves. The gloves within a group did not reveal significant difference among them, as determined from the Bonferroni tests (Table 2.3), although the manual dexterity score may differ.

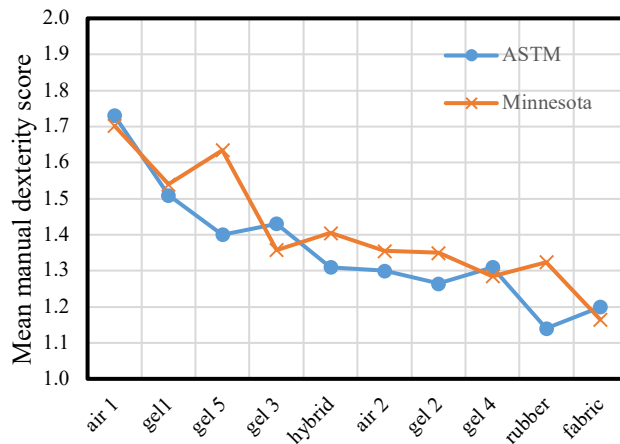

Figure 2. 5: Comparisons of mean dexterity scores of gloves obtained from ASTM and Minnesota tests, and mean of mean dexterity scores.

The mean dexterity score obtained from the Minnesota test and the Bonferroni test results (Table 2.4) suggest the order of gloves, as: $fabric < gel4 < rubber < gel2 < air2 < gel3 < hybrid < gel1 < gel5 < air1$. *Fabric*, *gel4*, *rubber*, *gel2*, *air2*, *gel3* and *hybrid* gloves do not show significant differences with each other, but their dexterity scores are considerably different. The results suggest no significant differences between *air1* and *gel5*, and *gel1* and *hybrid* (Table 2.4), although the dexterity score of *air1* glove is notably higher than that of *gel5*. Gloves within the same group show relatively smaller differences in manual dexterity score, which are statistically not significant. Subsequently, these gloves were ranked into three groups, shown as I, II and III in Fig. 2.6b, in the ascending order of dexterity score. It is shown that *hybrid* glove may lie in any of the three groups, since it has no significant difference with all the other gloves, while the *gel3*, *air2*, *gel2*, and *rubber*

gloves can be considered either in group I or group II. Moreover, *gell* and *gel 5* can be classified within either group II or group III.

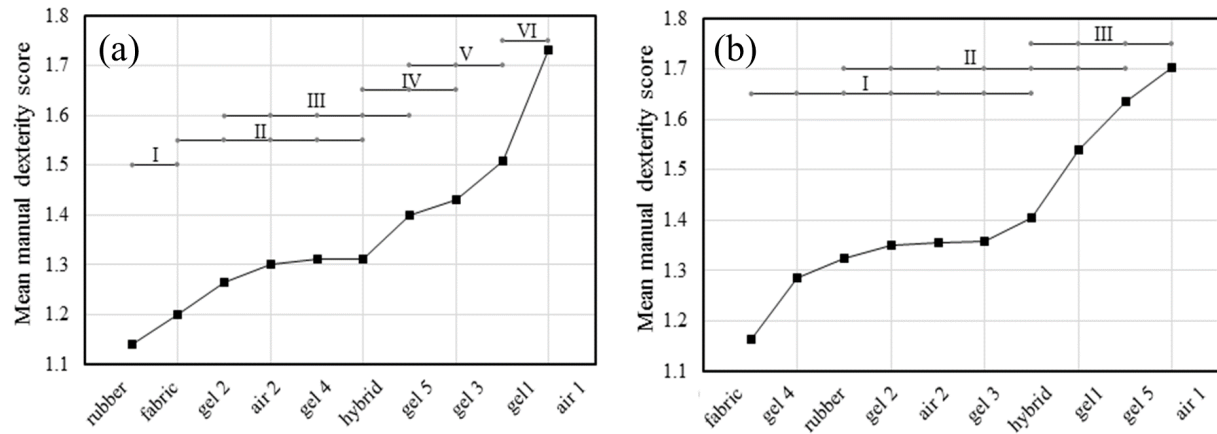

Figure 2. 6: Grouping of gloves based on mean manual dexterity score and Bonferroni tests: (a) ASTM test; and (b) Minnesota test (the gloves within the same group do not exhibit statistically significant difference among them).

2.4 Discussions

The results of this study showed that the wearing of AV gloves produces a significant impairment of manual dexterity, as reported in studies on protective gloves. The extent to which gloves impaired dexterity, however, differed with the type of glove worn and the task performed (test method). Manual dexterity is defined as the ability to integrate precision and speed with finely coordinated movements of the arm, hand and fingers. Post Hoc analyses of data show that the glove type yielded significant difference on manual dexterity. Although the test method had no statistically significant difference on manual dexterity, Minnesota test showed lower sensitivity for discriminating the gloves on the basis of manual dexterity score compared to the ASTM test.

2.4.1 Hand performance

The *gell* gloves revealed greatest variability in completion time in both methods, as shown in Fig. 2.2a and 2.2b, which is likely due to its bulky design. The glove is designed with leather covering with seams external to the fingers leading to very wide fingers regions (Table 2.2). The width of the index finger of *gell* gloves is 38.5 mm, which is only smaller than that of the *air1* (40.3 mm) among the selected gloves. A study on mechanics of tactile sense of human fingertips has reported that average width of the index finger lies in the 16-20 mm range for most adults [122]. Excessive width of the fingers' sections together with very stiff seams of both of these gloves caused considerable extra space around the fingertips. The *air1* glove with very wide fingers sections

revealed lowest manual dexterity with highest variability among the selected gloves, followed by the *gel* glove in both the methods (Figs. 2.2c and 2.2d). The results are also consistent with the completion times. The seam-to-seam width of the index finger section of the selected AV gloves ranged from 30.0 to 40.3 mm, while that of the *fabric* glove was 28.6 mm. The *rubber* glove, with smallest index finger width, provided superior fit and manual dexterity among the AV gloves. Moreover, the elasticity of this glove provided a tighter fit, which contributed to finger dexterity superior to even the *fabric* glove, as assessed from the ASTM test.

The performance with the *fabric* and *rubber* gloves is similar to that with the bare hand in terms of manual dexterity score and number of drops, as shown in Figs. 2.2c and 2.2d and 2.4. The superior dexterity of these gloves is also attributed to their very thin design. The thickness of the *rubber* glove (1.5 mm) is lowest among all the AV gloves, which is only slightly higher than that of the *fabric* glove (1.1-1.2 mm). Unlike all the other gloves, these gloves do not contain additional layers of vibration isolation material. The two test methods, however, yield considerable differences in manual dexterity of *rubber* gloves (Fig. 2.5). The ASTM method provided better dexterity of the *rubber* glove than the conventional *fabric* glove, while an opposite trend was evident from the Minnesota test. This is due to sticky surface of the *rubber* glove, which facilitated the grasping of the small size pins, and thereby enhanced finger dexterity in the ASTM F2010 test. The elasticity of the *rubber* glove material, however, imposed relatively higher hand strength demand to overcome the glove stretch, while turning the discs in the Minnesota test. Participants reported fatigue while performing the desired task with the *rubber* gloves in the Minnesota test, which likely contributed to relatively poor hand dexterity compared to the finger dexterity. Owing to elasticity of the material, low thickness and good fit, the rubber glove showed significant differences in finger dexterity, obtained from the ASTM test, with respect to all the AV gloves (Tables 2.4).

Although the rubber glove is specified as an AV glove; only limited vibration isolation is expected from viscoelastic properties of the thermoplastic rubber. The gloves with air and gel vibration isolation material layers provide effective attenuation of tool handle vibration transmitted to the palm, up to about 20% for vibration in the medium frequency range (<200 Hz) and up to about 45% for high frequency tools vibration (>200 Hz) [3]. Such gloves, however, provide only minimal attenuation of handle vibration transmitted to fingers of the hand. Hamouda et al. [5] experimentally investigated vibration attenuation performance of four different gloves including three AV gloves (air, gel, and hybrid), and concluded that air and hybrid gloves could provide some

degree of attenuation of vibration transmitted to the index and middle fingers compare to the bare hand. The additional vibration isolation materials in AV gloves, however, contribute to higher glove thickness and width around the fingers, and thereby loss of manual dexterity. An AV glove design with a tighter fit around the fingers however could help achieve improved manual dexterity while preserving effective vibration attenuation property.

Air1 and *air2* gloves comprise the same air bubble vibration isolation material, while significant differences in manual dexterity score were obtained between them in both the methods (Figs. 2.2c and 2.2d, and Tables 2.4 and 2.5). This is due to considerable differences in their design and thickness, although both the gloves provide comparable vibration isolation. The thickness of *air2* glove in the finger's region (6.7 mm) is lower than that of the *air1* glove (7.2 mm). The *air2* glove consists of softer (pearl leather) in the working surface, while *air1* is designed with relatively stiff cow leather. Same stiff leather is also employed in the hand dorsum of the *air1* glove, while a more flexible nylon fabric is used in *air2* glove, which provided relatively greater flexibility for the fingers and thereby better manual dexterity. Additionally, *air2* has exactly the same covering material as *hybrid* glove. These two gloves thus showed no significant difference between them in terms of manual dexterity (Figs. 2.2c and 2.2d, and Tables 2.4 and 2.5), although *hybrid* glove employs different vibration isolation materials in the palm (air) and fingers (gel) regions. Moreover, the *hybrid* glove is relatively thinner (5.7 mm) compared to the *air2* glove thickness in the index finger region.

Furthermore, considerable differences were observed between manual dexterity assessed using two methods for the *gel5* glove, which also revealed relatively poor dexterity (Fig. 2.5). This glove is a relatively heavy and stiff design compared to others since it is made of two gel layers covered by stiff pigskin leather on the palm as well as hand dorsum. This impeded the fingers flexibility and thus the manual dexterity. The results suggest that high stiffness of the glove covering in dorsum of the hand may impede the fingers movement at metacarpals and thus adversely affect manual dexterity. The number of drops observed with *air1*, *air2* and *hybrid* gloves were also comparable in both the methods (Fig. 2.4a), which is likely due to similar texture of the glove material on the palm side. Since vibration isolation material is integrated in the palm side of the hand only, the use of more flexible material in dorsum of the hand could improve manual dexterity while ensuring good vibration attenuation performance.

Hamouda et al. [3] evaluated the performance of 12 different AV gloves, comprising different air, gel, hybrid and gel-foam vibration isolation materials, on the basis of handle vibration transmission to the palm and fingers of the gloved hand, together with reduction in the grip strength. Five of the gloves employed in this study are identical to those used in the reported study, namely, *air1*, *air2*, *gel2*, *hybrid* and *gel5*. The study showed superior vibration attenuation performance of all the air and hybrid glove designs compared to the gel and gel-foam gloves in both the mid- and high-frequency ranges, defined in the standardized test method [11]. The *gel2* glove, however, was an exception, especially in the high frequency range. While its vibration attenuation performance in the mid-frequency range (<200 Hz) was comparable with the air and hybrid groups of gloves, it revealed greatest attenuation of high frequency handle vibration (>200 Hz) transmitted to the palm, index and middle fingers amongst all the gloves considered. Among the AV gloves considered in this study (excluding *rubber*), *gel2* demonstrated best finger dexterity as assessed from the ASTM test. This suggests that it would be feasible to design AV gloves with good vibration isolation as well as manual dexterity performance. Further studies would be desirable to investigate correlation between vibration isolation and manual dexterity performance of AV gloves.

In addition, the effect of glove thickness on manual dexterity was attempted (Table 2.5), even though the thickness effect is believed to be coupled with the varying glove construction and vibration isolation materials. The results, however, suggested reasonably good correlations between the manual dexterity score and the glove material thickness in both the methods ($r^2=0.61$ to 0.77). It could be seen that the thinnest glove (*rubber* and *fabric*) performed the best and the thicker gloves (*gel3*, *air1* and *gel5*) performed poorer. This is consistent with the reported studies [123]. The AV glove considered in the study are generally very thick. The thickness in the index finger section ranged from 4.1 mm to 8.2 mm, which was not considered sufficient to study uncoupled effect of the glove thickness. The remaining gloves (*gel1*, *gel2*, *gel4*, *air2* and *hybrid*) were similar in thickness, although seams in the liner of the *gel1* glove and stiffness of covering material had the potential to adversely affect the hand performance. Additionally, hand size and finger length showed no significant differences (Table 2.4), which is consistent with the previous studies [123].

The number of drops is considered to be related to the texture of the working surface of the AV gloves. There existed a weak positive correlation between manual dexterity score and the number of drops in the ASTM test, which could not be observed in the Minnesota test (Table 2.6). This suggests higher sensitivity of the ASTM test in view of number of drops than the Minnesota

test. The gloves within group A were associated with relatively higher number of drops than those in group B in both the methods, which may be related to texture of the working surface. The drop rate was higher in the ASTM test than in the Minnesota test (Fig. 2.4b). This is likely due to small size and smooth surface finish of the pins used in the ASTM test.

ASTM F2010 test method is intended to provide a quantitative measurement of the effect of gloves on manual dexterity by comparing the times required to perform a simple task with and without gloves. This test method is used to evaluate the dexterity of dominant hand by picking up small objects between the thumb and index finger. It does not address all the effects of glove use on hand functions such as grip and tactilely. The Minnesota test, on the other hand, is a frequently administered standardized test for the evaluation of a subject's ability to move small objects across specified distances. This test is used to measure a subject's simple but rapid eye-hand coordination as well as arm-hand dexterity. Minnesota test best represents overall manual dexterity because it involves both fine finger and whole hand dexterity and it is a two-handed test. In general, both tests measure gross motor skills, which involve the movement of large musculature and a goal where the precision of movement is not as important to the successful execution of the skill as it is for fine motor skills. Comparing with Minnesota test, ASTM F2010 test revealed greater sensitive for screening of these AV gloves (Tables 2.3 and 2.4) and relatively higher drop rate (Figure 2.4b).

The gloves considered in the study may be ranked into different groups on the basis of mean manual dexterity scores obtained from the ASTM and Minnesota tests, and the results obtained from the Bonferroni tests (Fig. 2.6). Gloves within the same group showed no significant difference among them. Using the results obtained from the Minnesota test, the gloves were ranked in three different groups, although some of the gloves may lie within more than one (Fig. 2.6b). For instance, the *hybrid* glove may fall in any of the three identified groups. The ASTM method, on the other hand, suggested six possible groups of the gloves considered (Fig. 2.6b).

Comparisons of results in Figures 2.6a and 2.6b showed greater sensitivity of the ASTM method in discriminating the gloves compared to the Minnesota method. The results thus cannot be considered to provide decisive guidelines for selecting gloves with enhanced dexterity performance, and suggest the need for further investigations using alternate methods and perhaps greater subject sample size. Although no significant differences were observed between *air1* and *gel1*, between *rubber* and *fabric*, and between *gel5* and *gel3* gloves in both the test methods, the rankings of *rubber*, *gel5* and *gel3* gloves seem to change with the test method. *Gel5* shows hand performance similar

to the *air1* and *gell* gloves in the Minnesota test, while comparable dexterity scores were obtained for *gell* and *gel3* gloves in the ASTM method, which were significantly different with respect to *air1* glove. The *rubber* glove shows better manual dexterity in ASTM test when compared to the Minnesota test.

2.4.2 Design guidelines for AV glove

It is important to design AV gloves so as achieve effective anti-vibration property while preserving hand performance and grip strength. The anti-vibration property of the AV gloves, however, has been mostly emphasized thus far, which has contributed to designs of effective vibration isolation materials and reliable measurement methods [5, 68, 74]. A few studies have also shown adverse effects of AV gloves on the grip strength demand among the power tools operators [3, 99, 100]. The manual dexterity of AV gloves, however, has been neglected, which is vital for promoting the usage of AV gloves at the workplace. The results obtained in this study suggest further efforts in order to formulate design guidance for AV gloves with improved overall performance. These include:

- (a) optimal thickness of vibration isolation materials used in the fingers region so as to improve fingers dexterity while preserving isolation of high frequency vibration;
- (b) different vibration isolation materials in the palm and fingers sections should be considered for improved hand performance and vibration isolation, although the screening criteria defined in ISO 10819 does not permit the use of different materials;
- (c) the flexibility of the glove material in the dorsum of the hand could help achieve greater finger dexterity;
- (d) the use of high stiffness leather coverings tends to limit hand motion and thus affects hand dexterity in an adverse manner;
- (e) soft covering material in the working surface with non-slip texture could facilitate more precise grasping of smaller objects;
- (f) fitness of the glove to the hand must be ensured by minimizing protrusions of the glove beyond the fingertips, while the seams should be limited to interior of the glove.

2.5 Conclusions

All the gloves impeded dexterity when compared to bare-handed performance, while all the AV gloves revealed higher dexterity scores compared to the conventional glove. Moreover, the main effect of glove type showed significant differences on manual dexterity. The interaction effect of

glove type and test method also revealed significant difference on manual dexterity. The selected glove types were ranked in four and three levels for ASTM and Minnesota test, respectively. The *air1* glove revealed the worst dexterity among all the glove types considered, followed by *gel1* and *gel5*. The *fabric* and *rubber* gloves showed best manual dexterity with both the test methods. The remaining five types of gloves (*gel3*, *air2*, *hybrid*, *gel2* and *gel4*) did not have significant difference among them with regard to manual dexterity and showed moderately better performance. A good correlation was observed between the two methods, ASTM test and Minnesota test, which was statistically significant. However, the Minnesota test showed lower sensitivity than the ASTM test in term of manual dexterity. A good correlation was also observed between the glove thickness and manual dexterity score obtained with both the methods, while there was nearly no correlation between the hand size, length of finger and the manual dexterity. A moderate correlation between the glove thickness and the number of drops was also seen in both the test methods. The number of drops was considered to be related to the texture of the working surface of the gloves. Additionally, a moderate correlation between the number of drops and manual dexterity score was evident in the ASTM test, which was not evident in the Minnesota test.

CHAPTER 3: RELATIONSHIP AMONG HAND FORCES IMPARTED ON AN VISCOELASTIC HAND-HANDLE INTERFACE

3.1 Introduction

The risk of hand-arm vibration syndrome among hand-held power tools operators is related to mechanical coupling of the hand with the vibrating tool handle apart from the nature of HTV exposure. The HTV exposure is generally assessed using frequency-weighted acceleration of the vibrating tool handle and the dose-response relationship defined in ISO 5349-1 [19], while the effect of hand-handle coupling force is not considered. It has been reported that the magnitude of the coupling force imparted on a vibrating tool handle affects the severity of the HTV exposure and hand-wrist cumulative trauma disorders [124-126]. Hand-handle coupling force has been defined as the sum of hand grip and push forces imparted on a tool handle [127]. There is evidence that reducing the coupling force is likely to decrease the injurious effect of exposure to HTV. Moreover, greater grip and push forces yield increased electrical activities of the flexor carpi ulnaris and finger-flexor muscles, which may adversely affect peripheral circulation of the fingers [111, 128, 129].

Considering the important effects of hand-handle coupling force, the CEN/TR 16391 [126] has defined an additional weighting to account for the effect of hand-handle coupling force on vibration exposure risk. The significance of coupling force on the handle vibration has also been emphasized in ISO 5349-2 [1], which recommends measurements of HTV under different levels of coupling force applied to the tool handle. A definite relationship between the coupling force and the HTV exposure, however, does not yet exist. The development of methods for reliable measurements of hand-handle coupling forces is thus vital to seek such a relation to assess the effect of hand forces on vibration exposure. Moreover, a few studies have established that AV gloves, widely used for attenuation of HTV significantly alter the hand-handle contact force and impose greater demand on the hand forces and thus higher risk of hand-arm musculoskeletal disorders such as hand tendonitis, strained muscles, and carpal tunnel syndrome [100, 102]. These have employed the measurements of grip strength via instrumented handles and hand force dynamometers [96, 130]. This further suggests the need for development of an effective measurement system for quantifying the hand-handle contact forces developed at the flexible gloved hand-handle interface.

Although the significance of coupling force and grip strength on the hand-arm vibration dosage and potential injury risk has been widely recognized, the measurements of coupling force

on power tools have met only limited success [113, 131, 132]. This is due to lack of reliable methods for measurements of forces developed at the tool handle-hand interface, especially for field applications. The measurements of grip and push forces, and thus the coupling force, imposed on handles have been conducted via instrumented cylindrical and elliptical split handles in conjunction with a force plate in a laboratory setting [114, 133]. Cylindrical instrumented handles or dynamometers have also been applied for measurements of grip forces on bicycle handles [134] and grip strength [135, 136] to study the effects of handle size and shape [137-139]. The cylindrical or elliptical cross-sections, however, do not represent the geometries of many tool handles. The grip force measured with such handles may not accurately describe that applied to a real tool handle [100]. Moreover, applications of an instrumented handle and force plate for measurement of coupling force on a tool implies not only high cost and design complexities, but also possible ergonomic impairments.

ISO 15230 [127] provides definitions of hand-handle coupling and contact forces and guidance for measurements of these forces and related parameters using a flexible pressure-sensing mat. A few studies have explored feasibility of thin-film and flexible pressure sensing systems that can be applied to handles with varying cross-section and curvature for measurements of contact pressure and contact and coupling forces. Fukubayashi and Kurosawa [140] used the Fuji Film Prescale Pressure Measuring System to measure contact area and contact pressure distribution in the knee. This method is widely being used in orthopedics and bioengineering research, although the method cannot provide real time measurements due to complex signal processing and analyses. Semiconducting, capacitive and resistive thin film sensors, comprising pressure-sensitive capacitors and resistors, respectively, have been successfully used to measure hand-handle contact forces under static conditions [108, 112, 141-144]. Bachus et al. [112] compared the performance of measurement systems employing pressure-sensitive Fuji film and resistive sensors, and concluded that the resistive sensing grid yields more accurate measurements of contact area and pressure than the Fuji film. The capacitive pressure sensing grids, developed by Novel GmbH (Germany), have been applied to cylindrical and elliptical handles to quantify hand-grip pressure distributions and relationships among the grip, push and contact forces as a function of the handle size [108, 114]. Lemerle et al. [17] used a hand sensor comprising capacitive pressure sensors to measure the grip and push forces on power tools' handles.

Aforementioned studies have clearly demonstrated the feasibility of capacitive pressure-sensors for reliable measurements of hand-handle interface pressure distributions and coupling forces. The measurement system, however, is not considered to be well-suited for field applications due to its very high cost. Moreover, the capacitive sensors are known to be relatively fragile and may incur damage and/or failure during field applications. Alternatively, a few studies have explored low cost force sensing resistors (FSR) for hand-handle interface force measurements. Seo et al. [133] used a resistive pressure-sensing matrix, developed by Tekscan Inc. (USA), to establish a relationship among the grip and normal forces, and contact area for cylindrical handles and its dependence on the handle and hand sizes. The I-scan software, developed by Tekscan, permits equilibration of sensels within a sensing matrix via appropriate correction factors that are identified by subjecting the sensors to uniform pressure [145]. It has been reported that equilibration of the resistive sensing systems could effectively reduce the individual variance of the pressure-sensing elements [142]. Rossi et al. [146] applied resistive pressure sensors to study the influence of handle diameter on the hand forces. Kalra et al. [113] applied two low cost thin film resistive sensors on opposite sides of a tool handle in the grip direction to measure the coupling force at the hand-handle interface under static and dynamic conditions. While the individual sensors showed good linearity and repeatability of measurements, considerable drift and notable differences were reported among different sensors [142, 147-150].

In the aforementioned studies, the hand-handle pressure measurement systems have been, invariably, applied for measurements of coupling force and contact force/pressure at the rigid handles. A tool handle enclosed by a vibration isolation material, however, constitutes an elastic hand-handle interface, which may affect the distribution of contact pressure and thus the force. Moreover, through measurements of contact force imposed by a gloved hand on rigid handles, it has been shown that AV gloves affect operators' grip strength in an adverse manner, suggesting higher musculoskeletal loads with an AV glove [3]. This may be due to viscoelastic properties of the gloved hand-handle interface, while measurement of contact force at an elastic interface has not yet been attempted. Effect of a viscoelastic AV glove on the grip strength can be evaluated through measurements at the interface of the hand and the glove. This will necessitate applications of the force/pressure-sensing grid inside the glove between the hand and the glove. Development of a hand sensor that can be applied to an elastic interface or within the AV glove can not only help

quantify the effect of viscoelastic interface on the grip strength but also a relationship among the hand forces applied to tool handles with elastic material coverings such as handle grips.

In this chapter, a hand-force measurement system for acquiring elastic hand-handle interface force/pressure is developed and evaluated. The hand sensor, comprising thin flexible pressure-sensitive resistive sensels, could be applied for measuring the contact force distribution at the elastic hand-handle interface and may be inserted into the AV glove to study the effect of AV gloves on the grip strength. The static properties of the hand sensor in terms of linearity, hysteresis and repeatability are evaluated under local as well as global loading of the sensor on a flat surface. The feasibility of the hand sensor applied to curved surface is evaluated by applying it to an instrumented rigid handle capable of measuring hand grip and push forces. The contact forces developed at the rigid and elastic hand-handle interface are measured under different combinations of hand grip and push forces, and the data are analyzed to establish relationships among the grip/push and contact forces using the multiple linear regression analysis. More details of this analysis method could be found in Appendix B. The effectiveness of the hand sensor for measurements of contact force between the hand and an AV glove is further evaluated.

3.2 Hand Sensor Design and Assessments

The hand sensor was designed for measurement of contact force distribution at the flexible hand-handle and hand-glove interfaces. The sensing matrix was based on relatively low-cost pressure-sensitive resistive sensels. The sensor was designed so that it could be mounted on the hand surface to capture the contact force distributed at each digit of the hand and in the palm region. The sensor could also permit measurement of the contact force of the gloved hand, when an AV glove is worn over the hand with the sensor. The dimensions of the palm and fingers regions were chosen to ensure its fitting to the hand size of 10 in accordance with the EN 420 standard [121]. The sensing matrix was designed with five sensitive strips for accommodating five digits of the hand, which were connected to a sensing grid in the palm region, as shown in Fig. 3.1(a). The sensor was fabricated by Tekscan Inc. (Tekscan, South Boston, MA, USA), which also provided the data acquisition (DAQ) system together with the I-Scan software [145]. The hand sensor is made of a matrix of pressure-sensing elements (denoted as ‘sensels’) sandwiched by two layers of thin-film sheets, as pictorially illustrated in Fig. 3.1(b). The 0.1mm thick flexible sensing matrix was printed on a polyester sheet both horizontally and vertically [151]. The intersections of these horizontal and vertical arrays created sensels. Each sensel thus contained a pair of intertwined conductors

enclosed by an adhesive layer coated with pressure-sensing ink, which formed the effective sensing area. The sensing area could measure the change in sensel resistance in response to an applied pressure, which were acquired and processed in the I-Scan software to determine the distributed contact force. The sensor was designed with a total of 372 sensels including 196 sensels in the palm sensing grid, 36 sensels within each of the thumb, and index and ring finger regions, and 39 and 30 sensels in the middle and little fingers regions, respectively. The effective area of each sensel was 0.46 cm^2 , while the total effective sensing area of the sensor was 171.98 cm^2 .

Apart from the above, the sensor design involved considerations of other factors. These included the sensor flexibility for its applicability to curved rigid as well as flexible handle surfaces with minimal interference with the hand/finger's movements, and low cost and sufficiently robust for applications in real tools handles. The software also computes the overall contact force, force developed within the individual regions, mean and peak contact pressure within each region, and the center of pressure. Owing to wide variations in the hand-handle contact pressure [108], good sensitivity of the sensing matrix to local as well as overall loading constituted another important design criterion. The studies reporting pressure distributions at the elastic and rigid seats have shown that the peak contact pressure observed at an elastic interface is substantially lower than that at the rigid interface [108]. The I-Scan software permitted scalable gains to ensure nearly uniform sensitivity of the measurement system over different desired ranges. The maximum pressure measurement range of the hand sensor, 0 to 2.76 bar (40 psi), corresponded to the lowest sensitivity level. A higher sensitivity level could be chosen for a lower pressure range that was expected for a flexible interface. Moreover, the sampling frequency of the I-Scan system could also be varied from as low as 0.015 Hz to a maximum of 730 Hz.

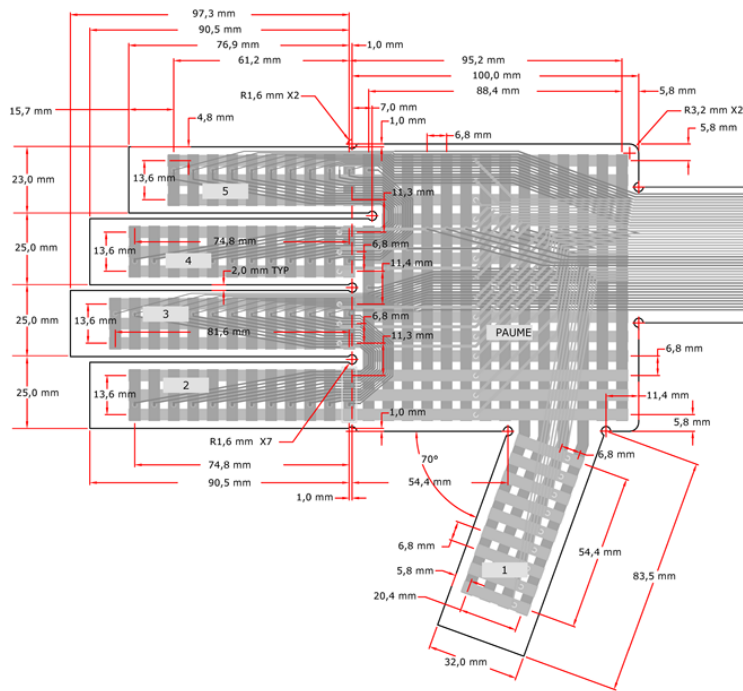

(a)

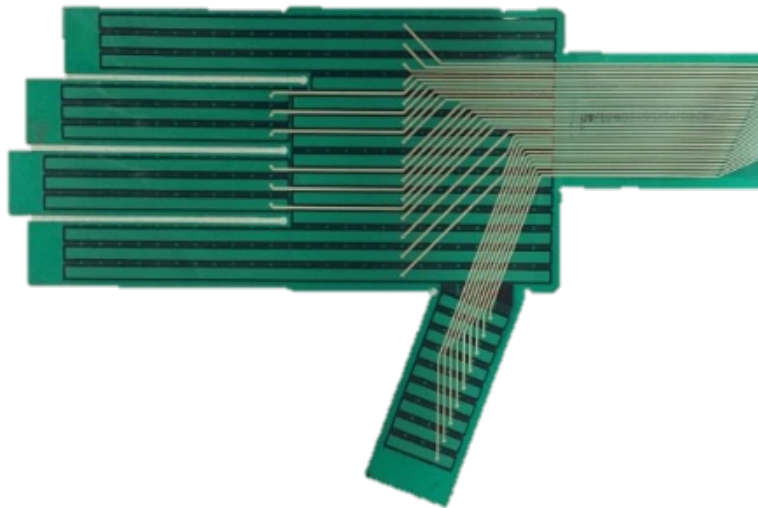

(b)

Figure 3. 1: (a) Dimensions of the sensing grids in the fingers and palm regions; and (b) pictorial view of the hand-sensor.

3.2.1 Hand sensor calibration

The I-Scan software expresses the change in resistance of each sensel in terms of a digital output ranging from 0 to 255 (raw sum). The relationship between the raw sum and the applied force within a selected measurement range was established via calibrations using the two-point power law

method, as recommended in [145]. The sensor calibration was performed by subjecting all the sensing elements to a uniform controlled pressure via an air bladder. The sensor was pre-conditioned prior to the calibration by repeatedly loading and unloading the sensor with a uniform peak pressure of about 2 bars (five times). Subsequently, a pressure sensitivity gain was selected for the desired measurement range to ensure good resolution of the measurement and to avoid sensels' saturation. The two different measurement ranges were considered for the rigid and flexible hand-handle interface conditions. The mean peak contact pressure imposed by the bare hand grasping a 40 mm diameter rigid handle with 50 N grip and 75 N push forces has been reported to be in the order of 1.41 bars [108]. The measurement range of 0 to 2 bars was thus selected for measurements with the rigid handle. The measurement range for the elastic hand-handle surface was estimated as 0 to 1 bar. The sensor calibrations were thus performed for these two measurement ranges using appropriate sensitivity gains.

The resistive sensors may exhibit variabilities due to non-uniformity of the pressure-sensitive ink. Maurer et al. [142] reported that equilibration of the sensing system can effectively reduce the effect of variance among the individual pressure-sensing elements. Through equilibration, the I-Scan system computes and applies appropriate correction factors to compensate for such variations. The equilibration of the sensels was thus performed by applying uniform pressures of 0.5, 1 and 1.5 bars in a sequential manner. Subsequently, the hand sensor was calibrated via two-point power law method. Two different pressures, 20% and 80% of the maximum load, were applied to the hand sensor via the air bladder. Each pressure loading was held for a duration of 30s so as to achieve steady-state loading of the sensors by the air bladder. Relationship between the raw sum and the force was established in the form of $y=ax^b$ for the two measurement ranges considered.

The measurement accuracy of the hand sensor was subsequently evaluated under different uniform pressures (0, 0.5, 1, 1.5 and 2 bars). The applied force was computed for each pressure loading on the basis of the effective sensor area (171.98 cm^2). The distributed force signals were recorded as a movie for a duration of 30 s at the rate of 1,000 frame/s for each input pressure. The selected period was consistent with that used during the calibration. Table 3.1 compares the mean measured force obtained from the measured data during the 30 s interval with the computed force for each pressure loading. The table also presents the residual error between measured and applied force. The results show peak residual error of 2.2%, which suggests that the sensor can measure the

overall force accurately when applied uniformly on a flat surface. The error is likely caused by slight drift in the measurement, which has also been reported in studies on similar sensors [152, 153]. The time-dependency of the measurement was examined by monitoring the measured force signal under 1 bar uniform pressure (applied force=1720 N) for a duration of 60 s. The measurements showed drift in the mean force 1.7%, 2.9% and 4.6%, respectively, over the intervals of 15 s, 30 s, 60 s, when compared to the applied force. These suggest that the sensor response exhibits sufficiently long time constant for accurate measurements of the static and dynamic hand force.

Table 3. 1: Comparison of mean measured and applied force magnitudes

Applied pressure (bar)	Applied force (N)	Measured force (N)	Residual error
0.5	860	852.5	-0.9%
1.0	1720	1740.6	1.2%
1.5	2580	2636.2	2.2%
2.0	3440	3498.8	1.7%

3.2.2 Static characteristics of the hand sensor under global and local loading

The static characteristics of the hand sensor were evaluated in terms of linearity, repeatability and hysteresis of measurements under static loads applied to the entire sensor placed on a flat surface. The entire sensor area was subjected to loads of 14.8 N, 36.4 N, 85.4 N, and 140.3 N in a sequential manner through a flat aluminum plate via a loading indenter. An elastomer was also placed between the loading plate and the sensor to achieve a nearly uniform contact with the sensor (Fig. 3.2). The 8mm thick elastomer was cut in the shape of the sensor in order to apply uniform loading of the fingers and palm sensing grids.

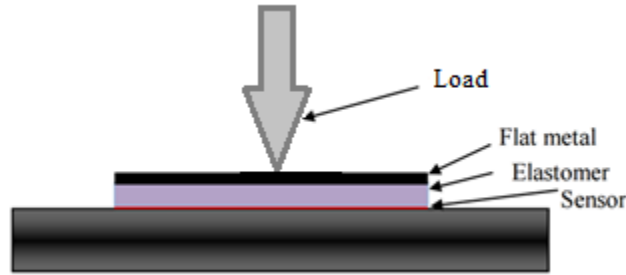

Figure 3. 2: Loading of the hand sensor through an aluminum plate and elastomer.

Before applying the load, the hand sensor was zeroed to remove the force due to the elastomer and the aluminum plate. The sensor load was then gradually increased to 140.3 N and decreased to 0 N, and the sensor signal was recorded for an interval of 30s under each discrete load. The measurements for each loading and unloading cycle were repeated 3 times. Figure 3.3 illustrates the variations in the measured force with the applied force. The linearity of the measurement was evaluated from the means of the loading and unloading curves obtained during the three loading/unloading cycles. The results revealed strong linearity of the hand sensor with r^2 in excess of 0.99, while the peak hysteresis was below 6%. The coefficient of variance (CoV) of the mean was obtained as 1.5%, which suggested good repeatability of the measurement.

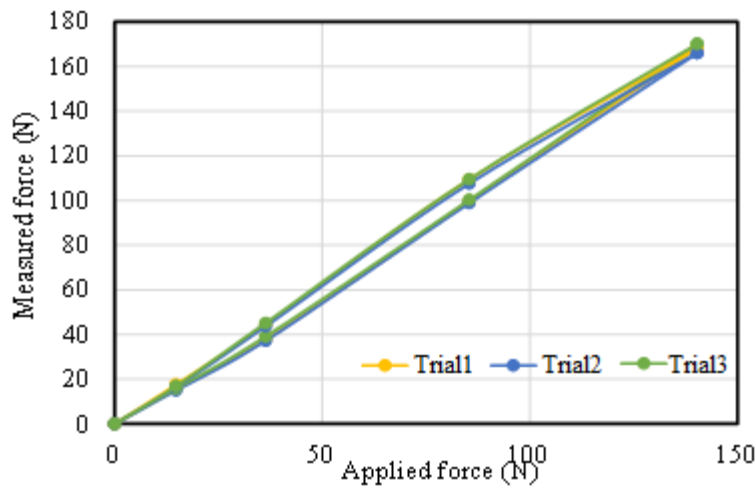

Figure 3. 3: Variations in measured force with the applied force during three loading and unloading cycles.

The effectiveness of the hand sensor in capturing a locally applied force was also evaluated under loads applied to selected local regions, which would be expected for the hand grasping a handle. The measurements were performed by subjecting the palm, thumb, and index and middle

fingers sensing areas to a constant load in a sequential manner. A constant load of 21.56 N was applied to each finger region, while the palm sensing area was subject to a load of 49 N. The loading was applied by a flat aluminum plate and the elastomer, as in the case of global loading (Fig. 3.2). The elastomer was sized appropriately to ensure loading of the selected region alone. Each measurement was repeated 3 times. Table 3.2 summarizes the mean, standard deviation and measurement error for each locally loaded region. The results show measurement errors below 2% and peak CoV below 5%. It is thus deduced that the hand sensor is equally effective for accurate measurements of locally applied loads.

Table 3. 2: Variability in the measurement under locally applied loads

Applied region	Applied force (N)	Measured force (N)			Mean	Standard	
		Trail1	Trail2	Trail3		deviation	Error (%)
Thumb	21.56	22.69	20.75	21.90	21.78	0.80	1.03%
Index finger		20.98	21.08	21.35	21.14	0.16	-1.96%
Middle finger		21.89	20.54	21.22	21.21	0.55	-1.6%
Part of palm	49	49.6	47.6	48.5	48.6	0.8	-0.9%

3.3 Measurements of the hand-handle contact force

An experiment was designed to evaluate effectiveness of the hand sensor to measure hand-handle contact force considering three different interface conditions. These included: (i) the bare hand grasping a rigid handle (RH); (ii) bare hand grasping the handle enveloped by a viscoelastic material (FH); and (iii) a gloved hand grasping the handle (GV). The primary motivation for the experiment derives from the need to define relationships between the grip and push forces, and the contact force for the rigid and flexible hand-handle interfaces. Moreover, the direct measurement of contact force developed by the gloved hand will facilitate the assessment of the effect of AV gloves or viscoelastic handle coverings on the grip strength, which has been widely reported on the basis of indirect measurements [132, 133]. The experiment for each interface condition involved nine combinations of grip (10, 30, and 50 N) and push (25, 50, and 75 N) forces. Five healthy right-handed male subjects were recruited for the study with hand size of 9 in accordance with the EN 420 standard [121]. None of the participants had prior experiences in working with hand tools. The aim of the study and experimental procedures were described to each participant together with his

rights and responsibilities. Each participant consented to the experimental protocol, which had been approved by the Human Research Ethics Committee of Concordia University.

The calibrated hand sensor was attached to the palm and fingers of the right hand of the participant using medical tape, as shown pictorially in Fig. 3.4(a). The contact force was initially measured for the rigid hand-handle interface to evaluate effectiveness of the hand sensor considering the reported hand forces relationships in [114, 132]. This also provided feasibility of the sensor's application to a curved handle surface. Experiments were performed with a 40 mm diameter and 140 mm long split cylindrical handle, which integrated two single-axis force sensors (Kistler 9212) for measurement of the grip force (Fig. 3.5). The instrumented handle was installed on an electro-dynamic shaker in a horizontal plane to permit gripping of the handle along the Z_h -axis using a mounting bracket. Another two force sensors (Kistler 9317b) were placed between the handle and the exciter for the measurement of the push force imparted by the hand on the handle (Fig. 3.5). Each subject was advised to grasp the handle with a desired combination of hand grip and push forces, while standing upright assuming the posture described in ISO 10819 [73], as shown in Fig. 3.4(b). The forearm was held nearly horizontal with elbow angle of 90 ± 15 degrees, and neutral wrist position, while the elbow was not permitted to touch the body. The applied grip and push forces, sampled at a rate of 4 Hz, were displayed on a computer screen mounted at the eye level of the subject, which permitted the subject to maintain hand grip and push forces near the desired combination. It should be noted that the shaker was merely used to provide a support for the test handle, since the hand forces were measured under static condition alone. Prior to the experiment, each participant was asked to perform few practices runs by randomly applying three different grip/push force combinations among the nine combinations of grip (10, 30, and 50 N) and push (25, 50, and 75 N) forces using feedback from the displayed forces.

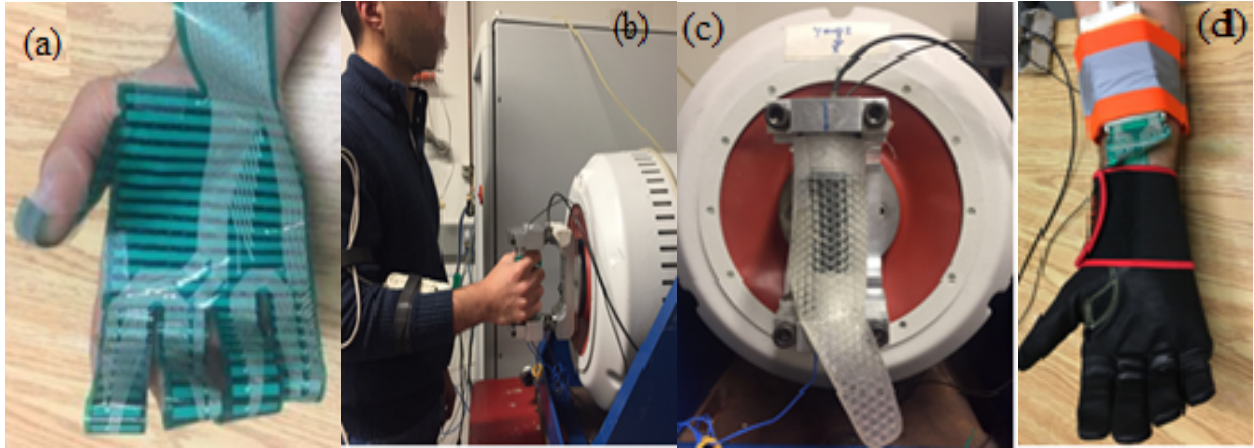

Figure 3. 4: Pictorial views of the measurement setup: a) hand sensor fixed to the hand; b) subject’s posture while grasping the handle; c) handle covered with a gel material; d) gloved hand with the hand sensor;

A total of 27 randomized trials, including three repeats, were performed for each subject. Prior to the measurements, participant was advised to hold the hand with sensor around the handle in a power grip position without making any contact with the handle. The hand sensor was zeroed to remove the residual pressure, if any. Subject was advised to grasp the handle with a desired grip/push forces combination and maintain it within a margin of $\pm 2 \text{ N}$ for a period of 30 s. The hand-handle interface contact force signal for each force combination was acquired in the I-Scan data conditioning and acquisition system. Apart from the contact force, the time-histories of the grip and push forces, obtained from the instrumented handle, were also recorded for the duration of 30 s for each trial. Three trials for each grip and push forces combination were performed to verify repeatability of the measurements. The participant was asked to relax for 1~2 minutes between the consecutive trials to avoid fatigue.

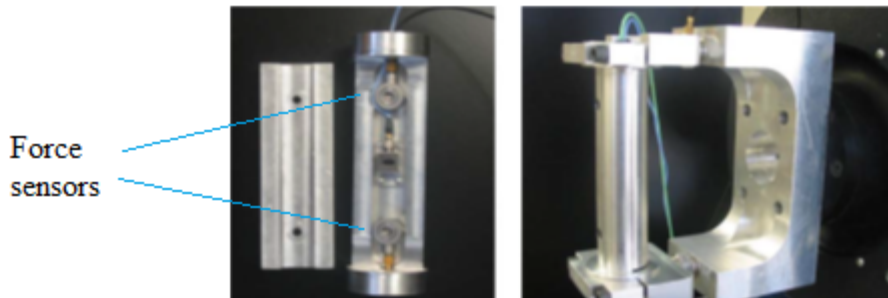

Figure 3. 5: Instrumented cylindrical handle with grip and push force sensors

Subsequently, the measurements were repeated for measurements of the contact force developed at the flexible hand-handle interface. For this purpose, a viscoelastic gel material used

in the AV gloves enveloped the handle, as shown in Fig. 3.4(c). The contact force developed at the interface was measured for different combinations of the grip and push forces. The order of the forces' combination together with the three trials was randomized, as in the case of the rigid interface.

The final series of measurements were performed with the gloved hand grasping the rigid handle with same combinations of hand grip and push forces imparted on the handle. An AV glove, made of gel material used in the elastic hand-handle interface, was used for the measurements of contact force via the hand sensor. This particular glove is considered as an AV glove as per the screening criterion defined in ISO 10819 [73]. The glove revealed vibration transmissibility magnitudes of 0.82 and 0.50 for the medium (25-200 Hz) and high (200-1250 Hz) frequency ranges in accordance with the standard [73]. The participant wore the selected glove over the hand with the hand sensor. A relatively large size AV glove was chosen so as to facilitate sliding of the glove over the hand with the sensor and to minimize damage to the sensor. Figure 3.4(d) illustrates the hand sensor inserted within the gloved hand. Subsequently, each subject participated in the measurements of contact force developed by the gloved hand for three trials of same combinations of grip and push forces in a random order.

3.3.1 Data analysis

The total contact force developed at a hand-handle interface was computed from the integration of the local pressure over the effective contact area within the I-Scan software. The effective contact area is defined as the area covered by active sensels of the sensor. A sensel is considered active, when its mean pressure exceeds the threshold value. The measurement system provided force threshold values of 0.018 N and 0.035 N, respectively, for the 1 and 2 bars pressure ranges, which were considered to provide a good compromise between the measurement accuracy and the signal noise. The total contact area is obtained by summing the areas of the active sensels, such that:

$$A_c = \sum_{i=1}^n \Delta A \quad (3.1)$$

where A_c is the total effective hand-handle contact area, $\Delta A = 0.46 \text{ cm}^2$ is the individual sensel area and n is the number of active sensels. Since the sensel area is constant, the contact force F_c is computed assuming uniform pressure over the small sensel area, such that:

$$F_c = \Delta A \sum_{i=1}^n p_i \quad (3.2)$$

Where p_i is pressure measured by the sensel i .

The acquired data were analyzed to derive the mean contact force corresponding to each grip and push force combination. The standard deviation of the mean was used to evaluate the intra-subject variability of the measurements during the three trials. A relationship of the mean measured contact force with the corresponding grip and push forces was identified using multiple linear regression analysis. A relationship of the following form, as reported in [132], was attempted for each of the interface condition:

$$F_c = \alpha_0 + \alpha_g F_g + \alpha_p F_p \quad (3.3)$$

where coefficient α_0 represents the contact force offset of the hand sensor, and α_g and α_p are the coefficients representing the contributions due to the grip force F_g and push force F_p , respectively.

It has been reported that the grip and push force coefficients, α_g and α_p , depend upon the handle diameter. The effective diameter of the handle used for measurements of contact force at the elastic interface formed by the viscoelastic material or the AV glove was considerably higher than that the nominal diameter (40 mm) of the rigid handle. The mean diameter of the handle with 5 mm thick gel material was measured as 50 mm. For the purpose of relative analyses of contact force developed at rigid and viscoelastic interfaces, the contact force obtained for the 40 mm rigid hand-handle interface was adjusted to estimate the contact force for the 50 mm handle using the diameter dependence of the force relationship defined in [132, 154].

3.4 Results and discussions

3.4.1 Contact force developed at the rigid hand-handle interface

The mean and standard deviations of the contact force measured during the three trials with different hand forces combinations revealed notable intra-subject variability in the measurements. The coefficients of variation (CoV) of the measurements ranged from 2.1% to 8.9% for the five subjects and the different hand forces combinations. Highest intra-subject variation was evident for combinations involving the highest push force ($F_p=75$ N), followed by those with the highest grip force ($F_g = 50$ N). The grip and push forces data acquired for the combinations involving the highest grip and push forces also showed notable variations in the applied forces. The high intra-subject variability was thus attributed to the subjects' inability to maintain steady hand forces under the high grip and push forces.

Figures 3.6(a) and 3.6(b) illustrate variations in the mean contact force obtained for the 5 participants as functions of the applied grip and push forces, respectively. The figures also show standard deviations of the means corresponding to each grip/push force combination as error bars.

The coefficients of variation (CoV) of the measured contact force ranged from 3.4% to 9%, which are similar to the intra-subject variations. Similar to the intra-subject variability, the data revealed higher inter-subject variations for combinations involving highest grip or push forces ($F_g = 50$ N or $F_p = 75$ N), which is also evident from the error bars in Figs. 3.6(a) and 3.6(b). Welcome et al. [114] and Aldien et al. [108] reported inter-subject variability of the contact force measurements across 10 subjects in the order of 7-18% range for the 40 mm and 48 mm diameter handles. Relatively higher variability (10-20%) was observed in the data acquired for the 30 mm diameter handle. The contact force in both the studies was measured via a capacitive pressure sensing mat. The results in Figure 3.6(a) suggest nearly linear dependence of the mean contact force on both the applied grip force, irrespective of the push force magnitude. The variations in the push force cause a nearly constant shift in the mean contact force. The magnitude of this shift is similar to the change in the push force for each given grip force, which suggests a nearly direct contribution of the push force to the hand-handle contact force ($\alpha_p \approx 1$). The mean contact force also varies nearly linearly with the push force for the given grip force, as seen in Figure 3.6(b). The change in the grip force in this case also causes a shift in the mean contact force. The rate of change of the mean contact force with the grip force, however, is substantially higher than that with the push force, which suggests a relatively higher contribution of the grip force to the hand-handle contact force.

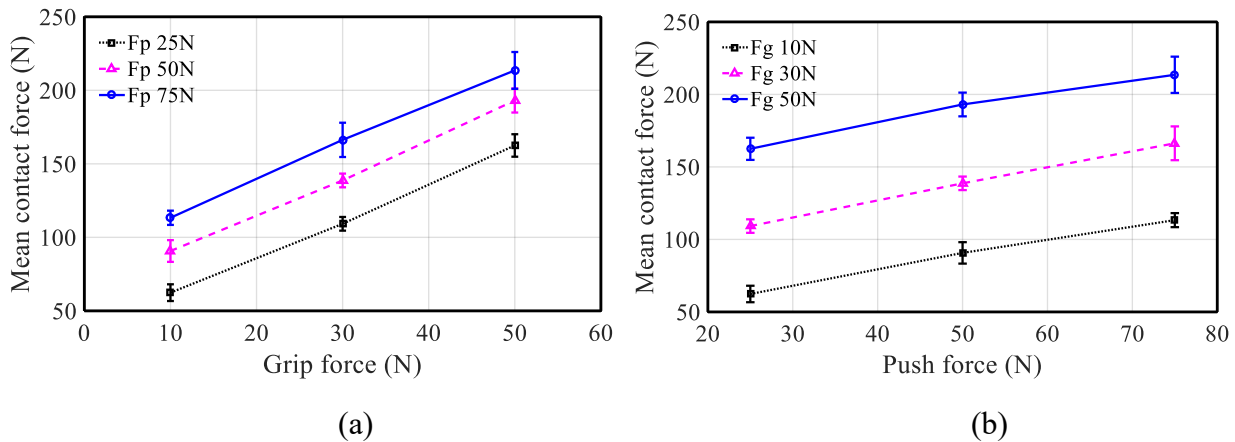

Figure 3. 6: Variations in the mean contact force measured on the 40 mm rigid hand-handle interface with: (a) hand grip force; and (b) hand push force.

A multiple linear regression analysis was performed using equation (3.3), in order to identify the grip and push force coefficients for the RH contact condition. The offset in the contact force (α_0) was set to 0, since the hand sensor signal was zeroed prior to each measurement. Correlation coefficients (r^2) for all the linear fits across the 5 subjects were greater than 0.94. Consequently,

higher order fits were deemed unnecessary. The results showed close to unity mean push force coefficient (α_p) for the five subjects with mean and standard deviation (*SD*) of 1.15 and 0.09, respectively (Table 3.3). Conversely, the grip force coefficient (α_g) varied from 2.60 to 2.92 across the subjects with a mean and standard deviation of 2.75 and 0.12, respectively (Table 3.3). The observed grip and push force coefficients are comparable with those reported in [114, 132]. Marcotte et al. [132] reported that grip and push force coefficients of the contact force range from 2.71 to 3.13 and from 0.83 to 1.17, respectively, for the 10 subjects grasping a 40 mm diameter cylindrical handle. The mean \pm standard deviation of α_g and α_p was 2.82 ± 0.27 and 1 ± 0.13 , respectively. Similarly, Welcome et al. [114] reported the mean grip and push forces coefficients of 2.87 and 1.10 for the nominal 40 mm diameter handle. Both the studies considered identical grip and push force combinations. It is thus deduced that the hand sensor design realized in this study can accurately measure the hand-handle interface contact force.

Table 3. 3: Grip and push force coefficients obtained from multiple linear regression analysis of the data for five subjects and different hand-handle interface conditions.

Hand-handle interface	Handle size	Coefficient	Subject					Mean	SD	CoV
			A	B	C	D	E			
RH	40 mm	α_g	2.74	2.63	2.60	2.92	2.86	2.75	0.12	4.4%
		α_p	1.17	1.10	1.27	1.21	1.02	1.15	0.09	7.8%
		r^2	0.98	0.98	0.97	0.94	0.95	-	-	
RH	50 mm	α_g	$\alpha(D) = -0.0496D + 4.878$ [154]					2.40	0.26	10.8%
		α_p	$\beta(D) = 0.0022D + 1.021$ [154]					1.13	0.27	23.9%
		r^2	0.99					-	-	
FH	50 mm	α_g	3.46	2.66	3.04	3.16	2.96	3.06	0.26	8.5%
		α_p	1.88	1.29	1.30	1.41	1.11	1.40	0.27	19.3%
		r^2	0.91	0.93	0.97	0.90	0.92	-	-	
GV	-	α_g	3.71	3.08	3.41	3.62	2.74	3.31	0.36	10.9%
		α_p	1.74	1.67	1.61	1.29	1.29	1.52	0.19	12.5%
		r^2	0.91	0.83	0.93	0.89	0.96	-	-	

RH- Bare hand with a rigid handle; FH- Bare hand with resilient material; GV- Gloved hand

The results suggest that the contact force developed by the bare hand grasping a rigid handle constitutes about 2.75 times the grip force. In contrast, the push force contributes almost directly to the contact force. This is due to the fact that the push force is applied over a relatively small portion of the hand surface area (upper lateral side of the palm) normal to the handle axis. The grip force, on the other hand, is developed through compensation of the axial force components applied by the palm and fingers of the hand along the Z_h -axis alone [127]. The contact area of the palm and fingers is thus substantially higher compared to that encountered for the push force. Moreover, the grip force, as defined in [127], neglects the contribution due to non-axial hand pressure on the handle surface. The relatively higher value of α_g compared to α_p accounts for the effect of the non-axial hand contact pressure on the resulting contact force.

3.4.2 Contact force developed at the viscoelastic hand-handle interface

The contact force data acquired with subjects grasping the handle covered with the viscoelastic AV material were analyzed to obtain a relationship among the hand forces, as described in Eq. (3.3). The data acquired during three trials for different subjects and grip/push force combinations revealed intra-subject variability in the 2.4% to 9.6% range. These are only slightly higher than those observed with the rigid handle. Highest variability was observed for combinations involving highest push (75 N) or grip (50 N) force, as in the case of the rigid hand-handle interface. The mean contact force obtained for the 5 subjects varied nearly linearly with the hand grip and push forces, as shown in Figs. 3.7(a) and 3.7(b), respectively. The figures also show standard deviations of the means corresponding to each grip/push force combination as error bars. The CoVs of the measured contact force ranged from 3.1% to 10.5%, which are also slightly higher than those observed for the rigid hand-handle interface (RH). The grip and push coefficients identified from the multiple regression analysis of the data acquired with each subject are summarized in Table 3.3 together with the means and standard deviations of the mean coefficients. The linear fits obtained for the 5 subjects revealed correlation coefficients (r^2) in excess of 0.9. Despite some variations between individuals, the mean grip and push force coefficients were obtained as 3.06 and 1.40, respectively, which are notably higher than those observed from the RH condition.

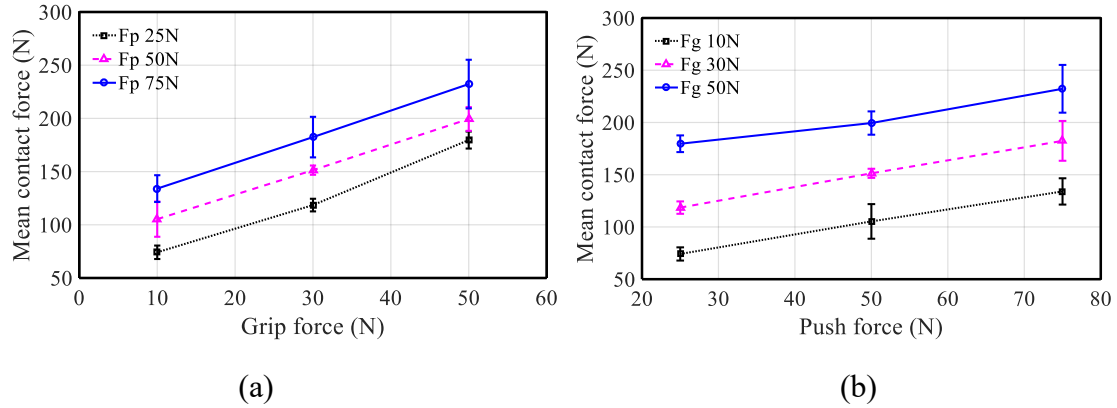

Figure 3. 7: Variations in the mean contact force measured on the elastic hand-handle interface (FH) with: (a) hand grip force; and (b) hand push force.

The results obtained for the FH condition cannot be compared with those for the RH condition, since these two conditions represent the difference in the effective handle diameter. The effective handle diameter in the FH condition was 50 mm, while that of the handle in the RH condition was 40 mm. It has been reported that a larger handle yields higher effective contact area but lower mean contact pressure. The contact force tends to decrease with an increase in the handle diameter [132]. The reported handle diameter dependency of the contact force [132] was used to obtain estimates of α_g and α_p for contact with a 50 mm rigid handle, in order to better compare the contact force with those obtained for the FH and GV conditions. The results presented in Table 3.3 suggest a relatively lower value of α_g (2.4) for the 50 mm handle compared to that for the 40 mm rigid handle (2.75). The value of α_p (1.13), however, is comparable with that of the 40 mm handle (1.15).

More pronounced differences between the RH and FH conditions are evident when α_g and α_p values are compared for the identical handle size of 50 mm. The results show a notably higher contribution of grip force to the contact force developed at the flexible interface compared to the RH condition. The grip coefficient (α_g) is about 27.5% higher for the FH condition compared to the RH condition considering the same handle size. The push force coefficient (α_p) also increased from 1.13 for the RH condition to 1.40 for the FH condition. The results suggest that grasping a viscoelastic handle interface would require higher contact force in order to achieve target grip and push forces, when compared to a rigid handle. The above suggests that for given grip and push forces grasping a handle with the viscoelastic AV material used in the study will impose nearly 28% greater grip strength demand from the subject, compared to the rigid handle. A recent study on the

grip strength performance of different AV gloves has reported a 27% to 41% reduction in the grip strength compared to the bare hand [3]. The study, however, measured the maximum grip strength of the participants with bare and gloved hands. The grip strength reduction due to a viscoelastic material covering is thus expected to vary with the viscoelastic properties of the material.

The effect of a viscoelastic interface on the contact force may also be attributed to the relatively higher effective contact area compared to the RH condition. Figure 3.8 compared the mean contact area obtained for the RH and FH conditions for the nine hand force combinations considered in the study. The FH condition leads to a substantially higher contact area, irrespective of the hand force combination. The mean contact pressure developed at a flexible interface was also higher, which leads to relatively higher contact force compared to the RH condition.

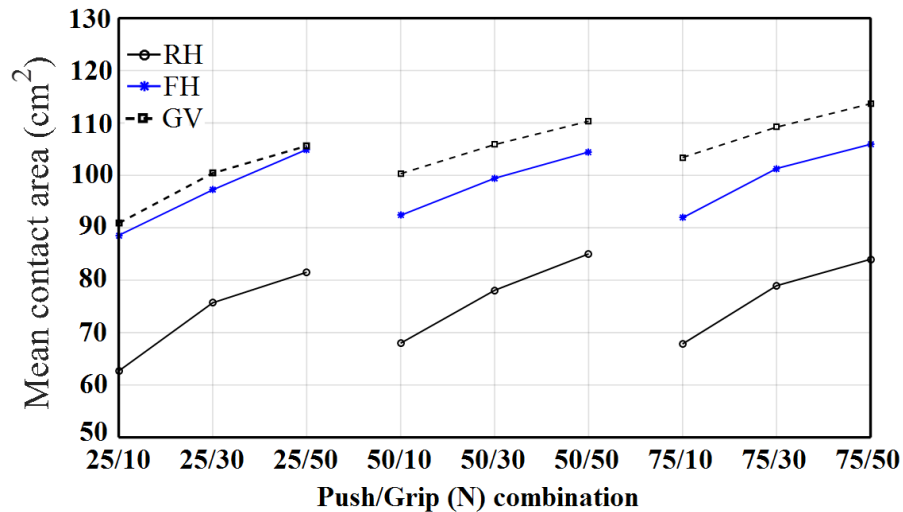

Figure 3. 8: Comparisons of mean contact area attained for the rigid (RH), viscoelastic (FH) and gloved (GV) hand-handle interface conditions as a function of hand push and grip forces combinations.

3.4.3 Contact force developed by the gloved hand

The contact force acquired for the gloved hand grasping the handle revealed intra-subject variations in the 2.6 to 8.7% range, which is comparable with those observed for the RH and FH conditions. The measurements with the gloved hand, however, revealed considerably high inter-subject variations (7.9 to 17.4%) compared to the other conditions. This is likely caused by variation in the contact between the hand sensor and the glove across the subjects. The coefficients of grip and push forces derived from multiple linear regression equation are presented in the Table 3.3. The coefficients of correlation ranged from 0.83 to 0.96 for the five participants. The mean values of α_g

(3.31) and α_p (1.52) are higher than those obtained with the RH condition of comparable handle diameter (50 mm). The identified coefficients, however, are closer to those obtained for the FH condition. This is likely due to the fact that the GV and FH conditions employed identical viscoelastic material. The grip and push force coefficients identified for the five participants, however, showed considerably higher variations compared to the RH condition. The CoVs of α_g and α_p were about 10.9% and 12.5%, respectively, which are higher than those obtained for the FH condition.

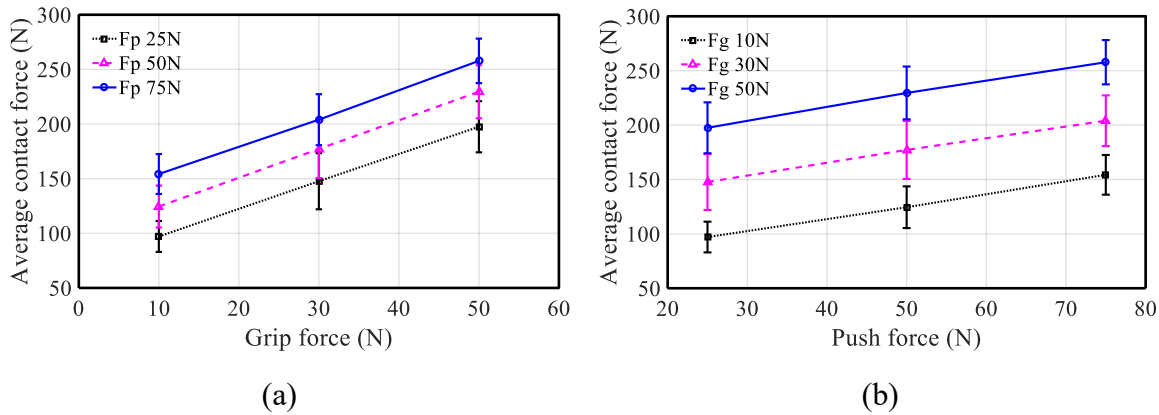

Figure 3. 9: Variations in the mean contact force measured at the glove-hand interface (GV) with: (a) hand grip force; and (b) hand push force.

There are significant differences in the hand force coefficients (α_g and α_p) between the RH and GV conditions, although coefficient values are comparable for the FH and GV conditions. The grip coefficient α_g is about 37.9% higher for the GV condition compared to the RH condition. The push force coefficient α_p is also increased by 34.5%, from 1.13 for the RH condition to 1.52 for the GV condition. However, the grip and push forces coefficients for the GV condition increased by 8.2% and 8.6%, respectively, only, when compared with the FH condition. The results further suggest that grasping the handle with the AV glove requires higher contact force to achieve a target grip and push forces, when compared to the rigid handle. The use of AV gloves would thus involve relatively higher grip strength demand from the operator compared to the bare hand considering identical hand grip and push forces. The effective contact area of the gloved hand is also considerably higher compared to the RH condition but only slightly higher when compared to the FH condition, as shown in Figure 3.9. The difference in the mean contact area is notably higher for higher push forces (50 and 75 N).

The correlation of the contact force with the coupling force, defined as the sum of the applied grip and push forces [127], is also illustrated in Figure 3.10 for the three interface conditions and nine hand force combinations considered. The results show a linear dependence of contact force on the coupling force, irrespective of the handle interface conditions. The results suggest that the viscoelastic interface due to AV material or AV glove leads to higher contact force compared to the RH condition for the entire range of coupling force considered. This is also evident from grip and push coefficients presented in Table 3.3.

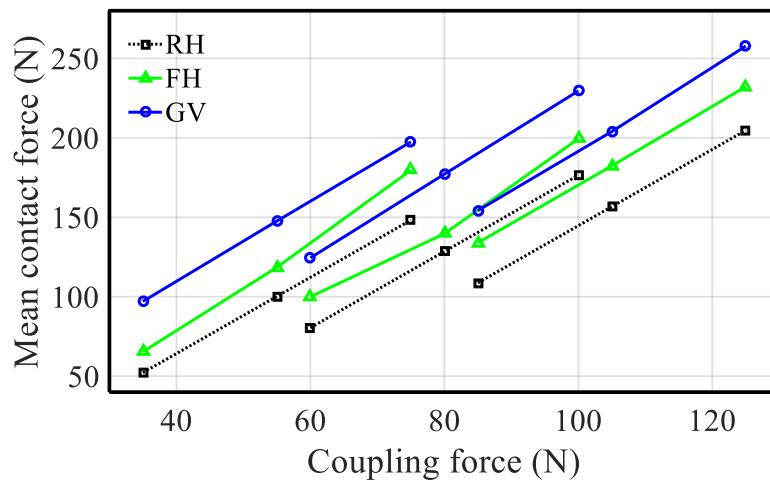

Figure 3. 10: Variations in the contact force with the coupling force obtained for rigid (RH) and viscoelastic contact conditions (FH, GV)

3.5 Conclusions

The thin and flexible resistive hand sensor showed good linearity and repeatability for measurement of the contact force with relatively small hysteresis and drift. The relationship between the contact force developed by the bare hand grasping a rigid handle with applied hand grip and push forces revealed very good agreements with those reported in the published studies. The proposed sensor design was thus considered for feasible for measurements of the hand contact force developed at the curved tool handle surface. The contact force developed by the bare hand grasping a tool handle enveloped by a viscoelastic vibration absorbing material or the hand grasping a rigid handle via an anti-vibration glove also revealed similar linear dependence on both the grip and push forces. The results showed contact force to be a linear combination of grip and push forces, where the influence of grip force is nearly three times larger than the influence of push force regardless of hand-handle conditions. The grip and push force coefficients for the handle covered by viscoelastic material, however, were about 27.5% and 24% higher when compared to the rigid handle condition

considering the same handle size. The contact force developed at the interface of the anti-vibration glove and the hand was also considerably higher compared to the bare hand grasping the handle but only slightly higher compared to the handle with an elastic material. The viscoelastic interface attributed to handle covering or the glove contributed to the higher hand-handle contact area and mean contact pressure, which contributed to the higher contact force. Working with anti-vibration gloves or tool handles with viscoelastic coverings would thus impose considerably greater grip strength demand on the operators in order to achieve target hand grip and push forces, when compared to the bare hand grasping a rigid handle with the same grip and push forces.

CHAPTER 4: DISTRIBUTED VIBRATION ISOLATION AND MANUAL DEXTERITY OF ANTI-VIBRATION GLOVES: IS THERE A CORRELATION?

4.1 Introduction

Anti-vibration gloves have evolved to help reduce the vibration transmitted to the hands of the power tool operators. However, wearing these gloves adversely affects operators' grip strength and manual dexterity [2, 3]. Designs of AV gloves with adequate dexterity and vibration attenuation are thus vital for promoting their usage. A study on the effect of design factors on both the measures together with the correlation between the vibration reduction and manual dexterity performances of AV gloves may provide the essential guidance for the AV gloves designs.

Although the vibration isolation performance of AV gloves has been extensively studied, their manual dexterity has been attempted only in this dissertation research [2]. A few studies reporting dexterity performance of protective gloves have shown that the manual dexterity decreases with increase in the glove thickness at the fingers [14]. AV gloves with relatively thick isolation materials, on the other hand, are believed to reduce the vibration transmission to the palm [8]. Moreover, manual dexterity performance of a glove is strongly influenced by many other design factors such as fitting and bulkiness [2, 14]. The vibration isolation effectiveness of an AV glove is generally assessed in terms of the w_h -weighted palm vibration transmissibility, the ratio of the vibration measured at the glove-palm interface to the handle vibration, as described in ISO 10819 [11]. The standard also defines the screening criterion for classification of a glove as an AV glove. A glove is considered as an AV glove if the w_h -weighted palm vibration transmissibility of the glove in M- and H-frequency ranges are no more than 0.9 and 0.6, respectively. This criterion, however, considers the vibration transmission to the palm alone. Moreover, the w_h frequency weighting implies relatively higher importance of low-frequency vibration than the intermediate and high-frequency vibration for predicting vibration-induced adverse health effects [11]. It generally overestimates the AV gloves effectiveness in limiting the fingers vibration in the H-frequency range [3, 155-157].

Dong et al. [39] reported that the w_h -weighting may be acceptable for approximately assessing the vibration perception or discomfort of the hand-arm system in certain ranges of vibration magnitude and frequency, it is not suitable for assessing finger vibration exposure. Alternate weightings have been proposed on the basis of epidemiological findings [158] or hand-arm biodynamic or power absorption responses [13, 38, 159] to quantify the risks of developing

symptoms of VWF from the hands' exposure to vibration. Among these, w_p -weighting is considered more suited to quantify the risk of developing symptoms of vibration white finger from exposure to the HTV [41]. It is also used in this study to evaluate the hand-transmitted vibration at the fingers.

Apart from the vibration reduction performance of AV gloves presented in chapter 1, a few recent studies have investigated the effects of AV material properties on the vibration transmissibility, namely, the material thickness and stiffness. Xu et al. [74] employed a rat-tail model to study impact vibration isolation effectiveness of the AV glove materials. The measurements of transmitted vibration distribution along the tail via a scanning laser vibrometer revealed considerable reduction in the peak acceleration by the AV materials. The strips of material from a gel-filled glove particularly showed notable vibration attenuation. Rezali and Griffin [7] measured the dynamic stiffness of foam and gel materials used in AV gloves and the vibration transmitted to the palm and the fingers through the materials. The study concluded that the AV materials effectively attenuate vibration transmitted to the palm but amplify fingers vibration response. The effect of a foam material thickness on the palm and fingers vibration responses were investigated through measurements of palm and index finger vibration together with the apparent mass [8]. Increasing the material thickness resulted in lower dynamic stiffness and reduced vibration at the palm but increased vibration at the finger in the 20 to 350 Hz frequency range. Reducing the dynamic stiffness of glove material may increase or decrease the transmission of vibration, depending on the material, the frequency of vibration and the location of measurement (palm or finger). It is further shown that the dynamic stiffness of the material and thereby its vibration isolation is affected by the hand force imparted on the material and the hand-material contact area [9, 160].

Increasing the material thickness, however, may adversely affect the manual dexterity performance of the glove. Only limited efforts, however, are evident in the dexterity performance of AV gloves [2]. Design of AV gloves with enhanced vibration isolation with acceptable dexterity performance would help promote their usage in the workplace. This study is aimed at integrated performance assessments of AV gloves involving the manual dexterity and vibration transmission to the palm and fingers of the hand. The correlations between the transmitted vibration and the dexterity performances are explored together with the roles of selected design factors in order to seek design guidance for AV gloves. This study is aimed at evaluating the integrated performance of AV gloves involving the manual dexterity and vibration transmission to the palm and fingers of

the hand. The correlations between the transmitted vibration and the dexterity performances are explored together with the roles of selected design factors in order to seek design guidance for AV gloves. Design of AV gloves with enhanced vibration isolation with acceptable dexterity performance would help promote their usage in the workplace.

The study involved measurements of vibration responses and dexterity scores of 10 different gloves with 15 healthy male subjects. The ASTM and Minnesota test methods were used to determine dexterity scores of the gloves (Chapter 2). The vibration response at the palm of the gloved hand measured in accordance with the method defined in ISO 10819 [11], and vibration responses of the gloved index and middle fingers were measured via finger adapters comprising miniature three-axis accelerometers. The palm and fingers' vibration transmission performance of gloves were evaluated using w_h - and w_p - frequency weightings, respectively. Static and dynamic stiffness and equivalent damping due to the glove materials were further characterized under harmonic loading at selected frequencies. The significant influences of different glove type and frequency range as well as their interaction on the w_h - and w_p -weighted palm and fingers' vibration transmissibility were determined using two-factor multivariate analysis of variance (Appendix C). The correlations of the palm and fingers vibration transmissibility, and the manual dexterity with the static and dynamic material properties and the glove thickness were investigated using Pearson's correlation coefficient (Appendix A). The results are used to proposed guidance for the design of AV gloves to achieve good vibration isolation while preserving good finger dexterity.

4.2 Design of experiments

4.2.1 Subjects and gloves

Fifteen healthy male subjects participated in both the experiments with hand sizes ranging from 8 to 10 in accordance with EN 420 standard [121]. The subjects' hand length and circumference ranged from 185 to 207 mm (mean = 192.4 mm; standard deviation = 5.8 mm) and 186 to 220 mm (mean = 206.1 mm; standard deviation = 9.6 mm), respectively. Each participant consented to the experimental protocol, which had been approved by the Human Research Ethics committee of Concordia University. The selected gloves included: five gloves with gel materials, denoted as *gell*,..., *gel5*; two gloves with air pockets material, denoted as *air1* and *air2*; one hybrid glove with air pocket material in palm region and gel in the fingers regions, denoted as *hybrid*; a *rubber* glove, denoted as *rubber*; and a fabric glove, denoted as *fabric*. The overall undeformed thickness of each glove was also measured in the index finger and palm regions (Table 4.1) in order to explore the

correlation between the glove thickness with the manual dexterity and the vibration transmissibility. The manual dexterity scores of these gloves (Table 4.1) were obtained with the ASTM and Minnesota tests, as presented in the chapter 2. The characteristics of the materials used in the selected gloves have been reported in [2].

Table 4. 1: Undeformed thickness and dexterity scores of the gloves measured using ASTM and Minnesota test methods

Glove type		<i>gel1</i>	<i>gel2</i>	<i>gel3</i>	<i>gel4</i>	<i>gel5</i>	<i>air1</i>	<i>air2</i>	<i>rubber</i>	<i>hybrid</i>	<i>fabric</i>
Mean Dexterity score	ASTM	1.51	1.26	1.43	1.31	1.40	1.73	1.30	1.14	1.31	1.20
	Minnesota	1.54	1.35	1.36	1.28	1.63	1.70	1.35	1.32	1.40	1.16
Undeformed thickness (mm)	Palm	4.4	6.8	8.2	4.3	8.0	7.2	6.7	1.5	8.1	1.1
	Fingers	4.4	6.6	8.2	4.1	8.0	7.2	6.7	1.5	5.7	1.2

4.2.2 Measurements of vibration isolation performance of AV gloves

The experimental setup for characterizing the vibration transmission effectiveness of AV gloves is shown in Figure 4.1(a), which has been described in many reported studies [4, 5, 11]. The setup involves a single axis electrodynamic exciter oriented to generate vibration along the forearm direction (z_h -axis) using a 40 mm diameter and 140 mm long instrumented split-handle. The handle integrated two single-axis force sensors and a three-axial accelerometer for measurements of the grip force and handle acceleration, respectively. Two additional force sensors were installed between the handle and handle support for measurement of the push force. The measured hand push and grip forces were displayed on a computer screen to facilitate the control of forces by the subject, as described in earlier studies [3]. Handle vibration spectrum, defined in ISO 10819 [11], was synthesized and controlled via a vibration controller.

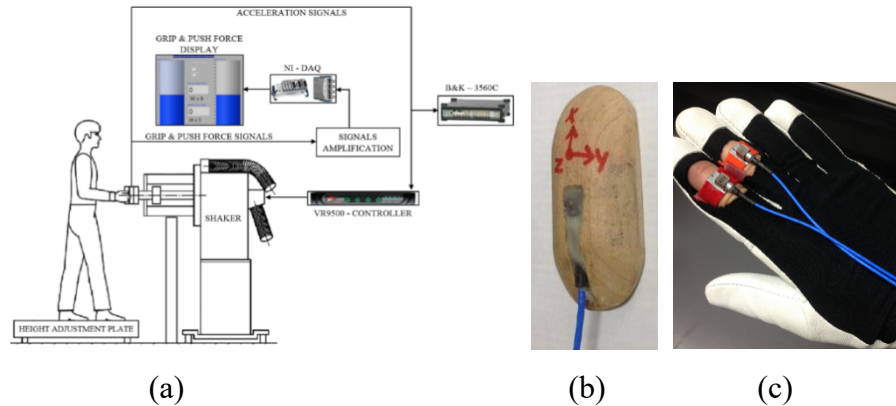

Figure 4. 1: (a) Experimental setup; (b) Palm adapter; and (c) Velcro finger adapters [5]

The palm vibration transmissibility characteristics of each glove were measured using the standardized palm adapter with a three-axis accelerometer, shown in Fig. 4.1(b). It has been reported that the vibration responses at the mid-phalanges of the fingers are relatively higher than those at the distal and proximal phalanges [6]. The vibration transmitted to the mid phalanges of the index and middle fingers were thus measured using the Velcro finger adapters (Figure 4.1(c)), described in [3]. Each finger adapter comprised a light weight three-axis accelerometer (1 gram), which could be conveniently attached to the fingers with desired tightness to ensure minimal relative motion between the adapter and the finger.

The vibration responses at the fingers and palm were measured with and without the glove. A total of 11 hand conditions were considered, which included bare hand and 10 gloves. The top coverings of these gloves were cut around the mid-phalanges of the index and middle fingers in order to install the finger adapters on the respective fingers (Fig. 4.1(c)). The cut is unlikely to have a substantial effect on the fingers' transmissibility of the glove since the vibration isolation material between the fingers and the vibrating surface is retained [161]. The experimenter installed the Velcro adapters at both the fingers and ensured the correct location and tightness of the adapters with and without wearing a glove. The subject was also asked to place the palm adapter inside the glove and align it along the axis of the vibration exciter to his best ability and perception. The instrumented handle was excited using the broad-band random vibration spectrum in the 25-1600 Hz frequency range, as defined in [11]. The subjects grasped the handle with 30 ± 5 N grip and 50 ± 8 N push force with the bare hand or wearing an AV glove, while maintaining the posture in accordance with ISO 10819 [11]. When the grip and push force on the handle was stabilized, the signals from the handle, palm and fingers' accelerometers were acquired in a multi-channel data

acquisition and analysis system for a duration of 30 s. Each subject performed three trials for each hand condition, while ensuring a 2 minutes break between the consecutive trials. Posture and hand force combination (push and grip) were kept the same in all the trials. The sequence of measurements was randomized among the subjects and the 11 hand conditions.

4.2.3 Characterizations of glove materials' properties

The stiffness and damping properties of the materials used in the selected gloves were estimated to study the correlations of the vibration transmissibility and manual dexterity with the material properties. For this purpose, a simple experiment was designed to measure force-deflection and force-velocity characteristics of each material in the laboratory. The top covering of each glove was removed so as to apply load to the vibration isolation material of the glove. Each glove material was placed on the platform of an electro-hydraulic vibration exciter (MTS). A rigid 1 cm thick load indenter (6.6x2.8 cm), fixed to adjustable inertial support via a force transducer, was positioned on the glove material, as shown schematically in Figure 4.2. In order to simulate the contact force at the hand-handle interface when applied the 30 N grip and 50 N force, each material was preloaded to 140 N by displacing the hydraulic actuator statically. The quasi-static stiffness of each material was measured by applying 0.75 mm amplitude harmonic displacement at 0.1 Hz. The displacement and velocity of the actuator measured via the linear variable differential transformer and the linear velocity transducer, respectively, were acquired together with the signal from the force sensor in a data acquisition system. The dynamic properties of each material were subsequently measured by applying 0.75 mm amplitude displacement at 20 Hz and 30 Hz. These frequencies were selected since the vibration transmissibility of AV gloves measured at the palm generally exhibit fundamental peaks in the 20 to 30 Hz frequency range [3, 6].

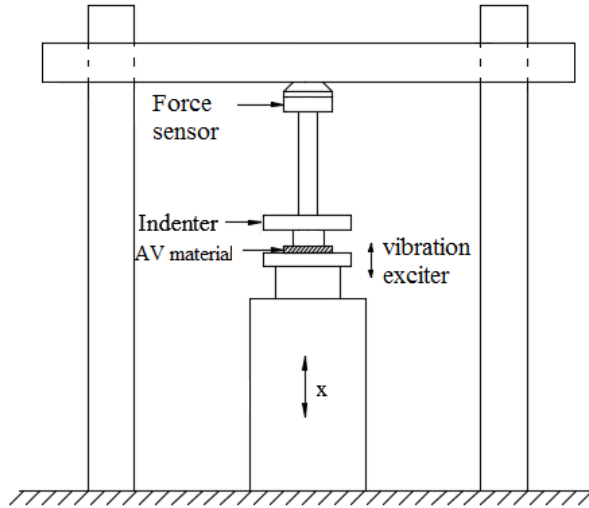

Figure 4. 2: Schematic diagram of the laboratory setup for characterizing glove material properties

Owing to the comparable thickness of materials in the palm and fingers regions of the gloves (Table 4.1), the loading was limited to the material in the palm region. The *hybrid* glove with different anti-vibration materials in the palm (air-bladder) and the fingers (gel) regions, however, formed an exception. In this case, the force-deflection and force-velocity characteristics were acquired for the materials in the palm and the fingers regions, denoted as *hybrid_{palm}* and *hybrid_{finger}*. The measurements were thus performed on 11 different materials including the conventional fabric glove material. The force-deflection and force-velocity data acquired for each material were analyzed to estimate static and dynamic stiffness and equivalent viscous damping of each material.

4.2.4 Data analysis

The manual dexterity score was calculated used the equation 2.1, and the detailed data analysis methods were described in the chapter 2. The vibration signals acquired from the three-axis handle, and palm and fingers adapter accelerometers were analyzed to obtain root mean square acceleration values in the one-third octave frequency bands in the 25 to 1250 Hz frequency range. Unlike the normal vibration analysis method which using a ratio of two complex numbers, vector sums of measured accelerations were subsequently obtained, as:

$$A(f_i) = \sqrt{[A_x(f_i)]^2 + [A_y(f_i)]^2 + [A_z(f_i)]^2} \quad (4.1)$$

$$H(f_i) = \sqrt{[H_x(f_i)]^2 + [H_y(f_i)]^2 + [H_z(f_i)]^2} \quad (4.2)$$

where $A(f_i)$ is the resultant acceleration measured at the palm or the finger at center frequency f_i of the i^{th} frequency band, and $H(f_i)$ represents the vibration of the handle. The palm and fingers vibration transmissibility characteristics of each glove were also obtained in the entire frequency range, as $TR(f_i) = \overline{A(f_i)} / \overline{H(f_i)}$, where $\overline{A(f_i)}$ and $\overline{H(f_i)}$ are the mean values of total acceleration values of palm/fingers and handle vibration, respectively, obtained for the three trials corresponding to center frequency f_i .

The unweighted and frequency-weighted palm and fingers' vibration transmissibility were subsequently evaluated from the data acquired for the bare and the gloved hands considering the ratio of the total transmitted vibration to the handle vibration in the M (25-200 Hz) and H (200-1250 Hz) frequency ranges, as recommended in ISO 10819 [11]; such that:

$$TR_{W(glove)} = \frac{\sqrt{\sum_{i=L}^U [A(f_i).w_i]^2}}{\sqrt{\sum_{i=L}^U [H(f_i).w_i]^2}} \quad (4.3)$$

The upper and lower limits of the frequency bands in the M- and H- frequency ranges are denoted by U and L , respectively. It should be noted that the upper of the H- frequency range in this study was limited to 1000 Hz. w_i in the above equation represents the magnitude of the frequency weighting corresponding to center frequency f_i . The palm vibration transmissibility of the glove is assessed by letting $w_i = w_{hi}$, (w_h weighting) as recommended in ISO 10819 [11]. Owing to considerably higher frequencies of dominant vibration transmitted to the fingers (resonance frequencies), as reported in [3, 6], the fingers vibration performance of the gloves is evaluated considering the w_p -weighting ($w_i = w_{pi}$) defined in ISO 18570 [11]. The w_h -weighted palm vibration transmissibility of each glove was normalized with respect to that obtained for the bare hand, as recommended in ISO 10819 [11]. The unweighted and w_p -weighted fingers vibration transmissibility values for each glove were also normalized with respect to those obtained for the bare hand in order to assess attenuation or amplification of vibration by the glove relative to the bare hand.

$$\text{Corrected_TR}_{(glove, Normalized)} = \frac{TR_{(glove)}}{TR_{(bare hand)}} \quad (4.4)$$

The data were also analyzed to identify peak magnitudes and the corresponding frequencies (dominant frequencies) of the normalized vibration transmissibility of the palm and the fingers for each subject-glove combination. The mean values of the peak magnitudes and the corresponding frequencies were obtained for the 15 subjects for each glove together with the coefficient of

variations (CoV) of the means in order to build an understanding of vibration isolation performance of different gloves, and to examine the inter-subject variabilities. Two-factor multivariate analysis of variance (MANOVA) was performed to determine the significant influences of different glove type and frequency range (M-/H-) as well as their interaction on the w_h - and w_p -weighted palm and fingers' vibration transmissibility. The significant difference among the data was considered, when $p < 0.05$. Moreover, the statistical correlations of the frequency-weighted palm and fingers vibration transmissibility with the glove thickness, and static and dynamic properties of the materials were evaluated.

4.3 Results

The coefficient of determination (R^2) among the glove thickness, stiffness/damping properties of the materials, and the manual dexterity score and normalized frequency-weighted palm and fingers vibration transmissibility ratios (TR) in the M- and H- frequency ranges were explored via linear regression analyses. The results were further verified using Pearson's correlation.

4.3.1 Manual dexterity scores of AV gloves

The detailed results of manual dexterity score are presented in the chapter 2. The results show mean manual dexterity score of all the gloves in excess of unity value, irrespective of the test method, which suggests that all the tested gloves reduce manual dexterity [2]. The extent to which gloves impaired the dexterity, however, differed with the glove type. Briefly, the *fabric* and *rubber* gloves showed the best dexterity (lowest score), while the *air1* showed the worst dexterity score, followed by the scores for the *gel1* and *gel5* gloves (Table 4.1). This was consistently observed for both the test methods. Greatest variability in manual dexterity was observed for the *air1* glove in both the test methods, followed by the *gel3* and *gel1* gloves. The results showed a good correlation between the manual dexterity scores obtained from the ASTM and Minnesota test methods ($R^2=0.68$). Moreover, the main effect of glove type revealed a statistically significant difference on manual dexterity ($p < 0.001$), while the test method had no significant effect on the manual dexterity ($p=0.112$). The dexterity scores obtained from the ASTM test method alone were thus considered for the subsequent analyses of correlations. The results also showed a significant interaction effect between the glove type and the test method on manual dexterity ($p < 0.01$). The results showed a good degree of correlations between glove thickness and manual dexterity score in both the test methods, which were statistically significant ($p < 0.05$).

4.3.2 Vibration transmissibility at the palm

The intra-subject variability of the unweighted palm vibration transmissibility magnitudes of 10 gloves and bare hand condition were computed for each subject. The coefficient of variation, the ratio of the mean of three trials to the associated standard deviation, was less than 4% in the entire frequency range, irrespective of the hand condition. The mean palm vibration transmissibility of 15 subjects with bare hand condition was in the vicinity of 1 in the 25 to 1250 Hz frequency range, which ensured the validity of the measurements, as stated in ISO 10819 [11]. Relatively higher inter-subject variability of the unweighted palm vibration transmissibility, however, was observed for most of the gloves, especially in the H-frequency range (Table 4.2), which ranged from 4% to 13% and 8%-20% in the M- and H-frequency ranges, respectively. Relatively low inter-subject variations were obtained for the *rubber*, *fabric*, *gel3*, *gel4* and *gel5* gloves with CoV ranging from 1% to 6% and 8%-14% in the M- and H- frequency, respectively. Relatively higher variability was evident for *gel1*, *gel2*, *air*, and *hybrid* gloves with the CoV ranging from 7% to 13% and 13% to 20% in the M- and H- frequency (Table 4.2).

Table 4. 2: Mean normalized unweighted and frequency-weighted palm and fingers vibration transmissibility of the test gloves in the M-and H-frequency ranges.

Frequency range	Glove type	Unweighted			Frequency-weighted		
		Palm	Index finger	Middle finger	Palm (w_h)	Index finger (w_p)	Middle finger (w_p)
		Mean (%CoV)	Mean (%CoV)	Mean (%CoV)	Mean (%CoV)	Mean (%CoV)	Mean (%CoV)
M-	<i>gel1</i>	0.93 (7)	0.96 (10)	0.77 (14)	0.93 (6)	0.93 (13)	0.76 (13)
	<i>gel2</i>	0.78 (7)	1.05 (15)	0.98 (13)	0.82 (4)	1.01 (19)	0.94 (16)
	<i>gel3</i>	0.93 (4)	1.03 (12)	0.83 (12)	0.90 (3)	1.01 (13)	0.85 (13)
	<i>gel4</i>	0.95 (4)	0.97 (12)	0.93 (12)	0.95 (2)	0.95 (14)	0.91 (12)
	<i>gel5</i>	0.85 (6)	1.00 (13)	0.87 (12)	0.87 (3)	0.98 (13)	0.88 (12)
	<i>air1</i>	0.75 (13)	0.91 (13)	0.85 (12)	0.81 (7)	0.91 (13)	0.87 (18)
	<i>air2</i>	0.74 (10)	0.92 (12)	0.80 (13)	0.79 (7)	0.97 (26)	0.81 (14)
	<i>rubber</i>	0.94 (4)	1.10 (10)	0.97 (12)	0.94 (2)	1.09 (10)	0.96 (13)
	<i>hybrid</i>	0.74 (11)	0.90 (13)	0.79 (14)	0.79 (6)	0.91 (13)	0.78 (14)
	<i>fabric</i>	0.99 (1)	1.06 (11)	0.91 (13)	0.98 (2)	1.03 (14)	0.92 (14)
H-	<i>gel1</i>	0.95 (15)	0.94 (22)	0.95 (17)	1.07 (12)	0.92 (23)	0.84 (29)
	<i>gel2</i>	0.34 (13)	0.50 (21)	0.49 (20)	0.41 (10)	0.55 (26)	0.50 (25)
	<i>gel3</i>	0.75 (12)	0.77 (19)	0.74 (16)	0.74 (13)	0.79 (16)	0.71 (17)
	<i>gel4</i>	1.00 (14)	0.96 (19)	0.93 (27)	1.01 (20)	0.92 (21)	0.77 (28)
	<i>gel5</i>	0.54 (9)	0.72 (21)	0.70 (24)	0.57 (12)	0.79 (19)	0.76 (25)
	<i>air1</i>	0.35 (20)	0.72 (24)	0.70 (25)	0.51 (21)	0.75 (25)	0.69 (30)
	<i>air2</i>	0.37 (13)	0.68 (24)	0.74 (20)	0.43 (16)	0.72 (21)	0.80 (28)
	<i>rubber</i>	1.01 (8)	0.98 (20)	0.89 (18)	1.03 (19)	1.07 (19)	0.86 (23)
	<i>hybrid</i>	0.33 (20)	0.86 (25)	0.84 (26)	0.39 (16)	0.88 (18)	0.78 (27)
	<i>fabric</i>	1.02 (12)	1.03 (18)	1.05 (19)	1.07 (16)	1.03 (21)	1.02 (28)

As an example, Figure 4.3 compares the mean palm TR obtained for 15 subjects and 6 different AV gloves. These include one from each class of gloves (*air*, *hybrid*, *rubber* and *fabric*) and two gel gloves, namely, *gel1* and *gel2*. The *air* and *hybrid* as well as *gel2* and *gel5* gloves generally showed notable attenuation of palm vibration compared to the other gloves, which showed 13%-21% and 43%-61% attenuation of handle vibration to the palm in the M- and H-frequency ranges, respectively (Table 4.2), with only slight amplification in the vicinity of the fundamental resonance frequencies occurring below 30 Hz for all the gloves. A similar trend was also evident for *gel3* and *rubber* gloves, but with relatively less vibration attenuation at frequencies above 30 Hz. The palm vibration transmissibility of *gel1* and *fabric* gloves were near unity for the majority of the subjects in most of the frequency range, suggesting minimal or no vibration attenuation. However, *gel1* glove exhibited a slight reduction (7%) in vibration in the M- frequency range (Table 4.2).

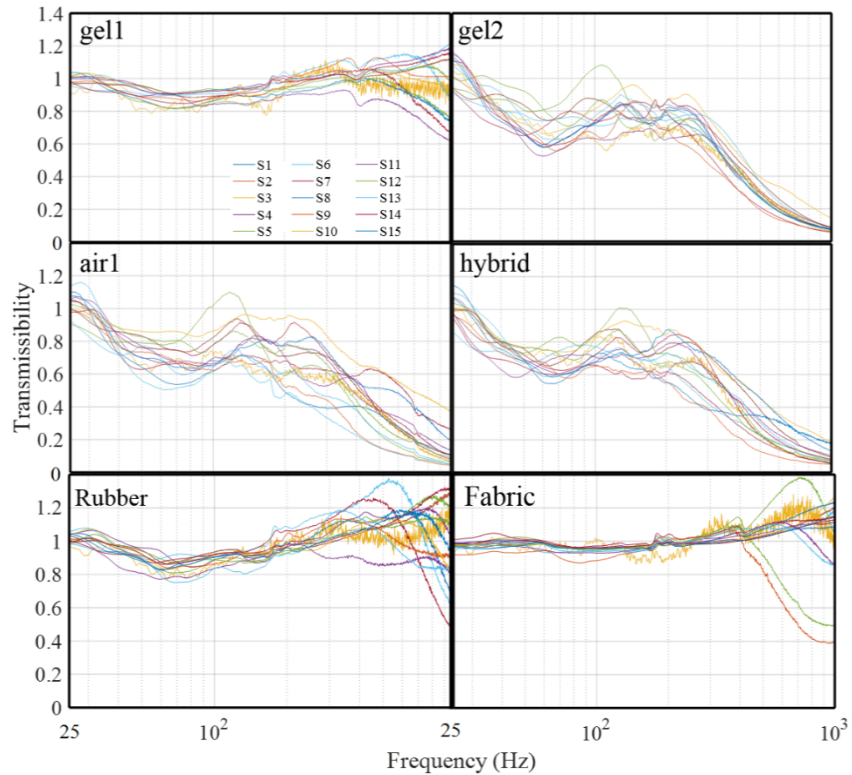

Figure 4. 3: Comparisons of mean palm vibration transmissibility of subjects with different gloves.

The mean and CoV values of the peak transmissibility at the palm and the corresponding frequencies (denoted as dominant frequency) of each glove and bare hand are summarized in Table 4.3. Relatively higher peak palm vibration magnitudes were generally evident for *gel2* and *gel5*, *air1*, *air2* and *hybrid* gloves, while *fabric* glove revealed the smallest peak transmissibility. The peak transmissibility of all the gloves occurred within a narrow frequency range (25.0-28.3 Hz), while the dominant frequency of bare hand occurred at 47.5 Hz. Relatively higher inter-subject variability in peak transmissibility ($\leq 8\%$) was shown for *gel2*, *gel5*, *air1*, *air2* and *rubber* gloves, which was comparable with that in the dominant frequency ($\leq 9\%$).

Table 4. 3: Mean peak vibration transmissibility magnitudes and corresponding frequency obtained at the palm, and index and middle fingers for the bare hand and gloved hand.

Glove	Palm		Index finger		Middle finger	
	Peak magnitude	Dominant frequency (Hz)	Peak magnitude	Dominant frequency (Hz)	Peak magnitude	Dominant frequency (Hz)
	Mean (%CoV)	Mean (%CoV)	Mean (%CoV)	Mean (%CoV)	Mean (%CoV)	Mean (%CoV)
<i>BH</i>	1.01 (1)	47.50 (2)	1.86 (14)	118.25 (12)	1.86 (14)	211.44 (19)
<i>gel1</i>	1.01 (3)	27.25 (9)	1.89 (13)	122.39 (8)	1.39 (6)	187.81 (37)
<i>gel2</i>	1.07 (8)	25.00 (0)	2.38 (17)	109.58 (24)	2.03 (10)	125.87 (19)
<i>gel3</i>	1.04 (5)	26.75 (6)	2.05 (14)	137.14 (12)	1.62 (9)	125.00 (9)
<i>gel4</i>	1.00 (1)	25.42 (5)	1.84 (12)	154.69 (17)	1.69 (6)	165.58 (33)
<i>gel5</i>	1.09 (8)	26.92 (7)	1.79 (7)	127.41 (27)	1.65 (6)	138.02 (32)
<i>air1</i>	1.04 (6)	25.67 (6)	1.86 (11)	140.63 (9)	1.66 (8)	136.44 (10)
<i>air2</i>	1.05 (8)	25.75 (5)	1.93 (12)	131.73 (8)	1.52 (5)	160.57 (29)
<i>rubber</i>	1.02 (7)	25.08 (1)	2.08 (8)	141.36 (28)	1.86 (6)	146.25 (34)
<i>hybrid</i>	1.05 (3)	28.33 (9)	1.78 (12)	139.17 (18)	1.56 (7)	167.38 (33)
<i>fabric</i>	0.99 (2)	26.04 (6)	2.10 (7)	140.00 (21)	1.67 (8)	179.06 (33)

CoV: coefficient of variation; BH: bare hand.

The normalized overall unweighted and w_h -weighted palm vibration transmissibility magnitudes of the gloves in the M- and H- frequency ranges are also presented in Table 4.2 in terms of the mean and CoV of the mean. The results show comparably unweighted and w_h -weighted palm vibration isolation performance of gloves in the M-frequency range. The magnitudes were obtained upon normalization with respect to that of the bare hand, as recommended in ISO 10819 [11]. Relatively lower CoV values of the w_h -weighted palm vibration transmissibility were obtained in the M- frequency range (2%-7%) compared to those in the H-frequency range (10%-21%). *Air1* glove showed the highest CoV of w_h -weighted palm vibration transmissibility in both the frequency ranges, while the thin *rubber*, *fabric* and *gel4* gloves showed the lowest CoV in the M- frequency range. The *gel2* revealed the lowest CoV in the H- frequency range (10%). The *air1*, *air2*, *hybrid*, *gel2* and *gel5* gloves show superior vibration attenuation performance than the rest of the gloves in both the frequency ranges. These gloves are also shown in boldface font in Table 4.2. These gloves also satisfy the screening criteria for an AV glove defined in ISO 10819 [11], which requires that the mean normalized overall w_h -weighted transmissibility at the palm does not exceed 0.9 and 0.6 in M- and H- frequency ranges, respectively. Figure 4.4 presents the w_h -weighted palm vibration transmissibility of the gloves together with the screening criteria.

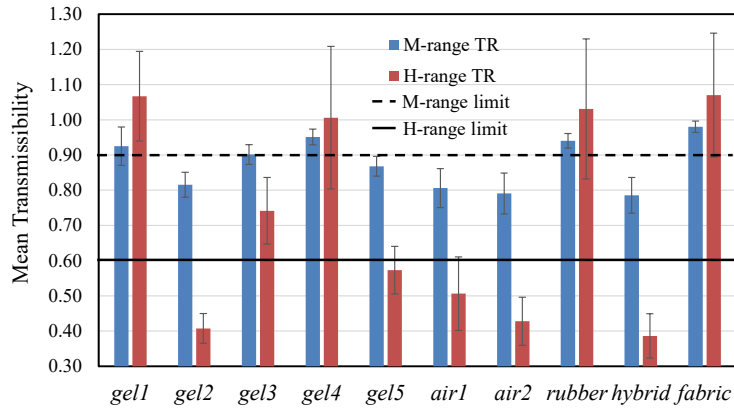

Figure 4. 4: Comparisons of overall w_h -weighted palm vibration transmissibility (TR) of different gloves in the M- and H-frequency ranges and the screening criteria defined in the ISO 10819 [11].

The results from MANOVA (Table 4.4) also showed that the glove type has a significant influence on the w_h -weighted vibration transmissibility ($p < 0.001$). Moreover, the mean overall normalized palm vibration transmissibility of *gel3* glove satisfies the glove screening criteria only in the M- frequency range, which cannot be considered as an AV glove. This suggested that the frequency range has a significant influence on the w_h -weighted vibration transmissibility, which is consistent with the MANOVA results ($p < 0.001$) in Table 4.4. Moreover, the MANOVA results also show the subject has no significant influence on the w_h -weighted vibration transmissibility at the palm ($p = 0.113$). Therefore, the acceptance or rejection of a glove on the basis of the screening criterion may not be affected by the inter-subject variability, although 15 subjects participated in this study rather than using only 5 subjects as required in the standardized method.

Table 4. 4: p -values obtained from two-way MANOVA for the effects of different factors on the w_h -weighted vibration transmissibility at the palm and fingers

p -values	w_h - weighted palm TR	w_p -weighted index finger TR	w_p -weighted middle finger TR
Subject	.113	.000	.000
Glove type	.000	.001	.000
Frequency range	.000	.047	.000
Glove type *Frequency range	.000	.074	.000

Glove thickness	.000	.106	.000
Material stiffness	.000	.075	.000
Material damping (20/30 Hz)	.000	.072/.075	.000

TR: Transmissibility.

4.3.3 Vibration transmissibility at the fingers

Figures 4.5 and 4.6 compare the index and middle fingers vibration transmissibility characteristics of selected gloves, respectively. The measured data obtained for 15 subjects showed relatively lower variability in M-frequency range than that in H- frequency range for both the fingers, irrespective of the glove type, as observed in the palm vibration transmissibility data. Both the unweighted index and middle fingers showed comparable inter-subject variability for all the gloves with CoV ranging from 10% to 15% and 12% to 14% in the M-frequency range, and from 18%-25% and 16%-27% in the H-frequency range. The data acquired for all the gloves showed relatively small inter-subject variability for the *rubber* and *fabric* gloves, with CoV in the orders of 10% and 18% in the M- and H- frequency ranges, respectively. Relatively higher variability was evident for the *gel2*, *air1*, *air2*, and *hybrid* gloves with the CoVs ranging from 12% to 15% and 21% to 25% in the M- and H- frequency ranges, respectively.

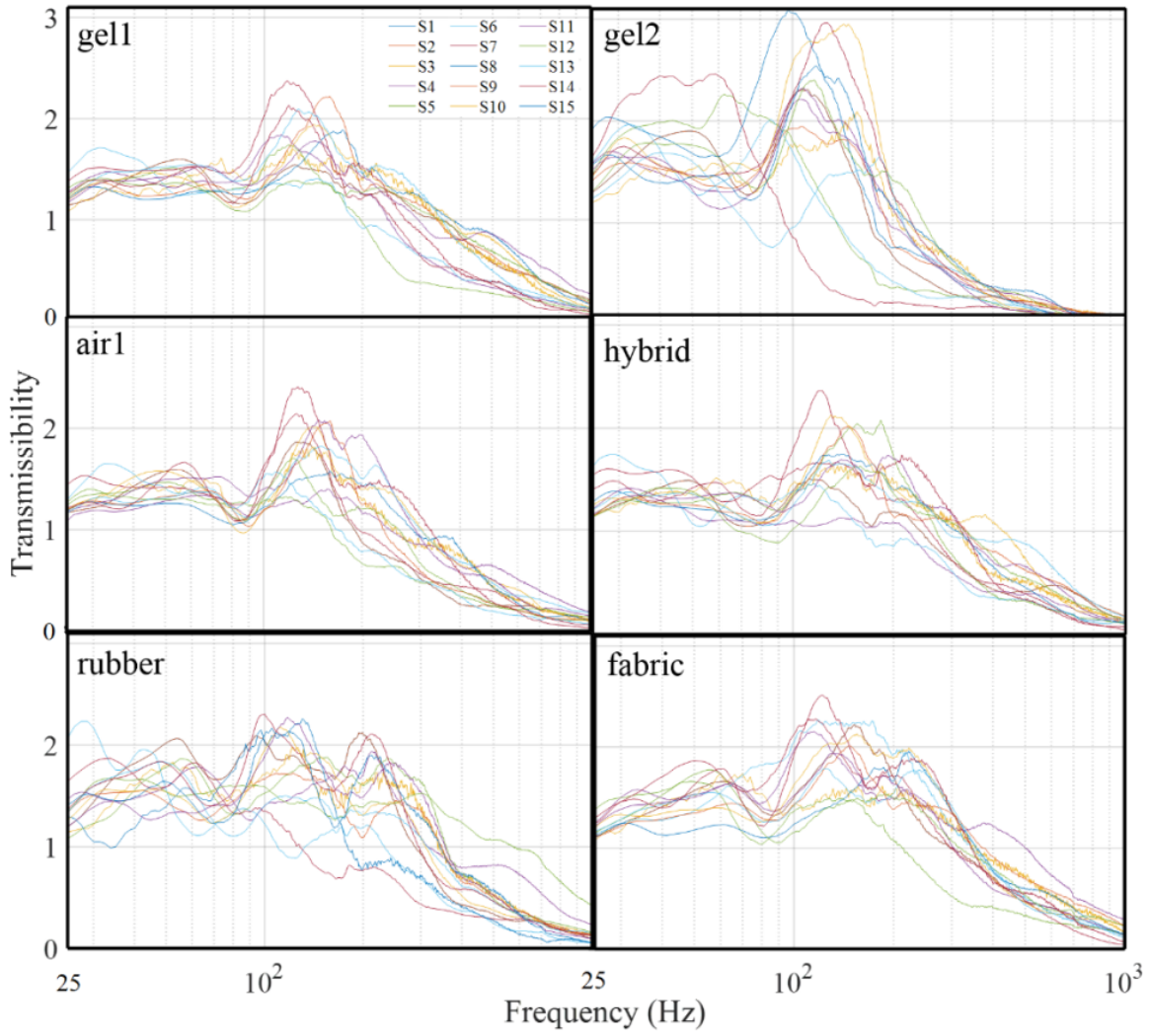

Figure 4. 5: Comparisons of mean index finger vibration transmissibility of different subjects with different AV gloves

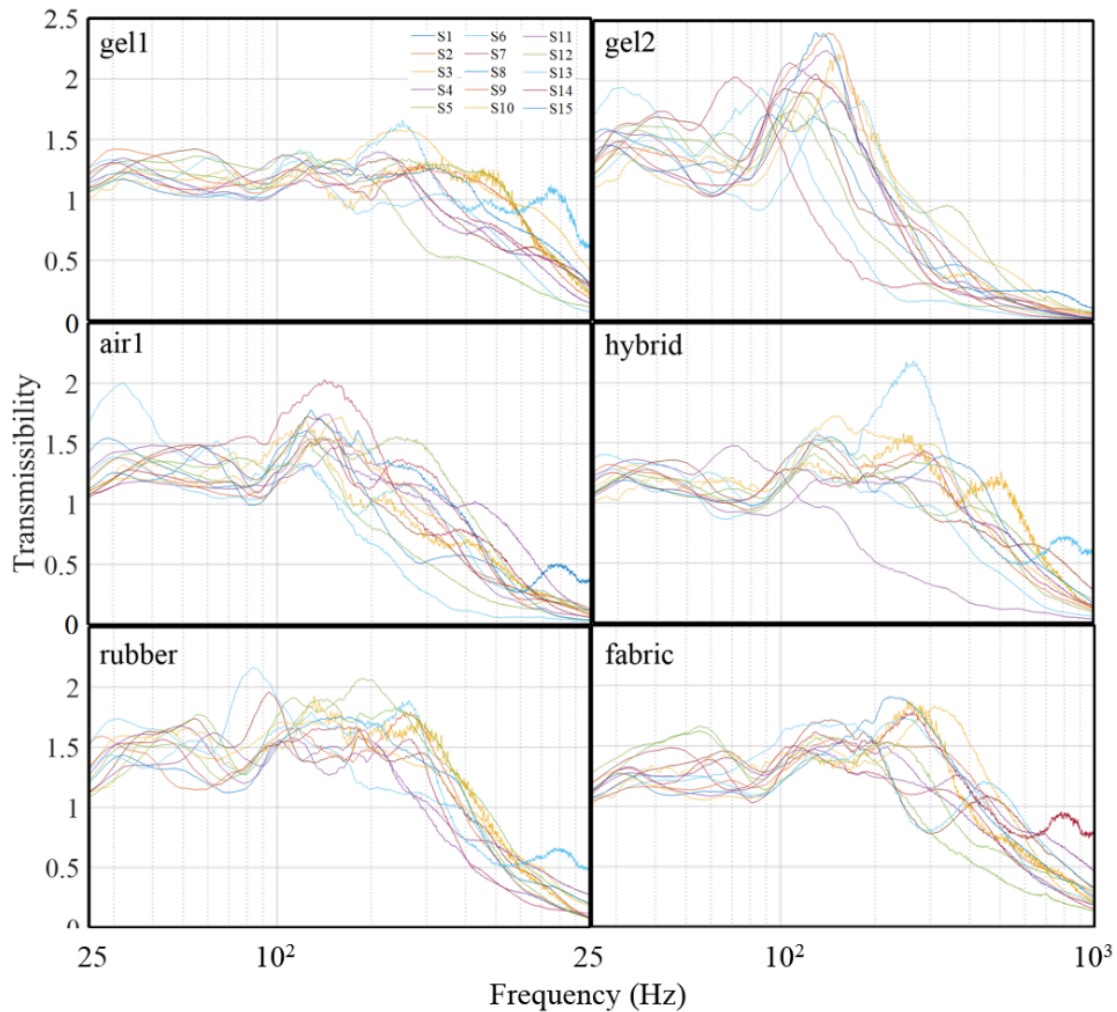

Figure 4. 6: Comparisons of mean middle finger vibration transmissibility of different subjects with different AV gloves

The handle vibration transmitted to the fingers of the bare hand was generally amplified in the 25-400 Hz frequency range by the gloves. The peak vibration transmissibility magnitudes at the index and middle fingers with the bare hand were about 1.86 with the CoV of 14%, while the corresponding dominant frequencies are 118.3 and 211.4 Hz, respectively. The transmissibility peaks of the index and middle fingers with the gloves occurred around 109.3-154.7 Hz and 125.0-187.8 Hz frequency ranges, respectively. The corresponding CoV of the dominant frequencies ranged from 8%-28% and 9%-37%, respectively, as shown in Table 4.3. Moreover, the subject, glove type and frequency range showed significant influence on w_p weighted fingers vibration transmissibility, as illustrated in Table 4.4.

Figure 4.7 compares the mean fingers' transmissibility magnitudes of the gloved hand of the subjects normalized with respect to those of the bare hand fingers, which represent the relative vibration attenuation performance of the gloves at the fingers. The gloves are classified into two groups based on the vibration isolation performance. Group A (left column) includes all the gloves which do not pass the screening criteria related to palm transmissibility, namely, *gel1*, *gel3*, *gel4*, *rubber* and *fabric*. Group B (right column) includes the rest of the AV gloves, namely, *air1*, *air2*, *gel2*, *gel5* and *hybrid*. The results generally show either small attenuation or amplification of the handle vibration transmitted to both the fingers by all the gloves in the M- frequency range, when compared to that of the bare hand. All the gloves in group B show comparable vibration transmission to the fingers in the entire frequency range, except for the *gel2* glove. The *gel2* glove shows greatest vibration attenuation to the fingers in the H- frequency range, with slight amplification in the M- frequency range. All the gloves in group A show lower vibration transmission to the middle finger than that to the index finger in the 25-400 Hz frequency range, while comparable vibration transmission is observed for gloves within group B for both the fingers.

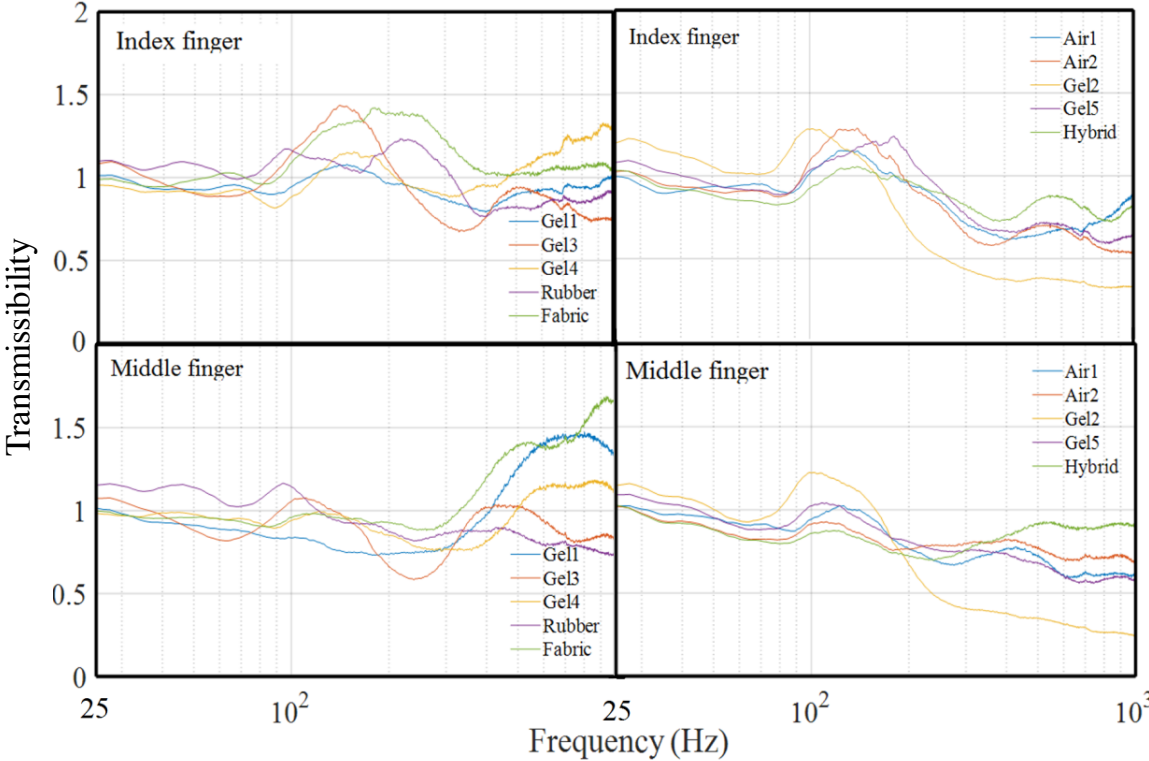

Figure 4. 7: Comparisons of mean vibration transmissibility characteristics of the gloved index and middle fingers normalized with respect to those of the bare hand.

The peak vibration transmissibility magnitudes and the corresponding frequencies of the index and middle fingers with each glove and bare hand conditions were obtained for each subject, in order to get the mean peak vibration of the index and middle fingers and the corresponding frequencies. These are summarized in Table 4.3, together with the CoVs of the mean vibration transmissibility. The results show all the gloves, with the exception of *gel2* and *rubber* gloves, help in reducing the peak vibration transmissibility to the middle finger, although the degree of the reduction is small. All the gloves, with the exception of the *hybrid* glove, on the other hand, yield higher peak vibration transmissibility of the index finger compared to the bare hand. Moreover, the peak magnitudes of the index finger are considerably greater than those of the middle finger, irrespective of the glove type. The mean dominant frequency of the index finger of the bare hand (118.3 Hz) is lower than those observed with the gloves (122.4-141.4 Hz), excluding the *gel2* glove, which shows a peak at 109.6 Hz. However, the mean dominant frequency of the middle finger of the bare hand (211.4 Hz) is higher than those observed with the gloves (152.0-187.8 Hz). The gloves thus generally tend to increase the index finger dominant frequency, while decreasing the middle finger dominant frequency. The CoV of the index finger dominant frequency were generally lower than those of the middle finger for both the bare and gloved hands, except for the *gel2* and *gel3* gloves.

Table 4.2 also presents the mean overall normalized unweighted and w_p -weighted fingers vibration transmissibility values for each glove in the M- and H- frequency ranges, together with the CoVs of the means. Relatively lower CoV of the unweighted vibration transmissibility for both the fingers were obtained in the M-frequency range when compared with those in the H- frequency range. With the exception of *gel2*, *gel3*, *gel5*, *rubber* and *fabric* gloves, the rest of gloves attenuate the index finger transmitted vibration in the M- frequency range, irrespective of the frequency-weighting used. However, all the gloves attenuate the vibration transmitted to the middle finger in the M-frequency range. All the gloves with the exception of the *rubber* and *fabric* gloves attenuate the w_p -weighted vibration transmitted to both fingers in the H-frequency range. The degree of attenuation of the finger vibration by the glove, however, is strongly dependent on the glove type. This was also evident from the results of MANOVA ($p \leq 0.001$) in Table 4.4. The results for the *fabric* glove consistently show amplification of vibration transmitted to both the fingers, irrespective of the frequency weighting used. The *air1* and *hybrid* gloves provided the best vibration attenuation to the index finger (TR=0.91) in the M- frequency range, while *gell* (TR=0.76) and

hybrid (TR=0.78) gloves provided relatively better vibration attenuation to the middle finger in the M- frequency range, although the *gel1* is not considered as an AV glove based on the palm vibration screening criteria. The *gel2* glove revealed the greatest vibration attenuation in the H-frequency range (TR_{index}: 0.55; TR_{middle}: 0.50).

4.3.4 Properties of the glove materials

The force-deflection and force-velocity data acquired for the glove materials were analyzed to identify their equivalent stiffness and viscous damping coefficient C_{eq} using the principle of energy similarity [162]:

$$C_{eq} = \frac{\Delta E}{\pi \omega X^2} \quad (4.5)$$

where ΔE is the energy dissipated by the material during one cycle of vibration, which is determined by the area founded by the force-displacement loop, ω is the excitation frequency and X is the displacement amplitude.

As an example, Figure 4.8 illustrates of the force-displacement and force-velocity characteristics of the *gel2* glove material. The force-displacement and force-velocity characteristic curves show nonlinear stiffness behavior in compression and extension, and hysteresis due to dissipated energy, respectively. The figures show the responses under quasi-static and harmonic deformations of the material at 20 and 30 Hz. The results suggest that equivalent stiffness of the material (slope of the force-deflection curve near zero deflection) at 20 Hz is notably higher than the quasi-static stiffness. Further increase in the excitation frequency to 30 Hz, however, resulted in slightly higher stiffness. The energy dissipated by the material is also notably higher under the 30 Hz excitation compared to that under 20 Hz. Similar trends were observed for all the other glove materials, except for the *gel4* glove material, which revealed relatively lower stiffness under the higher frequency excitation.

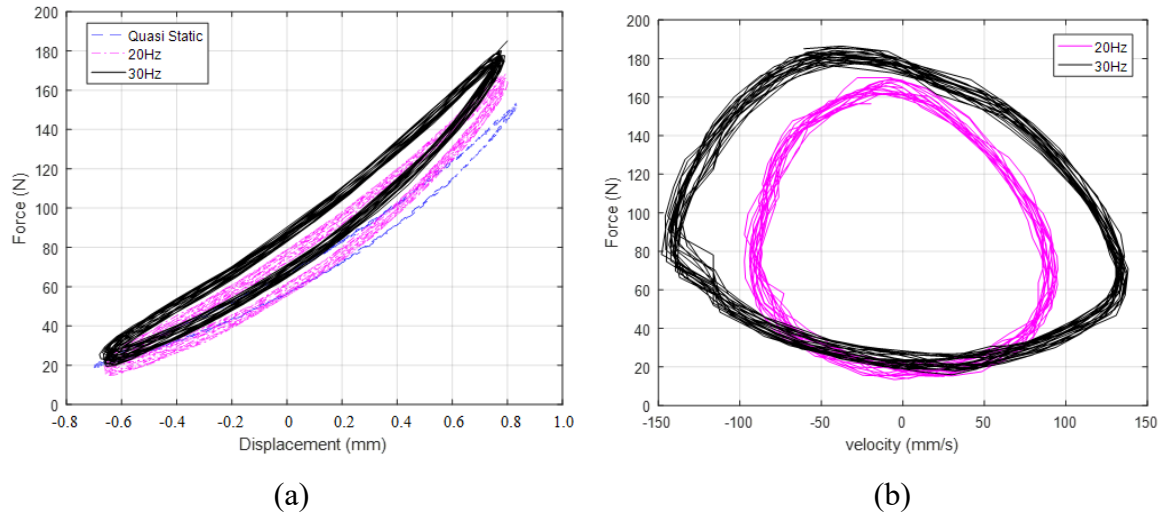

Figure 4. 8: (a) force-displacement; and (b) force-velocity characteristics of the *gel2* glove material under quasi-static and harmonic excitations.

Table 4.5 summarizes the equivalent stiffness (K_{eq}) and damping (C_{eq}) coefficients of the glove material samples. Owing to the different materials used in the palm and fingers regions of the *hybrid* glove, the table presents the properties of materials in both the regions. The dynamic stiffness and damping coefficients of each material were subsequently taken as the means of the values obtained under 20 Hz and 30 Hz excitations. The materials of the gloves within group A (*gel1*, *gel3*, *gel4*, *rubber* and *fabric*), which did not meet the AV glove screening criteria, generally exhibit substantially higher stiffness and damping coefficients compared to those within group B (*air1*, *air2*, *gel2*, *gel5* and *hybrid*). The stiffness of all the glove materials increases with the increase of excitation frequency, except *gel4* glove. However, the damping of these glove materials slightly decreases with the increase of excitation frequency apart from the *rubber* glove. The identified parameters of glove materials will be used to investigate the correlation with vibration transmissibility and dexterity score of the gloves.

Table 4. 5: Equivalent stiffness and damping coefficients of the glove materials

Glove material	K_{eq} (kN/m)			C_{eq} (Ns/m)	
	Quasi-static	20 Hz	30 Hz	20 Hz	30 Hz
<i>gell</i>	629.2	1028.7	1058.1	10.1	9.6
<i>gel2</i>	87.3	102.2	106.6	1.1	0.9
<i>gel3</i>	288.8	419.3	452.4	4.9	3.6
<i>gel4</i>	553.4	528.7	431.6	5.3	2.9
<i>gel5</i>	126.4	163.5	170.5	2.0	1.5
<i>air1</i>	89.6	112.8	117.7	1.1	0.8
<i>air2</i>	71.6	89.9	94.8	0.9	0.7
<i>rubber</i>	525.2	584.5	758.3	6.4	6.4
<i>hybrid_palm</i>	62.3	79.4	84.1	0.9	0.6
<i>hybrid_finger</i>	284.6	482.4	506.6	5.7	5.5
<i>fabric</i>	212.7	255.5	273.0	2.8	2.2

4.3.5 Correlations

In order to comprehensively assess the performance of AV gloves, multiple factors were considered, such as glove material properties, glove thickness, dexterity score and distributed vibration transmissibility at the palm and fingers. Owing to the comparable dexterity scores of all the gloves obtained from the two dexterity test methods, the scores obtained from the ASTM test alone were used to explore the coefficient of determination (R^2) among the multiply factors via linear regression analyses. Figures 4.9 and 4.10 illustrate correlations of the frequency-weighted palm and fingers vibration transmissibility in M- and H- frequency ranges with the glove stiffness and damping coefficients, respectively. The correlations are evaluated considering quasi-static and dynamic stiffness and damping coefficients under 20 Hz and 30 Hz excitations. Results suggest a strong correlation between the glove material properties and palm vibration transmissibility. The palm transmissibility is particularly strongly and positively correlated with the quasi-static stiffness of the material with respective R^2 values of 0.85 and 0.97 in the M- and H-frequency range, respectively. The palm transmissibility is also strongly correlated with the damping coefficients of the material under 20 Hz with respective R^2 values of 0.72 and 0.84 in the M- and H-ranges. However, nearly no correlation is evident between the glove stiffness/damping and the fingers'

vibration transmissibility in the M-frequency, although a moderate correlation between glove properties and index finger vibration transmissibility was found in the H-frequency range. The results suggested that the palm vibration isolation performance of an AV glove is strongly and positively related to the stiffness and damping properties of the glove material.

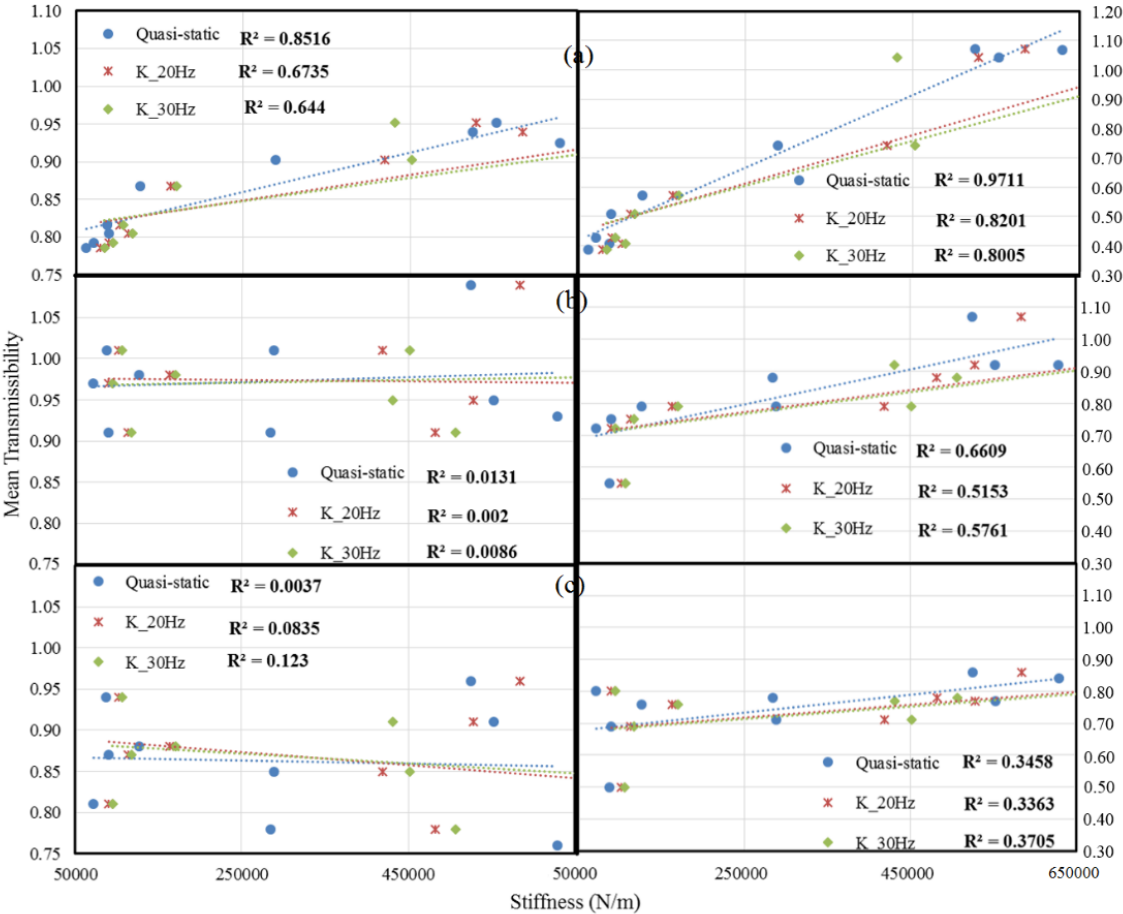

Figure 4. 9: Correlation between the glove material stiffness and the frequency weighted vibration transmissibility of the: (a) palm; (b) index finger; and (c) middle finger in the M- (left column) and H- (right column) frequency ranges.

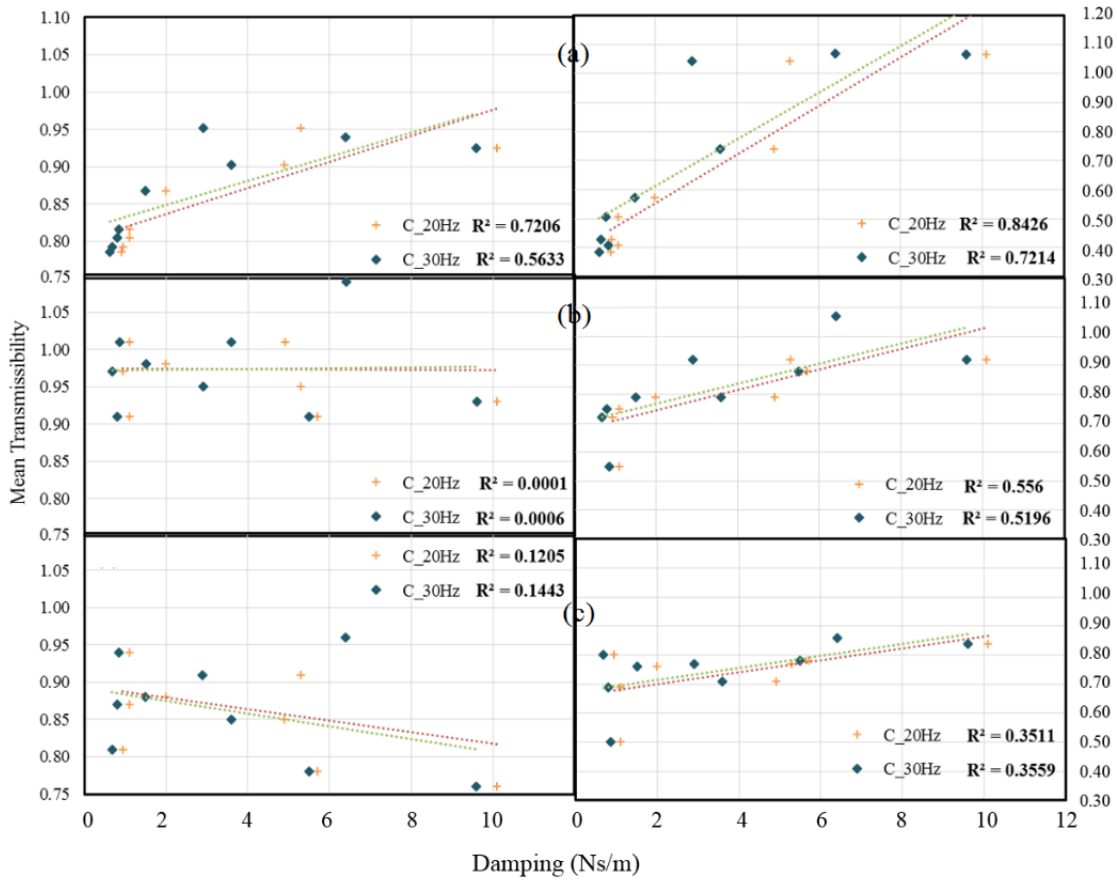

Figure 4. 10: Correlation between the glove material damping coefficient and the frequency weighted vibration transmissibility of the: (a) palm; (b) index finger; and (c) middle finger in the M- (left column) and H- (right column) frequency ranges.

Figure 4.11 illustrates correlations between the glove thickness and the frequency-weighted vibration transmissibility of the palm and fingers in the M- and H- frequency ranges. Increasing the glove thickness generally leads to lower palm and fingers vibration transmissibility values, suggesting that the vibration performance of an AV glove may be enhanced by increasing the glove thickness. The results show relatively strong negative correlations between the glove thickness and the palm and fingers vibration transmissibility in the H-frequency range (R^2 : 0.70-0.86) compared to those in the in M- frequency range (R^2 : 0.23-0.58).

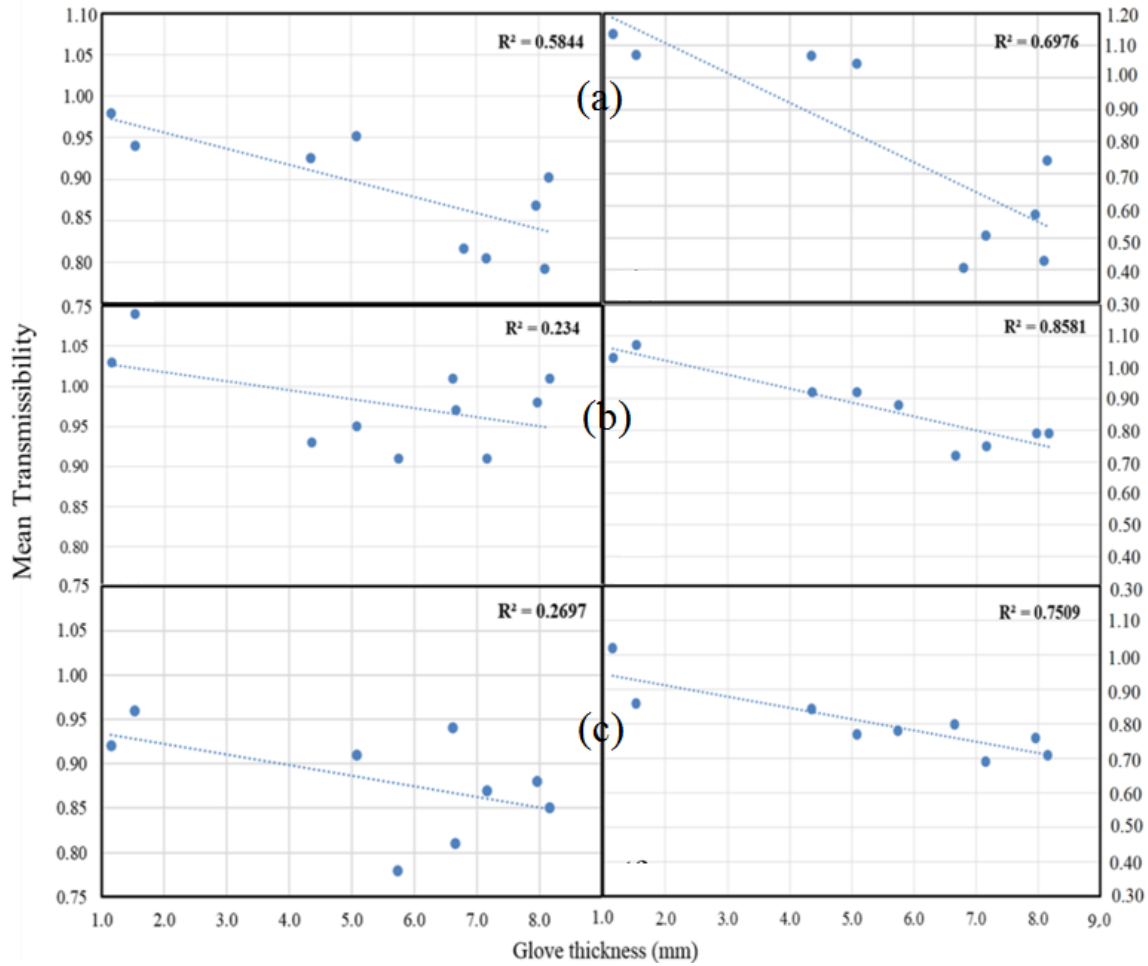

Figure 4. 11: Correlation between the glove thickness and the frequency weighted vibration transmissibility of the: (a) palm; (b) index finger; (c) middle finger in the M- (left column) and H- (right column) frequency ranges.

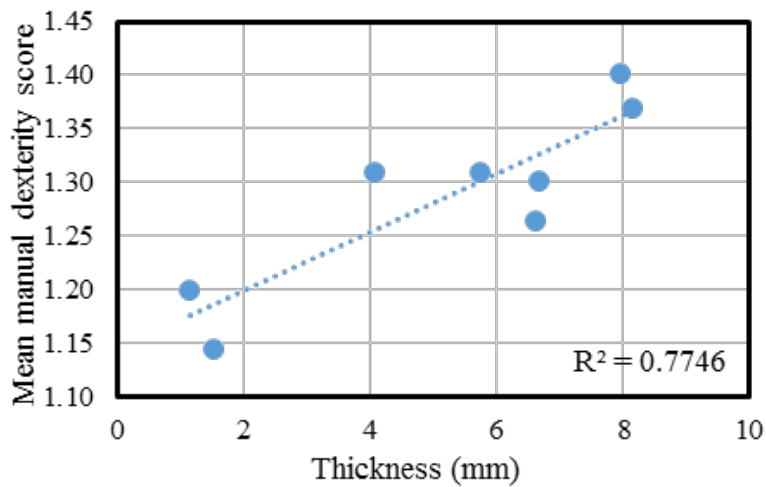

Figure 4. 12: Relationships between glove thickness and manual dexterity for ASTM F2010 test.

In addition, linear regressions were performed between manual dexterity and the frequency-weighted vibration transmissibility of the palm and fingers. Nearly no correlation was found between the palm vibration transmissibility and dexterity score. Relatively small R^2 were obtained for index and middle fingers transmissibility in the M- frequency range, which was 0.43 and 0.27, respectively, as shown in Table 4.6. This suggested a weak correlation between manual dexterity and vibration transmissibility while wearing AV gloves. Figure 4.12 shows a strong correlation between manual dexterity and glove thickness ($R^2=0.77$). The results suggested that the dexterity performance of AV gloves is dependent on the glove thickness. The above-reported correlations were also verified using Pearson’s correlation coefficient in SPSS 22.0. Table 4.6 summarizes the correlations and statistical significance among the factors considered.

Table 4. 6: Correlations (R^2) among the glove material properties, thickness, dexterity and vibration and H-range palm and fingers vibration transmissibility

	Dexterity score	Thickness	Quasi-static	K_{eq}		C_{eq}	
				20 Hz	30 H	20 Hz	30 Hz
TR_Palm_M	0.04	0.58*	0.85**	0.67*	0.64*	0.72*	0.56
TR_Palm_H	0.02	0.70*	0.97**	0.82*	0.80*	0.84*	0.72
TR_Index finger_M	0.43	0.23	0.01	0.00	0.01	0.00	0.00
TR_Index finger_H	0.13	0.86**	0.66*	0.52	0.58	0.57	0.52
TR_Middle finger_M	0.27	0.27	0.00	0.08	0.12	0.35	0.36
TR_Middle finger_H	0.04	0.75*	0.35	0.34	0.37	0.35	0.30
Dextertiy_A	--	0.78	0.03	0.16	0.09	0.14	0.10

* $p < 0.05$; ** $p < 0.01$

4.4 Discussions

4.4.1 Vibration isolation and manual dexterity performance of AV gloves

The AV gloves need to be assessed in terms of their integrated performance including the palm and fingers’ vibration isolation, and their proficiency in preserving the grip strength and the manual dexterity. The studies reporting assessments of AV gloves have mostly explored these measures in an independent manner. These are mostly focused on the palm vibration transmission since it is

required for the classification of a glove as an anti-vibration glove [11], although the fingers vibration has also been studied in a few recent studies [3, 5]. Studies have also shown that the AV gloves adversely affect the grip strength, which generally did not consider the vibration isolation performance [3, 5]. The dexterity performance of AV gloves, on the other hand, has been investigated in a single study without the consideration of the vibration or grip strength performance [2]. The transmission of vibration distributed to the palm and fingers reported in this study revealed considerably higher inter-subject variability in mean vibration transmissibility, which may be partly attributed to differences in the hand size of the subject. Variations in the hand size directly affect the effective contact area and thus the mean contact force, which has been shown to influence the vibration transmission performance of the AV gloves and the materials [9, 160]. Welcome et al. [109] suggested that the inter-subject variability can be reduced by ensuring similar same hand size of the subjects. The hand size of the participants in this study ranged from 8 to 10, which was within the range (7 to 10) recommended in ISO 10819 [11].

Moreover, substantially higher variability was evident at higher excitation frequencies (H-frequency range), regardless of the glove type and the measurement location. The CoV of the mean w_p -weighted fingers' vibration transmissibility in H-frequency range was particularly higher, ranging from 16% to 30%. This is in part due to considerably higher dominant frequencies of fingers' vibration (middle finger: 125.0 to 187.8 Hz; index finger: 109.6 to 154.7 Hz) compared to those of the palm vibration (25.0 to 28.3 Hz), as reported in Table 4.3. It is also known that the high-frequency vibration becomes more localized to the hand and fingers, while the low-frequency vibration is transmitted to the forearm and the upper arm [65]. The high-frequency vibration also contributes to variations in the contact force between the fingers of the glove hand and the handle [160], and involuntary variations in the hand grip and push forces, which also contribute to variations in the transmitted vibration [10]. The large variability in transmissibility to the finger has also been reported in [3, 6, 10]. Substantially lower variability in the palm-transmitted vibration compared to that of the fingers, observed in the study, is likely due to more uniform contact of the palm region with the handle, and differences in the mechanical impedance of the fingers and palm [163, 164]. Moreover, the fingers adapters used in the study may constitute an intrinsic variation.

The results obtained from ANOVA (Table 4.4) also showed the subjects had no significant difference ($p=0.113$) on the palm vibration transmissibility, while the statistically significant difference was evident on the fingers' vibration transmissibility ($p<0.001$). The current

standardized method [11], focused only on the palm vibration transmissibility, requires measurements with 5 subjects for the screening of AV gloves. The results suggest that the number of subjects used in such experiments is not statistically significant. The current as well as many reported studies [3, 6, 10] have employed a greater number of subjects with an expectation to achieve more reliable evaluations of AV gloves in addition to consideration of variations in the hand sizes. The CoV values of the mean palm vibration transmissibility of the *air1*, *air2* and *hybrid* gloves showed comparable but highest variability regardless of the frequency weightings (Table 4.2), which are consistent with the data reported in [3, 6]. The same air-bladder AV material is used in the palm regions of these gloves, which further explained their comparable variability.

The above-stated gloves, however, showed very good and comparable vibration isolation performance for the palm in the entire frequency range, and satisfied the screening criteria [11]. While assessing the vibration isolation performance of AV gloves according to mean transmissibility in M- and H-frequency ranges may not be relevant to the operators in the field. Griffin [165] evaluated the effectiveness of the ten gloves in reducing the hand-transmitted vibration with 20 different power tools and reported that the spectra obtained from 20 different vibratory tools with the spectra M- and H- frequency range is not similar to the spectra defined in the ISO 10819 [11]. It suggests that the mean transmissibility, as shown in Figure 4.4, cannot be assumed to indicate the real attenuation of vibration when the glove is used with a specific tool in the field.

The results of the study also showed superior palm vibration isolation performance of these gloves in addition to the *gel2* and *gel5* gloves (group B), which could be attributed to their relatively low stiffness and damping coefficients (Table 4.5). The gloves within group A (*rubber*, *fabric*, *gel1*, *gel3* and *gel4*), on the other hand, exhibited substantially higher stiffness and higher palm transmitted vibration. The palm thickness of the gloves within group B (about 6.7 to 8.0 mm) was considerably greater than those of the gloves within group A (1.1 to 4.4 mm), with the exception of the *gel3* glove. Increasing the material thickness caused lower stiffness and thus improved the palm vibration isolation performance. Md Rezali and Griffin [8] showed that the material thickness influences the dynamic stiffness and apparent mass at the palm and finger as well as the transmission of vibration to the palm and the fingers. The lightly damped and low stiffness gloves within group A, however, revealed relatively higher peak transmissibility (1.04-1.09) in the 25.00 to 28.33 Hz range compared to those of the gloves within group B. Most of the gloves revealed

either minimal attenuation or amplification of handle vibration transmitted to the fingers in the M-frequency range. All of the gloves within group B showed comparable vibration transmission to the fingers in the entire frequency range, with the exception of the *gel2* glove. The *gel2* glove, made of gel with pores, showed the greatest attenuation of handle vibration transmitted to the fingers in the H- frequency range with only slight amplification in the M- frequency range (Table 4.2). Hamouda et al. [3] and Welcome et al. [6] reported that the gel-filled glove designs are more effective in reducing the high-frequency finger vibration than the air-bladder designs. All the gloves within group A showed better vibration isolation performance at the middle finger than that at the index finger in the 25-400 Hz frequency range, while comparable vibration transmission was observed for both the fingers with gloves within group B. Moreover, the subject, the glove type and the frequency range showed significant influence on the w_p -weighted fingers' vibration transmissibility ($p<0.05$), as illustrated in Table 4.4.

The mean manual dexterity scores of all the AV gloves were in excess of unity value, suggesting that all the gloves impede manual dexterity. The *fabric* and *rubber* gloves revealed the lowest dexterity, while the relatively thick *air1* and *gel5* gloves showed the worst dexterity scores (Table 4.1). The *gel1* glove with high material stiffness also showed poor dexterity performance. The results showed a statistically significant difference in view of the glove type ($p<0.001$), as seen in Table 4.4. While the test method had no significant effect on the manual dexterity ($p=0.112$). The dexterity score was significantly and positively correlated with the glove thickness ($p<0.05$). Although *air1* and *air2* gloves comprised identical air-bladder vibration isolation material, their dexterity scores differed considerably (1.73 for *air1* and 1.30 for *air2*). This was partly attributed to the difference in their thickness and in-part to the design of the covering. The *air2* and *hybrid* gloves revealed comparable dexterity scores, which was attributed to their identical covering. Moreover, the *gel2* glove with a thickness comparable to those of the *air2* and *hybrid* gloves showed similar dexterity score.

Both the dexterity and vibration isolation performance of AV gloves showed an important effect of the glove material thickness. Lower stiffness could be generally achieved by increasing material thickness, which showed a beneficial effect in view of the palm vibration isolation performance. The moderate positive correlation (R^2 : 0.34-0.66) between the glove material stiffness and the fingers' vibration transmissibility, however, suggests that increasing the glove material stiffness also adversely affects the fingers vibration attenuation performance of AV gloves. While

the correlation between the dexterity score and the glove stiffness was absent, the dexterity score was strongly and positively correlated with the glove thickness (R^2 : 0.78). The *gel5* glove, made of two layers of gel covered by stiff pigskin leather (thickness: 8.0 mm), passed the screening criteria based on the palm vibration transmissibility but showed relatively poor manual dexterity performance (dexterity score=1.4). The *gel3* glove with the thickness (8.2 mm) comparable to that of the *gel5* also revealed similar manual dexterity score (1.43). These further confirm that the dexterity performance of a glove is directly related to its thickness. These two gloves also showed comparable w_p -weighted fingers' vibration transmissibility in the entire frequency range, although *gel3* did not satisfy the AV glove screening criteria in the H-frequency range.

The *gell* (4.4 mm) and *gel4* (4.3 mm) gloves showed quite a comparable vibration transmissibility, irrespective of the frequency weighting and the measurement location. The *gell* glove also showed nearly unity palm vibration transmissibility in the entire frequency range, suggesting minimal or no vibration attenuation. It may be due to the highest stiffness and damping of the glove among all the gloves (Table 4.5). Despite the comparable thickness, the dexterity scores of these two gloves differed. Poor dexterity score of the *gell* glove (dexterity score =1.51) was attributed to excessive width of the fingers' sections together with very stiff seams, which caused considerable extra space around the fingertips. The dexterity performance of a glove is also related to the bulkiness of the glove design, apart from the glove thickness [2].

The thin designs of the *fabric* and *rubber* showed lowest dexterity score but negligible vibration isolation. The superior dexterity was attributed not only to the lower thickness but also the superior fitting of the gloves. Moreover, these gloves revealed considerably lower inter-subject variability of the vibration transmissibility in the entire frequency range, regardless of the frequency weighting and the measurement location. This is likely due to more uniform and steady hand contact with the handle due to good fitting. The stiffness and damping of the AV glove material, and the apparent mass of the hand at the palm and the thenar eminence in the high-frequency range increases with increase in the contact area, which leads to higher vibration transmissibility of the glove [9].

4.4.2 Glove design guideline

The results of the study suggest that it is possible to design an AV glove that can provide adequate anti-vibration property, while preserving the manual dexterity performance. This is vital for promoting the usage of AV gloves at the workplace. In general, the vibration isolation performance of an AV glove is predominantly dependent on the stiffness and damping properties of the glove

material, and material thickness in the palm region. Relatively lower stiffness and damping of the glove material is highly beneficial in limited the vibration transmission to the palm. The dexterity performance of the glove, on the other hand, is not affected by the material stiffness and damping properties. The material properties thus constitute design parameters independent of the dexterity performance. Lower stiffness is generally realized by increasing the material thickness, which is believed to affect the dexterity adversely. The manual dexterity, however, is predominately affected by the material thickness in the fingers' region. Increasing the glove material thickness at the palm can thus effectively improve the vibration isolation performance without impeding the fingers dexterity. The vibration transmission characteristic at the palm and fingers exhibit significant differences, particularly with regards to the dominant frequencies of transmitted vibration. Glove designs with different thickness and properties of materials in the palm and fingers regions may help realize improved integrated performance, including the palm and fingers' vibration transmissibility, and the manual dexterity. Such a design approach, however, is not supported by the current AV gloves screen criteria, defined in ISO standard [11]. In addition, soft covering material of the glove in the working surface with non-slip texture could facilitate more precise grasping of the smaller objects.

4.5 Conclusions

All the gloves impeded dexterity when compared to bare-handed performance, while only five of the test gloves satisfied the screening criteria of the ISO 10819 (2013) based on the palm vibration alone. The AV gloves provided either minimal attenuation or amplification of vibration transmitted to the fingers in the M-frequency range (25-200 Hz) with limited isolation in the H-frequency range (200-1250 Hz). The AV gloves are thus less effective in protecting the fingers from vibration than they are in protecting the palm. The correlation between the manual dexterity and the palm vibration was not evident since the palm vibration is mostly influenced by the mechanical properties and thickness of the material in the palm region. There were strong correlations between the glove material stiffness and the palm vibration transmissibility, which was more pronounced in the H-frequency range ($R^2 > 0.80$). A weak correlation between the manual dexterity and the fingers' vibration transmissibility of the AV gloves was observed ($R^2: > 0.27$ to 0.43). The dexterity performance on the other is influenced by the material thickness in the fingers' region. Strong positive correlations were observed between the palm vibration isolation and the material properties and thickness in the entire frequency range. A similar correlation was also evident for the high-

frequency finger vibration isolation with the glove material thickness ($R^2 \geq 0.75$). The manual dexterity decreased nearly linearly with increase in the glove thickness. The dexterity performance of the AV gloves was further affected by the glove design factors such as bulkiness and the degree of the fitting.

CHAPTER 5: MEASUREMENT OF FOREARM MUSCLE ACTIVITIES TO STUDY ANTI-VIBRATION GLOVES: SENSITIVITY AND CONSTRUCT VALIDITY ISSUES

5.1 Introduction

Relatively thick vibration reducing materials used in AV gloves generally impede the grip strength. AV gloves require a relatively higher grip exertion by the operators using power tools [3, 16, 107, 109]. Higher grip effort demand can increase the risk of hand-arm musculoskeletal disorders [100, 102, 166]. The performance of AV gloves is mostly assessed in terms of attenuation of handle vibration transmitted to the palm and fingers of the hand [3, 6], while the effects on manual dexterity and grip strength have been addressed in only a few studies [2, 3, 16, 107, 109].

The primary aim of the present study is to assess the effect of AV gloves on muscles' activities using a surface EMG methodology. The activities of four muscles of the dominant forearm of 15 subjects were measured while grasping with a constant grip force (25 N and 50 N) with and without the AV glove. The data obtained for 10 different gloves, including 9 AV gloves, were used to identify at which grip force amplitude and which forearm muscles are most sensitive to AV gloves in case of a power grip condition. The normalized activity of muscles (NRMS) were analyzed and described as the ratio of the root mean square of gloved hand and that of bare hand. The main effects of glove type, grip force and their interactions on the NRMS of individual muscle and the combined muscles were evaluated via two-factor repeated-measures analysis of variance. The effect size was also calculated using the Cohen's *d* values to investigate an interpretation of the significance of the detected effects. Moreover, Tukey HSD (honest significant difference) post hoc analysis was performed to detect difference among the glove types. In addition, the Pearson's correlation coefficient between glove properties (manual dexterity, thickness and stiffness) and the NRMS values of the combined extensor carpi radialis longus (ECR) and flexor carpi radialis (FCR) muscles were evaluated to study the construct validity between the glove properties and the muscle activities. The detailed statistical analyses methods used in this study are presented in the Appendix A. A better understanding of the effects of anti-vibration gloves on forearm muscles activities can yield essential design guidance for anti-vibration gloves and a possible measure of grip exertion by gloved hand.

5.2 Experimental Methods

5.2.1 Subjects and gloves

Fifteen adult male subjects were recruited for the experiments. Subjects were also questioned regarding their previous history of any hand or wrist trauma, and those with a recent injury or cumulative trauma disorders were excluded from the study. All subjects were informed of the experimental protocol and its potential risks and gave written consent prior to their participation. The experiment protocol was approved by the Human Research Ethics committee of Concordia University.

Ten different gloves considered for the study are pictorially shown in Figure 5.1. These are the same with the gloves used in the dexterity (chapter 2) and vibration isolation tests (chapter 4). The AV gloves included: 5 gloves with gel vibration isolation materials, denoted as *gel1*, ..., *gel5*; two gloves with air bubble vibration isolation material, denoted as *air1* and *air2*; one hybrid glove, comprising air bubble vibration isolation material in the palm region and gel in the fingers' regions, denoted as *hybrid*; and one rubber glove, denoted as *rubber*. Gloves with sizes ranging from small to extra-large were made available to the subjects. Participants were advised to try different sizes of each glove and select an appropriate size that fits well and permits adequate fingers and hand movements. The fitting of the glove was further examined by the experimenter by ensuring minimal protrusion of the glove material beyond the fingertips.



Figure 5. 1: The gloves used in this study

5.2.2 EMG Assessments

A familiarization session was initially held to ensure that the subject could perform the desired grip effort and to identify the hand size in accordance with EN 420 [121], which was followed by the EMG assessments on the same day for the participant retained for the study. The dexterity assessments of the same AV gloves were performed in an earlier study [2] (chapter 2).

Anthropometric data of the dominant hand were collected for each of the subjects, namely, the hand length, hand circumference, fingers' length and hand size in accordance with the EN 420 standard [121]. These are summarized in Table 5.1 together with the means and standard deviations (*SD*). The hand size of the participants ranged from 8 to 10 (mean size \approx 9; $SD = 0.72$).

Table 5. 1: Hand dimensions of the participants

Subject	Length (mm)						Hand circumference (mm)	Hand size
	Hand	Thumb	Index finger	Middle finger	Ring finger	Little finger		
1	194	72	74	85	77	61	223	9
2	211	77	81	92	81	66	209	10
3	196	75	84	80	71	66	198	9
4	190	72	85	80	62	63	201	8
5	185	79	82	72	60	64	186	8
6	194	72	85	79	63	70	220	9
7	200	78	88	80	65	74	213	9
8	188	71	75	80	75	57	225	9
9	185	73	80	74	60	72	210	8
10	195	75	80	75	60	70	210	9
11	194	78	76	83	76	65	214	9
12	193	77	75	81	71	58	230	10
13	206	67	75	85	80	60	230	10
14	182	60	71	78	72	57	220	8
15	193	76	82	75	61	71	200	8
Mean	193.7	73.5	79.5	79.9	68.9	64.9	212.6	8.9
SD	7.45	4.79	4.79	4.89	7.48	5.42	12.16	0.72

The muscle activation was measured for four main muscles of the forearm whilst performing stationary grip effort, namely, flexor carpi radialis (FCR), flexor digitorum superficialis (FDS),

extensor carpi radialis longus (ECR), and extensor digitorum (ED). Electrodes were attached to the skin after it had been shaved and cleaned using alcohol. Each electrode was positioned in accordance with suggestions by Basmajian and Blumenstein [167]. Briefly, the electrodes were placed on the FCR and FDS around the 50% point on a line from the lateral aspect of the biceps tendon at the elbow crease to the pisiform bone, and from the medial epicondyle to the styloid process of ulna, respectively. The electrodes of the ECR and ED muscles were positioned around the 1/3 point on the line from the lateral end of the elbow crease to the middle of the wrist, and the 1/4 point on a line drawn from the lateral epicondyle to the styloid process of the ulna, respectively, with the forearm fully pronated [167]. A reference electrode was positioned over the tibia.

After the electrodes were positioned, the subject was seated on a chair with back support, and forearm positioned horizontally (semi-pronated) on the surface of a table with wrist on the edge of the table. The table was adjustable in height so that an elbow angle of about 120° and a small shoulder abduction of about 15° could be achieved. Figure 5.2 illustrates the experimental setup and the subject's posture. The dynamometer handle (diameter: 40 mm) integrated two force transducers for measuring the grip effort of the subject [18]. The handle was positioned freely on the table in order to ensure that the generated effort was in grip only. Measurements were performed under two levels of pure grip force imposed by the subject on the dynamometer: 25 N and 50 N. The signal from the grip sensors was displayed on a monitor positioned at the eye level of the subject, which permitted the subject to apply the desired grip effort within ± 5 N. The order of the hand conditions and grip effort was randomized to minimize the learning effect. The subject was required to maintain the desired static grip effort for 5 s, and each test was performed 3 times so as to examine repeatability and ensure accuracy of the measurements. Subjects were given a 30 s rest between successive trials and 1 minute rest when the hand condition changed.

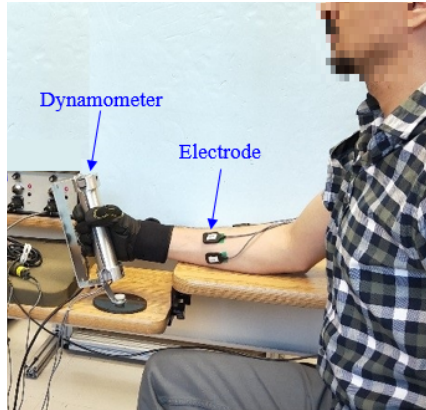

Figure 5. 2: Experimental setup and subject's posture.

The EMG signals were collected with a Bagnoli™-16 system (DS-B04; Delsys Inc., Wellesley, MA) and 4 differential dry surface electrodes (Model DE-2.1, Delsys Inc., Wellesley, MA). The bandwidth of EMG signals ranged from 20 ± 5 Hz to 450 ± 50 Hz. EMG signals were A/D converted at a sampling rate of 4096 Hz and stored using the 24-bits B&K Connect platform.

5.2.3 Mechanical tests

The attributes of each glove were measured in terms of material thickness and static stiffness in chapter 4 to evaluate their effects on the muscles' activities. Briefly, samples of palmar side glove materials in the palm and fingers sections were cut for each glove, and their undeformed thickness was measured using a caliper. Each sample without the covering layer was subsequently placed on the platform of an electro-hydraulic vibration exciter for characterizing its static stiffness. The force-deflection data acquired for each material sample were analyzed to estimate quasi-static stiffness of each material. It should be noted that all the gloves, with the exception of the *hybrid* glove, comprised identical material in the palm and fingers region with nearly identical thickness. The stiffness of materials in both the regions was thus also identical, with the exception of the *hybrid* glove. Table 5.2 summarizes the glove material thickness and quasi-static stiffness for each glove. The manual dexterity score of these gloves were presented in chapter 2.

5.2.4 Data processing and statistical analyses

In order to further assure the quality of the EMG results, only the closest two trials (out of three) were used for further analysis. The EMG signals were preamplified (gain 1000) during the acquisition and processed via a bandpass filter (30-450 Hz), as described in [115]. The data were analyzed to determine the root mean square (RMS) value for each trial. The mean RMS values of

each muscle obtained for the gloved hand and a given grip force were normalized with respect to those obtained for the BH condition under the same grip force, such that:

$$\text{NRMS}_i = \frac{\text{RMS}_{GV}}{\text{RMS}_{BH}} \times 100 \quad (5.1)$$

Where, NRMS_i is the normalized activity of muscle i ($i=1,\dots,4$), which describes its relative level of activation. RMS_{GV} and RMS_{BH} are the EMG activation amplitudes obtained with the gloved and bare hand conditions, respectively. According to previous findings showing differences in the sensitivity and reliability of composite indices [18], we also created other NRMS scores by averaging the scores of different muscle pairs and the averaging of all muscles (X-all). However, for conciseness, based on all statistical analyses, only the results corresponding to the ECR-FCR pair, which is the most sensitive combination to glove effects, as well as X-all, as an additional reference, will be reported. Considering that this way to normalize EMG (RMS_{BH} as denominator) is different with using maximal EMG values, it was of interest to verify whether using RMS_{BH} corresponding to different grip efforts would make differences in the scores (should not) and in terms of sensitivity to glove conditions. Two grip efforts, 25 and 50 N, were evaluated. This means that RMS values corresponding to 25 N were normalized to the 25 N bare hand condition (RMS_{BH_25N}) and RMS values at 50 N with RMS_{BH_50N} .

Two-way repeated-measures analysis of variance (rANOVA) were conducted to evaluate the main effects of glove type, grip force and their interactions on the NRMS values of individual muscle and different combinations of the muscles. The grip force (2 levels) and glove type (10 levels) were considered as the independent variables, while the dependent variable included the NRMS values of each muscle or their combinations. In order to investigate a clearer interpretation of the significance of the detected effects, the effect size was calculated using the Cohen's d values. Values of $0.2 \leq d \leq 0.5$, $0.5 \leq d \leq 0.8$ and $d > 0.8$ were respectively considered to denote the effect as "small", "medium," and "large" [168]. Wherever applicable, Tukey HSD (honest significant difference) post hoc analysis was performed to detect difference among the glove types. In addition, the Pearson's correlation coefficient between glove properties (dexterity, thickness and stiffness) and the NRMS values of ECR_FCR muscles were evaluated to study the construct validity between the glove properties and the muscle activities.

5.3 Results

5.3.1 Sensitivity of the surface EMG methodology to AV gloves

Assessment with descriptive statistics

Table 5.2 summarizes mean, standard deviation and coefficient of variation of NRMS values of the mean of all four muscles (X-all) obtained for 15 subjects and each glove. Gloves invariably cause a notable increase in the X-all compared with the bare hand condition, which ranged from 28% to 57% and 21% to 61% for 25 N and 50 N grip forces, respectively. All the AV gloves revealed substantially higher muscles activation compared to the protective (*fabric*) glove, irrespective of the grip force level. The *fabric* glove resulted in minimal increase in the X-all (28% and 21% for 25 N and 50 N grip effort, respectively), while the *gel5* (57%) and *air1* (60%) gloves showed greatest increase under both grip efforts (25 N and 50 N). The *rubber* glove also revealed considerably lower muscles' activation compared to the other AV gloves. The comparable increase in muscle activities (36-49%) were obtained due to *gel4*, *gel2*, *air2*, *gel1*, *hybrid* and *gel3* gloves (Table 5.2), irrespective of grip force.

Table 5. 2: Mean, standard deviation (SD) and coefficient of variation (CoV) of normalized forearm muscles activities (X-all) and mean dexterity score of 15 subjects for each glove, and properties of gloves

Glove type	Total normalized muscles activities (X-all)						Glove thickness (mm)	Glove stiffness (kN/m)	Dexterity score
	Grip force= 25N			Grip force= 50N					
	Mean (%)	SD (%)	CoV (%)	Mean (%)	SD (%)	CoV (%)			
<i>fabric</i>	128	17	14	121	19	16	1.2	212.7	1.16
<i>rubber</i>	135	22	16	132	19	14	1.5	525.2	1.32
<i>gel4</i>	140	22	16	136	14	10	4.1	553.4	1.28
<i>gel2</i>	144	32	22	139	27	20	6.6	87.3	1.35
<i>air2</i>	141	26	18	140	23	16	6.7	71.6	1.35
<i>gel1</i>	146	34	23	142	19	13	4.4	629.2	1.54
<i>hybrid</i>	143	17	12	142	24	17	5.7 ¹ (8.1 ²)	284.6 ¹ (62.3 ²)	1.40
<i>gel3</i>	149	35	23	142	24	17	8.2	288.8	1.36
<i>gel5</i>	157	31	20	150	26	17	8.0	126.4	1.63
<i>air1</i>	153	37	24	161	30	19	7.2	89.6	1.70

Thickness and stiffness of material in the fingers¹ and palm² regions

Assessment with inferential statistics:

Two-way rANOVA results showed that the grip force magnitude and grip force*glove type interaction have no significant effect on NRMS values of muscles' activities, while glove type revealed a significant effect ($p < 0.001$) on NRMS values of ECR, FCR, ECR_FCR and X-all, as

shown in Table 5.3. The results from the Tukey HSD post hoc tests were used to identify the number (N) of significant differences between gloves in order to obtain an insight into the sensitivity of the normalized muscle activities. A total of 5, 10, 16 and 9 significant differences were detected for the ECR, FCR, ECR_FCR and X-all, respectively, as shown in Table 5.3. The effect sizes corresponding to these significant differences ($N = 40$ in all) varied between 0.52 and 1.60, with a “medium” effect ($0.52 \leq d \leq 0.80$) in 40% ($N = 16$) of the cases, and a “large” effect ($d \geq 0.80$) in 60% ($N = 24$) of the cases.

Table 5. 3: Two-way rANOVA results obtained for four individual muscles, and ECR_FCR and the mean of four muscles (X-all).

NRMS	2-way rANOVA (p)			Post hoc test (Tukey HSD)	
	Glove type	Grip force	Glove *force	N	Significant differences between gloves (d : Cohen)
ECR	0.000	0.69	0.28	5	<i>fabric & gel5</i> ($d = 0.83$); <i>fabric & air1</i> ($d = 1.20$); <i>rubber & air1</i> ($d = 0.91$); <i>gel2 & air1</i> ($d = 0.77$); <i>gel1 & air1</i> ($d = 0.62$);
ED	0.30	0.34	0.83	/	
FCR	0.000	0.79	0.30	10	<i>fabric & gel4</i> ($d = 0.91$); <i>fabric & gel2</i> ($d = 0.71$); <i>fabric & air2</i> ($d = 0.87$); <i>fabric & gel1</i> ($d = 0.80$); <i>fabric & hybrid</i> ($d = 0.89$); <i>fabric & gel3</i> ($d = 0.77$); <i>fabric & gel5</i> ($d = 1.10$); <i>fabric & air1</i> ($d = 1.26$); <i>rubber & air1</i> ($d = 0.82$); <i>gel2 & air1</i> ($d = 0.52$)
FDS	0.80	0.32	0.26	/	
ECR_FCR	0.000	0.91	0.65	16	<i>fabric & gel4</i> ($d = 0.93$); <i>fabric & gel2</i> ($d = 0.75$); <i>fabric & air2</i> ($d = 0.94$); <i>fabric & gel1</i> ($d = 0.82$); <i>fabric & hybrid</i> ($d = 0.94$); <i>fabric & gel3</i> ($d = 0.91$); <i>fabric & gel5</i> ($d = 1.23$); <i>fabric & air1</i> ($d = 1.60$); <i>rubber & air1</i> ($d = 1.08$); <i>rubber & gel5</i> ($d = 0.72$); <i>air1 & gel4</i> ($d = 0.93$); <i>air1 & gel2</i> ($d = 0.81$); <i>air1 & air2</i> ($d = 0.72$); <i>air1 & gel1</i> ($d = 0.69$); <i>air1 & hybrid</i> ($d = 0.64$); <i>air1 & gel3</i> ($d = 0.60$);
X-all	0.000	0.73	0.15	9	<i>fabric & gel2</i> ($d = 0.67$); <i>fabric & air2</i> ($d = 0.74$); <i>fabric & gel1</i> ($d = 0.73$); <i>fabric & hybrid</i> ($d = 0.86$); <i>fabric & gel3</i> ($d = 0.81$); <i>fabric & gel5</i> ($d = 1.12$); <i>fabric & air1</i> ($d = 1.09$); <i>rubber & air1</i> ($d = 0.69$);

		<i>rubber & gel5 (d = 0.70);</i>
--	--	--------------------------------------

Figure 5.3 presents the mean and standard errors of NRMS values of ECR and FCR together with ECR_FCR and X-all obtained for different gloves and two grip conditions. The results obtained for the ED and FDS muscles are not presented, since these muscles showed no significant difference on glove type (Table 5.3).

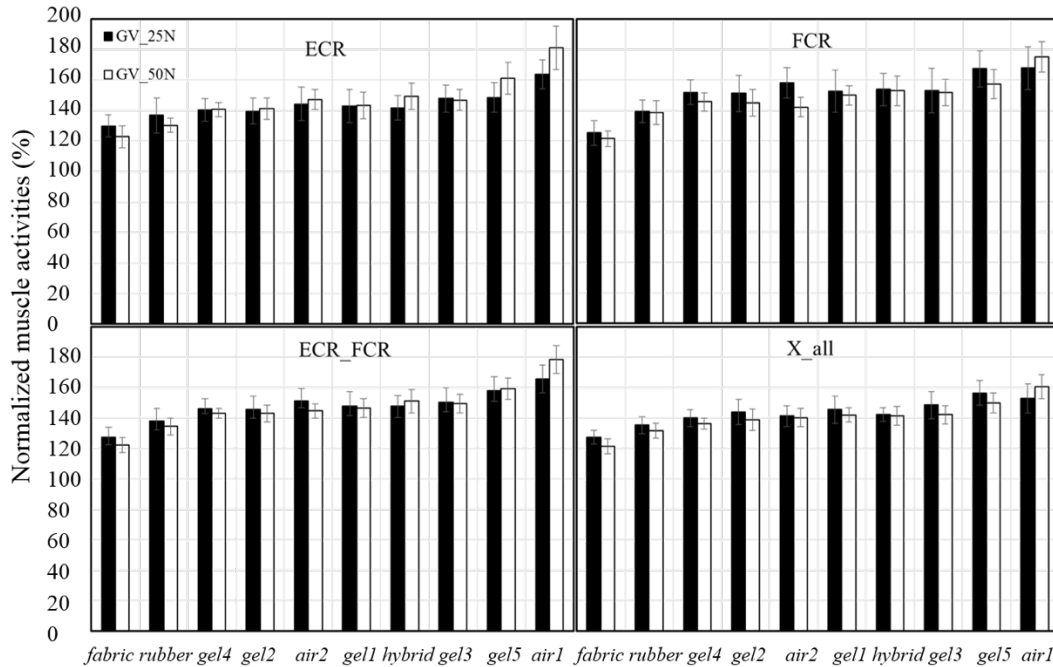

Figure 5. 3: Mean normalized activities of ECR, FCR, ECR_FCR and the mean of the four muscles (X-all) obtained for each glove and two levels of grip force (25 N and 50 N).

The NRMS values of the ECR muscle showed the lowest increase in activities (23-30%) for the *fabric* glove followed by the *rubber*, while the largest increases were observed for the *air1* (64-81%) and *gel5* (49-61%) gloves. The remaining gloves showed comparable NRMS values, ranging from 40% to 49%, irrespective of the grip force. Comparable trends were also observed in the NRMS values of FCR (*fabric*: 22-25%; *air1*: 68-75%; *gel5*: 57 -67%), ECR_FCR (*fabric*: 22-28%; *air1*: 66-79%; *gel5*: 58 -59%) and mean of four muscles (*fabric*: 21-28%; *air1*: 53-61%; *gel5*: 50-57%). The rest of gloves show comparable muscle activities ranging from 45% to 58%, 43% to 60%, 36% to 49%, for the FCR, ECR_FCR and the mean of the four muscles, respectively, irrespective of the grip force.

Subsequently, one-way rANOVA (Table 5.4) was performed to compare the gloves considering each grip effort independently (25 N and 50 N), in order to simulate the use of a lighter protocol and to check if the protocol with a force of 50 N is more sensitive to the glove effect than that with a force of 25 N. The results revealed a greater number of significant differences for 50 N grip ($N=38$) compared to those for the 25 N grip ($N= 22$), as shown in Table 5.4. The corresponding effect sizes were also higher with the 50 N protocol ($0.72 \leq d \leq 2.04$) compared to the 25 N protocol ($0.55 \leq d \leq 1.21$). The combination ECR_FCR produced the greatest number of differences, as it was observed from two-way rANOVA analysis (Table 5.3). The measurement of ECR_FCR muscle activities with 50 N grip can thus be considered as the most sensitive strategy for investigating the effect of AV glove on muscles activation, with 15 significant differences accompanied by the highest effect sizes ($0.97 \leq d \leq 2.04$).

Table 5. 4: One-way rANOVA results obtained for four individual muscles, and ECR_FCR and the mean of four muscles (X-all) for two levels of grip.

Muscle	One-way rANOVA		Post hoc test (Tukey HSD)
	(<i>p</i>)	<i>N</i>	Significant differences between gloves (<i>d</i> : Cohen)
	Glove type		
Grip force = 25 N			
ECR	0.043	2	<i>fabric & air1</i> ($d = 0.97$); <i>rubber & air1</i> ($d = 0.62$)
ED	0.14	-	
FCR	0.000	9	<i>fabric & gel4</i> ($d = 0.8$); <i>fabric & gel2</i> ($d = 0.62$); <i>fabric & air2</i> ($d = 0.88$); <i>fabric & gel1</i> ($d = 0.61$); <i>fabric & hybrid</i> ($d = 0.74$); <i>fabric & gel3</i> ($d = 0.59$); <i>fabric & gel5</i> ($d = 1.02$); <i>fabric & air1</i> ($d = 0.92$); <i>rubber & air1</i> ($d = 0.63$)
FDS	0.33	-	
ECR-FCR	0.000	10	<i>fabric & gel4</i> ($d = 0.72$); <i>fabric & air2</i> ($d = 0.80$); <i>fabric & gel1</i> ($d = 0.63$); <i>fabric & hybrid</i> ($d = 0.73$); <i>fabric & gel3</i> ($d = 0.70$); <i>fabric & gel5</i> ($d = 0.95$); <i>fabric & air1</i> ($d = 1.21$); <i>rubber & gel5</i> ($d = 0.55$); <i>rubber & air1</i> ($d = 0.78$); <i>gel2 & air1</i> ($d = 0.55$);
X-all	0.042	1	<i>fabric & gel5</i> ($d = 1.01$)

Grip force = 50 N

ECR	0.000	10	<i>fabric & air2 (d = 0.87); fabric & hybrid (d = 0.82); fabric & gel3 (d = 0.83); fabric & gel5 (d = 1.13); fabric & air1 (d = 1.36); rubber & gel5 (d = 1.08); rubber & air1 (d = 1.35); gel4 & air1 (d = 1.00); gel2 & air1 (d = 0.85); gel1 & air1 (d = 0.72)</i>
ED	0.83	/	
FCR	0.000	10	<i>fabric & gel4 (d = 1.06); fabric & air2 (d = 0.88); fabric & gel1 (d = 1.21); fabric & hybrid (d = 1.03); fabric & gel3 (d = 1.06); fabric & gel5 (d = 1.19); fabric & air1 (d = 1.73); rubber & air1 (d = 1.01); gel2 & air1 (d = 0.79); air2 & air1 (d = 0.99);</i>
FDS	0.65	/	
ECR- FCR	0,000	15	<i>fabric & gel4 (d = 1.27); fabric & gel2 (d = 0.97); fabric & air2 (d = 1.15); fabric & gel1 (d = 1.08); fabric & hybrid (d = 1.12); fabric & gel3 (d = 1.20); fabric & gel5 (d = 1.61); fabric & air1 (d = 2.04); rubber & gel5 (d = 0.98); rubber & air1 (d = 1.46); air1 & gel4 (d = 1.40); air1 & gel2 (d = 1.14); air1 & air2 (d = 1.16); air1 & gel1 (d = 0.96); air1 & gel3 (d = 0.86);</i>
X-all	0.000	3	<i>fabric & gel4 (d = 0.87); fabric & air2 (d = 0.85); fabric & gel1 (d = 1.04);</i>

5.3.2 Construct validity of the surface EMG methodology

The mean values of the ECR and FCR muscles (ECR_FCR) under 50 N grip force were used to further explore the correlations with the glove properties, namely, thickness, stiffness and dexterity scores (Table 5.2). The results showed a significant correlation ($r = 0.74$; $p = 0.014$) between the normalized ECR_FCR muscles' activities and the glove thickness, as illustrated in Figure 5.4(a). A stronger correlation ($r = 0.90$; $p < 0.001$) was observed between the normalized ECR_FCR muscles' activities and the dexterity scores of the gloves, as shown in Figure 5 4(b). However, there was a non-significant correlation ($r = -0.33$; $p = 0.356$) between the normalized ECR_FCR muscles' activities and the glove material stiffness.

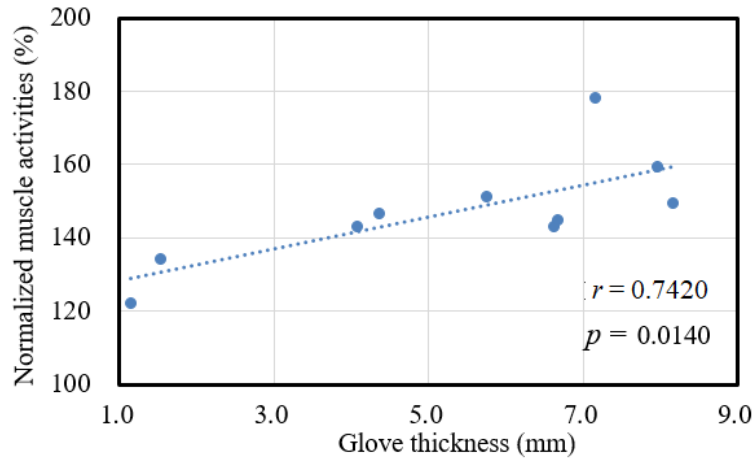

(a)

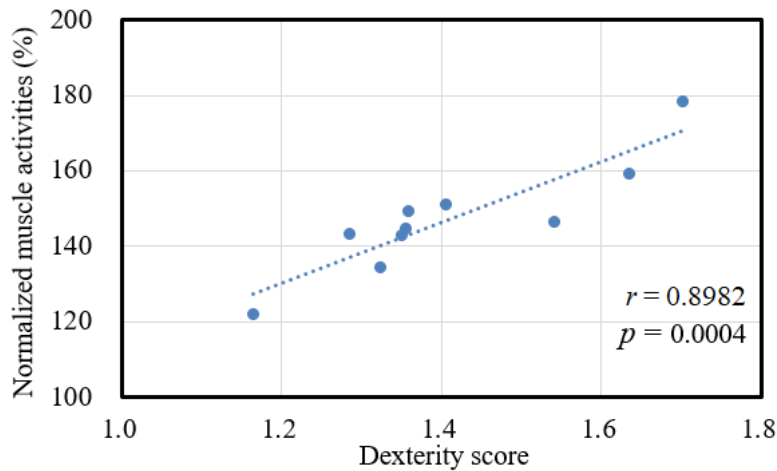

(b)

Figure 5. 4: Correlation coefficient (r) between the normalized activities of ECR_FCR muscles and: (a) glove material thickness; (b) dexterity score.

5.4 Discussions

The aim of this study was to further develop a surface EMG methodology to assess the effect of anti-vibration (AV) gloves on forearm muscles' activities. The findings showed that the largest number (16) of significant differences between the gloves were detected by considering combined ECR_FCR activities and two levels of grip force. The number of significant differences for 50 N grip ($N=38$) was also higher compared to those for the 25 N grip ($N= 22$). The measurement of ECR_FCR muscles' activities with 50 N grip can thus be considered as the most sensitive strategy for investigating the effect of an AV glove on the muscle activation. Correlational analyses with

dexterity tests and glove thickness also supported the construct validity of this EMG-based methodology.

5.4.1 Sensitivity of the surface EMG methodology to AV gloves

The present findings are clear with respect to the most sensitive measurement strategy to AV gloves, namely, combining an effort of 50 N and the average of the scores of the two most sensitive muscles to the glove effect (ECR and FCR). These results are consistent with our previous studies because the ECR was the most sensitive in the first study [18] while it was the FCR in the second [115]. This can be explained by two factors increasing the reliability of EMG measurements and, consequently, their sensitivity to differences between gloves, as discussed next.

A gripping force of 25 or 50 N represents approximately 5 to 20% of the maximum gripping force in a sample of male and female subjects [169]. Such small efforts have the advantage of not fatiguing muscles and thus of carrying out several tests/gloves during the same session. On the other hand, this leaves a lot of room for the central nervous system to perform the task in different ways [170, 171]. It allows the different fingers/muscles to contribute to the collective effort in a variable way to achieve the prescribed force, which leads to intra- and inter-subject variability and consequently, decreases reliability and sensitivity respectively. This phenomenon, called "variable load-sharing", is more likely to occur at lower force levels [172, 173]. It is possible that the efforts at 50N have reduced the influence of this phenomenon or, in other words, reduced the variability of muscle activation, as suggested by the lower standard deviations at 50 N than at 25 N for a given muscle (Figure 5.3). Consequently, it may be advantageous to increase the force (e.g. 80 N) to do even better, but at the expense of increasing muscle fatigue with repeated contractions. An additional explanation for the higher sensitivity of the ECR_FCR_50 N strategy would come from the fact that averaging the EMG activation of muscles having the same function in a given task increases the reliability of the average score [174, 175].

5.4.2 Construct validity of the surface EMG methodology

A significant correlation ($r = 0.74$) between glove thickness and the normalized muscle activities of the ECR_FCR_50 N was observed, suggesting that the use of thicker gloves lead to higher muscle activation. These results are in line with previous studies showing decreased grip strength with the use of thicker gloves [96, 100, 102].

As expected from previous findings relating the detrimental effect of glove stiffness on manual dexterity [2, 97, 98], normalized muscle activities (ECR_FCR at 50 N), were correlated

with manual dexterity score ($r = 0.90$). Recall that muscle activities, as measured in the present measurement protocol, is like an indirect measure of grip strength or glove stiffness (see introduction). Thicker gloves have also been reported to result in poorer dexterity [2, 15]. The results suggested glove thickness is one of the major factors that influence muscle activities and dexterity. Higher muscles' effort is to be expected because of glove's hindrance to the task. In this study, a non-significant correlation ($r = -0.33$) was observed between the glove material stiffness and muscle activities (ECR_FCR at 50 N. It suggested that glove material may influence the force output due to the elasticity of the material. Some reduction in force transmission may be caused by friction between the glove and the gripping surface [172]. Larivière et al. [115] reported much higher correlations (0.77 – 0.94) between glove stiffness and grip strength. However, their methodology assessed the overall stiffness of industrial gloves in terms of in-plane stretching as characterized by the free-deforming multidirectional test or the Kawabata Evaluation System for Fabrics [176]. These methodologies did not represent the compression mode stiffness of the anti-vibration glove material, as used in the present study.

5.4.3 Effect of AV gloves on forearm muscles' activities

The results showed that all the gloves invariably increase muscle activities compared to the bare hand. Reported studies have shown that wearing gloves imposes higher muscular efforts to achieve a desired grip effort, when compared to bare-handed trials [15, 18, 96, 115]. The reported studies, however, focused on protective gloves alone. The AV gloves revealed substantially higher muscle activation compared to the industrial (*fabric*) glove considering identical grip effort. This is attributable to relatively thick vibration isolation materials used in AV gloves, which lead to their bulky design. Undeformed thickness of the AV gloves used in this study ranged from about 4 to 8 mm, while the thickness of the *fabric* glove was only 1.2 mm. The *rubber* glove (thickness ≈ 1.5 mm) formed an exception. Although the *rubber* glove is specified as an AV glove by the manufacturer, its vibration isolation performance is inferior to those of the other AV gloves [3]. The *fabric* and *rubber* gloves with the lowest thickness showed the lowest increase in muscle activities, ranging from 21% to 28% and 32% to 35%, respectively, irrespective of the grip force. Hamouda et al. [3] reported 16% reduction in the grip strength with the usage of a thin leather glove.

Highest increases in total normalized muscles' activities were observed with *air1* (53-61%) and *gel5* (50-57%) gloves, likely due to their higher thickness (7.2 mm and 8.0 mm, respectively). These two gloves, however, satisfy the vibration attenuation screening criteria defined in ISO 10819

[11], as reported in chapter 4. The rest of the AV gloves, made of gel or combination of gel and air bubble materials, showed somewhat comparable increase in the total normalized muscles' activities (36-49%), irrespective of the grip force considered. Hamouda et al. [3] also reported comparable grip strength reductions (28-32%) for the gel, hybrid and gel-foam groups of AV gloves, when applying MVC efforts. Similarly, Wimer et al. [100] obtained 35% reduction in hand grip strength with a gel glove during MVC exertions. These gloves also showed comparable thickness in the range of 4.1-6.7 mm, except for the *gel3* glove (8.2 mm thick), as shown in Table 5.2. Though *gel3* glove has the largest thickness, the muscle activities were comparable to the relatively thinner gloves. It is thus deduced that the increase in the muscle activities could not be only established from glove thickness. Other factors such as friction, fitness, texture of the covering material may also play an important role in muscles' activities. It has been suggested that the flexibility and surface friction of the glove material may reduce the force transmission between the glove and the gripping surface [172].

Apart from the above-stated glove design factors, greater grip effort demand and thus increased muscles activation is partly due to deformation of the vibration isolation material by the user. Wimer et al. [100] reported that a portion of the hand grip effort is absorbed by the vibration absorption materials of the AV glove. The muscles' activation is directly related to the grip force magnitude.

5.5 Conclusions

Anti-vibration gloves cause substantially higher forearm muscles activities during a handgrip task compared to bare hand, irrespective of the muscle type and grip force. The ECR and FCR muscles are more sensitive than the ED and FDS muscles for quantifying the biomechanical effects of gloves on forearm muscles internal loading. The measurement of combined ECR and FCR muscles activities with 50 N grip is found to be the best strategy for investigating the effect of an AV glove on the muscle's activation. Activities of the ECR_FCR muscles was correlated with glove thickness ($r = 0.74$) and strongly correlated with glove dexterity ($r = 0.90$). It proved the construct validity of the normalized ECR_FCR muscle activities with regards to manual dexterity. A non-significant correlation ($r = -0.33$) was observed between the glove stiffness and the muscle activities of the ECR_FCR.

CHAPTER 6: A METHODOLOGY FOR INTEGRATED PERFORMANCE ANALYSES OF ANTI-VIBRATION GLOVES

6.1 Introduction

AV gloves with relatively thick vibration isolation materials help limit the palm vibration transmissibility and thereby may satisfy the screening criterion of ISO 10819 [11]. Thick AV gloves, however, adversely affect both the grip strength and manual dexterity of the operator [2, 3]. The operators may thus be reluctant to use such gloves while working with vibrating tools, especially in conjunction with other manual tasks, even though the gloves yield beneficial effect in limiting exposure to HTV. Enhancing the grip strength and dexterity performance of AV gloves apart from the attenuation of palm- and fingers'-transmitted vibration can help promote their usage in the workplace. The current assessment method, however, is based solely on the palm-transmitted vibration. Although, some notable efforts have been made towards establishing methods for investigating each of the aforementioned four factors independently, namely, palm and fingers' vibration attenuation, manual dexterity and grip strength, no attempt has been made to develop a methodology to evaluate the integrated performance of AV gloves. Development of a methodology that permits consideration of the conflicting measures simultaneously can provide essential design guidance for AV gloves for realizing improved palm- and fingers' vibration attenuation, while preserving the grip strength and manual dexterity performance.

Considering the multiple performance measures and their conflicting design requirements, multiple criteria decision making (MCDM) methods may be employed to identify gloves with enhanced integrated performance [177]. MCDM methods are widely used in the field of operations research to achieve solutions for problems involving multiple alternatives together with multiple conflicting performance criteria. Analytical hierarchy process (AHP) proposed by Saaty [178] is one of the most extensively used MCDM methods, and it has been applied to a wide variety of decision making and human judgement processes. The AHP is based on the well-defined mathematical structure of consistent matrices and their associated right-eigenvectors for identifying approximate weights for individual performance measures, which are used to rank various alternatives and facilitate decision making [179].

This study proposes a methodology for assessing the integrated performance of AV gloves considering manual dexterity, vibration transmissibility at palm (TR_palm) and fingers (TR_fingers)

and muscles' activity. The relative importance of individual performance measures was judged for these different work conditions to formulate pairwise comparison matrices. The weights of individual measures were identified, and an integrated performance index is developed as the sum of weighted individual measures for ranking the gloves based on defined work conditions. The proposed index could help to prioritize (rank) the gloves and to make more accurate decisions for selection of gloves.

6.2 Identification of weights of individual measures using analytical hierarchy process

6.2.1 Methodology

Owing to conflicting design requirements of individual performance measures of AV gloves, multiple criteria decision-making methodology (MCDM) based on analytical hierarchy process (AHP) is considered for identification of a near optimal AV glove, considering the multiple conflicting criteria and multiple possible alternatives. The AHP adopts pair-wise comparisons to formulate a judgement to determine relative weights for the individual measures. This method also employs the consistency check to screen out inconsistencies that may arise from inappropriate judgements [180]. The AHP involves three basic steps: decomposition leading to construction of a hierarchy structure; comparative judgments to obtain pairwise comparison data on elements of the hierarchical structure; and synthesis of priorities and evaluation of an overall priority rating [181].

The AHP, in the first stage, formulates a MCDM problem into a hierarchy of all essential elements that often comprises a three-level structure describing, from top to bottom, the goal, the criteria, and alternative levels, respectively. In this study, a hierarchical structure is constructed for selecting a near optimal AV glove considering the work conditions and given alternatives, as shown in Figure 6.1. The performance measures of the AV glove, namely, the manual dexterity, vibration transmissibility at palm and fingers, and grip strength constitute the criteria level. The grip strength performance measure of the glove is expressed in terms of the normalized activity of the combined flexor carpi radialis (FCR) and extensor carpi radialis longus (ECR), as reported in [182]. The figure shows five different AV gloves, considering in the study, as the alternatives in the bottom level. These include: two gloves with air bladder vibration isolation material, denoted as *air1* and *air2*; two gloves employing different gel materials, denoted as *gel2* and *gel5*; and a glove design with air bladder and gel materials in the palm- and fingers'-regions, respectively, denoted as *hybrid*. The selected gloves were judged to satisfy the vibration attenuation screening criteria defined in ISO-

10819 [11], as reported in Yao et al. [183] together with the construction of the gloves, and equivalent stiffness and damping properties of the vibration isolation materials.

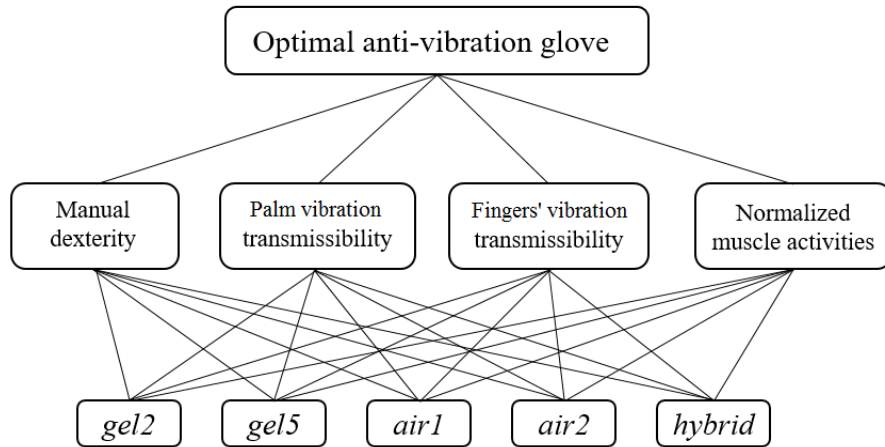

Figure 6. 1: A hierarchical structure for identifying a near optimal alternative

A pairwise comparison matrix (PCM) is subsequently constructed through comparisons of different combinations of two elements in the criteria level of the hierarchy with respect to an element in the higher level of the hierarchy (goal). For n comparative elements, the decision-making process is based on $n(n-1)/2$ comparison pairs. The pairwise comparisons at the criteria level can be presented as a square matrix A [184], as follows:

$$A = [a_{ij}]_{n \times n} = \begin{bmatrix} a_{11} & a_{12} & \dots & a_{1n} \\ a_{21} & a_{22} & \dots & a_{2n} \\ \vdots & \vdots & \ddots & \vdots \\ a_{n1} & a_{n2} & \dots & a_{nn} \end{bmatrix} \quad (6.1)$$

The above PCM possesses reciprocal property, such that:

$$a_{ji} = \frac{1}{a_{ij}} \quad (6.2)$$

The relative importance of any two elements in making the pairwise comparison is described by a scale, ranging from 1 to 9, as recommended by Saaty [178]. The higher score of an element in a pairwise comparison denotes relatively higher importance, which is generally assigned by the decision maker considering the operating/task conditions and the guideline in Table 6.1. For comparison of elements i and j , a scale of 9 describes extreme importance of element i over element j . The element j is assigned a reciprocal value ($1/9$) when compared with i . Since an element is equally important when compared with itself, the diagonal elements of the PCM must consist of unity values. Considering the law of reciprocity of the PCM, the pairwise comparisons require relative importance scores only in the upper triangular matrix [185]. The formulation of the PCM for a decision-making problem is known to be challenging in the presence of uncertainties in the

elements of the hierarchy level. In such a situation, the PCM is generally formulated on the basis of the decision maker's experience and knowledge [186].

Table 6. 1: The 1-9 point scale used for pairwise comparisons of the elements in an AHP [199].

Relative importance of one over another	Importance on an absolute scale
Equal importance	1
Moderate importance	3
Essential or strong importance	5
Very strong importance	7
Extreme importance	9
Intermediate values between the two adjacent judgments of importance	2,4,6,8

The consistency of judgments in the PCM is evaluated on the basis of the principal eigenvector, $\omega^* = (\omega_1, \omega_2 \dots \omega_n)$, corresponding to the highest eigenvalue λ_{max} , which can be estimated from [178]:

$$\omega_i = \frac{\sum_{j=1}^n a_{ij}^*}{n}; i= 1,2,\dots,n \quad (6.3)$$

where

$$a_{ij}^* = \frac{a_{ij}}{\sum_{i=1}^n a_{ij}}; j= 1,2,\dots,n \quad (6.4)$$

In the above formulation, $\omega_i > 0$ and $\sum_{i=1}^n \omega_i = 1$ [178]. The consistency of the elements of the PCM is subsequently evaluated from the consistency ratio (CR), defined as the ratio of the consistency index (CI) to the random index (RI). The consistency index is estimated from the principal eigenvalue, as:

$$CI = \frac{\lambda_{max} - n}{n - 1} \quad (6.5)$$

It has been reported that a judgment is more consistent when λ_{max} is close to n . The value of RI , however, depends on the dimension of the PCM and it relates to mean value of CI . Saaty [178] generated random values for different dimensions of the PCM with the sample size of 500 and obtained the means of the corresponding CI values. For $n=4$, considered in this study, a RI value of 0.9 has been recommended. The consistency ratio (CR) of the PCM with four criteria is thus obtained as:

$$CR = \frac{\lambda_{max} - n}{0.9(n - 1)} \quad (6.6)$$

A PCM is considered to possess an acceptable consistency, when $CR < 0.10$. The pairwise comparison scales in the PCM thus need to be revised if CR exceeds 0.1. The priorities or relative weights of each element in the criteria level are finally obtained from the principle eigenvector.

The MCDM problem is initially formulated to identify near optimal AV gloves considering the standardized vibration spectrum defined in ISO 10819 [11] for evaluating vibration performance of AV gloves. The problem is subsequently formulated considering three different work conditions involving two different classes of vibration spectrum predominant in the low (< 200 Hz) and high (200 Hz to 1250 Hz) frequency ranges, and assembly/disassembly tasks in conjunction with low frequency vibration spectrum. These are described in the following sections. It should be noted that the individual performances of the gloves in the alternatives level of the hierarchy are considered to be known. The relative judgements and the solutions are thus limited only to the criteria level.

6.2.2 Formulations of pairwise comparison matrix

Rakheja et al. [80] proposed a methodology to identify tool-specific AV gloves on the basis of vibration spectra of different tools apart from the dynamic properties of the glove materials. The study also compared vibration spectra of selected tools with the standardized spectra, as shown in Fig. 6.2. The vibration due to the road breaker and nutrunner predominate in the lower frequency range (12.5-31.5 Hz). Although the selected tools exhibit notable vibration in the H-frequency range, the standardized spectrum shows relatively higher magnitudes of high frequency vibration. While the predominant frequencies of vibration of the random orbital sander could be considered to lie within the range of the M-spectrum, the corresponding magnitudes are considerably higher (Fig. 6.2). Tools such as chipping hammers, pneumatic grinders and metal drills exhibit dominant vibration in the relatively higher frequency ranges [165]. Although the magnitudes of vibration spectra of different tools differ considerably from the standardized vibration spectrum, different tools may be grouped by two dominant frequency ranges of specified in ISO 10819 [11], namely, 25-200 Hz and 200-1250 Hz ranges. The PCMs are formulated for two classes of tool handle vibration: high frequency (e.g., impact drills and chipping hammers) and low frequency (e.g., road breakers and nutrunners), whose vibration characteristics are idealized by the standardized vibration spectrum in the medium (M: 25-200 Hz) and high (H: 200-1250 Hz) frequency ranges [11]. Moreover, the PCM is also formulated for the assembly/disassembly task in conjunction with lower frequency vibration spectrum.

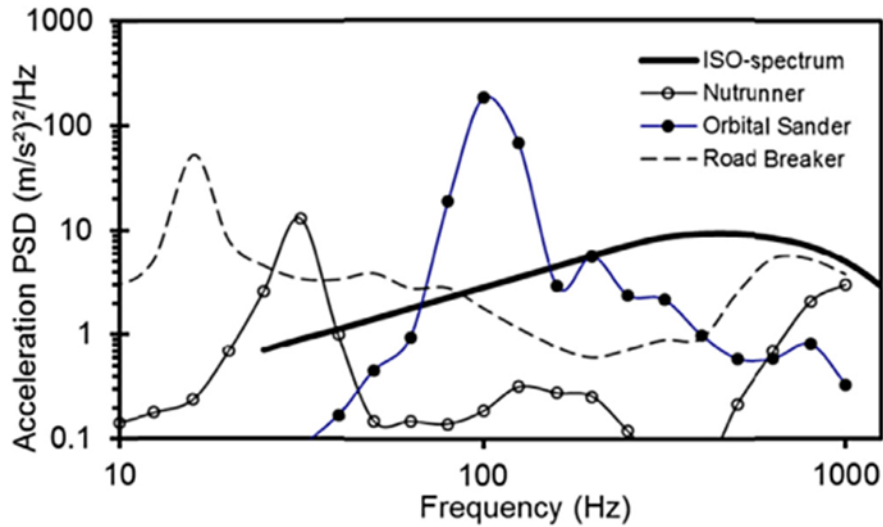

Figure 6. 2: Acceleration power spectral density (PSD) of the standardized [11] and considered tools' vibration [80].

Owing to large differences in frequency ranges of predominant vibration of different tools, the PCMs are formulated for two classes of tool handle vibration: high frequency (e.g., impact drills) and low frequency (e.g., road breakers and nutrunners), which can also be characterized by the standardized vibration spectrum in the medium (M: 25-200 Hz) and high (H: 200-1250 Hz) frequency ranges [11]. Moreover, the PCM is also formulated for the assembly/disassembly task in conjunction with lower frequency vibration spectrum.

Pairwise comparison matrix – High frequency vibration spectrum

The effectiveness of an AV glove in reducing the vibration hazard is dependent on the characteristic of the tool handle vibration and the extent to which different vibration frequencies cause injury in the hand. The fingers vibration transmissibility characteristics generally exhibit resonant peaks in the 80-200 Hz frequency range depending on the type of AV glove or vibration isolation material [5, 6]. The standardized vibration spectrum exhibits peak vibration level (acceleration power spectral density (PSD)) near the 315 Hz band, which is somewhat close to the observed resonant frequency of the middle finger (around 225 Hz), as reported in Hamouda et al. [3]. The biodynamic responses of the hand-arm system have also suggested substantially higher resonant frequencies of the fingers compared to the palm and the hand-arm structure [79, 161]. It may thus be deduced that the handle vibration represented by the standardized high frequency vibration spectrum would yield most important influence on the fingers' vibration transmissibility (TR_fingers) compared to the other measures. The normalized muscles activity, a measure of operator fatigue, may also be taken

as relatively more important, since guiding/maneuvering of such tools can impose considerably higher demand on forearm muscles. It has been reported that the muscle activities increase with the increased hand grip effort [187]. Although the palm vibration transmissibility (TR_palm) generally exhibits amplification of handle vibration in the low frequency range, 20-30 Hz, [4, 109]. It constitutes an important factor since the current screening criteria for AV gloves is based on this measure. The manual dexterity that affects the task completion time, apart from operator’s comfort and work precision, may be considered as least important.

The TR_fingers is thus considered to be of highest importance (scale: 9) for selection of an AV glove for isolating the high-frequency vibration spectrum, compared to the manual dexterity, which is taken as the least important (scale: 1). The normalized muscles activity (scale: 8) is considered to be of strong importance than the manual dexterity, but comparable or slightly less important than TR_fingers (scale: 2). The TR_palm is considered to be very strongly important (scale: 7) than the manual dexterity, while it is assigned an essential importance (scale: 1/4) and slightly lower importance (scale: 1/2) compared to that of the TR_fingers and muscles activity, respectively. Table 6.2 presents the upper triangle of the pairwise comparison matrix for the high frequency vibration spectrum. The lower triangular of pairwise comparison matrix are obtained from the corresponding reciprocal values.

Table 6. 2: Pairwise comparison matrix for tools with dominant vibration in the higher frequency range

Elements	TR_palm	TR_fingers	Muscles activity	Manual dexterity
TR_palm	1	1/4	1/2	7
TR_fingers		1	2	9
Muscles activity			1	8
Manual dexterity				1

Pairwise comparison matrix – Low frequency vibration spectrum

As stated above, the palm vibration transmissibility characteristics generally exhibits amplification of handle vibration in the low frequency range, 20-30 Hz, [4, 109]. The handle vibration represented by the standardized spectrum in the lower frequency range is thus expected to yield most important influence on the palm vibration transmissibility (TR_palm), followed by TR_fingers, since the resonance frequency of index finger lies within this frequency range (≈ 125 Hz). Although the

normalized muscles activity is relatively less important than the palm and fingers vibration characteristics, it is considered to be relatively more important than the manual dexterity, which affects the task completion time, apart from operator’s comfort and work precision.

The TR_palm (scale: 9) was considered to be of highest importance with respect to manual dexterity for low frequency tools considering the amplification of handle vibration transmitted to the palm through majority of the gloves in the 20-30 Hz frequency range [5]. The fundamental natural frequency of the index and middle fingers, however, lie in the vicinity of 125 Hz and 225 Hz, respectively. Compared to the manual dexterity, a scale of 7 is assigned for TR_fingers considering the resonances of the middle and index fingers near 125 Hz and 225 Hz, respectively. TR_fingers, however, is considered to be relatively less important than the TR_palm. The relative importance of the muscle’s activity, assigned a scale of 5, is considered to lower than that of TR_palm but greater than that of the manual dexterity. Compared to the TR_fingers, the TR_palm is of relatively higher important, which is assigned a scale of 2, while the importance of the muscle’s activity is slightly less importance with a scale of 1/2. The importance of TR_palm is thus assigned a scale of 4, compared to that of muscles activity. Table 6.3 showed the resulting PCM for selection of gloves under lower frequency vibration.

Table 6. 3: Pairwise comparison matrix for tools with dominant vibration in the lower frequency range

Elements	TR_palm	TR_fingers	Muscles activity	Manual dexterity
TR_palm	1	3	5	9
TR_fingers		1	3	7
Muscles activity			1	5
Manual dexterity				1

Pairwise comparison matrix – Manual tasks and low frequency vibration spectrum

In many work situations, the workers are required to perform manual assembly/disassembly tasks apart from operating power tools. AV gloves with improved dexterity, muscles strength and vibration isolation would encourage continued usage of AV gloves while switching between tasks. In such situations, the manual dexterity and grip strength form the most important criteria compared to the vibration isolation performance. The manual dexterity is thus assigned the highest importance (scale: 9) followed by the muscles’ activity (scale: 8). The relative importance of manual dexterity

compared to that of the muscles' activity is assigned a scale of 2. It suggests nearly equal importance between the manual dexterity and the muscles activity when performing multiple tasks. Although the vibration isolation may be less important due to relatively lower exposure duration compared to the ergonomic performance with manual tasks, the TR_palm (scale: 5) is considered with relatively higher importance than the TR_fingers (scale: 3). The manual dexterity is assigned a very strong importance (scale: 5), compared to that of the TR_palm, while a similar scale (4) is assigned to represent the relative importance of muscles activity to that of the TR_palm. The relative higher importance of muscles activity is also assigned with a scale of 6, compared to that of TR_fingers. The resulting PCM describing judgments for the multiple tasks are shown in Table 6.4.

Table 6. 4: Pairwise comparison matrix when operators are required to perform assembly/disassembly tasks in addition to low frequency tools

Elements	TR_palm	TR_fingers	Muscles activity	Manual dexterity
TR_palm	1	3	1/4	1/5
TR_fingers		1	1/6	1/7
Muscles activity			1	1/2
Manual dexterity				1

6.2.3 Data collection

This section describes the collection of relevant data for evaluating integrated performance of AV gloves in the framework of the MCDM method. The relevant data include manual dexterity, TR_fingers, TR_palm and muscle activities, in Table 6.5. The manual dexterity scores of the gloves, chosen as alternatives in the current study, were obtained with 15 male subjects using the ASTM F2010 standard and two-hand turning and placing Minnesota tests, as described in [2]. The dexterity score of a glove was defined as the task completion time by the gloved hands normalized with respect to that obtained from the bare-handed measurements. Since the two test methods did not show significant difference on manual dexterity of the gloves ($p>0.05$), the dexterity scores obtained from the Minnesota test are considered in this study.

The TR_palm and TR_fingers measures of the same gloves were obtained using the standardized palm adapter and Velcro finger adapters, respectively, with three-axis accelerometers, as described in [3]. The measurements were performed with 15 subjects. The subjects grasped the instrumented handle with 30 ± 5 N grip and 50 ± 8 N push force with the bare hand or wearing an AV glove, while maintaining the posture in accordance with ISO 10819 [11]. The handle was

subjected to broad-band random vibration spectrum, defined in ISO 10819 [11], when the grip and push forces imposed by the subject approached steady values. The signals from the handle, palm and fingers' accelerometers were acquired in a multi-channel data acquisition and analysis system for the duration of 30s. Although the index and middle fingers vibration responses have been measured, for simplicity, only the middle finger vibration transmissibility is used in this study to represent all the fingers since there is no significant difference between the index and middle finger vibration transmissibility in the H- frequency range ($p = 0.07$). The w_h -weighted TR_palm in the M- and H-frequency ranges, and w_p -weighted TR_fingers measures of the five gloves considered in this study were evaluated as reported in [183] and summarized in Table 6.5.

The stiffness and damping properties of the glove materials were also estimated by measuring force-deflection and force-velocity characteristics of each glove material under uni-axial compression/tension loading. Each material was placed on the platform of an electro-hydraulic vibration exciter and was preloaded to 140 N through a rigid load indenter by displacing the hydraulic actuator statically. The quasi-static stiffness of each material was measured by applying 0.75 mm amplitude harmonic displacement at 0.1 Hz, while the dynamic properties of each material were subsequently measured by applying the same amplitude displacement at 20 Hz and 30 Hz [183]. The force-deflection and force-velocity data acquired for each material were analyzed to estimate static and dynamic stiffness and equivalent viscous damping of each material, which are also summarized in Table 6.5. In addition, the overall undeformed thickness of the glove material between the hand and the contacting surface was measured in the index finger and palm regions using a caliper. All the gloves showed the identical material thickness at the fingers and palm, except for the *hybrid* glove (Table 6.5). The *hybrid* glove comprised relatively thick air-bladder vibration isolation material in the palm and a thinner gel material in the fingers' region.

The hand grip strength corresponding to maximum voluntary contraction (MVC) has been measured directly using the dynamometers or instrumented handles [3, 102, 109] and indirectly from the EMG of the forearm muscles under submaximal grip conditions [18]. The activities of the dominant forearm muscles were measured using EMG, while gripping an instrumented handle with and without the AV glove and two different levels of constant grip force [182]. The measured muscles activities obtained with an AV glove were normalized by that obtained with the bare hand condition. The results showed that the combination of ECR and FCR (ECR_FCR) muscles has the highest sensitivity for discriminating AV gloves in view of their grip strength performance. The

mean values of normalized activity of the ECR_FCR muscles combination of each glove, acquired with 15 subjects and 50 N grip force, were taken in this study for assessing integrated performance of the AV gloves. Table 6.5 summarizes the mean normalized muscles' activity (ECR_FCR) of the five gloves considered.

Table 6. 5: Mean measures of individual performance measures of five gloves considered as possible alternatives together with material thickness, index finger width and equivalent stiffness/damping properties

AV Glove		<i>gel2</i>	<i>gel5</i>	<i>air1</i>	<i>air2</i>	<i>Hybrid-palm</i>	<i>Hybrid-finger</i>
Manual dexterity score		1.35	1.63	1.70	1.35	1.40	
Muscles activity (mean ECR_FCR)		1.43	1.59	1.78	1.45	1.49	
w_h -weighted TR_palm (M-range)		0.82	0.87	0.81	0.79	0.79	-
w_h - weighted TR_palm (H-range)		0.41	0.57	0.51	0.43	0.39	-
w_p - weighted TR_index finger (M-range)		1.01	0.98	0.93	0.91	-	0.91
w_p - weighted TR_index finger (H-range)		0.55	0.79	0.75	0.72	-	0.88
w_p - weighted TR_middle finger (M-range)		0.94	0.88	0.81	0.81	-	0.78
w_p - weighted TR_ middle finger (H-range)		0.50	0.76	0.69	0.80	-	0.78
Glove thickness (mm)		6.8	8.0	7.2	6.7	8.1	5.7
Index finger width (mm)		34.0	34.5	40.3	33.4	-	33.4
Equivalent stiffness (kN/m)	quasi-static	87.3	126.4	89.6	71.6	62.3	284.6
	@20 Hz	102.2	163.5	112.8	89.9	79.4	482.4
	@30 Hz	106.6	170.5	117.7	94.8	84.1	506.6
Equivalent damping (Ns/m)	@20 Hz	1.1	2	1.1	0.9	0.9	5.7
	@30 Hz	0.9	1.5	0.8	0.7	0.6	5.5

6.3 Identification of weights and assessments of integrated performance

The principle eigenvalues (λ_{max}) of the PCMs formulated for the work conditions considered were evaluated for estimating the consistency indices and ratios in accordance with Eqs. (6.5) and (6.6) (Table 6.6). The consistency ratios in all the cases were smaller than 0.1, which verified the judgments in the pairwise comparison matrices. The weights for each measure were subsequently established from the PCMs on the basis of the relative importance (priority) of each measure for

selecting the optimal AV glove for given work condition. Table 6.6 presents consistency test results and the weightings of each measure corresponding to the selected work conditions.

Table 6. 6: Consistency ratio and weights for different measures for the three work conditions

		High frequency vibration	Low frequency vibration	Low frequency vibration and manual tasks
Verification of consistency	λ_{max}	4.123	4.171	4.099
	CI	0.041	0.057	0.033
	CR	0.046	0.063	0.037
	CR<0.1?	Pass	Pass	Pass
Weights	Manual dexterity	0.037	0.040	0.509
	TR_palm	0.170	0.566	0.111
	TR_fingers	0.508	0.267	0.053
	Muscles activity	0.285	0.127	0.327

It can be seen that TR_finger (weight: 0.508) is considered to be the most influential factor for the high frequency vibration spectrum, while the manual dexterity is least important (weight: 0.037). The relatively higher priority of muscles' activity (weight: 0.285) is also observed compared to the TR_palm (weight: 0.170). This suggests that the decision-making strategy emphasizes the vibration isolation performance of a glove at the fingers compared to the other measures, when tool vibration is represented by the high frequency standardized vibration spectrum.

For operations with low frequency vibration spectrum, the TR_palm is of highest priority (weight: 0.566) followed by TR_fingers (weight: 0.267) and the muscles activity (weight: 0.127). The manual dexterity shows negligible weighting (0.04) since it was judged as least important compared to vibration isolation. The contribution of the muscles' activity, however, is notable for assessing the integrated performance of AV gloves. When operator is required to perform multiple tasks including manual assembly/disassembly task in conjunction with low frequency vibration tools, the highest weight (0.567) is observed for the manual dexterity, as expected, followed by muscles activity (weight: 0.327). Negligible weights of the palm and fingers vibration transmissibility were obtained as 0.111 and 0.053, respectively, as shown in Table 6.6.

The identified weights are further used to formulate performance index for assessing integrated performance of the gloves corresponding to specified work condition. The performance indices for the work conditions considered are presented below.

$$I_H = 0.037D + 0.17TR_{palm} + 0.51TR_{fingers} + 0.29MA \quad (6.7)$$

$$I_L = 0.04D + 0.57TR_{palm} + 0.27TR_{fingers} + 0.13MA \quad (6.8)$$

$$I_A = 0.51D + 0.11TR_{\text{palm}} + 0.05TR_{\text{fingers}} + 0.33MA \quad (6.9)$$

where I_H and I_L are integrated performance indices for the handle vibration represented by the high and low standardized frequency vibration spectra, respectively. I_A is the integrated performance index for multiple assembly/disassembly tasks coupled with low frequency vibration spectrum. In the above formulations, D and MA refer to manual dexterity score and normalized muscles activity, respectively.

The proposed indices were applied to rank available alternatives and for identifying most desirable alternative (glove) for each of the defined work condition. Table 6.7 lists ranking of the 5 gloves considered in the study on the basis of the index values for the considered work conditions. It should be noted that low values of the manual dexterity score, normalized muscles' activity and vibration transmissibility imply enhanced performance of AV gloves in view of individual measures. The lowest value of the index thus represents the most desirable glove among the available alternatives. Different work conditions resulted in different rankings of the gloves, as it would be expected. The *gel5* and *air1* gloves show consistently poorest integrated performance with ranking of either 4 or 5, irrespective of the work conditions considered. The *air2* and *hybrid* gloves, on the other hand, suggest nearly same integrated performance for high and low standardized vibration spectrum, which are ranked best among the five alternatives. The *air2* and *gel2* gloves show best integrated performance, when operator is required to perform manual tasks in conjunction with low frequency vibration spectrum, followed by the hybrid glove.

Table 6. 7: Integrated performance indices and ranking of AV gloves for three work conditions

	I_H	ranking	I_L	ranking	I_A	ranking
<i>gel2</i>	1.00	3	0.95	3	1.30	2
<i>gel5</i>	1.06	4	0.99	5	1.49	4
<i>air1</i>	1.07	5	0.97	4	1.58	5
<i>air2</i>	0.95	2	0.90	1	1.29	1
<i>hybrid</i>	0.94	1	0.90	2	1.33	3

6.4 Discussions

This study proposed a methodology for task-dependent ranking of AV gloves on the basis of a weighted performance index of individual measures, namely, palm and fingers vibration isolation, manual dexterity and grip strength. The results demonstrated best integrated performance of *air2* and *hybrid* glove designs under work conditions involving operation of tools with dominant vibration in the low (<200Hz) and high frequency ranges (>200 Hz). This is attributable to two

factors. Firstly, both the gloves showed comparable w_h -weighted palm and w_p -weighted finger vibration transmissibility ratios, dexterity scores and normalized muscle's activities (Table 6.5). Secondly, the stiffness and damping properties of the materials used in the palm region of both the gloves are quite comparable (Table 6.5). It has been reported that the glove material properties are strongly positive correlated with the w_h -weighted palm vibration transmissibility [182, 183]. The materials used in the palm regions of both the gloves revealed lowest and highest stiffness and equivalent damping coefficients, respectively, compared to the other gloves, as seen in Table 6.5. Such material properties are likely the reason for lower TR_palm values of these two gloves. The isolation materials used in the fingers region of the *hybrid* design showed substantially higher stiffness and damping coefficients compared to that used in *air2* glove, while their TR_finger values are mostly comparable. The TR_finger performance thus could not be directly related to the material properties, as in the case of TR_palm.

Both the gloves also consist of identical soft pearl leather in the working surface with comparable thickness at the fingers, and thereby comparable manual dexterity scores, although the contributions of the dexterity scores to the integrated performance indices (I_H and I_L) are very small (weightings: 0.04 and 0.037). The *hybrid* design showed highest thickness at the palm (8.1 mm) compared to the other gloves, which contributed to its lowest stiffness and damping coefficients and thereby improved vibration isolation performance at the palm. The thinnest glove at fingers (*hybrid*: 5.7 mm) resulted in improved manual dexterity.

The manual dexterity score, however, is the most influential factor determining the integrated performance for work condition involving manual tasks apart from operation of low frequency vibration tool. The results suggested highest weighting for the dexterity score followed by that of the muscles activity, while those related to vibration isolation were very small due to considerably lower duration of exposure to hand-transmitted vibration. For this work condition, highest ranking was obtained for *air2* and *gel2* gloves (Table 6.7) due to their lowest dexterity score (1.35) and muscles activity (1.43-1.45).

The *gel2* glove with thickness of 6.8mm showed lowest manual dexterity score and normalize muscles activity among the selected gloves. This glove, however, is only slightly thicker than *air2* glove (6.7 mm), which showed identical dexterity score, but slightly higher muscles activity compared to *gel2* glove. Moreover, the *gel2* glove design included gel material with a polyurethane (PUF) foam layer and covered by a soft stretchy fabric and elasticized back. The fine

design of *gel2* contributed to the best manual dexterity as well as grip strength performance among the gloves considered. Vibration attenuation performance of *gel2* in the lower frequency range (<200 Hz) was comparable with those of the *air* and *hybrid* gloves, while it revealed greatest attenuation of high frequency handle vibration (>200 Hz) transmitted to the palm, index and middle fingers amongst all the gloves considered [3, 183]. It has been reported that the vibration isolation performance of the AV glove is dependent upon its frequency response characteristics, which are influenced by the viscoelastic properties of the isolating materials [80]. Relatively lower dynamic stiffness and damping of *gel2* than those of *air1* and *gel5* gloves, as shown in Table 6.5, likely contributed to its superior high frequency vibration isolation performance.

The *air1* and *gel5* gloves showed the poorest performance, irrespective of the work condition considered. The *air1* and *air2* gloves comprise identical air bubble vibration isolation material but resulted in substantially different integrated performance (Table 6.7), irrespective of the work condition. This is attributable to relatively bulky and thick design of *air1* glove (thickness: 7.2 mm; width: 40.3 mm) with higher material stiffness and damping, compared to the *air2* glove (thickness: 6.7 mm; width: 33.4 mm), as reported in [2, 183]. The width is the seam-to-seam width of the index finger section of the selected AV gloves. Moreover, *air2* glove consists of softer pearl leather in the working surface, while *air1* is designed with relatively stiff cow leather. Same stiff leather is also employed in the hand dorsum of the *air1* glove, while a more flexible nylon fabric is used in *air2* glove, which provided relatively greater flexibility for the fingers and thereby better manual dexterity.

The *gel5* glove, made of two gel layers covered by stiff pigskin leather on the palm as well as hand dorsum, is a relatively thick and stiff design compared to other gloves. This impeded the hand flexibility and thus the manual dexterity (Table 6.5). The highest increase in the normalized ECR_FCR muscles' activity was also observed with *gel5* (59%), as shown in Table 6.5, likely due to its higher thickness (8.0 mm) and stiff design [183]. Previous studies have reported that thicker gloves lead to greater reduction in the grip strength [100, 117]. Although increasing the glove thickness generally leads to lower palm and fingers vibration transmissibility values [8, 183], the relatively high stiffness and damping of the *gel5* glove resulted in poor vibration isolation performance at the palm when compared to the other gloves. Strong and positive correlations of the palm vibration isolation performance with the stiffness and damping properties of the glove material has been reported in a recent study by the author [183]. However, nearly no correlation was

observed between the glove stiffness/damping properties and the fingers' vibration transmissibility in the lower frequency range, although a moderate correlation between the glove properties and the index finger vibration transmissibility was found in the high frequency range. A significant correlation between the normalized ECR_FCR muscles' activity and the glove thickness ($r = 0.74$; $p = 0.014$) has also been reported [182]. An even stronger correlation ($r = 0.90$; $p < 0.001$) was observed between the normalized ECR_FCR muscles' activity and the dexterity scores of AV gloves. These suggest that the factors influencing the manual dexterity performance would also affect the muscles activity and thus grip strength performance.

The results suggest that decreasing the effective glove stiffness by increasing the glove material thickness at the palm could be an effective way to improve the palm vibration isolation performance of AV gloves, while decreasing the thickness at the fingers would contribute to improved dexterity and grip strength. Moreover, vast differences in the resonant frequencies of the palm and fingers of the hand suggest that a glove design with different vibration isolation materials in the fingers and palm regions would be desirable, as in the case of the *hybrid* glove. The results obtained in this study also suggest superior integrated performance of the *hybrid* design. Such a design, however, would not satisfy the screening criteria for AV gloves in the current standard [11], which requires identical vibration-reducing material in the palm and fingers' sections. Moreover, designs of gloves with better fitting and soft covering could help improve dexterity and grip strength performance and thus the integrated performance of AV gloves.

6.5 Conclusions

This study was an attempt to develop a methodology for evaluating integrated performance of AV gloves considering the distributed vibration transmitted to the palm and fingers, manual dexterity and muscles activity. The proposed methodology could be applied to effectively assess the integrated performance of the AV gloves for different work conditions, and thereby help operators for selecting an optimal glove to reduce the health hazards posed by the hand-transmitted vibration. In general, the integrated performance of *air2* and *hybrid* gloves were judged superior, followed by that of the *gel2* glove. The *air1* glove showed the poorest integrated performance, followed by the *gel5*. A glove design with different vibration isolation materials in the fingers and palm regions would be desirable for improved isolation of vibration transmitted to the palm and fingers. Decreasing the effective glove stiffness by increasing glove material thickness at the palm can yield improved palm vibration isolation, while decreasing the thickness at the fingers would contribute

to improved dexterity and grip strength. Further efforts would thus be desirable in realizing hybrid glove designs with different thickness and material properties in the palm and fingers regions to achieve improved integrated performance.

CHAPTER 7: CONCLUSIONS AND RECOMMENDATIONS

7.1 Major contributions and highlights of the dissertation research

This dissertation research presents systematic analytical and experimental studies on the development of an evaluation methodology for the AV gloves performance in terms of distributed vibration isolation, manual dexterity and the grip strength. An index is proposed considering the integrated performance of AV gloves for helping the operator to select near optimal AV glove according to different work conditions. The proposed methodology is expected to help promote the usage of AV gloves for reducing the risks of vibration induced injuries. The major highlights of the dissertation research are summarized below:

- The methods of characterizing the fine and coarse dexterity of AV gloves are identified and the manual dexterity of AV gloves is investigated; and the critical glove design factors are identified.
- A thin flexible low-cost hand sensor is used to study the contact force at the viscoelastic hand-handle interfaces, so as to investigate the effect of AV gloves/materials on the grip strength through direct measurements.
- The correlations among manual dexterity, frequency-weighted vibration transmissibility at palm and fingers, and material properties in terms of equivalent stiffness and equivalent damping and thickness are explored to better understand the influences of these factors on the AV glove integrated performance.
- The effect of AV gloves on forearm muscles' activities is investigated to identify the most sensitive muscles for discriminating gloves and to assess their construct validity with regard to grip strength performance.
- A methodology for evaluating the integrated performance of anti-vibration gloves considering manual dexterity and distributed palm and fingers' vibration transmissibility as well as the muscles' activities is developed to select near optimal AV glove for different work conditions.

7.2 Major conclusions

The major conclusions drawn from the study are summarized below:

- All the gloves impeded dexterity when compared to bare-handed performance. While all the AV gloves revealed higher dexterity scores compared to the conventional glove. The

normalized dexterity scores of AV gloves ranged from 1.14 to 1.73, irrespective of test methods. The manual dexterity decreased nearly linearly with increase in the glove thickness.

- A good correlation ($r = 0.82$) was observed between the two dexterity test methods, ASTM test and Minnesota test, which was statistically significant ($p < 0.01$). However, the Minnesota test showed lower sensitivity than the ASTM test in term of determining the gloves.
- Glove thickness and manual dexterity scores obtained with both the methods showed a good correlation, while there was nearly no correlation between the hand size, length of finger and the manual dexterity. A moderate correlation between the glove thickness and the number of drops was also seen in both the test methods.
- The flexible thin-film sensor measurement system could yield direct measurements of the contact force and its distribution over the viscoelastic hand-handle or hand-glove interface. The application of the sensor to the gloved hand, however, posed considerably challenges and revealed poor repeatability.
- The contact force developed by the bare hand grasping a tool handle enveloped by a viscoelastic vibration absorbing material or the hand grasping a rigid handle via an anti-vibration glove revealed similar linear dependence on both the grip and push forces. The contribution of the grip force to the contact force, however, was 27.5% and 37.9% greater for the viscoelastic interface and gloved hand, respectively, compared to the rigid interface. The push force contribution is also increased by 23.8% and 34.5%, for the viscoelastic interface and gloved hand, respectively, compared to the rigid interface.
- Relatively higher grip strength demand for a gloved hand and hand coupling a viscoelastic handle compared to the bare hand condition for realizing the same level of grip/push force combination.
- The isolation of handle vibration transmitted to the palm is mostly influenced by the mechanical properties and thickness of the material in the palm region; Strong positive correlations were observed between the palm vibration isolation and the material properties and thickness in the entire frequency range. The AV gloves are thus less effective in protecting the fingers from vibration than they are in protecting the palm. AV gloves offer attenuation of fingers' transmitted vibration at frequencies above 400 Hz. Hybrid design of

AV gloves would be desirable for realized improved isolation of vibration transmitted to the palm and fingers.

- Anti-vibration gloves cause substantially higher forearm muscles activities during a handgrip task compared to the bare hand, irrespective of the muscle type and grip force.
- The combined ECR and FCR muscles' activity was judged as the best strategy for investigating the effect of an AV glove on the muscle's activation.
- Combined ECR_FCR muscles' activity showed good positive correlation ($r = 0.74$) with the glove thickness and strong correlation ($r = 0.90$) with the glove dexterity.
- Multiple criteria decision-making approach is better suited for identifying task-specific AV gloves considering conflicting design requirements of different performance measures.
- The integrated performance of the *air2* and *hybrid* gloves were judged superior, while *air1* showed the poorest integrated performance, followed by *gel5*, irrespective of the work conditions, considered in the study.
- It is feasible to design AV gloves with good vibration isolation and manual dexterity as well as grip strength performance.

7.3 Recommendations for future studies

The proposed comprehensive evaluation methodology of AV gloves considering the vibration isolation at palm and fingers, the manual dexterity and forearm muscle activities while gripping the instrumented handle can serve as an effective tool for selecting optimal gloves for operators according to different work conditions. This study represents the first attempt for quantifying manual dexterity and integrated performance of AV gloves. The proposed methodology for selecting near optimal glove is applied for three different work conditions as an example. For more efforts are thus desirable to establish a reliable methodology for assessment of AV gloves leading to the designs of tool-specific AV gloves. Some of the desirable studies are listed below:

- a. The contact force developed by the bare hand grasping a tool handle enveloped by a viscoelastic vibration absorbing material is lower than that obtained with the hand grasping a rigid handle via an anti-vibration glove, which suggests higher grip strength demand for a gloved hand than that for hand coupling a viscoelastic handle for realizing the same level of grip/push force combination. Further efforts are thus needed in investigating the vibration transmission characteristics due to the glove material wrapped around the handle and gloved

hand handle to study the feasibility of replacing AV gloves by vibration isolation materials wrapped handle.

- b. The glove material and thickness showed different effects on the manual dexterity and vibration transmissibility at the palm and the fingers, as presented in chapters 2 and 4. Further efforts on the design of AV gloves using different material properties at the fingers and palm sections would be desirable, in order to improve the integrated performance of the AV gloves. Although it violates the AV glove criteria defined in the current standard, which specifies the use of identical materials in both the sections.
- c. The gel and air bladder materials exhibit highly nonlinear stiffness and damping properties, and strong dependence on the localized deformations. It would be desirable to develop material models to describe their stiffness and damping properties as function of the preload. A simulation model of the AV glove could be subsequently formulated considering the contact force distribution of the gloved hand.
- d. The hand-transmitted vibration and its control have been thoroughly studied, while the biodynamic responses of human hand-arm system need to be further investigated via developing a biomechanical human hand-arm model. The multi-body dynamic methods could be applied for developing the hand-arm system model incorporated middle and index fingers interaction with the vibrating handle.

Appendix: Statistical Analyses

A. Two-factor repeated-measures analysis of variance

Anti-vibration gloves can limit the hand-transmitted vibration but may adversely affect manual dexterity and work precision. The effects of anti-vibration gloves on the manual dexterity were investigated and the important design factors affecting the manual dexterity were identified (Chapter 2). Two-factor repeated-measures analysis of variance (rANOVA) was conducted to evaluate the main effects of glove type, test method, and their interaction effect on manual dexterity. The rANOVA involves that a single dependent variable is measured on more than one occasion on the same subject [188]. A factor is a classification scheme for the observations. Each factor is composed of two or more subgroups (levels) [188]. The same analytical method was used to assess the influence of glove type, grip force and their interaction on the normalized muscle's activities (Chapter 5).

In general case, two factors are assumed as A (p levels) and B (q levels), the number of subjects is n . Three hypotheses were tested by calculating the F statistic for three distinct effects in the rANOVA. Each level of the independent variable needs to be approximately normally distributed, if not, data should be transformed to meet this assumption. The sphericity, which is the repeated measures equivalent of homogeneity of variances, also needs to be tested using Mauchly's test in SPSS. If the assumption of sphericity is violated, a Greenhouse-Geisser correction has to be used [188]. In addition to the assumptions of normality and homogeneity of variances, a further assumption, homogeneity of covariances between repeated assessments is made. It means that the values of the outcome measure have the same variance at each repetition, meanwhile, all correlations between pairs of repeated measurements within the same subject are equal [189]. A randomization procedure could help to achieve homogeneity of covariance for designs in which heterogeneity of covariance is produced because of repeated testing or sequence effects that are not related to the specific assessment or treatment [190, 191]. Procedures for testing these assumptions are given by [188]. It has been indicated that violation of these assumptions produces large F values relative to the appropriate critical value, which results in rejecting the null hypothesis (H_0) more often than should be the case for the stated significant level [192]. The significant level $\alpha = 0.05$. The H_0 states that there is no difference between related population means for the repeated measures ANOVA tests. The alternative hypothesis (H_1) states that the related population means are not equal

(at least one mean is different to another mean). The F value is calculated to test the hypothesis ($\delta_\alpha^2 = 0$) using the formula:

$$F = \frac{MS_a}{MS_{error(between)}} \quad (A.1)$$

where MS_a is the mean sum of squares for between-groups for factor A , and $MS_{error(between)}$ is the mean sum of squares for error for between-groups. The F value is calculated to test the hypothesis ($\delta_\beta^2 = 0$) that using the formula:

$$F = \frac{MS_b}{MS_{error(within)}} \quad (A.2)$$

where MS_b is the mean sum of squares for factor B , and $MS_{error(within)}$ is the mean sum of squares for error for within-groups. The F value is calculated to test the hypothesis $\delta_{\alpha\beta}^2 = 0$ that using the formula:

$$F = \frac{MS_{ab}}{MS_{error(within)}} \quad (A.3)$$

where MS_{ab} is the total mean sum of squares, The mean squares used in the denominators of the above F values represent a pooling of different sources of variation, which are obtained from corresponding sums of squares by dividing by their respective degrees of freedom [188]. The partition of the total variation and the degrees of freedom are presented in Figure A (a) and (b), respectively. The total sum of squares (SS_T) is decomposed orthogonally to obtain F values and corresponding p values for the H_0 concerning main effects and interactions. The within-groups variance is divided into two orthogonal parts. One part is a function of experimental error plus the main effects of subjects within groups ($SS_{subjects}$), i.e., individual difference. The other part is a function of experimental error and $B \times$ subject-within-group interaction (SS_{error}). If the latter interaction is negligible, then the second part of the within-groups variation is a function solely of experimental error [188].

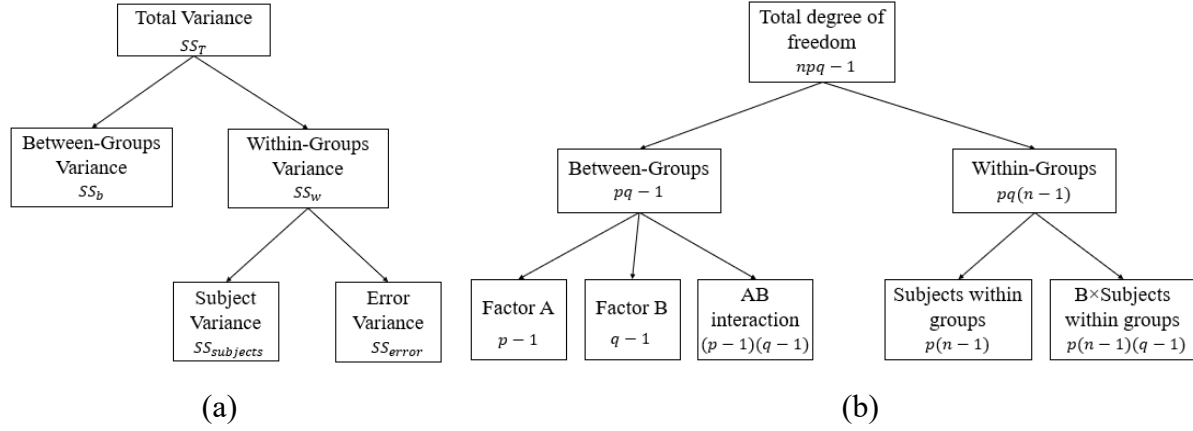

Figure A: Schematic representation of the analysis: (a) Partition of the total variation for repeated measures; (b) Partition of degrees of freedom

$$SS_T = SS_b + SS_w \quad (A.4)$$

where SS_b and SS_w are sums of squares for between-groups and within-groups, respectively.

$$SS_b = \sum_{j=1}^q (\bar{x}_{1j} - \bar{x}_1)^2 + \sum_{j=1}^q (\bar{x}_{2j} - \bar{x}_2)^2 + \dots + \sum_{j=1}^q (\bar{x}_{pj} - \bar{x}_p)^2 \quad (A.5)$$

where \bar{x}_{pj} is the mean of group p with condition j , and \bar{x}_p is the mean of all the conditions in group p .

$$SS_w = SS_{subjects} + SS_{error} \quad (A.6)$$

$$SS_w = \sum_1 (x_{i11} - \bar{x}_{i1})^2 + \sum_2 (x_{i21} - \bar{x}_{i2})^2 + \dots + \sum_q (x_{iqn} - \bar{x}_{iq})^2 \quad (A.7)$$

where x_{iqn} is the dependent value of group i with condition q for subject n , \bar{x}_{iq} is the mean value of group i with condition q for all the subjects. Thus, x_{i11} is the dependent value of group i with condition 1 for subject 1, \bar{x}_{i1} is the mean value of group i with condition 1 for all the subjects.

$$SS_{error} = SS_w - SS_{subjects} \quad (A.8)$$

$$SS_{subjects} = n \sum (\bar{x}_{ik} - \bar{G})^2 \quad (A.9)$$

where \bar{x}_{ik} is the mean of subject k for the group i . n is the number of subjects. \bar{G} is the grand mean.

If the obtained F values larger than the critical values, reject the H_0 and accept the alternative hypothesis. The conclusion drawn is that the means are not all equal. In order to better understand which of the means might be different from which of the others, a post hoc test would be conducted to evaluate which of the means are significantly different from one another. One of the very common approaches is Bonferroni test. The strength of Bonferroni test is to considerably control the Type I errors (rejecting null hypotheses when they are true) rates at or below a nominal value, it is often criticized for being too conservative [193]. The Bonferroni correction is used to limit the

possibility of getting a statistically significant result when testing multiple hypotheses, which is the alpha level divided by the number of tests required to run. The null hypothesis would be rejected if p -value is smaller than the Bonferroni correction. Bonferroni was used in the chapter 2 to identify the difference between any two gloves by pairwise comparison.

The Tukey test, often known as the Studentized range test or the Tukey HSD (honestly significant difference) test, is one of the more conservative simple post hoc tests that exerts considerable control over the experiment-wide error rate. It is designed to make all pairwise or simple comparisons while maintaining the experiment error at the pre-established α level [194]. The null hypothesis tested for each pairwise comparison is $X_c = X_d$ for $c \neq d$, which means each pair of population means is equal. The main idea of the HSD is to compute the honestly significant difference between two means using a statistical distribution defined by Student. The distribution of the Studentized range statistic (Q) is defined as:

$$Q = \frac{\bar{X}_{max} - \bar{X}_{min}}{\sqrt{MSE/S}} \quad (A.10)$$

where \bar{X}_{max} and the \bar{X}_{min} are the largest and smallest means in a set of means. MSE is the mean square error, and S is the group size. The Tukey HSD test uses the studentized range distribution to maintain the experiment error at a given α level. The Q distributions gives the exact sampling distribution of the largest difference between a set of means originating from the same population. When there is an equal number of observations per group,

$$HSD = q_{A,\alpha} \sqrt{\frac{MSE}{S}} \quad (A.11)$$

where $q_{A,\alpha}$ is the value of the q statistics for factor A at α level. If the absolute value of the difference between the means is larger than the HSD value, the comparison is declared significant at the chosen α level. This procedure is repeated for all the comparisons. The Tukey HSD test was applied to the chapter 5 to distinguish the influence of AV gloves on the muscle activities under constant grip force levels.

The statistical power of a study depends on three variables: the level at which the alpha significance is set, the sample size, and the effect size. An effect size measure is a quantity that measures the sizes of an effect as it exists in the population. Descriptive measures of effect size, other than the means themselves, can generally be divided into two types, those that describe differences in means relative to the study's variability and those that look at how much of the variability can be attributed to the treatment conditions [195]. Effect sizes are calculated with the

most common measure being Cohen's d statistic. Cohen's d is defined as the difference between two means divided by a standard deviation for the data,

$$d = \frac{\bar{x}_1 - \bar{x}_2}{SD} = \frac{\mu_1 - \mu_2}{SD} \quad (\text{A.12})$$

where SD , the pooled standard deviation, is defined as (for two independent samples with equal sample sizes):

$$SD = \sqrt{\frac{s_1^2 + s_2^2}{2}} \quad (\text{A.13})$$

s_1 is the variance for one of the groups and similar for the other group. The sums of the squares are measures of variability of the scores, so we can express the effect size in words as

$$\text{effect size} = \frac{\text{variability explained}}{\text{total variability}} = \frac{\text{total variability} - \text{unexpected variability}}{\text{total variability}} \quad (\text{A.14})$$

This expression is easily adapted to all kinds of treatment effects, including those in complex experimental designs and those based on procedures other than the analysis of variance [195]. The effect size can be interpreted following the standards defined by Cohen: 1) a small effect is one that captures about 1% of variance. These effects tend not to be noticed except by statistical mean. In terms of the standardized difference, a small effect has $d \approx 0.25$; 2) A medium effect captures about 6% of variability (or $d \approx 0.5$). These effects are apparent to careful observation, although they are not obvious to a casual glance; 3) A large effect captures at least 15% of the variability (or $d \geq 0.8$). It is obvious to a superficial glance [195].

Pearson's correlation coefficient was created to quantify the degree of relationship between two variables. When applied to a sample, it is typically represented by r ($-1 \leq r \leq 1$), which is an index of the degree and direction of linear association between two continuous variables. These variables are usually denoted as X (predictor variable) and Y (outcome variable). Bivariate scatterplots are often used to visually inspect the degree of linear association between two variables. The absolute value of Pearson's correlation coefficient denotes the strength of the linear association. Moreover, the Pearson's correlation coefficient also provides a measure of the shared variance between two variables, which is calculated by squaring the coefficient, namely, coefficient of determination (r^2). The Pearson's correlation coefficient is calculated by finding the ratio of the covariance (CoV) of X and Y to the product of the standard deviations of X and Y .

$$r = \frac{CoV(X,Y)}{SD(X)SD(Y)} \quad (\text{A.15})$$

where SD denotes standard deviation.

In order to test the null hypothesis that the population correlation between X and Y is 0, t -distribution can be used to calculate a t score for r using

$$t = \frac{r\sqrt{n-2}}{\sqrt{1-r^2}} \quad (\text{A.16})$$

where r is the calculated correlation coefficient, n is the sample size. Then Compare the t score with the critical t value with $n-2$ degrees of freedom at a desired α level [196]. Pearson's correlation coefficients were calculated to study the relations between different variables in chapter 2, 4 and 5.

B. Multiple linear regression analysis

The regression model with one dependent variable and more than one independent variable, is known as multiple regression analysis. In chapter 3, the measured data with each interface were collected with five male subjects and nine combinations of grip (10, 30 and 50 N) and push (25, 50 and 75 N) forces. Multiple linear regression method was used to explore relationships among the grip (F_g), push (F_p) and contact (F_c) forces for three different hand-handle interfaces. The detailed procedures of multiple linear regression analysis are presented below. In general, linear regression involves two independent variables ($\varepsilon_1, \varepsilon_2$) and a response η . Suppose η is a function of these two variables, that is, $\eta = f(\varepsilon_1, \varepsilon_2)$. Provided the response is smooth over the experimenter's region of interest of ε_1 and ε_2 , this response function can often be usefully represented by a first order Taylor's series about a point $(\varepsilon_{10}, \varepsilon_{20})$ at the center of the region [197], that is,

$$\eta \cong f(\varepsilon_{10}, \varepsilon_{20}) + (\varepsilon_1, \varepsilon_{10}) \left. \frac{\partial f}{\partial \varepsilon_1} \right|_{\varepsilon_{10}, \varepsilon_{20}} + (\varepsilon_2, \varepsilon_{20}) \left. \frac{\partial f}{\partial \varepsilon_2} \right|_{\varepsilon_{10}, \varepsilon_{20}} \quad (\text{B.1})$$

Evaluating the derivatives $\frac{\partial f}{\partial \varepsilon_1}$ and $\frac{\partial f}{\partial \varepsilon_2}$ at the point $(\varepsilon_{10}, \varepsilon_{20})$ and collapsing terms gives the model

$$\eta = \alpha + \beta_1 \varepsilon_1 + \beta_2 \varepsilon_2 \quad (\text{B.2})$$

where α, β_1, β_2 are the coefficients. The assumptions of multiple linear regression analysis are normal distribution, linearity, freedom from extreme values and having no multiple ties between independent variables. Suppose that the observed y response is a random variable which is distributed with mean

$$E(y|\varepsilon_1, \varepsilon_2) = \eta = \alpha + \beta_1 \varepsilon_1 + \beta_2 \varepsilon_2 \quad (\text{B.3})$$

and variance σ^2 . In order to estimate $(\alpha, \beta_1, \beta_2)$, preselected points $(\varepsilon_{1i}, \varepsilon_{2i})$ of the controlled variables ε_1 and ε_2 observed, $i=1, \dots, n$. The least squares estimators of $(\alpha, \beta_1, \beta_2)$ could be found based on these data by minimizing the sum of squares.

$$Q(\alpha, \beta_1, \beta_2) = \sum (y_i - \alpha - \beta_1 \varepsilon_{1i} - \beta_2 \varepsilon_{2i})^2 \quad (\text{B.4})$$

With respect to α, β_1, β_2 , let a, b_1, b_2 be the values of α, β_1 and β_2 which minimize the sum of squares, that is, which satisfy the three equations $\partial Q/\partial \alpha = 0, \partial Q/\partial \beta_1 = 0$ and $\partial Q/\partial \beta_2 = 0$. Taking these indicated partial derivatives, and after some algebraic simplification, three normal equations are obtained:

$$n(a) + \sum x_1(b_1) + \sum x_2(b_2) = \sum y \quad (\text{B.5})$$

$$\sum x_1(a) + \sum x_1^2(b_1) + \sum x_1 x_2(b_2) = \sum x_1 y \quad (\text{B.6})$$

$$\sum x_2(a) + \sum x_1 x_2(b_1) + \sum x_2^2(b_2) = \sum x_2 y \quad (\text{B.7})$$

Provided the determinant of the coefficients of these equations does not equal zero, three unknowns a , b_1 , and b_2 could be obtained by solving above mentioned three equations.

C. Multivariate analysis of variance

Two-factor multivariate analysis of variance (MANOVA) was performed to determine the significant influences of different glove type and frequency range (M-/H-) as well as their interaction on the frequency-weighted palm and fingers' vibration transmissibility (Chapter 4). Three dependent variables are frequency-weighted palm vibration transmissibility, frequency-weighted vibration transmissibility of index and middle fingers. Two independent variables are glove type (10 *levels*) and frequency range (2 *levels*). In this scenario, if the analytic procedure comes to univariate analysis of variance (ANOVA) one for each dependent variable, the Type I and Type II error rates would be excessive inflation, moreover, the correlations among the dependent variables will not be able to consider [198]. These limitations can lead to inaccuracy in interpreting results. Both MANOVA and ANOVA designs are linear models in which a dependent variable (ANOVA) or multiple dependent variables (MANOVA) are expressed as a function of independent influence. Multivariate statistics are much more powerful than univariate statistic due to their ability to model different forms of relationships among variables [199]. Such truly multivariate modelling simply cannot be addressed by separate univariate analyses. MANOVA is basically a two-step process. The first step is to test the overall hypothesis of no differences in mean centroids for the different treatment groups. If this test is significant, the second step is to conduct post hoc tests to explain the group differences [200].

The multivariate two-factor model differs from the univariate model presented in Appendix A, the sums of squares in the partitioning of the MANOVA model are dealt with as matrix quantities rather than as scalar values of the sum of squares as in the ANOVA model. The multivariate null hypothesis can be written as

$$\begin{aligned}
 & \mu_{11} = \mu_{12} = \dots = \mu_{1k} \\
 & \mu_{21} = \mu_{22} = \dots = \mu_{2k} \\
 H_0: & \quad \quad \quad \vdots \quad \quad \quad \vdots \quad \quad \quad \vdots \quad \quad \quad \vdots \\
 & \mu_{p1} = \mu_{p2} = \dots = \mu_{pk}
 \end{aligned}$$

where μ_{mj} represent the population mean on variable m for group i . The range of m from 1 to p , while j ranges from 1 to k [201]. It means that for each variable all k groups have the same population mean. The alternative hypothesis in this case is that for at least one variable, there is at

least one group with a population mean different from the others. For the case in which there are three criterion variables, say X_1 , X_2 and X_3 , the basic data for the multivariate analysis of variance would take the form given in Table below.

Table A. 1: Basic data for the multivariate analysis of variance, $p = 3$

	Condition 1			Condition 2			...	Condition 3		
	X_1	X_2	X_3	X_1	X_2	X_3	...	X_1	X_2	X_3
	X_{111}	X_{121}	X_{131}	X_{112}	X_{122}	X_{132}	...	X_{11k}	X_{12k}	X_{13k}
	X_{211}	X_{221}	X_{231}	X_{212}	X_{222}	X_{232}	...	X_{21k}	X_{22k}	X_{23k}
Total	\vdots	\vdots	\vdots	\vdots	\vdots	\vdots	\vdots	\vdots	\vdots	\vdots
	X_{n11}	X_{n21}	X_{n31}	X_{n12}	X_{n22}	X_{n32}	...	X_{n1k}	X_{n2k}	X_{n3k}
	T_{11}	T_{21}	T_{31}	T_{12}	T_{22}	T_{32}	...	T_{1k}	T_{2k}	T_{3k}
	$G1 = \sum T_{1j}$			$G2 = \sum T_{2j}$...	$G3 = \sum T_{kj}$		

W and B matrices could be calculated:

$$W = \begin{bmatrix} W_{11} & W_{12} & W_{13} \\ W_{21} & W_{22} & W_{23} \\ W_{31} & W_{32} & W_{33} \end{bmatrix} \quad (C.1)$$

$$B = \begin{bmatrix} B_{11} & B_{12} & B_{13} \\ B_{21} & B_{22} & B_{23} \\ B_{31} & B_{32} & B_{33} \end{bmatrix} \quad (C.2)$$

where, $W_{11} = \sum X_{i1j}^2 - \frac{\sum T_{1j}^2}{n}$, $W_{22} = \sum X_{i2j}^2 - \frac{\sum T_{2j}^2}{n}$, $W_{33} = \sum X_{i3j}^2 - \frac{\sum T_{3j}^2}{n}$, $W_{12} = \sum X_{i1j}X_{i2j} - \frac{\sum X_{1j}X_{2j}}{n}$, $W_{13} = \sum X_{i1j}X_{i3j} - \frac{\sum X_{1j}X_{3j}}{n}$, $W_{23} = \sum X_{i2j}X_{i3j} - \frac{\sum X_{2j}X_{3j}}{n}$, $B_{11} = \frac{\sum T_{1j}^2}{n} - \frac{G_1^2}{kn}$, $B_{22} = \frac{\sum T_{2j}^2}{n} - \frac{G_2^2}{kn}$, $B_{33} = \frac{\sum T_{3j}^2}{n} - \frac{G_3^2}{kn}$, $B_{12} = \frac{\sum T_{1j}T_{2j}}{n} - \frac{G_1G_2}{kn}$, $B_{13} = \frac{\sum T_{1j}T_{3j}}{n} - \frac{G_1G_3}{kn}$, $B_{23} = \frac{\sum T_{2j}T_{3j}}{n} - \frac{G_2G_3}{kn}$ [188].

Note that W_{11} and B_{11} represent, respectively, the within-condition sum of squares and the between-condition sum of squares in the univariate analysis of variance for X_1 . Similarly, W_{22} and B_{22} , W_{33} and B_{33} are the corresponding sum of squares in the univariate analysis of variance for X_2 and X_3 , respectively. W_{12} and B_{12} represent the error and between-condition sum of squares associated with the cross products. These terms take the covariance between the criteria into account.

The W and B matrices are symmetric, which represent ‘due to experimental error’ and ‘due to conditions’, respectively.

The hypothesis H_0 can be tested by several methods and these methods do not lead to the same conclusions since they focus upon somewhat different ways of formulating the alternative hypothesis and the level of significance [188]. Each of the four multivariate test statistics in common usage is computed as a different function of the same eigenvalues. These methods include Wilks’s lambda (Λ), Pillai’s trace (V), Hotelling’s trace (T) and Roy’s greatest characteristic root criterion (θ) [198]. Here the Λ and θ methods are briefly described. The Λ approach for testing the hypothesis uses the statistic

$$\Lambda = \frac{|W|}{|W+B|} \quad (C.3)$$

In the general case, assuming H_0 is true, the statistic is approximately $F[2r, ms + 2\lambda]$. Where

$$m = kn - 1 - \frac{(p+k)}{2} \quad (C.4)$$

$$r = \frac{p(k-1)}{2} \quad (C.5)$$

$$s = \sqrt{\frac{p^2(k-1)^2-4}{p^2+(k-1)^2-5}} \quad (C.6)$$

$$\lambda = \frac{-1}{4} [p(k-1) - 2] \quad (C.7)$$

A more complete discussion of these sampling distributions will be found in [202].

An alternative test (θ) statistic [188] for use in testing the H_0 hypothesis is

$$\theta = \frac{\rho_{max}}{1+\rho_{max}} \quad (C.8)$$

where ρ_{max} is the largest characteristic root to BW^{-1} .

The significance of a MANOVA effect is common assessed by using the F -test approximation to any of the multivariate test statistics [198]. Two criteria are frequently used for the judgment of the adequacy of a statistical test, which are power and robustness. The power of a test is the probability that the test statistic will suggest rejection of the null hypothesis when the null hypothesis is false at some specified level. The robustness is the extent to the test statistic against violations of the assumptions that underlie the use of the approximate F -test. For the validation of the F -test, four assumptions are required to meet: 1) the sample is drawn at random from the population of interest; 2) the observations are independent; 3) the observations follow the multivariate normal distribution; and 4) the groups of any MANOVA factor have common within-

groups variance-covariance matrices which is consisted of two parts: the within-groups variances of the dependent variables are homogeneous, and the correlations between dependent variables are the same across the groups. If any effect in the MANOVA design achieves statistical significance, post hoc tests regarding the extent to which the individual dependent variables (more than two *levels*) contribute to the significant multivariate effect are subsequently conducted. The post hoc tests (e.g. Bonferroni and Tukey HSD) for ANOVA are presented in Appendix A. A similar but more complicated situation exist in MANOVA. Post hoc tests on any MANOVA classification variable may be conducted at the level of 1) the variance in the linear combinations of the variables, or 2) the variance in each of the separate univariate tests. More detailed about the classification variables can be found in [200].

References

- [1] ISO 5349-2 standard: *Mechanical Vibration—measurement and Evaluation of Human Exposure to Hand-Transmitted Vibration—Part 2*, 2001.
- [2] Y. Yao, S. Rakheja, C. Gauvin, P. Marcotte and K. Hamouda. Evaluation of effects of anti-vibration gloves on manual dexterity. *Ergonomics* pp. 1-15. 2018.
- [3] K. Hamouda, S. Rakheja, K. Dewangan and P. Marcotte. Fingers' vibration transmission and grip strength preservation performance of vibration reducing gloves. *Appl. Ergon.* 66pp. 121-138. 2018.
- [4] T. W. McDowell, R. G. Dong, D. E. Welcome, X. S. Xu and C. Warren. Vibration-reducing gloves: Transmissibility at the palm of the hand in three orthogonal directions. *Ergonomics* 56(12), pp. 1823-1840. 2013.
- [5] K. Hamouda, S. Rakheja, P. Marcotte and K. Dewangan. Fingers vibration transmission performance of vibration reducing gloves. *Int. J. Ind. Ergonomics* 62pp. 55-69. 2017.
- [6] D. E. Welcome, R. G. Dong, X. S. Xu, C. Warren and T. W. McDowell. The effects of vibration-reducing gloves on finger vibration. *Int. J. Ind. Ergonomics* 44(1), pp. 45-59. 2014.
- [7] M. Rezali, K. Anas and M. J. Griffin. The transmission of vibration through gloves to the hand and to the fingers: Effects of material dynamic stiffness. Presented at Applied Mechanics and Materials. 2014, .
- [8] K. A. Md Rezali and M. J. Griffin. Transmission of vibration through gloves: Effects of material thickness. *Ergonomics* 59(8), pp. 1026-1037. 2016.
- [9] K. A. Md Rezali and M. J. Griffin. Transmission of vibration through gloves: Effects of contact area. *Ergonomics* 60(1), pp. 69-81. 2017.
- [10] H. E. Laszlo and M. J. Griffin. The transmission of vibration through gloves: Effects of push force, vibration magnitude and inter-subject variability. *Ergonomics* 54(5), pp. 488-496. 2011.
- [11] ISO 10819 standard: Mechanical vibration and shock-hand-arm vibration—measurement and evaluation of the vibration transmissibility of gloves at the palm of the hand. 2013.
- [12] R. G. Dong, D. E. Welcome, T. W. McDowell and S. Rakheja. Estimation of the transmissibility of anti-vibration gloves when used with specific tools. *Noise Vibration Worldwide* 36(9), pp. 11-20. 2005.
- [13] R. G. Dong, D. E. Welcome and J. Z. Wu. Frequency weightings based on biodynamics of fingers-hand-arm system. *Ind. Health* 43(3), pp. 516-526. 2005.

- [14] I. Dianat, C. M. Haslegrave and A. W. Stedmon. Methodology for evaluating gloves in relation to the effects on hand performance capabilities: A literature review. *Ergonomics* 55(11), pp. 1429-1451. 2012.
- [15] I. Dianat, C. M. Haslegrave and A. W. Stedmon. Short and longer duration effects of protective gloves on hand performance capabilities and subjective assessments in a screw-driving task. *Ergonomics* 53(12), pp. 1468-1483. 2010.
- [16] Y. Yao, S. Rakheja and P. Marcotte. Relationship among hand forces imparted on a viscoelastic hand-handle interface. *Measurement* 2019.
- [17] P. Lemerle, A. Klinger, A. Cristalli and M. Geuder. Application of pressure mapping techniques to measure push and gripping forces with precision. *Ergonomics* 51(2), pp. 168-191. 2008.
- [18] C. Larivière, A. Plamondon, J. Lara, C. Tellier, J. Boutin and A. Dagenais. Biomechanical assessment of gloves. A study of the sensitivity and reliability of electromyographic parameters used to measure the activation and fatigue of different forearm muscles. *Int. J. Ind. Ergonomics* 34(2), pp. 101-116. 2004.
- [19] ISO 5349-1 standard: Mechanical vibration—measurement and evaluation of human exposure to hand-transmitted vibration—part 1: General requirements. *Geneva, Switzerland: International Organization for Standardization*, 2001.
- [20] R. Dong, S. Rakheja, A. Schopper, B. Han and W. Smutz. Hand-transmitted vibration and biodynamic response of the human hand-arm: A critical review. *Critical Reviews™ in Biomedical Engineering* 29(4), 2001.
- [21] US Department of Health and Human Services. Criteria for a recommended standard: Occupational exposure to hand-arm vibration. *DHHS (NIOSH) Publication* pp. 89-106. 1989.
- [22] R. Gurram, S. Rakheja and G. Gouw. Mechanical impedance of the human hand-arm system subject to sinusoidal and stochastic excitations. *Int. J. Ind. Ergonomics* 16(2), pp. 135-145. 1995.
- [23] L. N. Nemani. *Vibration Analysis of a Hand-Grinder System Under Wheel Unbalance Excitation* 2005.
- [24] R. Gurram. *A Study of Vibration Response Characteristics of the Human Hand-Arm System* 1993.
- [25] P. Pitts. Hand-arm vibration emission of chainsaws—comparison with vibration exposure. *Health and Safety Laboratory, Derbyshire, UK* 2004.
- [26] M. Futatsuka and T. Ueno. Vibration exposure and vibration-induced white finger due to chain saw operation. *Journal of Occupational and Environmental Medicine* 27(4), pp. 257-264. 1985.

- [27] R. Radwin, T. Armstrong and E. Van Bergeijk. Hand-arm vibration and work-related disorders of the upper limb. *Hand-Arm Vibration. A Comprehensive Guide for Occupational Health Professionals*. Ed. New York: Van Nostrand Reinhold pp. 122-152. 1992.
- [28] E. Directive and G. Provisions. Directive 2002/44/EC of the European parliament and the council of 25 June 2002 on the minimum health and safety requirements regarding the exposure of workers to the risks arising from physical agents (vibration) (sixteenth individual directive within the meaning of article 16 (1) of directive 89/391/EEC). *Official Journal of the European Communities, L 117(13)*, pp. 6.7. 2002.
- [29] R. L. Brubaker, C. Mackenzie and S. G. Hutton. Vibration-induced white finger among selected underground rock drillers in British Columbia. *Scand. J. Work Environ. Health* pp. 296-300. 1986.
- [30] R. Dandanell and K. Engström. Vibration from riveting tools in the frequency range 6 Hz—10 MHz and Raynaud's phenomenon. *Scand. J. Work Environ. Health* pp. 338-342. 1986.
- [31] K. Engström and R. Dandanell. Exposure conditions and Raynaud's phenomenon among riveters in the aircraft industry. *Scand. J. Work Environ. Health* pp. 293-295. 1986.
- [32] M. J. Griffin, M. Bovenzi and C. M. Nelson. Dose-response patterns for vibration-induced white finger. *Occup. Environ. Med.* 60(1), pp. 16-26. 2003.
- [33] M. Bovenzi. Health effects of mechanical vibration. *G. Ital. Med. Lav. Ergon.* 27(1), pp. 58-64. 2005.
- [34] P. M. Pitts, H. J. Mason, K. A. Poole and C. E. Young. Relative performance of frequency weighting W_h and candidates for alternative frequency weightings for predicting the occurrence of hand-transmitted vibration-induced injuries. *Ind. Health* 50(5), pp. 388-396. 2012.
- [35] R. G. Dong, D. E. Welcome, T. W. McDowell, J. Z. Wu and A. W. Schopper. Frequency weighting derived from power absorption of fingers–hand–arm system under z_h -axis vibration. *J. Biomech.* 39(12), pp. 2311-2324. 2006.
- [36] M. Bovenzi. Epidemiological evidence for new frequency weightings of hand-transmitted vibration. *Ind. Health* 50(5), pp. 377-387. 2012.
- [37] A. N. Rimell and N. J. Mansfield. Design of digital filters for frequency weightings required for risk assessments of workers exposed to vibration. *Ind. Health* 45(4), pp. 512-519. 2007.
- [38] J. H. Dong, R. G. Dong, S. Rakheja, D. E. Welcome, T. W. McDowell and J. Z. Wu. A method for analyzing absorbed power distribution in the hand and arm substructures when operating vibrating tools. *J. Sound Vibrat.* 311(3), pp. 1286-1304. 2008.

- [39] R. G. Dong, D. E. Welcome, T. W. McDowell, X. S. Xu, K. Krajnak and J. Z. Wu. A proposed theory on biodynamic frequency weighting for hand-transmitted vibration exposure. *Ind. Health* 50(5), pp. 412-424. 2012.
- [40] Y. Tominaga. New frequency weighting of hand-arm vibration. *Ind. Health* 43(3), pp. 509-515. 2005.
- [41] ISO/TR 18570 standard: mechanical vibration – measurement and evaluation of human exposure to hand-transmitted vibration – supplementary method for assessing risk of vascular injury, Tech. Rep., 2016.
- [42] J. Lin, R. G. Radwin and T. G. Richard. Dynamic biomechanical model of the hand and arm in pistol grip power handtool usage. *Ergonomics* 44(3), pp. 295-312. 2001.
- [43] G. Gemne and W. Taylor. *Hand-Arm Vibration and the Central Autonomic Nervous System* 1983.
- [44] P. L. Pelmeur, W. Taylor, D. Wasserman and D. J. Fletcher. Hand-arm vibration: A comprehensive guide for occupational health professionals. *Journal of Occupational and Environmental Medicine* 35(5), pp. 533. 1993.
- [45] M. J. Griffin. *Handbook of Human Vibration* 2012.
- [46] L. Punnett and D. H. Wegman. Work-related musculoskeletal disorders: The epidemiologic evidence and the debate. *Journal of Electromyography and Kinesiology* 14(1), pp. 13-23. 2004.
- [47] M. Hagberg. Clinical assessment of musculoskeletal disorders in workers exposed to hand-arm vibration. *Int. Arch. Occup. Environ. Health* 75(1-2), pp. 97-105. 2002.
- [48] J. Muggleton, R. Allen and P. Chappell. Hand and arm injuries associated with repetitive manual work in industry: A review of disorders, risk factors and preventive measures. *Ergonomics* 42(5), pp. 714-739. 1999.
- [49] Y. Kawano, H. M. Mahbub, R. Hase, T. Sakamoto and N. Harada. Analysis of long-term stored plasma samples for investigation into the pathophysiology of vibration-induced white finger: Preliminary results. *Ind. Health* 52(6), pp. 548-551. 2014. DOI: DN/JST.JSTAGE/indhealth/2014-0057 [pii].
- [50] Y. Ye and M. J. Griffin. Relation between vibrotactile perception thresholds and reductions in finger blood flow induced by vibration of the hand at frequencies in the range 8–250 Hz. *Eur. J. Appl. Physiol.* 114(8), pp. 1591-1603. 2014.
- [51] K. Miyashita, S. Shiomi, N. Itoh, T. Kasamatsu and H. Iwata. Epidemiological study of vibration syndrome in response to total hand-tool operating time. *Br. J. Ind. Med.* 40(1), pp. 92-98. 1983.

- [52] M. Farkkila, I. Pyykko, J. Starck and O. Korhonen. *Hand Grip Force and Muscle Fatigue in the Etiology of the Vibration Syndrome* 1982.
- [53] M. Färkkilä, I. Pyykkö, O. Korhonen and J. Starck. Vibration-induced decrease in the muscle force in lumberjacks. *Eur. J. Appl. Physiol. Occup. Physiol.* 43(1), pp. 1-9. 1980.
- [54] M. Bovenzi. Exposure-response relationship in the hand-arm vibration syndrome: An overview of current epidemiology research. *Int. Arch. Occup. Environ. Health* 71(8), pp. 509-519. 1998.
- [55] H. Harkonen, H. Riihimaki, S. Tola, T. Mattsson, M. Pekkarinen, A. Zitting and K. Husman. Symptoms of vibration syndrome and radiographic findings in the wrists of lumberjacks. *Br. J. Ind. Med.* 41(1), pp. 133-136. 1984.
- [56] D. Reynolds and R. Falkenberg. A study of hand vibration on chipping and grinding operators, part II: Four-degree-of-freedom lumped parameter model of the vibration response of the human hand. *J. Sound Vibrat.* 95(4), pp. 499-514. 1984.
- [57] D. Reynolds, R. Basel, D. Wasserman and W. Taylor. A study of hand vibration on chipping and grinding operators, part III: Power levels into the hands of operators of pneumatic tools used in chipping and grinding operations. *J. Sound Vibrat.* 95(4), pp. 515-524. 1984.
- [58] S. Hewitt, R. G. Dong, D. E. Welcome and T. W. McDowell. Anti-vibration gloves? *Ann. Occup. Hyg.* 59(2), pp. 127-141. 2014.
- [59] V. Tewari and K. Dewangan. Effect of vibration isolators in reduction of work stress during field operation of hand tractor. *Biosystems Engineering* 103(2), pp. 146-158. 2009.
- [60] C. Suggs and C. Abrams. Vibration isolation of power tool operators. Presented at Proceedings of the Human Factors and Ergonomics Society Annual Meeting. 1983, .
- [61] I. Sokolov, V. Babitsky and N. Halliwell. Hand-held percussion machines with low emission of hazardous vibration. *J. Sound Vibrat.* 306(1-2), pp. 59-73. 2007.
- [62] B. Sam and K. Kathirvel. Development and evaluation of vibration isolators for reducing hand transmitted vibration of walking and riding type power tillers. *Biosystems Engineering* 103(4), pp. 427-437. 2009.
- [63] J. Strydom, P. Heyns and J. Van Niekerk. Development of a vibration absorbing handle for rock drills. *J. S. Afr. Inst. Min. Metall.* 102(3), pp. 167-172. 2002.
- [64] K. Y. Hao, L. X. Mei and Z. M. Ripin. Tuned vibration absorber for suppression of hand-arm vibration in electric grass trimmer. *Int. J. Ind. Ergonomics* 41(5), pp. 494-508. 2011.
- [65] T. Cherian, S. Rakheja and R. Bhat. An analytical investigation of an energy flow divider to attenuate hand-transmitted vibration. *Int. J. Ind. Ergonomics* 17(6), pp. 455-467. 1996.

- [66] H. Lindell. Redesign of hand-held impact machines to reduce hand-arm vibration. *Can. Acoustics* 39(2), pp. 80-81. 2011.
- [67] I. Pinto, N. Stacchini, M. Bovenzi, G. Paddan and M. Griffin. Protection effectiveness of anti-vibration gloves: Field evaluation and laboratory performance assessment. Presented at Proceedings of the 9th International Conference on Hand-Arm Vibration. 2001.
- [68] R. Dong, S. Rakheja, T. McDowell, D. Welcome, J. Wu, C. Warren, J. Barkley, B. Washington and A. Schopper. A method for assessing the effectiveness of anti-vibration gloves using biodynamic responses of the hand–arm system. *J. Sound Vibrat.* 282(3), pp. 1101-1118. 2005.
- [69] R. Dong, T. McDowell, D. Welcome and W. Smutz. Correlations between biodynamic characteristics of human hand–arm system and the isolation effectiveness of anti-vibration gloves. *Int. J. Ind. Ergonomics* 35(3), pp. 205-216. 2005.
- [70] R. G. Dong, T. W. McDowell, D. E. Welcome, W. P. Smutz, A. W. Schopper, C. Warren, J. Z. Wu and S. Rakheja. On-the-hand measurement methods for assessing effectiveness of anti-vibration gloves. *Int. J. Ind. Ergonomics* 32(4), pp. 283-298. 2003. DOI: [http://dx.doi.org/10.1016/S0169-8141\(03\)00071-4](http://dx.doi.org/10.1016/S0169-8141(03)00071-4).
- [71] R. G. Dong, D. E. Welcome, D. R. Peterson, X. S. Xu, T. W. McDowell, C. Warren, T. Asaki, S. Kudernatsch and A. Brammer. Tool-specific performance of vibration-reducing gloves for attenuating palm-transmitted vibrations in three orthogonal directions. *Int. J. Ind. Ergonomics* 44(6), pp. 827-839. 2014.
- [72] M. Carre, A. Almagirby, J. Walton and J. Rongong. Vibration transmissibility measurement of glove materials under different grip forces. Presented at Proceedings of 50th UK Conference on Human Responses to Vibration. 2015.
- [73] ISO 10819 standard: Mechanical vibration and shock–Hand-arm vibration–method for the measurement and evaluation of the vibration transmissibility of gloves at the palm of the hand, *International Organization of Standards, Geneva, Switzerland*, 1996.
- [74] X. S. Xu, D. A. Riley, M. Persson, D. E. Welcome, K. Krajnak, J. Z. Wu, S. R. Govinda Raju and R. G. Dong. Evaluation of anti-vibration effectiveness of glove materials using an animal model. *Biomed. Mater. Eng.* 21(4), pp. 193-211. 2011.
- [75] R. G. Dong, D. E. Welcome, J. Z. Wu and T. W. McDowell. Development of hand-arm system models for vibrating tool analysis and test rig construction. *Noise Control Eng. J.* 56(1), pp. 35-44. 2008.
- [76] M. Fritz. An improved biomechanical model for simulating the strain of the hand-arm system under vibration stress. *J. Biomech.* 24(12), pp. 1165-1171. 1991.

- [77] R. Jahn and M. Hesse. Applications of hand-arm models in the investigation of the interaction between man and machine. *Scand. J. Work Environ. Health* pp. 343-346. 1986.
- [78] A. Almagirby, M. J. Carré and J. A. Rongong. A new methodology for measuring the vibration transmission from handle to finger whilst gripping. *Int. J. Ind. Ergonomics* 58pp. 55-61. 2017.
- [79] R. G. Dong, D. E. Welcome, T. W. McDowell and J. Z. Wu. Modeling of the biodynamic responses distributed at the fingers and palm of the hand in three orthogonal directions. *J. Sound Vibrat.* 332(4), pp. 1125-1140. 2013.
- [80] S. Rakheja, R. Dong, D. Welcome and A. Schopper. Estimation of tool-specific isolation performance of antivibration gloves. *Int. J. Ind. Ergonomics* 30(2), pp. 71-87. 2002.
- [81] F. Akbar-Khanzadeh, M. S. Bisesi and R. D. Rivas. Comfort of personal protective equipment. *Appl. Ergon.* 26(3), pp. 195-198. 1995.
- [82] G. S. Sorock, D. A. Lombardi, D. K. Peng, R. Hauser, E. A. Eisen, R. F. Herrick and M. A. Mittleman. Glove use and the relative risk of acute hand injury: A case-crossover study. *Journal of Occupational and Environmental Hygiene* 1(3), pp. 182-190. 2004.
- [83] C. A. Ervin. A standardized dexterity test battery. Presented at Performance of Protective Clothing: Second Symposium. 1988.
- [84] G. K. Bennett. *Hand-Tool Dexterity Test* 1981.
- [85] Y. Wang, R. Wickstrom, S. Yen, J. Kapellusch and K. A. Grogan. Assessing manual dexterity: Comparing the workability rate of manipulation test with the minnesota manual dexterity test. *Journal of Hand Therapy* 31(3), pp. 339-347. 2018.
- [86] C. E. Jurgensen. Extension of the minnesota rate of manipulation test. *J. Appl. Psychol.* 27(2), pp. 164. 1943.
- [87] M. Hines and J. O'Connor. A measure of finger dexterity. *Pers. J.* 4pp. 379-382. 1926.
- [88] J. Tiffin and E. J. Asher. The purdue pegboard: Norms and studies of reliability and validity. *J. Appl. Psychol.* 32(3), pp. 234. 1948.
- [89] A. Muralidhar, R. R. Bishu and M. Hallbeck. The development and evaluation of an ergonomic glove. *Appl. Ergon.* 30(6), pp. 555-563. 1999.
- [90] R. R. Bishu, G. Klute and B. Kim. The effects of extra vehicular activity (EVA) gloves on dexterity and tactility. Presented at Proceedings of the Human Factors and Ergonomics Society Annual Meeting. 1993.

- [91] ASTM F2010, Standard test method for evaluation of glove effects on wearer hand dexterity using a modified pegboard test, 2010.
- [92] C. Gauvin, C. Tellier, R. Daigle and T. Petitjean-Roget, *Évaluation de tests de dextérité appliqués aux gants de protection*, IRSST, Montréal, Tech. Rep. Rapport R-491, 2007.
- [93] J. V. Bradley. Effect of gloves on control operation time. *Human Factors: The Journal of the Human Factors and Ergonomics Society* 11(1), pp. 13-20. 1969.
- [94] R. Plummer, T. Stobbe, R. Ronk, W. Myers, H. Kim and M. Jaraiedi. Manual dexterity evaluation of gloves used in handling hazardous materials. Presented at Proceedings of the Human Factors Society Annual Meeting. 1985, .
- [95] W. W. Banks. The effects of degraded visual and tactile information on diver work performance. *Hum. Factors* 21(4), pp. 409-415. 1979.
- [96] K. Willms, R. Wells and H. Carnahan. Glove attributes and their contribution to force decrement and increased effort in power grip. *Hum. Factors* 51(6), pp. 797-812. 2009.
- [97] C. K. Bensel. The effects of various thicknesses of chemical protective gloves on manual dexterity. *Ergonomics* 36(6), pp. 687-696. 1993.
- [98] J. B. Nelson and A. Mital. An ergonomic evaluation of dexterity and tactility with increase in examination/surgical glove thickness. *Ergonomics* 38(4), pp. 723-733. 1995.
- [99] K. M. Rock, R. P. Mikat and C. Foster. The effects of gloves on grip strength and three-point pinch. *Journal of Hand Therapy* 14(4), pp. 286-290. 2001.
- [100] B. Wimer, T. W. McDowell, X. S. Xu, D. E. Welcome, C. Warren and R. G. Dong. Effects of gloves on the total grip strength applied to cylindrical handles. *Int. J. Ind. Ergonomics* 40(5), pp. 574-583. 2010.
- [101] M. Färkkiälä, S. Aatola, J. Starck, O. Korhonen and I. Pyykkö. Hand-grip force in lumberjacks: Two-year follow-up. *Int. Arch. Occup. Environ. Health* 58(3), pp. 203-208. 1986.
- [102] C. Chang and Y. Shih. The effects of glove thickness and workload on female hand performance and fatigue during an infrequent high-intensity gripping task. *Appl. Ergon.* 38(3), pp. 317-324. 2007.
- [103] L. Sudhakar, R. Schoenmarklin, S. Lavender and W. Marras. The effects of gloves on grip strength and muscle activity. Presented at Proceedings of the Human Factors Society Annual Meeting. 1988.
- [104] D. C. Buhman, J. A. Cherry, L. Bronkema-Orr and R. Bishu. Effects of glove, orientation, pressure, load, and handle on submaximal grasp force. *Int. J. Ind. Ergonomics* 25(3), pp. 247-256. 2000.

- [105] G. Waddington, J. Diong and R. Adams. Development of a hand dynamometer for the control of manually applied forces. *J. Manipulative Physiol. Ther.* 29(4), pp. 297-304. 2006.
- [106] R. G. Dong, J. Z. Wu, D. E. Welcome and T. W. McDowell. A new approach to characterize grip force applied to a cylindrical handle. *Med. Eng. Phys.* 30(1), pp. 20-33. 2008.
- [107] B. Wimer, R. G. Dong, D. E. Welcome, C. Warren and T. W. McDowell. Development of a new dynamometer for measuring grip strength applied on a cylindrical handle. *Med. Eng. Phys.* 31(6), pp. 695-704. 2009.
- [108] Y. Aldien, D. Welcome, S. Rakheja, R. Dong and P. Boileau. Contact pressure distribution at hand–handle interface: Role of hand forces and handle size. *Int. J. Ind. Ergonomics* 35(3), pp. 267-286. 2005.
- [109] D. E. Welcome, R. G. Dong, X. S. Xu, C. Warren and T. W. McDowell. An evaluation of the proposed revision of the anti-vibration glove test method defined in ISO 10819 (1996). *Int. J. Ind. Ergonomics* 1(42), pp. 143-155. 2012.
- [110] M. Jung and M. S. Hallbeck. Quantification of the effects of instruction type, verbal encouragement, and visual feedback on static and peak handgrip strength. *Int. J. Ind. Ergonomics* 34(5), pp. 367-374. 2004.
- [111] R. Gurram, S. Rakheja and G. Gouw. A study of hand grip pressure distribution and EMG of finger flexor muscles under dynamic loads. *Ergonomics* 38(4), pp. 684-699. 1995.
- [112] K. N. Bachus, A. L. DeMarco, K. T. Judd, D. S. Horwitz and D. S. Brodke. Measuring contact area, force, and pressure for bioengineering applications: Using fuji film and TekScan systems. *Med. Eng. Phys.* 28(5), pp. 483-488. 2006.
- [113] M. Kalra, S. Rakheja, P. Marcotte, K. Dewangan and S. Adewusi. Measurement of coupling forces at the power tool handle-hand interface. *Int. J. Ind. Ergonomics* 50pp. 105-120. 2015.
- [114] D. Welcome, S. Rakheja, R. Dong, J. Wu and A. Schopper. An investigation on the relationship between grip, push and contact forces applied to a tool handle. *Int. J. Ind. Ergonomics* 34(6), pp. 507-518. 2004.
- [115] C. Larivière, G. Tremblay, S. Nadeau, L. Harrabi, P. Dolez, T. Vu-Khanh and J. Lara. Do mechanical tests of glove stiffness provide relevant information relative to their effects on the musculoskeletal system? A comparison with surface electromyography and psychophysical methods. *Appl. Ergon.* 41(2), pp. 326-334. 2010.
- [116] R. Wells, S. Hunt, K. Hurley and P. Rosati. Laboratory assessment of the effect of heavy rubber glove thickness and sizing on effort, performance and comfort. *Int. J. Ind. Ergonomics* 40(4), pp. 386-391. 2010.

- [117] V. Gnaneswaran and R. R. Bishu. Anthropometry and hand performance evaluation of minority population. *Int. J. Ind. Ergonomics* 41(6), pp. 661-670. 2011.
- [118] W. Taylor. Biological effects of the hand–arm vibration syndrome: Historical perspective and current research. *J. Acoust. Soc. Am.* 83(2), pp. 415-422. 1988.
- [119] S. L. Fleming, C. W. Jansen and S. M. Hasson. Effect of work glove and type of muscle action on grip fatigue. *Ergonomics* 40(6), pp. 601-612. 1997.
- [120] Eastman Kodak Company. *Kodak's Ergonomic Design for People at Work* 2004.
- [121] EN 420 standard: Protective gloves general requirements and test methods, 2010.
- [122] K. Dandekar, B. I. Raju and M. A. Srinivasan. 3-D finite-element models of human and monkey fingertips to investigate the mechanics of tactile sense. *J. Biomech. Eng.* 125(5), pp. 682-691. 2003.
- [123] T. Francis and S. Anandhi. Correlation between thumb length on handgrip strength, hand dexterity and musculoskeletal problem among dental professional. *Brazilian Dental Science* 19(3), pp. 23-31. 2016.
- [124] S. Adewusi, S. Rakheja, P. Marcotte and J. Boutin. Vibration transmissibility characteristics of the human hand–arm system under different postures, hand forces and excitation levels. *J. Sound Vibrat.* 329(14), pp. 2953-2971. 2010.
- [125] Y. Aldien, P. Marcotte, S. Rakheja and P. BOILEAU. Mechanical impedance and absorbed power of hand-arm under xh-axis vibration and role of hand forces and posture. *Ind. Health* 43(3), pp. 495-508. 2005.
- [126] CEN/TR 16391:2012, Mechanical vibration and shock- hand transmitted vibration — influence of coupling forces at the hand-machine interface on exposure evaluation, Tech. Rep., 2012.
- [127] ISO 15230 standard: Mechanical vibration and shock - Coupling forces at the man-machine interface for hand-transmitted vibration, *International Organization for Standardization, Geneva*, 2007.
- [128] L. Vigouroux, F. Quaine, A. Labarre-Vila, D. Amarantini and F. Moutet. Using EMG data to constrain optimization procedure improves finger tendon tension estimations during static fingertip force production. *J. Biomech.* 40(13), pp. 2846-2856. 2007.
- [129] E. J. Huesler, M. A. Maier and M. Hepp-Reymond. EMG activation patterns during force production in precision grip. III. synchronisation of single motor units. *Experimental Brain Research* 134(4), pp. 441-455. 2000.

- [130] I. Horsley, L. Herrington, R. Hoyle, E. Prescott and N. Bellamy. Do changes in hand grip strength correlate with shoulder rotator cuff function? *Shoulder & Elbow* 8(2), pp. 124-129. 2016.
- [131] D. Welcome, S. Rakheja, R. Dong, B. Westfall and A. Schopper. A preliminary study of the relationship of hand grip and push forces to total coupling forces. Presented at Proceedings of the UK Informal Group Meeting on Human Responses to Vibration. 2001, .
- [132] P. Marcotte, Y. Aldien, P. Boileau, S. Rakheja and J. Boutin. Effect of handle size and hand–handle contact force on the biodynamic response of the hand–arm system under z_h -axis vibration. *J. Sound Vibrat.* 283(3), pp. 1071-1091. 2005.
- [133] N. J. Seo and T. J. Armstrong. Investigation of grip force, normal force, contact area, hand size, and handle size for cylindrical handles. *Hum. Factors* 50(5), pp. 734-744. 2008.
- [134] S. Odenwald and D. Krumm. Effects of elastic compression sleeves on the biodynamic response to external vibration of the hand-arm system. *Procedia Engineering* 72pp. 114-119. 2014.
- [135] J. G. Young, C. Woolley, T. J. Armstrong and J. A. Ashton-Miller. Hand-handhold coupling: Effect of handle shape, orientation, and friction on breakaway strength. *Hum. Factors* 51(5), pp. 705-717. 2009.
- [136] C. Savva, C. Karagiannis and A. Rushton. Test–retest reliability of grip strength measurement in full elbow extension to evaluate maximum grip strength. *Journal of Hand Surgery (European Volume)* 38(2), pp. 183-186. 2013.
- [137] J. G. Young, C. B. Woolley, J. A. Ashton-Miller and T. J. Armstrong. The effect of handhold orientation, size, and wearing gloves on hand-handhold breakaway strength. *Hum. Factors* 54(3), pp. 316-333. 2012.
- [138] N. J. Seo, T. J. Armstrong, J. A. Ashton-Miller and D. B. Chaffin. The effect of torque direction and cylindrical handle diameter on the coupling between the hand and a cylindrical handle. *J. Biomech.* 40(14), pp. 3236-3243. 2007.
- [139] C. B. Irwin, J. D. Towles and R. G. Radwin. Multiaxis grip characteristics for varying handle diameters and effort. *Hum. Factors* 57(2), pp. 227-237. 2015.
- [140] T. Fukubayashi and H. Kurosawa. The contact area and pressure distribution pattern of the knee: A study of normal and osteoarthrotic knee joints. *Acta Orthop. Scand.* 51(1-6), pp. 871-879. 1980.
- [141] D. Wirz, R. Becker, S. Feng Li, N. Friedrich and W. Müller. Validation of the tekscan system for static and dynamic pressure measurements in the human femorotibial joint. *Biomedical Engineering* 47(7-8), pp. 195-201. 2002.

- [142] P. Misiewicz, K. Blackburn, T. Richards, J. Brighton and R. Godwin. The evaluation and calibration of pressure mapping system for the measurement of the pressure distribution of agricultural tyres. *Biosystems Engineering* 130 pp. 81-91. 2015.
- [143] J. G. Young, M. E. Sackllah and T. J. Armstrong. Force distribution at the hand/handle interface for grip and pull tasks. Presented at Proceedings of the Human Factors and Ergonomics Society Annual Meeting. 2010, .
- [144] A. Mastalerz, E. Nowak, I. Palczewska and E. Kalka. Maximal grip force during holding a cylindrical handle with different diameters. *Human Movement* 10(1), pp. 26-30. 2009.
- [145] Tekscan, I-scan & high-speed I-scan user manual, 2012.
- [146] J. Rossi, E. Berton, L. Grélot, C. Barla and L. Vigouroux. Characterisation of forces exerted by the entire hand during the power grip: Effect of the handle diameter. *Ergonomics* 55(6), pp. 682-692. 2012.
- [147] D. Wilson, M. V. Apreleva, M. J. Eichler and F. R. Harrold. Accuracy and repeatability of a pressure measurement system in the patellofemoral joint. *J. Biomech.* 36(12), pp. 1909-1915. 2003.
- [148] M. Ferguson-Pell, S. Hagiwara and D. Bain. Evaluation of a sensor for low interface pressure applications. *Med. Eng. Phys.* 22(9), pp. 657-663. 2000.
- [149] J. M. Brimacombe, D. R. Wilson, A. J. Hodgson, K. C. Ho and C. Anglin. Effect of calibration method on tekscan sensor accuracy. *J. Biomech. Eng.* 131(3), pp. 034503. 2009.
- [150] M. Kalra. *Development and Assessment of a Coupling Force Measurement System Applied to Stationary and Vibrating Tool Handles*, 2014.
- [151] Tekscan, I-scan™ product selection guide.
- [152] E. R. Komi, J. R. Roberts and S. Rothberg. Evaluation of thin, flexible sensors for time-resolved grip force measurement. *Proc. Inst. Mech. Eng. Part C* 221(12), pp. 1687-1699. 2007.
- [153] A. J. Shaw, B. A. Davis, M. J. Collins and L. G. Carney. A technique to measure eyelid pressure using piezoresistive sensors. *IEEE Transactions on Biomedical Engineering* 56(10), pp. 2512-2517. 2009.
- [154] Y. S. Aldien. *A Study of Hand-Handle Interactions and Hand-Arm Biodynamic Response to Vibration* 2005.
- [155] E. G. Tasker. Assessment of vibration levels associated with hand-held roadbreakers. *Scand. J. Work Environ. Health* pp. 407-412. 1986.

- [156] M. Bovenzi, A. Franzinelli and F. Strambi. Prevalence of vibration-induced white finger and assessment of vibration exposure among travertine workers in Italy. *Int. Arch. Occup. Environ. Health* 61(1-2), pp. 25-34. 1988.
- [157] M. Bovenzi, A. Franzinelli, R. Mancini, M. G. Cannava, M. Maiorano and F. Ceccarelli. Dose-response relation for vascular disorders induced by vibration in the fingers of forestry workers. *Occup. Environ. Med.* 52(11), pp. 722-730. 1995.
- [158] M. Bovenzi, I. Pinto and F. Picciolo. Risk assessment of vascular disorders by a supplementary hand–arm vascular weighting of hand-transmitted vibration. *Int. Arch. Occup. Environ. Health* 92(1), pp. 129-139. 2019.
- [159] R. G. Dong, D. E. Welcome, T. W. McDowell, J. Z. Wu and A. W. Schopper. Frequency weighting derived from power absorption of fingers–hand–arm system under z_h -axis vibration. *J. Biomech.* 39(12), pp. 2311-2324. 2006.
- [160] K. A. Md Rezali and M. J. Griffin. Transmission of vibration through glove materials: Effects of contact force. *Ergonomics* 61(9), pp. 1246-1258. 2018.
- [161] R. G. Dong, T. W. McDowell, D. E. Welcome, C. Warren, J. Z. Wu and S. Rakheja. Analysis of anti-vibration gloves mechanism and evaluation methods. *J. Sound Vibrat.* 321(1), pp. 435-453. 2009.
- [162] W. Thomson. *Theory of Vibration with Applications* 2018.
- [163] R. Dong, S. Rakheja, W. Smutz, A. Schopper, D. Welcome and J. Wu. Effectiveness of a new method (TEAT) to assess vibration transmissibility of gloves. *Int. J. Ind. Ergonomics* 30(1), pp. 33-48. 2002.
- [164] R. Dong, J. Wu, T. McDowell, D. Welcome and A. Schopper. Distribution of mechanical impedance at the fingers and the palm of the human hand. *J. Biomech.* 38(5), pp. 1165-1175. 2005.
- [165] M. J. Griffin. Evaluating the effectiveness of gloves in reducing the hazards of hand-transmitted vibration. *Occup. Environ. Med.* 55(5), pp. 340-348. 1998.
- [166] B. A. Silverstein, L. J. Fine and T. J. Armstrong. Occupational factors and carpal tunnel syndrome. *Am. J. Ind. Med.* 11(3), pp. 343-358. 1987.
- [167] J. Basmajian and R. Blumenstein. Electrode placement in electromyographic feedback. *Biofeedback. Principles and Practice for Clinicians. 2nd Edn. Williams and Wilkins, Baltimore* 1983.
- [168] D. Lakens. Calculating and reporting effect sizes to facilitate cumulative science: A practical primer for t-tests and ANOVAs. *Frontiers in Psychology* 4 pp. 863. 2013.

- [169] J. P. Mogk and P. J. Keir. Crosstalk in surface electromyography of the proximal forearm during gripping tasks. *Journal of Electromyography and Kinesiology* 13(1), pp. 63-71. 2003.
- [170] F. Danion, S. Li, V. M. Zatsiorsky and M. L. Latash. Relations between surface EMG of extrinsic flexors and individual finger forces support the notion of muscle compartments. *Eur. J. Appl. Physiol.* 88(1-2), pp. 185-188. 2002.
- [171] F. Danion, M. Latash, Z. Li and V. Zatsiorsky. The effect of fatigue on multifinger coordination in force production tasks in humans. *J. Physiol. (Lond.)* 523(2), pp. 523-532. 2000.
- [172] K. Kovacs, R. Splittstoesser, A. Maronitis and W. S. Marras. Grip force and muscle activity differences due to glove type. *AIHA Journal* 63(3), pp. 269-274. 2002.
- [173] A. Sirin and A. Patla. Myoelectric changes in the triceps surae muscles under sustained contractions. *Eur. J. Appl. Physiol. Occup. Physiol.* 56(2), pp. 238-244. 1987.
- [174] C. Larivière, A. Arsenault, D. Gravel, D. Gagnon and P. Loisel. Evaluation of measurement strategies to increase the reliability of EMG indices to assess back muscle fatigue and recovery. *Journal of Electromyography and Kinesiology* 12(2), pp. 91-102. 2002.
- [175] C. Larivière, D. Gagnon, D. Gravel and A. B. Arsenault. The assessment of back muscle capacity using intermittent static contractions. part I—Validity and reliability of electromyographic indices of fatigue. *Journal of Electromyography and Kinesiology* 18(6), pp. 1006-1019. 2008.
- [176] L. Harrabi, P. I. Dolez, T. Vu-Khanh, J. Lara, G. Tremblay, S. Nadeau and C. Larivière. Characterization of protective gloves stiffness: Development of a multidirectional deformation test method. *Saf. Sci.* 46(7), pp. 1025-1036. 2008.
- [177] M. Zeleny. *Multiple Criteria Decision Making Kyoto 1975 2012123*.
- [178] T. L. Saaty, *The Analytic Hierarchy Process*. New York: McGraw-Hill Book Co., 1980.
- [179] E. H. Forman and S. I. Gass. The analytic hierarchy process—an exposition. *Oper. Res.* 49(4), pp. 469-486. 2001.
- [180] E. W. Cheng and H. Li. Analytic hierarchy process. *Measuring Business Excellence* 2001.
- [181] P. T. Harker and L. G. Vargas. The theory of ratio scale estimation: Saaty's analytic hierarchy process. *Management Science* 33(11), pp. 1383-1403. 1987.
- [182] Yao, Y., Rakheja S., Larivière C., Marcotte P., Measurement of forearm muscle activities to study anti-vibration gloves: sensitivity and construct validity issues, *Journal of Human Factor*, 2019c.
- [183] Yao, Y., Rakheja S., Marcotte P., Distributed vibration isolation and manual dexterity of anti-vibration gloves: Is there a correlation, *Journal of Ergonomics*, 2019a.

- [184] C. Chen. Applying the analytical hierarchy process (AHP) approach to convention site selection. *Journal of Travel Research* 45(2), pp. 167-174. 2006.
- [185] T. L. Saaty. Transport planning with multiple criteria: The analytic hierarchy process applications and progress review. *J. Adv. Transport.* 29(1), pp. 81-126. 1995.
- [186] N. H. Zardari, K. Ahmed, S. M. Shirazi and Z. B. Yusop. *Weighting Methods and their Effects on Multi-Criteria Decision Making Model Outcomes in Water Resources Management* 2015.
- [187] A. Mohideen and S. Sidek. Development of EMG circuit to study the relationship between flexor digitorum superficialis muscle activity and hand grip strength. Presented at 2011, 4th International Conference on Mechatronics (ICOM). 2011, .
- [188] B. J. Winer, D. R. Brown and K. M. Michels. *Statistical Principles in Experimental Design* 19712.
- [189] R. N. Cardinal and M. R. Aitken. *ANOVA for the Behavioral Sciences Researcher* 2013.
- [190] R. E. Lana and A. Lubin. The effect of correlation on the repeated measures design. *Educational and Psychological Measurement* 23(4), pp. 729-739. 1963.
- [191] J. Gaito. Repeated measurements designs and counterbalancing. *Psychol. Bull.* 58(1), pp. 46. 1961.
- [192] R. B. McCall and M. I. Appelbaum. Bias in the analysis of repeated-measures designs: Some alternative approaches. *Child Dev.* pp. 401-415. 1973.
- [193] N. J. Salkind. *Encyclopedia of Research Design* 20101.
- [194] D. E. Hinkle, W. Wiersma and S. G. Jurs. *Applied Statistics for the Behavioral Sciences* 2003663.
- [195] T. D. Wickens and G. Keppel. *Design and Analysis: A Researcher's Handbook* 2004.
- [196] M. Puth, M. Neuhäuser and G. D. Ruxton. Effective use of pearson's product–moment correlation coefficient. *Anim. Behav.* 93 pp. 183-189. 2014.
- [197] M. Stone. Introductory engineering statistics. *Journal of the Royal Statistical Society: Series A (General)* 136(2), pp. 262-262. 1973.
- [198] R. F. Haase and M. V. Ellis. Multivariate analysis of variance. *Journal of Counseling Psychology* 34(4), pp. 404. 1987.
- [199] S. McQuitty. The purposes of multivariate data analysis methods: An applied commentary. *J. Afr. Bus.* 19(1), pp. 124-142. 2018.

[200] J. H. Bray and S. E. Maxwell. Analyzing and interpreting significant MANOVAs. *Review of Educational Research* 52(3), pp. 340-367. 1982.

[201] J. H. Bray, S. E. Maxwell and S. E. Maxwell. *Multivariate Analysis of Variance* 1985(54).

[202] C. R. Rao. Advanced statistical methods in biometric research. *New York* pp. 351-382. 1952.